

# AMIS-30422

## Micro-Stepping Stepper Motor Bridge Controller

### Introduction

The AMIS-30422 is a micro-stepping stepper motor bridge controller for large current range bipolar applications. The chip interfaces via a SPI interface with an external controller in order to control two external power NMOS H-bridges. It has an on-chip voltage regulator, current sensing, self adapting PWM controller and pre-driver with smart slope control switching allowing the part to be EMC compliant with industrial and automotive applications. It uses a proprietary PWM algorithm for reliable current control.

The AMIS-30422 contains a current translation table and takes the next micro-step depending on the clock signal on the “NXT” input pin and the status of the “DIR” (direction) register or input pin. The chip provides a so-called “Speed and Load Angle” output. This allows the creation of stall detection algorithms and control loops based on load angle to adjust torque and speed.

The AMIS-30422 is implemented in a mature technology, enabling fast high voltage analog circuitry and multiple digital functionalities on the same chip. The chip is fully compatible with automotive voltage requirements.

The AMIS-30422 is easy to use and ideally suited for large current stepper motor applications in the automotive, industrial, medical and marine environment. With the on-chip voltage regulator it further reduces the BOM for mechatronic stepper applications.

### Key Features

- Dual H-Bridge Pre-Drivers for 2-Phase Stepper Motors
- Programmable Current via SPI
- On-chip Current Translator
- SPI Interface
- Speed and Load Angle Output
- 9 Step Modes from Full Step up to 128 Micro-Steps
- Current-Sense via Two External Sense Resistors
- PWM Current Control with Automatic Selection of Fast and Slow Decay
- Low EMC PWM with Selectable Voltage Slopes
- Full Output Protection and Diagnosis
- Thermal Warning and Shutdown
- Compatible with 3.3 V Microcontrollers
- Integrated 3.3 V Regulator to Supply External Microcontroller
- Integrated Reset Function to Reset External Microcontroller
- Integrated Watchdog Function
- These Devices are Pb-Free and are RoHS Compliant



ON Semiconductor®

<http://onsemi.com>

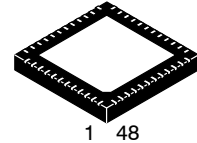

QFN48  
CASE 485AJ

### MARKING DIAGRAM

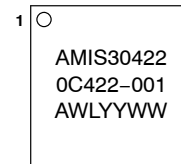

A = Assembly Location  
WL = Wafer Lot  
YY = Year  
WW = Work Week  
G = Pb-Free Package

### ORDERING INFORMATION

See detailed ordering and shipping information in the package dimensions section on page 44 of this data sheet.

# AMIS-30422

## BLOCK DIAGRAM

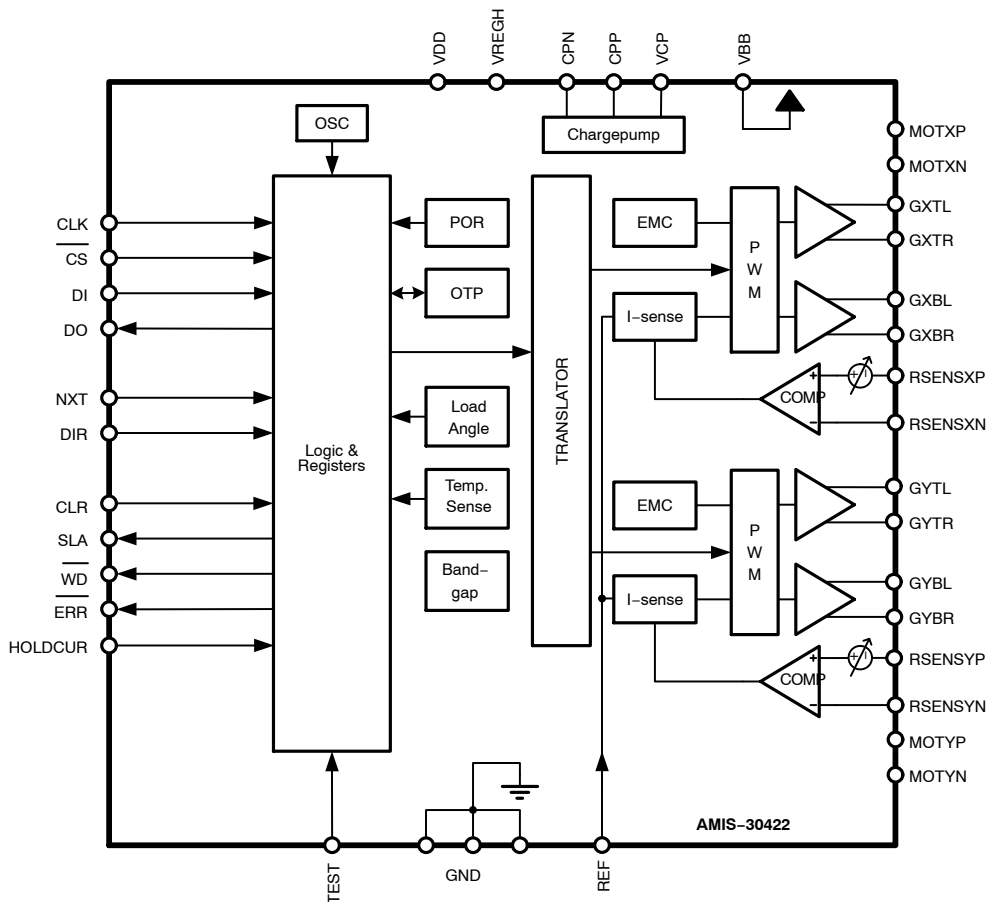

Figure 1. Block Diagram AMIS-30422

## PIN OUT

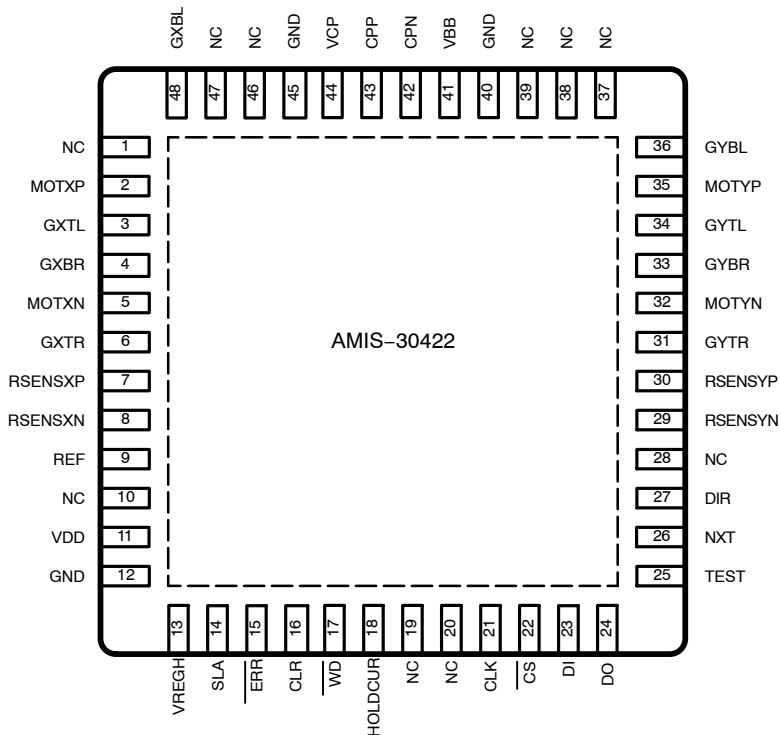

Figure 2. Pin Out AMIS-30422

Table 1. PIN LIST AND DESCRIPTION

Name	Pin	Description	Type	Equivalent Schematic
MOTXP	2	Positive end of phase X-coil	Analog I/O	
GXTL	3	Gate of external NMOS FET of the X bridge top left side	Analog Output	
GXBR	4	Gate of external NMOS FET of the X bridge bottom right side	Analog Output	
MOTXN	5	Negative end of phase X-coil	Analog I/O	
GXTR	6	Gate of external NMOS FET of the X bridge top right side	Analog Output	
RSENSXP	7	Resistor sense of the X bridge positive pin	Analog Input	
RSENSXN	8	Resistor sense of the X bridge negative pin	Analog Input	
REF	9	Maximum Coil Current Setting	Analog Input	Type 7
VDD	11	Low voltage supply output (needs external decoupling capacitor)	Supply	Type 8
GND	12	Ground, heat sink	Supply	
VREGH	13	High voltage supply output	Analog output	
SLA	14	Speed and Load Angle output	Analog output	Type 6
ERRb	15	Error output	Digital Output	Type 2 or 4
CLR	16	Clear input	Digital Input	Type 5
WDb	17	Watchdog and Power On Reset output	Digital Output	Type 2 or 4
HOLDCUR	18	Hold Current Input	Digital Input	
CLK	21	SPI Clock input	Digital Input	Type 1
CSb	22	SPI Chip Select input	Digital Input	Type 3
DI	23	SPI Data input	Digital Input	Type 1
DO	24	SPI Data output	Digital Output	Type 4
TEST	25	Test input. To be tied to ground.	Digital Input	Type 1
NXT	26	Next Microstep input	Digital Input	Type 1
DIR	27	Direction input	Digital Input	Type 1
RSENSYN	29	Resistor sense of the Y bridge negative pin	Analog Input	
RSENSYP	30	Resistor sense of the Y bridge positive pin	Analog Input	
GYTR	31	Gate of external NMOS FET of the Y bridge top right side	Analog Output	
MOTYN	32	Negative end of phase Y-coil	Analog I/O	
GYBR	33	Gate of external NMOS FET of the Y bridge bottom right side	Analog Output	
GYTL	34	Gate of external NMOS FET of the Y bridge top left side	Analog Output	
MOTYP	35	Positive end of phase Y-coil	Analog I/O	
GYBL	36	Gate of external NMOS FET of the Y bridge bottom left side	Analog Output	
GND	40	Ground, heat sink	Supply	
VBB	41	High voltage supply input	Supply	Type 9
CPN	42	Negative connection of charge pump capacitor	Analog I/O	
CPP	43	Positive connection of charge pump capacitor	Analog I/O	
VCP	44	Charge Pump filter capacitor	Analog I/O	
GND	45	Ground, heat sink	Supply	
GXBL	48	Gate of external NMOS FET of the X bridge bottom left side	Analog Output	
NC	1, 10, 19, 20, 28, 37, 38, 39, 46, 47	Not connected or connect with ground		

NOTE: Output type of WDb- and ERRb-pin is selectable through SPI.

EQUIVALENT SCHEMATICS

Following figure gives the equivalent schematics of the user relevant inputs and outputs. The diagrams are simplified representations of the circuits used.

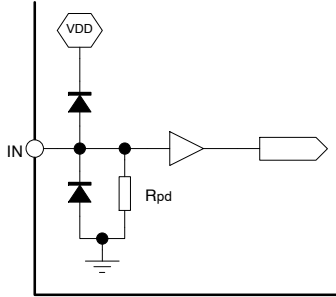

TYPE 1: CLK, DI, NXT, DIR, TEST Input

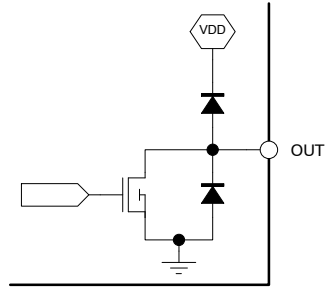

TYPE 2: WDb, ERRb Open Drain Output

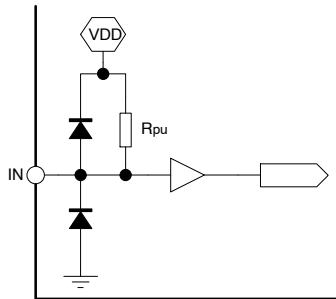

TYPE 3: CSb Input

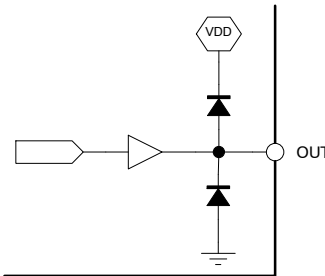

TYPE 4: DO, WDb, ERRb Push Pull Output

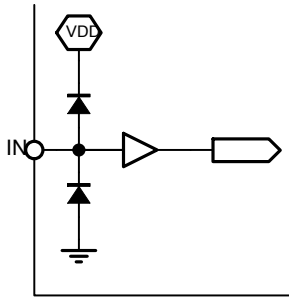

TYPE 5:

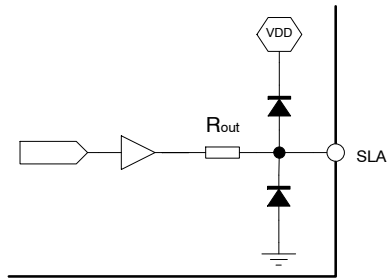

TYPE 6: SLA Analog Output

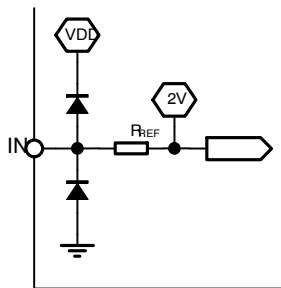

TYPE 7:

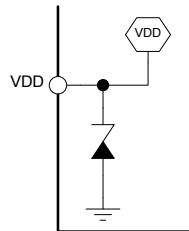

TYPE 8: VDD Power Supply

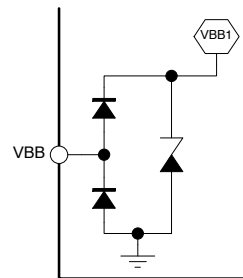

TYPE 9: VBB Power Supply

NOTE: Output type of WDb- and ERRb-pin is selectable through SPI, DO-pin is push-pull output with tristate

Figure 3. In- and Output Equivalent Diagrams

ELECTRICAL SPECIFICATION

Table 2. ABSOLUTE MAXIMUM RATINGS (Notes 1 and 2)

Symbol	Parameter	Min	Max	Unit
V <sub>BB</sub>	Analog DC supply voltage (Note 3)	-0.3	+40	V
I <sub>load</sub>	Logic supply external load current, Normal Mode	0	-10	mA
	Logic supply external load current, Sleep Mode	0	-1	mA
V <sub>RENS</sub>	Voltage on pins RSENSXP, RSENSXN, RSENSYP and RSENSYN	-2.0	+2.0	V
V <sub>LVI0</sub>	Voltage on digital I/O pins, REF-pin and SLA-pin	-0.3	3.6	V
			V <sub>DD</sub> + 0.3	
I <sub>SLA</sub>	Load current on SLA-pin	0	-40	μA
T <sub>ST</sub>	Storage temperature	-55	+160	°C
T <sub>J</sub>	Junction Temperature under bias (Note 4)	-50	+175	°C
V <sub>HBM</sub>	Human Body Model electrostatic discharge immunity (Note 5)	-2	+2	kV
V <sub>HBM</sub>	Human Body Model electrostatic discharge immunity, high voltage pins (Note 6)	-4	+4	kV
V <sub>MM</sub>	Machine Model electrostatic discharge immunity (Note 7)	-150	+150	V
V <sub>CDM</sub>	Charge Device Model electrostatic discharge immunity (Note 8)	-500	+500	V

Stresses exceeding Maximum Ratings may damage the device. Maximum Ratings are stress ratings only. Functional operation above the Recommended Operating Conditions is not implied. Extended exposure to stresses above the Recommended Operating Conditions may affect device reliability.

1. If more than one value is mentioned, the most stringent applies.
2. Convention: currents flowing in the circuit are defined as positive.
3. +36 V < V<sub>BB</sub> < +40 V limited to 1 day over lifetime
4. Circuit functionality not guaranteed.
5. According to JESD-A114
6. High Voltage Pins MOTxx, VBB, GND; According to JESD-A114
7. According to JESD-A114
8. According to STM5.3.1-1999

RECOMMEND OPERATION CONDITIONS

Operating ranges define the limits for functional operation and parametric characteristics of the device. Note that the functionality of the chip outside these operating ranges is not guaranteed. Operating outside the recommended operating ranges for extended periods of time may affect device reliability.

Table 3. OPERATING RANGES

Symbol	Parameter	Min	Max	Unit
V <sub>BB</sub>	Analog DC supply	+6	+30	V
V <sub>DD</sub>	Logic Supply Output Voltage (Normal Mode)	+3.0	+3.6	V
T <sub>J</sub>	Junction temperature (Note 9)	-40	+125	°C

9. High junction temperature can result in reduced lifetime.

**Table 4. DC PARAMETERS**

The DC parameters are given for  $V_{BB}$  and temperature in their operating ranges unless otherwise specified.  
 Convention: currents flowing in the circuit are defined as positive.

Symbol	Pin(s)	Parameter	Remark/Test Conditions	Min	Typ	Max	Unit	
<b>SUPPLY &amp; VOLTAGE REGULATOR</b>								
$V_{BB}$	VBB	Nominal operating supply range		6		30	V	
$I_{BB}$		Total internal current consumption	Unloaded outputs, internal consumption included, H-bridge disabled			20	mA	
$I_{SLEEP}$		Sleep mode current consumption	Unloaded outputs, CSb = $V_{DD}$			150	$\mu$ A	
$V_{DD}$	VDD	Regulated Output Voltage	$-10\text{ mA} \leq I_{load} \leq 0\text{ mA}$	3.1	3.3	3.5	V	
$V_{DD\_SLEEP}$		Regulated Output Voltage in Sleep	$-1\text{ mA} \leq I_{load} \leq 0\text{ mA}$	2.1	2.95	3.63	V	
$I_{LOAD}$		External load current				-10	mA	
$I_{DDLIM}$		Current limitation	Pin shorted to ground		-20		-80	mA
$I_{LOAD\_PD}$		Output current in sleep					-1	mA
$V_{REGH}$	VREGH	High voltage regulator	$V_{BBLV} \leq V_{BB} \leq 30\text{ V}$ Based on Figure 9 H-bridge disabled $13.25\text{ V} \leq V_{BBLV} \leq 15.75\text{ V}$	11.2	12.0	12.8	V	
			$6\text{ V} \leq V_{BB} < V_{BBLV}$ Based on Figure 9 H-bridge disabled $13.25\text{ V} \leq V_{BBLV} \leq 15.75\text{ V}$			$V_{BB}$	V	

**POWER ON RESET (POR)**

$V_{DDH}$	VDD	Internal POR comparator threshold	$V_{DD}$ rising, see Figure 4	1.44	1.8	2.53	V
$V_{DDL}$		Internal POR comparator threshold	$V_{DD}$ falling, see Figure 4	1.16	1.5	1.93	
$V_{DDhys}$		Internal POR comparator hysteresis			0.3		

**UNDERVOLTAGE**

$V_{BBUH}$	VBB	$V_{BB}$ undervoltage release level	$V_{BB}$ rising, see Figure 5	5.5		6.5	V
$V_{BBUL}$		$V_{BB}$ undervoltage trigger level	$V_{BB}$ falling, see Figure 5	5.3		6.3	
$V_{BBUhys}$		$V_{BB}$ undervoltage hysteresis			0.25		

**PRE-DRIVER**

$I_{ON}$	GXTR, GXTL, GXBR, GXBL, GYTR, GYTL, GYBR, GYBL	Gate charge current	Selectable through SPI	-3		-33	mA
$I_{OFF}$		Gate discharge current	Selectable through SPI	3		33	mA
$R_{SW}$		Switch On-resistance	See also Figure 10		10	25	$\Omega$

**Table 4. DC PARAMETERS**

The DC parameters are given for  $V_{BB}$  and temperature in their operating ranges unless otherwise specified.  
Convention: currents flowing in the circuit are defined as positive.

Symbol	Pin(s)	Parameter	Remark/Test Conditions	Min	Typ	Max	Unit	
<b>PRE-DRIVER</b>								
$V_{SENS}$	RSENSxx	PWM comparator toggle level	Selectable through SPI	1/40		1/5	$V_{REF}$	
$V_{SENS\_Tol}$		PWM comparator toggle level tolerance		-22		+22	%	
<b>REF INPUT</b>								
$V_{REF}$	REF	REF input voltage		0		$V_{DD}$	V	
$V_{REF\_Range}$		REF input voltage range		0.25		2	V	
$V_{REF\_TOL}$		Tolerance on maximum $V_{REF\_Range}$		-10		+10	%	
$I_{REF\_LEAK}$		REF input leakage	$V_{REF} \leq 1.8 V$		-1		1	$\mu A$
$R_{REF}$		REF input impedance	See also Figure 3		10	20	30	$k\Omega$
<b>DIGITAL INPUTS</b>								
$V_{IL}$	CLK, DI, CSb, NXT, DIR, CLR, HOLDCLR	Logic Low Threshold		0		$0.3 \times V_{DD}$	V	
$V_{IH}$		Logic High Threshold		$0.7 \times V_{DD}$		$V_{DD}$	V	
$R_{pd}$		Internal Pull Down Resistor	Csb and CLR excluded, See also Figure 3	250		1100	$k\Omega$	
$R_{pu}$	CSb	Internal Pull Up Resistor	See also Figure 3	250		1100	$k\Omega$	
<b>DIGITAL OUTPUTS</b>								
$V_{OL}$	DO, ERRb, WDb	Logic low output level	Output set to type 4 (see Figure 3)			0.5	V	
$V_{OH}$		Logic high output level		$V_{DD} - 0.5$				
$V_{OL\_OPEN}$		Logic Low level open drain	$I_{OL} = 8 mA$ , Output set to type 2 (see Figure 3), DO excluded			0.5		
<b>SPEED AND LOAD ANGLE OUTPUT</b>								
$V_{out}$	SLA	Output Voltage Range		0.5		$V_{DD} - 0.5$	V	
$V_{off}$		Output Offset SLA-pin	Selectable through SPI	0.6		1.2	V	
$V_{off\_tol}$		Tolerance on SLA output offset		-17		+17	%	
$G_{SLA}$		Gain of SLA-pin = $V_{BEMF} / V_{SLA}$	Selectable through SPI	0.0625		1		
$G_{SLA\_tol}$		Tolerance on SLA gain		-10		+10	%	
$R_{out}$		Output Resistance SLA-pin	See also Figure 3			1	$k\Omega$	
$I_{SLA\_load}$		Load current SLA-pin		0		-40	$\mu A$	
<b>THERMAL WARNING &amp; SHUTDOWN</b>								
$T_1$		Trigger level thermal range 1	See Figure 21	-5	15	35	$^{\circ}C$	
$T_2$		Trigger level thermal range 2	See Figure 21	55	70	85	$^{\circ}C$	
$T_3$		Trigger level thermal range 3	See Figure 21	138	150	162	$^{\circ}C$	
$T_{TW}$		Thermal Warning	See Figure 21	138	150	162	$^{\circ}C$	
$T_{TSD}$		Thermal shutdown	See Figure 21		$T_{TW} + 20$		$^{\circ}C$	
<b>CHARGE PUMP</b>								
$V_{CP} - V_{BB}$	VCP	Chargepump overdrive voltage	Based on Figure 9	3.5	$V_{BB} - 2.5$	15.75	V	
$V_{CPP} - V_{CPN}$		Chargepump pumping voltage		3.5	$V_{BB} - 2.5$	15.75	V	
$C_{pump}$		External pump capacitor	See also $C_2$ Figure 9		220		nF	
$C_{buffer}$	CPP CPN	External buffer capacitor	See also $C_3$ Figure 9		220		nF	

**Table 4. DC PARAMETERS**

The DC parameters are given for  $V_{BB}$  and temperature in their operating ranges unless otherwise specified.  
Convention: currents flowing in the circuit are defined as positive.

Symbol	Pin(s)	Parameter	Remark/Test Conditions	Min	Typ	Max	Unit
<b>PACKAGE THERMAL RESISTANCE VALUE</b>							
$R_{thja}$		Thermal Resistance Junction-to-Ambient	Simulated Conform JEDEC JESD-51, (2S2P)		30		K/W
			Simulated Conform JEDEC JESD-51, (1S0P)		60		K/W
$R_{thjp}$		Thermal Resistance Junction-to-Exposed Pad			0.95		K/W

**Table 5. AC PARAMETER** The AC parameters are given for  $V_{BB}$  and temperature in their operating ranges unless otherwise specified.

Symbol	Pin(s)	Parameter	Remark/Test Conditions	Min	Typ	Max	Unit
<b>INTERNAL OSCILLATOR</b>							
$f_{osc}$		Frequency of internal oscillator		6.4	8	9.6	MHz
<b>POWER-UP</b>							
$t_{PU}$	POR	Power-up time	$C_{VDD} = 200 \text{ nF}$ , See Figure 4			60	$\mu\text{s}$
$t_{POR}$		Reset duration	See Figure 4	80	100	120	ms
$t_{RF}$		Reset filter time	See Figure 4	1		15	$\mu\text{s}$
$t_{DSPI}$		SPI Delay	See Figure 4			500	$\mu\text{s}$
<b>PREDRIVER</b>							
$f_{PWM}$		PWM frequency	Frequency depends only on internal oscillator	20	25	30	kHz
$t_1$		Bridge MOSFET switch on time $t_1$	Selectable through SPI. See Figure 11.	375		1250	ns
$t_2$		Bridge MOSFET switch on time $t_2$	Selectable through SPI. See Figure 11.	1250		4750	ns
$t_{off}$		Bridge MOSFET switch off time	Selectable through SPI. See Figure 11.	1250		4750	ns
$t_{switch\_tol}$		Bridge MOSFET switch on/off tolerance		-20		+20	%
$t_{open}$		Open circuit time out	Selectable through SPI	0.32		163.84	ms
$t_{open\_acc}$		Open circuit time out accuracy		-20		+20	%
$t_{nocross}$		Non overlap time	Selectable through SPI	0		500	ns
$t_{nocross\_acc}$		Non overlap accuracy		-20		+20	%



**Table 5. AC PARAMETER** The AC parameters are given for  $V_{BB}$  and temperature in their operating ranges unless otherwise specified.

Symbol	Pin(s)	Parameter	Remark/Test Conditions	Min	Typ	Max	Unit
<b>DIGITAL INPUTS</b>							
$t_{NXT\_HI}$		NXT Minimum, high pulse width	See Figure 6	625			ns
$t_{NXT\_LO}$		NXT Minimum, low pulse width		625			ns
$t_{DIR\_SET}$		NXT set up time, following change of DIR or <DIRCTRL>		1.28			$\mu$ s
$t_{DIR\_HOLD}$		NXT hold time, before change of DIR or <DIRCTRL>		1.28			$\mu$ s
$t_{SLP\_SET}$		<SLP> set up time		300			$\mu$ s
$t_{SLP\_HOLD}$		<SLP> hold time		1			$\mu$ s
$t_{MOTEN\_SET}$		<MOTEN> set up time		1			$\mu$ s
$t_{MOTEN\_HOLD}$		<MOTEN> hold time		1.28			$\mu$ s
$t_{MSP}$		<MSP[7:0]> update delay			1.28	$\mu$ s	
<b>CLEAR FUNCTION</b>							
$t_{CLR\_SET}$	CLR	Clear set up time	See Figure 7	40			$\mu$ s
$t_{CLR}$		Clear duration time	See Figure 7	20		90	$\mu$ s
<b>DIGITAL OUTPUTS</b>							
$t_{H2L}$	DO, WDb, ERRb	Output fall-time from $V_{OH}$ to $V_{OL}$	Output type 2, capacitive load 400 pF and pull-up resistor of 1.5 k $\Omega$			50	ns
<b>WATCHDOG</b>							
$t_{WDPR}$		Prohibited watchdog acknowledge time				2.5	ms
$t_{WDTO}$		Watchdog time out interval		32		512	ms
$t_{WDTO\_acc}$		Watchdog time out accuracy		-20		+20	%
$t_{WDRD}$		Watchdog Reset Delay				500	ns
<b>SERIAL PERIPHERAL INTERFACE (SPI)</b>							
$t_{CLK}$	CLK	SPI Clock period	See Figure 8	1			$\mu$ s
$t_{CLK\_HIGH}$		SPI Clock high time		100			ns
$t_{CLK\_LOW}$		SPI Clock low time		100			ns
$t_{DI\_SET}$	DI	SPI Data Input set up time		50			ns
$t_{DI\_HOLD}$		SPI Data Input hold time		50			ns
$t_{CS\_HIGH}$	CSb	SPI Chip Select high time		2.5			$\mu$ s
$t_{CS\_SET}$		SPI Chip Select set up time		100			ns
$t_{CS\_HOLD}$		SPI Chip Select hold time		100			ns
<b>SPEED AND LOAD ANGLE OUTPUT</b>							
$t_{SLA\_DELAY}$	SLA	SLA output update delay	Not-transparent Mode See Figure 19			60	$\mu$ s
$t_{MinSLA}$		Minimum zero crossing time	Selectable through SPI	40		360	$\mu$ s
$t_{MinSLA\_Acc}$		Minimum zero crossing accuracy		-20		+20	%
<b>CHARGE PUMP</b>							
$f_{CP}$	CPN CPP	Charge pump frequency		160	200	240	kHz
$t_{CPU}$	MOTxx	Start-up time of charge pump	Spec external components in Table 4		250		$\mu$ s

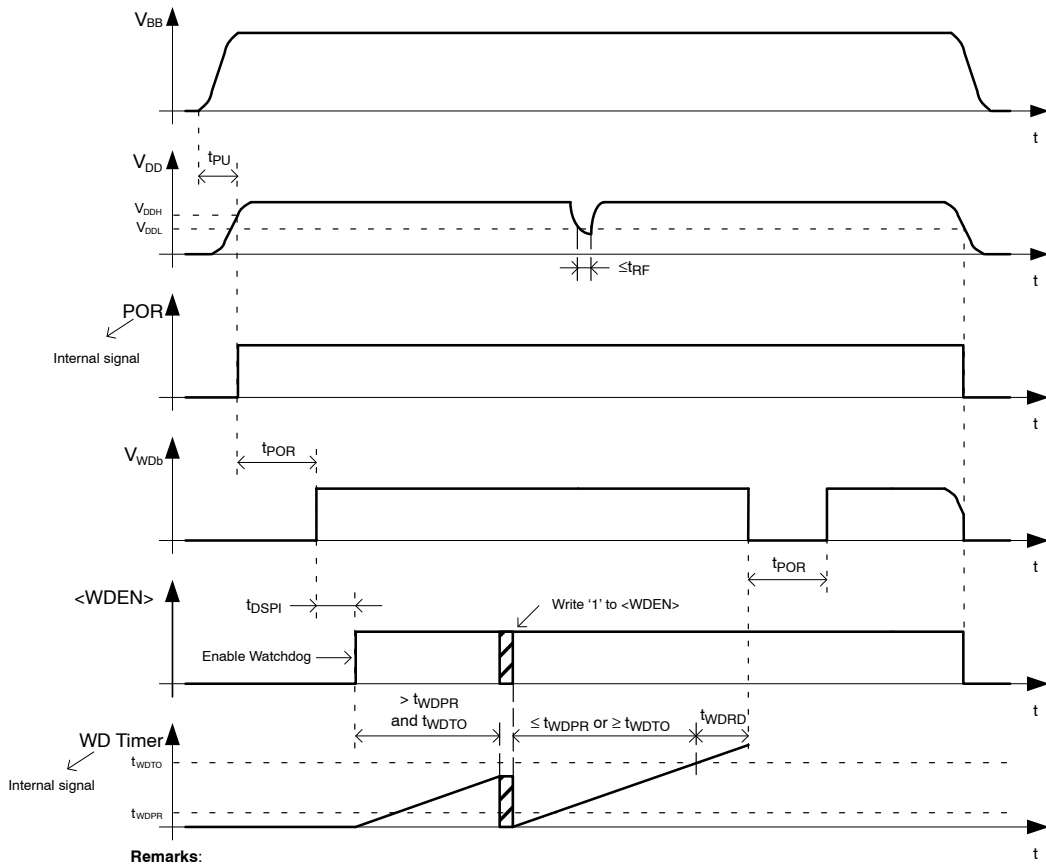

**Remarks:**  
 -WDb-pin pulled up to V<sub>DD</sub>  
 - $t_{WDTO} = \langle WDT[3:0] \rangle$   
 - $\langle WDEN \rangle$  and  $\langle WDT[3:0] \rangle$  are SPI bits

Figure 4. Power-On-Reset Timing Diagram

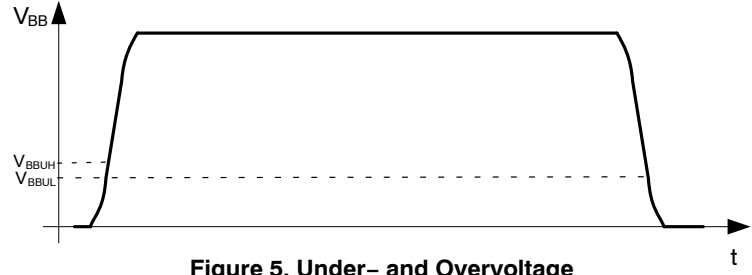
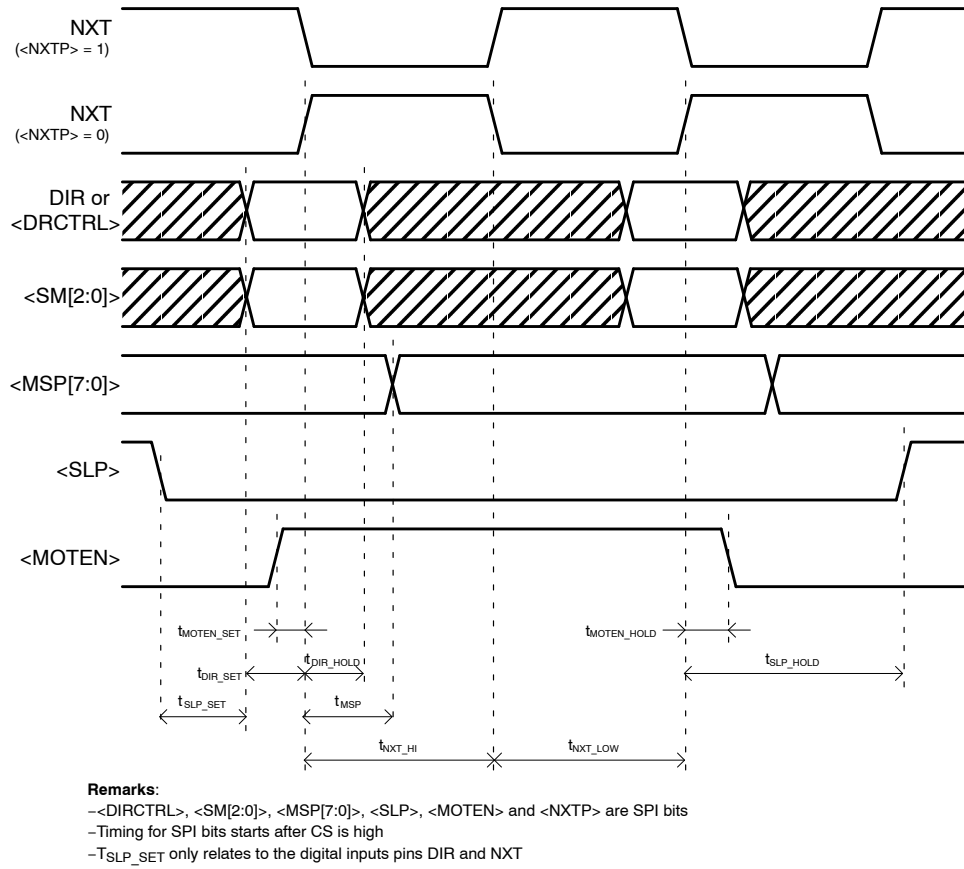
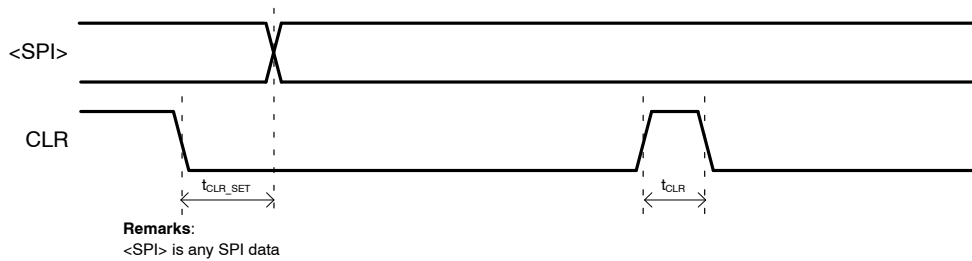

Figure 5. Under- and Overvoltage

# AMIS-30422



**Figure 6. Digital Input Timing Diagram**



**Figure 7. CLR-pin Timing Diagram**

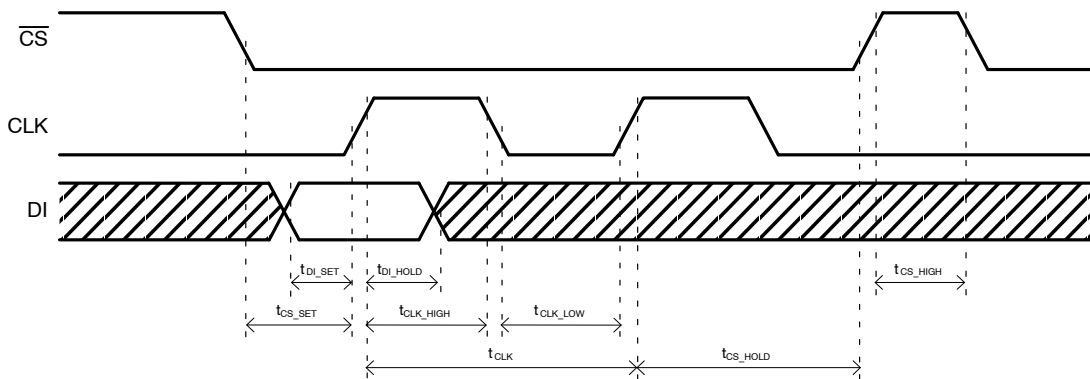

**Figure 8. SPI Bus Timing Diagram**

# AMIS-30422

## TYPICAL APPLICATION SCHEMATIC

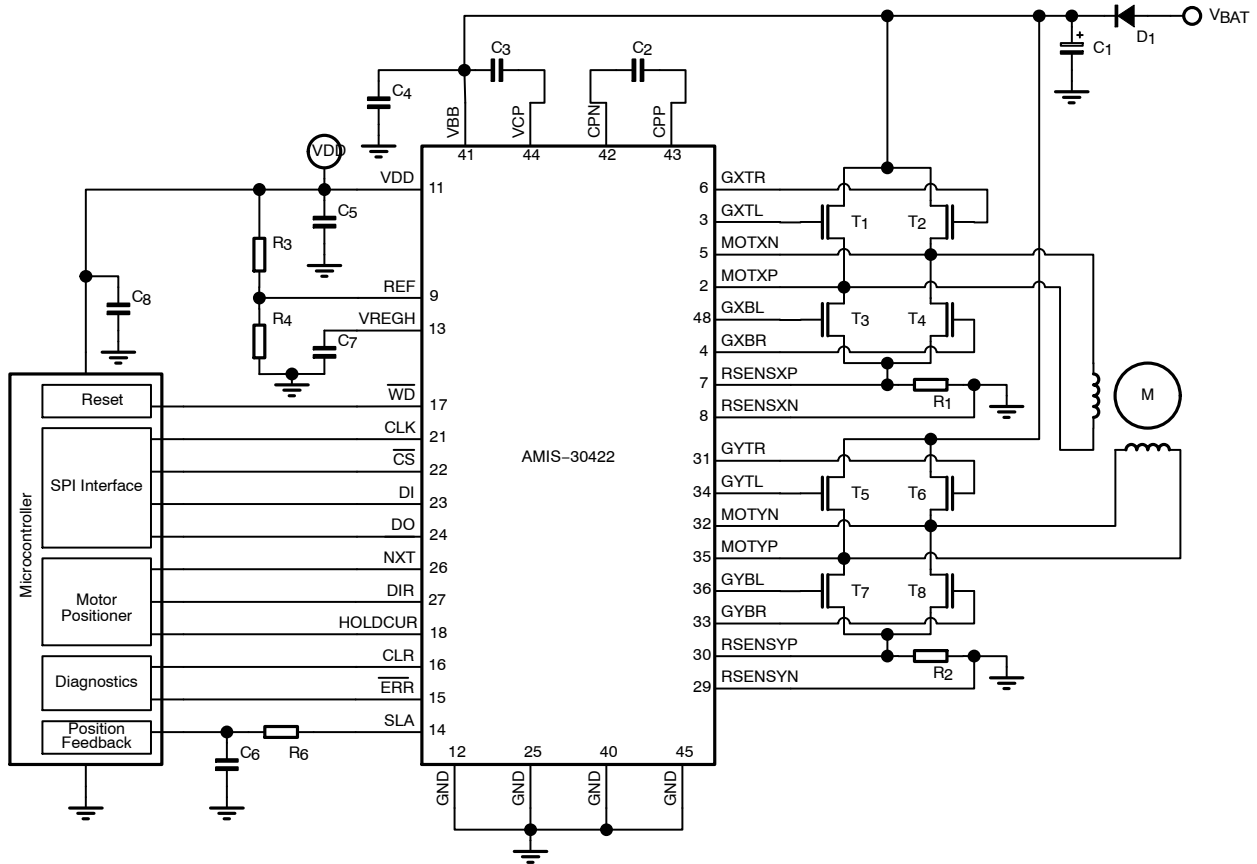

Figure 9. Typical Application Schematic AMIS-30422

Table 6. EXTERNAL COMPONENTS LIST AND DESCRIPTION

Component	Function	Typ Value	Tolerance	Unit
C <sub>1</sub>	V <sub>BB</sub> buffer capacitor (Note 10)	100	±20%	μF
C <sub>2</sub>	Charge-pump pumping capacitor	220	± 20%	nF
C <sub>3</sub>	Charge-pump buffer capacitor	220	±20%	nF
C <sub>4</sub>	V <sub>BB</sub> decoupling capacitor (Note 11)	100	±20%	nF
C <sub>5</sub> , C <sub>8</sub>	V <sub>DD</sub> buffer capacitor	100	±20 %	nF
C <sub>6</sub>	Low pass filter SLA	1	±20%	nF
C <sub>7</sub>	VREGH buffer capacitor	4.7	±20%	uF
R <sub>1</sub> , R <sub>2</sub>	Sense Resistors	>25	±1%	mΩ
R <sub>3</sub> , R <sub>4</sub>	Coil Current Peak Setting	Depending on desired voltage on REF-pin		
R <sub>6</sub>	Low pass filter SLA	5.6	±1%	kΩ
D <sub>1</sub>	Optional reverse protection diode	MBRD1045		
T <sub>1</sub> ... T <sub>8</sub>	H-Bridge N-MOSFET	NTD4815N or NTD4813N or NTD40N03R or NTD5807N		

10. ESR < 1 Ω.

11. ESR < 50 mΩ.

FUNCTIONAL DESCRIPTION

H-Bridge Pre-Drivers

The H-bridge pre-drivers for external N-type MOSFETs are controlled by means of current sources for slope regulation (Figure 10). The current source value can be set through SPI (see p41 and further). During the MOSFET switch-on and switch-off phase this current source will be applied for a certain time (respectively  $t_{on}$  and  $t_{off}$  where  $t_{on}$  is divided in  $t_1$  and  $t_2$ ). After this time ( $t_{on}$  or  $t_{off}$ ) the gate of the MOSFET is pulled high or low by means of a switch ( $SW_{on}$  or  $SW_{off}$ ). The timings can also be set through SPI (see p41 and further).

To prevent short circuits, an additional time  $t_{nocross}$  can be added between switching off one MOSFET and switching on the other MOSFET of a half H-bridge (SPI bits  $\langle NO\_CROSS[1:0] \rangle$ ).

More information on the current sources and timings can be found in Table 5. A detailed description of the SPI settings for the H-bridge pre-drivers can be found at p35 and further.

Figure 11 gives a detailed view on the different stages during switching of the MOSFET.

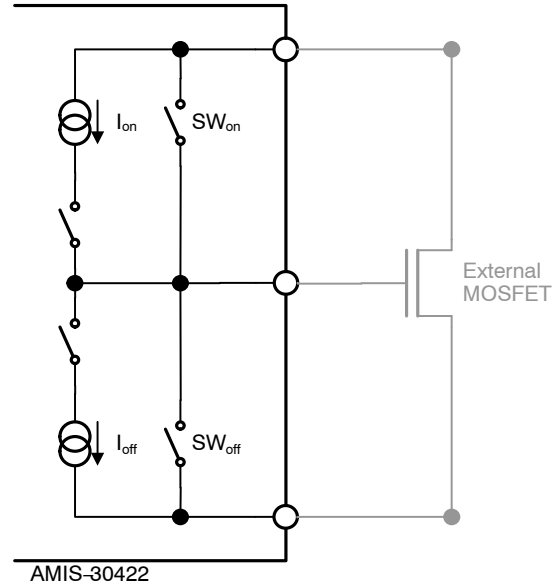

Figure 10. Pre-driver Topology

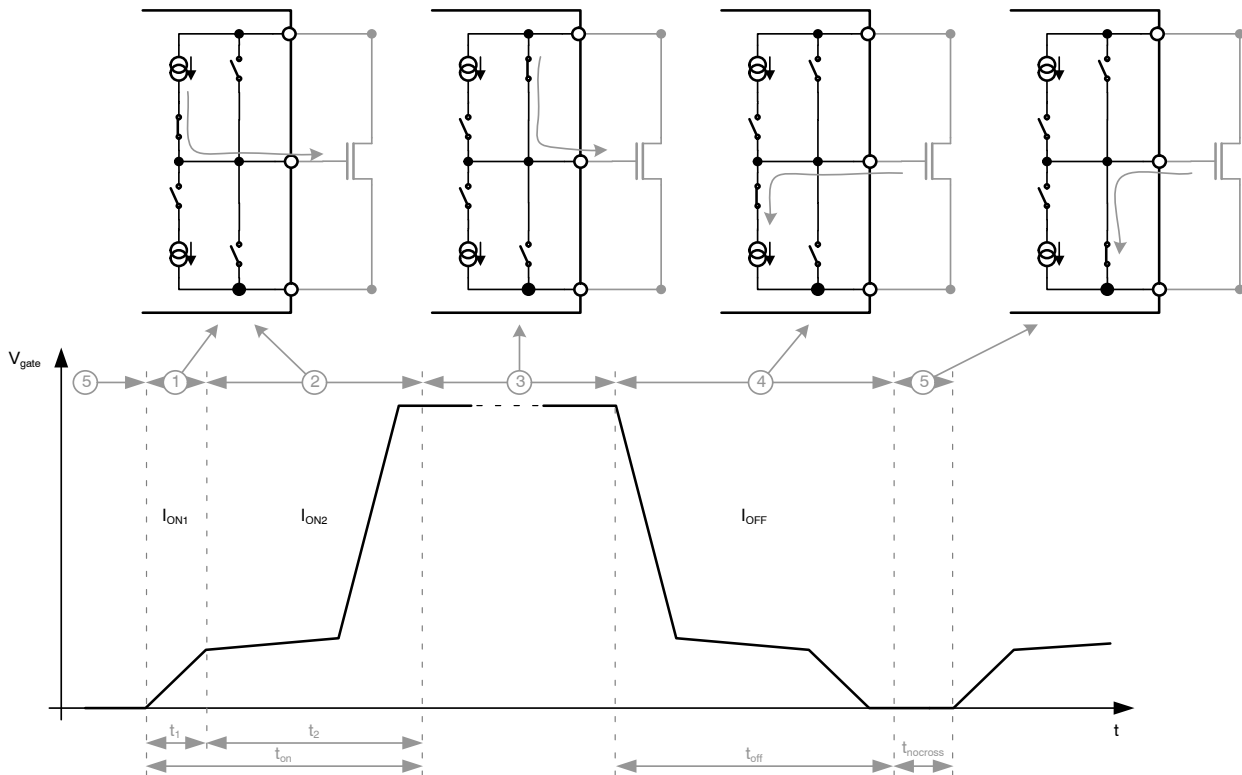

Figure 11. Detailed View on MOSFET Switching

**PWM Current Control**

A PWM comparator compares continuously the actual winding current (measured over the external sense resistor) with the requested current and feeds back the information to a digital regulation loop. This loop then generates a PWM signal, which turns on/off the current sources ( $I_{on}$ ,  $I_{off}$ ) and switches ( $SW_{on}$ ,  $SW_{off}$ ). The switching points of the PWM duty-cycle are synchronized to the on-chip PWM clock. The frequency of the PWM controller is fixed and will not vary with changes in the supply voltage. Also variations in motor-speed or load-conditions of the motor have no effect. There are no external components required to adjust the PWM frequency.

For EMC reasons it's possible to add jitter to the PWM by means of the <PWMJ> bit.

**Step Translator and Step Mode**

The step translator provides the control of the motor by means of the stepmode SPI bits <SM[3:0]>, the enable SPI

bit <MOTEN>, the direction SPI bit <DIRCTRL> and input pins DIR and NXT. It is translating consecutive steps in corresponding currents in both motor coils for a given step mode. One out of 9 possible stepping modes can be selected through SPI bits <SM[3:0]>.

After power-up or clear (CLR-pin) the coil current translator is set to position 0. For all stepping modes except full step this means that the coil current is maximum in the Y-coil and zero in the X-coil (see Table 7). If NXT pulses are applied when the DIR-pin is pulled low, SPI bit <DIRCTRL> is zero and SPI bit <MOTEN> is one, the coil current translator will step through Table 7 from top till bottom. If DIR-pin is pulled high or SPI bit <DIRCTRL> is set to '1', the coil current translator will step in opposite direction through the table.

Figures 12 up to 15 gives another view on the different stepping modes. The Y-coil current is plotted on the Y-axis, the X-coil current on the X-axis.

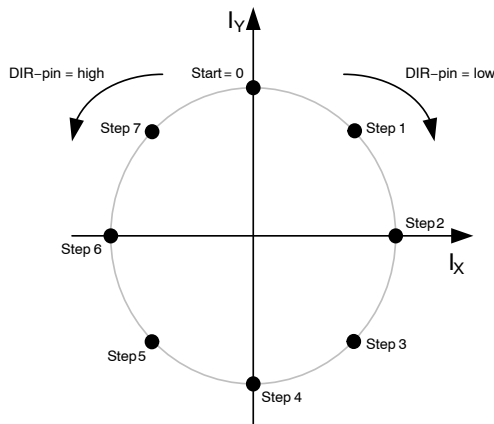

Figure 12. Half-step

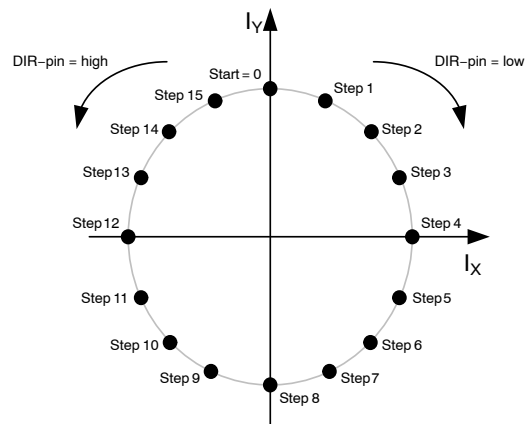

Figure 13. 1/4 Microstepping

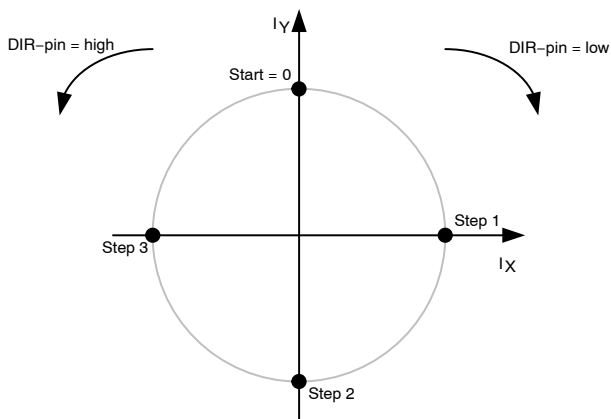

Figure 14. Full-Step 1/2 Rotated

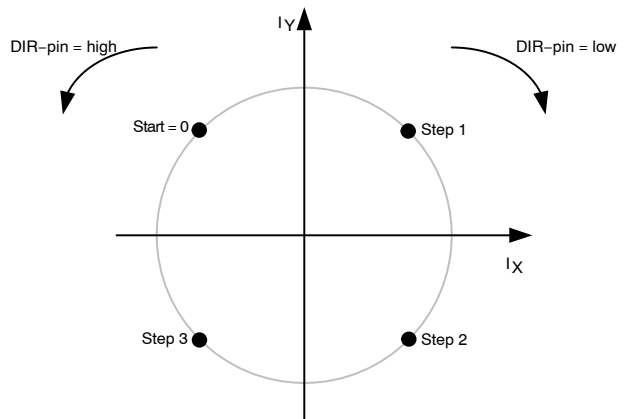

Figure 15. Full-step

**Remark:**

- ◆ Positive coil current flows from MOTXP to MOTXN and MOTYP to MOTYN.
- ◆ In above figures SPI bit <DIRCTRL> is set to '0'. When set to '1', rotation will be reversed.

Table 7. CIRCULAR TRANSLATOR TABLE

Stepmode(< SM[3:0]>)									% of I <sub>max</sub>	
0000	0001	0010	0011	0100	0101	0110	0111	1111	Coil X	Coil Y
1/128	1/64	1/32	1/16	1/8	1/4	1/2	Full Step	Full Step + 1/2 rotation		
0	0	0	0	0	0	0	-	0	0	100
1	-	-	-	-	-	-	-	-	1	100
2	1	-	-	-	-	-	-	-	2	100
3	-	-	-	-	-	-	-	-	4	100
4	2	1	-	-	-	-	-	-	5	100
5	-	-	-	-	-	-	-	-	6	100
6	3	-	-	-	-	-	-	-	7	100
7	-	-	-	-	-	-	-	-	9	100
8	4	2	1	-	-	-	-	-	10	100
9	-	-	-	-	-	-	-	-	11	99
10	5	-	-	-	-	-	-	-	12	99
11	-	-	-	-	-	-	-	-	13	99
12	6	3	-	-	-	-	-	-	15	99
13	-	-	-	-	-	-	-	-	16	99
14	7	-	-	-	-	-	-	-	17	99
15	-	-	-	-	-	-	-	-	18	98
16	8	4	2	1	-	-	-	-	20	98
17	-	-	-	-	-	-	-	-	21	98
18	9	-	-	-	-	-	-	-	22	98
19	-	-	-	-	-	-	-	-	23	97
20	10	5	-	-	-	-	-	-	24	97
21	-	-	-	-	-	-	-	-	25	97
22	11	-	-	-	-	-	-	-	27	96
23	-	-	-	-	-	-	-	-	28	96
24	12	6	3	-	-	-	-	-	29	96
25	-	-	-	-	-	-	-	-	30	95
26	13	-	-	-	-	-	-	-	31	95
27	-	-	-	-	-	-	-	-	33	95
28	14	7	-	-	-	-	-	-	34	94
29	-	-	-	-	-	-	-	-	35	94
30	15	-	-	-	-	-	-	-	36	93
31	-	-	-	-	-	-	-	-	37	93
32	16	8	4	2	1	-	-	-	38	92
33	-	-	-	-	-	-	-	-	39	92
34	17	-	-	-	-	-	-	-	41	91
35	-	-	-	-	-	-	-	-	42	91
36	18	9	-	-	-	-	-	-	43	90
37	-	-	-	-	-	-	-	-	44	90
38	19	-	-	-	-	-	-	-	45	89
39	-	-	-	-	-	-	-	-	46	89
40	20	10	5	-	-	-	-	-	47	88
41	-	-	-	-	-	-	-	-	48	88
42	21	-	-	-	-	-	-	-	49	87
43	-	-	-	-	-	-	-	-	50	86
44	22	11	-	-	-	-	-	-	51	86
45	-	-	-	-	-	-	-	-	52	85
46	23	-	-	-	-	-	-	-	53	84
47	-	-	-	-	-	-	-	-	55	84
48	24	12	6	3	-	-	-	-	56	83
49	-	-	-	-	-	-	-	-	57	82
50	25	-	-	-	-	-	-	-	58	82
51	-	-	-	-	-	-	-	-	59	81
52	26	13	-	-	-	-	-	-	60	80
53	-	-	-	-	-	-	-	-	61	80
54	27	-	-	-	-	-	-	-	62	79
55	-	-	-	-	-	-	-	-	62	78
56	28	14	7	-	-	-	-	-	63	77
57	-	-	-	-	-	-	-	-	64	77
58	29	-	-	-	-	-	-	-	65	76
59	-	-	-	-	-	-	-	-	66	75
60	30	15	-	-	-	-	-	-	67	74
61	-	-	-	-	-	-	-	-	68	73
62	31	-	-	-	-	-	-	-	69	72
63	-	-	-	-	-	-	-	-	70	72
64	32	16	8	4	2	1	1	-	71	71

Table 7. CIRCULAR TRANSLATOR TABLE

Stepmode(< SM[3:0]>)									% of I <sub>max</sub>	
0000	0001	0010	0011	0100	0101	0110	0111	1111	Coil X	Coil Y
1/128	1/64	1/32	1/16	1/8	1/4	1/2	Full Step	Full Step + 1/2 rotation		
65	-	-	-	-	-	-	-	-	72	70
66	33	-	-	-	-	-	-	-	72	69
67	-	-	-	-	-	-	-	-	73	68
68	34	17	-	-	-	-	-	-	74	67
69	-	-	-	-	-	-	-	-	75	66
70	35	-	-	-	-	-	-	-	76	65
71	-	-	-	-	-	-	-	-	77	64
72	36	18	9	-	-	-	-	-	77	63
73	-	-	-	-	-	-	-	-	78	62
74	37	-	-	-	-	-	-	-	79	62
75	-	-	-	-	-	-	-	-	80	61
76	38	19	-	-	-	-	-	-	80	60
77	-	-	-	-	-	-	-	-	81	59
78	39	-	-	-	-	-	-	-	82	58
79	-	-	-	-	-	-	-	-	82	57
80	40	20	10	5	-	-	-	-	83	56
81	-	-	-	-	-	-	-	-	84	55
82	41	-	-	-	-	-	-	-	84	53
83	-	-	-	-	-	-	-	-	85	52
84	42	21	-	-	-	-	-	-	86	51
85	-	-	-	-	-	-	-	-	86	50
86	43	-	-	-	-	-	-	-	87	49
87	-	-	-	-	-	-	-	-	88	48
88	44	22	11	-	-	-	-	-	88	47
89	-	-	-	-	-	-	-	-	89	46
90	45	-	-	-	-	-	-	-	89	45
91	-	-	-	-	-	-	-	-	90	44
92	46	23	-	-	-	-	-	-	90	43
93	-	-	-	-	-	-	-	-	91	42
94	47	-	-	-	-	-	-	-	91	41
95	-	-	-	-	-	-	-	-	92	39
96	48	24	12	6	3	-	-	-	92	38
97	-	-	-	-	-	-	-	-	93	37
98	49	-	-	-	-	-	-	-	93	36
99	-	-	-	-	-	-	-	-	94	35
100	50	25	-	-	-	-	-	-	94	34
101	-	-	-	-	-	-	-	-	95	33
102	51	-	-	-	-	-	-	-	95	31
103	-	-	-	-	-	-	-	-	95	30
104	52	26	13	-	-	-	-	-	96	29
105	-	-	-	-	-	-	-	-	96	28
106	53	-	-	-	-	-	-	-	96	27
107	-	-	-	-	-	-	-	-	97	25
108	54	27	-	-	-	-	-	-	97	24
109	-	-	-	-	-	-	-	-	97	23
110	55	-	-	-	-	-	-	-	98	22
111	-	-	-	-	-	-	-	-	98	21
112	56	28	14	7	-	-	-	-	98	20
113	-	-	-	-	-	-	-	-	98	18
114	57	-	-	-	-	-	-	-	99	17
115	-	-	-	-	-	-	-	-	99	16
116	58	29	-	-	-	-	-	-	99	15
117	-	-	-	-	-	-	-	-	99	13
118	59	-	-	-	-	-	-	-	99	12
119	-	-	-	-	-	-	-	-	99	11
120	60	30	15	-	-	-	-	-	100	10
121	-	-	-	-	-	-	-	-	100	9
122	61	-	-	-	-	-	-	-	100	7
123	-	-	-	-	-	-	-	-	100	6
124	62	31	-	-	-	-	-	-	100	5
125	-	-	-	-	-	-	-	-	100	4
126	63	-	-	-	-	-	-	-	100	2
127	-	-	-	-	-	-	-	-	100	1
128	64	32	16	8	4	2	-	1	100	0
129	-	-	-	-	-	-	-	-	100	-1



Table 7. CIRCULAR TRANSLATOR TABLE

Stepmode(< SM[3:0]>)									% of I <sub>max</sub>	
0000	0001	0010	0011	0100	0101	0110	0111	1111	Coil X	Coil Y
1/128	1/64	1/32	1/16	1/8	1/4	1/2	Full Step	Full Step + 1/2 rotation		
130	65	-	-	-	-	-	-	-	100	-2
131	-	-	-	-	-	-	-	-	100	-4
132	66	33	-	-	-	-	-	-	100	-5
133	-	-	-	-	-	-	-	-	100	-6
134	67	-	-	-	-	-	-	-	100	-7
135	-	-	-	-	-	-	-	-	100	-9
136	68	34	17	-	-	-	-	-	100	-10
137	-	-	-	-	-	-	-	-	99	-11
138	69	-	-	-	-	-	-	-	99	-12
139	-	-	-	-	-	-	-	-	99	-13
140	70	35	-	-	-	-	-	-	99	-15
141	-	-	-	-	-	-	-	-	99	-16
142	71	-	-	-	-	-	-	-	99	-17
143	-	-	-	-	-	-	-	-	98	-18
144	72	36	18	9	-	-	-	-	98	-20
145	-	-	-	-	-	-	-	-	98	-21
146	73	-	-	-	-	-	-	-	98	-22
147	-	-	-	-	-	-	-	-	97	-23
148	74	37	-	-	-	-	-	-	97	-24
149	-	-	-	-	-	-	-	-	97	-25
150	75	-	-	-	-	-	-	-	96	-27
151	-	-	-	-	-	-	-	-	96	-28
152	76	38	19	-	-	-	-	-	96	-29
153	-	-	-	-	-	-	-	-	95	-30
154	77	-	-	-	-	-	-	-	95	-31
155	-	-	-	-	-	-	-	-	95	-33
156	78	39	-	-	-	-	-	-	94	-34
157	-	-	-	-	-	-	-	-	94	-35
158	79	-	-	-	-	-	-	-	93	-36
159	-	-	-	-	-	-	-	-	93	-37
160	80	40	20	10	5	-	-	-	92	-38
161	-	-	-	-	-	-	-	-	92	-39
162	81	-	-	-	-	-	-	-	91	-41
163	-	-	-	-	-	-	-	-	91	-42
164	82	41	-	-	-	-	-	-	90	-43
165	-	-	-	-	-	-	-	-	90	-44
166	83	-	-	-	-	-	-	-	89	-45
167	-	-	-	-	-	-	-	-	89	-46
168	84	42	21	-	-	-	-	-	88	-47
169	-	-	-	-	-	-	-	-	88	-48
170	85	-	-	-	-	-	-	-	87	-49
171	-	-	-	-	-	-	-	-	86	-50
172	86	43	-	-	-	-	-	-	86	-51
173	-	-	-	-	-	-	-	-	85	-52
174	87	-	-	-	-	-	-	-	84	-53
175	-	-	-	-	-	-	-	-	84	-55
176	88	44	22	11	-	-	-	-	83	-56
177	-	-	-	-	-	-	-	-	82	-57
178	89	-	-	-	-	-	-	-	82	-58
179	-	-	-	-	-	-	-	-	81	-59
180	90	45	-	-	-	-	-	-	80	-60
181	-	-	-	-	-	-	-	-	80	-61
182	91	-	-	-	-	-	-	-	79	-62
183	-	-	-	-	-	-	-	-	78	-62
184	92	46	23	-	-	-	-	-	77	-63
185	-	-	-	-	-	-	-	-	77	-64
186	93	-	-	-	-	-	-	-	76	-65
187	-	-	-	-	-	-	-	-	75	-66
188	94	47	-	-	-	-	-	-	74	-67
189	-	-	-	-	-	-	-	-	73	-68
190	95	-	-	-	-	-	-	-	72	-69
191	-	-	-	-	-	-	-	-	72	-70
192	96	48	24	12	6	3	2	-	71	-71
193	-	-	-	-	-	-	-	-	70	-72
194	97	-	-	-	-	-	-	-	69	-72

Table 7. CIRCULAR TRANSLATOR TABLE

Stepmode(< SM[3:0]>)									% of I <sub>max</sub>	
0000	0001	0010	0011	0100	0101	0110	0111	1111	Coil X	Coil Y
1/128	1/64	1/32	1/16	1/8	1/4	1/2	Full Step	Full Step + 1/2 rotation		
195	-	-	-	-	-	-	-	-	68	-73
196	98	49	-	-	-	-	-	-	67	-74
197	-	-	-	-	-	-	-	-	66	-75
198	99	-	-	-	-	-	-	-	65	-76
199	-	-	-	-	-	-	-	-	64	-77
200	100	50	25	-	-	-	-	-	63	-77
201	-	-	-	-	-	-	-	-	62	-78
202	101	-	-	-	-	-	-	-	62	-79
203	-	-	-	-	-	-	-	-	61	-80
204	102	51	-	-	-	-	-	-	60	-80
205	-	-	-	-	-	-	-	-	59	-81
206	103	-	-	-	-	-	-	-	58	-82
207	-	-	-	-	-	-	-	-	57	-82
208	104	52	26	13	-	-	-	-	56	-83
209	-	-	-	-	-	-	-	-	55	-84
210	105	-	-	-	-	-	-	-	53	-84
211	-	-	-	-	-	-	-	-	52	-85
212	106	53	-	-	-	-	-	-	51	-86
213	-	-	-	-	-	-	-	-	50	-86
214	107	-	-	-	-	-	-	-	49	-87
215	-	-	-	-	-	-	-	-	48	-88
216	108	54	27	-	-	-	-	-	47	-88
217	-	-	-	-	-	-	-	-	46	-89
218	109	-	-	-	-	-	-	-	45	-89
219	-	-	-	-	-	-	-	-	44	-90
220	110	55	-	-	-	-	-	-	43	-90
221	-	-	-	-	-	-	-	-	42	-91
222	111	-	-	-	-	-	-	-	41	-91
223	-	-	-	-	-	-	-	-	39	-92
224	112	56	28	14	7	-	-	-	38	-92
225	-	-	-	-	-	-	-	-	37	-93
226	113	-	-	-	-	-	-	-	36	-93
227	-	-	-	-	-	-	-	-	35	-94
228	114	57	-	-	-	-	-	-	34	-94
229	-	-	-	-	-	-	-	-	33	-95
230	115	-	-	-	-	-	-	-	31	-95
231	-	-	-	-	-	-	-	-	30	-95
232	116	58	29	-	-	-	-	-	29	-96
233	-	-	-	-	-	-	-	-	28	-96
234	117	-	-	-	-	-	-	-	27	-96
235	-	-	-	-	-	-	-	-	25	-97
236	118	59	-	-	-	-	-	-	24	-97
237	-	-	-	-	-	-	-	-	23	-97
238	119	-	-	-	-	-	-	-	22	-98
239	-	-	-	-	-	-	-	-	21	-98
240	120	60	30	15	-	-	-	-	20	-98
241	-	-	-	-	-	-	-	-	18	-98
242	121	-	-	-	-	-	-	-	17	-99
243	-	-	-	-	-	-	-	-	16	-99
244	122	61	-	-	-	-	-	-	15	-99
245	-	-	-	-	-	-	-	-	13	-99
246	123	-	-	-	-	-	-	-	12	-99
247	-	-	-	-	-	-	-	-	11	-99
248	124	62	31	-	-	-	-	-	10	-100
249	-	-	-	-	-	-	-	-	9	-100
250	125	-	-	-	-	-	-	-	7	-100
251	-	-	-	-	-	-	-	-	6	-100
252	126	63	-	-	-	-	-	-	5	-100
253	-	-	-	-	-	-	-	-	4	-100
254	127	-	-	-	-	-	-	-	2	-100
255	-	-	-	-	-	-	-	-	1	-100
256	128	64	32	16	8	4	-	2	0	-100
257	-	-	-	-	-	-	-	-	-1	-100
258	129	-	-	-	-	-	-	-	-2	-100
259	-	-	-	-	-	-	-	-	-4	-100

Table 7. CIRCULAR TRANSLATOR TABLE

Stepmode(< SM[3:0]>)									% of I <sub>max</sub>	
0000	0001	0010	0011	0100	0101	0110	0111	1111	Coil X	Coil Y
1/128	1/64	1/32	1/16	1/8	1/4	1/2	Full Step	Full Step + 1/2 rotation		
260	130	65	-	-	-	-	-	-	-5	-100
261	-	-	-	-	-	-	-	-	-6	-100
262	131	-	-	-	-	-	-	-	-7	-100
263	-	-	-	-	-	-	-	-	-9	-100
264	132	66	33	-	-	-	-	-	-10	-100
265	-	-	-	-	-	-	-	-	-11	-99
266	133	-	-	-	-	-	-	-	-12	-99
267	-	-	-	-	-	-	-	-	-13	-99
268	134	67	-	-	-	-	-	-	-15	-99
269	-	-	-	-	-	-	-	-	-16	-99
270	135	-	-	-	-	-	-	-	-17	-99
271	-	-	-	-	-	-	-	-	-18	-98
272	136	68	34	17	-	-	-	-	-20	-98
273	-	-	-	-	-	-	-	-	-21	-98
274	137	-	-	-	-	-	-	-	-22	-98
275	-	-	-	-	-	-	-	-	-23	-97
276	138	69	-	-	-	-	-	-	-24	-97
277	-	-	-	-	-	-	-	-	-25	-97
278	139	-	-	-	-	-	-	-	-27	-96
279	-	-	-	-	-	-	-	-	-28	-96
280	140	70	35	-	-	-	-	-	-29	-96
281	-	-	-	-	-	-	-	-	-30	-95
282	141	-	-	-	-	-	-	-	-31	-95
283	-	-	-	-	-	-	-	-	-33	-95
284	142	71	-	-	-	-	-	-	-34	-94
285	-	-	-	-	-	-	-	-	-35	-94
286	143	-	-	-	-	-	-	-	-36	-93
287	-	-	-	-	-	-	-	-	-37	-93
288	144	72	36	18	9	-	-	-	-38	-92
289	-	-	-	-	-	-	-	-	-39	-92
290	145	-	-	-	-	-	-	-	-41	-91
291	-	-	-	-	-	-	-	-	-42	-91
292	146	73	-	-	-	-	-	-	-43	-90
293	-	-	-	-	-	-	-	-	-44	-90
294	147	-	-	-	-	-	-	-	-45	-89
295	-	-	-	-	-	-	-	-	-46	-89
296	148	74	37	-	-	-	-	-	-47	-88
297	-	-	-	-	-	-	-	-	-48	-88
298	149	-	-	-	-	-	-	-	-49	-87
299	-	-	-	-	-	-	-	-	-50	-86
300	150	75	-	-	-	-	-	-	-51	-86
301	-	-	-	-	-	-	-	-	-52	-85
302	151	-	-	-	-	-	-	-	-53	-84
303	-	-	-	-	-	-	-	-	-55	-84
304	152	76	38	19	-	-	-	-	-56	-83
305	-	-	-	-	-	-	-	-	-57	-82
306	153	-	-	-	-	-	-	-	-58	-82
307	-	-	-	-	-	-	-	-	-59	-81
308	154	77	-	-	-	-	-	-	-60	-80
309	-	-	-	-	-	-	-	-	-61	-80
310	155	-	-	-	-	-	-	-	-62	-79
311	-	-	-	-	-	-	-	-	-62	-78
312	156	78	39	-	-	-	-	-	-63	-77
313	-	-	-	-	-	-	-	-	-64	-77
314	157	-	-	-	-	-	-	-	-65	-76
315	-	-	-	-	-	-	-	-	-66	-75
316	158	79	-	-	-	-	-	-	-67	-74
317	-	-	-	-	-	-	-	-	-68	-73
318	159	-	-	-	-	-	-	-	-69	-72
319	-	-	-	-	-	-	-	-	-70	-72
320	160	80	40	20	10	5	3	-	-71	-71
321	-	-	-	-	-	-	-	-	-72	-70
322	161	-	-	-	-	-	-	-	-72	-69
323	-	-	-	-	-	-	-	-	-73	-68
324	162	81	-	-	-	-	-	-	-74	-67

Table 7. CIRCULAR TRANSLATOR TABLE

Stepmode(< SM[3:0]>)									% of I <sub>max</sub>	
0000	0001	0010	0011	0100	0101	0110	0111	1111	Coil X	Coil Y
1/128	1/64	1/32	1/16	1/8	1/4	1/2	Full Step	Full Step + 1/2 rotation		
325	-	-	-	-	-	-	-	-	-75	-66
326	163	-	-	-	-	-	-	-	-76	-65
327	-	-	-	-	-	-	-	-	-77	-64
328	164	82	41	-	-	-	-	-	-77	-63
329	-	-	-	-	-	-	-	-	-78	-62
330	165	-	-	-	-	-	-	-	-79	-62
331	-	-	-	-	-	-	-	-	-80	-61
332	166	83	-	-	-	-	-	-	-80	-60
333	-	-	-	-	-	-	-	-	-81	-59
334	167	-	-	-	-	-	-	-	-82	-58
335	-	-	-	-	-	-	-	-	-82	-57
336	168	84	42	21	-	-	-	-	-83	-56
337	-	-	-	-	-	-	-	-	-84	-55
338	169	-	-	-	-	-	-	-	-84	-53
339	-	-	-	-	-	-	-	-	-85	-52
340	170	85	-	-	-	-	-	-	-86	-51
341	-	-	-	-	-	-	-	-	-86	-50
342	171	-	-	-	-	-	-	-	-87	-49
343	-	-	-	-	-	-	-	-	-88	-48
344	172	86	43	-	-	-	-	-	-88	-47
345	-	-	-	-	-	-	-	-	-89	-46
346	173	-	-	-	-	-	-	-	-89	-45
347	-	-	-	-	-	-	-	-	-90	-44
348	174	87	-	-	-	-	-	-	-90	-43
349	-	-	-	-	-	-	-	-	-91	-42
350	175	-	-	-	-	-	-	-	-91	-41
351	-	-	-	-	-	-	-	-	-92	-39
352	176	88	44	22	11	-	-	-	-92	-38
353	-	-	-	-	-	-	-	-	-93	-37
354	177	-	-	-	-	-	-	-	-93	-36
355	-	-	-	-	-	-	-	-	-94	-35
356	178	89	-	-	-	-	-	-	-94	-34
357	-	-	-	-	-	-	-	-	-95	-33
358	179	-	-	-	-	-	-	-	-95	-31
359	-	-	-	-	-	-	-	-	-95	-30
360	180	90	45	-	-	-	-	-	-96	-29
361	-	-	-	-	-	-	-	-	-96	-28
362	181	-	-	-	-	-	-	-	-96	-27
363	-	-	-	-	-	-	-	-	-97	-25
364	182	91	-	-	-	-	-	-	-97	-24
365	-	-	-	-	-	-	-	-	-97	-23
366	183	-	-	-	-	-	-	-	-98	-22
367	-	-	-	-	-	-	-	-	-98	-21
368	184	92	46	23	-	-	-	-	-98	-20
369	-	-	-	-	-	-	-	-	-98	-18
370	185	-	-	-	-	-	-	-	-99	-17
371	-	-	-	-	-	-	-	-	-99	-16
372	186	93	-	-	-	-	-	-	-99	-15
373	-	-	-	-	-	-	-	-	-99	-13
374	187	-	-	-	-	-	-	-	-99	-12
375	-	-	-	-	-	-	-	-	-99	-11
376	188	94	47	-	-	-	-	-	-100	-10
377	-	-	-	-	-	-	-	-	-100	-9
378	189	-	-	-	-	-	-	-	-100	-7
379	-	-	-	-	-	-	-	-	-100	-6
380	190	95	-	-	-	-	-	-	-100	-5
381	-	-	-	-	-	-	-	-	-100	-4
382	191	-	-	-	-	-	-	-	-100	-2
383	-	-	-	-	-	-	-	-	-100	-1
384	192	96	48	24	12	6	-	3	-100	0
385	-	-	-	-	-	-	-	-	-100	1
386	193	-	-	-	-	-	-	-	-100	2
387	-	-	-	-	-	-	-	-	-100	4
388	194	97	-	-	-	-	-	-	-100	5
389	-	-	-	-	-	-	-	-	-100	6

Table 7. CIRCULAR TRANSLATOR TABLE

Stepmode(< SM[3:0]>)									% of I <sub>max</sub>	
0000	0001	0010	0011	0100	0101	0110	0111	1111	Coil X	Coil Y
1/128	1/64	1/32	1/16	1/8	1/4	1/2	Full Step	Full Step + 1/2 rotation		
390	195	-	-	-	-	-	-	-	-100	7
391	-	-	-	-	-	-	-	-	-100	9
392	196	98	49	-	-	-	-	-	-100	10
393	-	-	-	-	-	-	-	-	-99	11
394	197	-	-	-	-	-	-	-	-99	12
395	-	-	-	-	-	-	-	-	-99	13
396	198	99	-	-	-	-	-	-	-99	15
397	-	-	-	-	-	-	-	-	-99	16
398	199	-	-	-	-	-	-	-	-99	17
399	-	-	-	-	-	-	-	-	-98	18
400	200	100	50	25	-	-	-	-	-98	20
401	-	-	-	-	-	-	-	-	-98	21
402	201	-	-	-	-	-	-	-	-98	22
403	-	-	-	-	-	-	-	-	-97	23
404	202	101	-	-	-	-	-	-	-97	24
405	-	-	-	-	-	-	-	-	-97	25
406	203	-	-	-	-	-	-	-	-96	27
407	-	-	-	-	-	-	-	-	-96	28
408	204	102	51	-	-	-	-	-	-96	29
409	-	-	-	-	-	-	-	-	-95	30
410	205	-	-	-	-	-	-	-	-95	31
411	-	-	-	-	-	-	-	-	-95	33
412	206	103	-	-	-	-	-	-	-94	34
413	-	-	-	-	-	-	-	-	-94	35
414	207	-	-	-	-	-	-	-	-93	36
415	-	-	-	-	-	-	-	-	-93	37
416	208	104	52	26	13	-	-	-	-92	38
417	-	-	-	-	-	-	-	-	-92	39
418	209	-	-	-	-	-	-	-	-91	41
419	-	-	-	-	-	-	-	-	-91	42
420	210	105	-	-	-	-	-	-	-90	43
421	-	-	-	-	-	-	-	-	-90	44
422	211	-	-	-	-	-	-	-	-89	45
423	-	-	-	-	-	-	-	-	-89	46
424	212	106	53	-	-	-	-	-	-88	47
425	-	-	-	-	-	-	-	-	-88	48
426	213	-	-	-	-	-	-	-	-87	49
427	-	-	-	-	-	-	-	-	-86	50
428	214	107	-	-	-	-	-	-	-86	51
429	-	-	-	-	-	-	-	-	-85	52
430	215	-	-	-	-	-	-	-	-84	53
431	-	-	-	-	-	-	-	-	-84	55
432	216	108	54	27	-	-	-	-	-83	56
433	-	-	-	-	-	-	-	-	-82	57
434	217	-	-	-	-	-	-	-	-82	58
435	-	-	-	-	-	-	-	-	-81	59
436	218	109	-	-	-	-	-	-	-80	60
437	-	-	-	-	-	-	-	-	-80	61
438	219	-	-	-	-	-	-	-	-79	62
439	-	-	-	-	-	-	-	-	-78	62
440	220	110	55	-	-	-	-	-	-77	63
441	-	-	-	-	-	-	-	-	-77	64
442	221	-	-	-	-	-	-	-	-76	65
443	-	-	-	-	-	-	-	-	-75	66
444	222	111	-	-	-	-	-	-	-74	67
445	-	-	-	-	-	-	-	-	-73	68
446	223	-	-	-	-	-	-	-	-72	69
447	-	-	-	-	-	-	-	-	-72	70
448	224	112	56	28	14	7	0	-	-71	71
449	-	-	-	-	-	-	-	-	-70	72
450	225	-	-	-	-	-	-	-	-69	72
451	-	-	-	-	-	-	-	-	-68	73
452	226	113	-	-	-	-	-	-	-67	74
453	-	-	-	-	-	-	-	-	-66	75
454	227	-	-	-	-	-	-	-	-65	76

Table 7. CIRCULAR TRANSLATOR TABLE

Stepmode(< SM[3:0]>)									% of I <sub>max</sub>	
0000	0001	0010	0011	0100	0101	0110	0111	1111	Coil X	Coil Y
1/128	1/64	1/32	1/16	1/8	1/4	1/2	Full Step	Full Step + 1/2 rotation		
455	-	-	-	-	-	-	-	-	-64	77
456	228	114	57	-	-	-	-	-	-63	77
457	-	-	-	-	-	-	-	-	-62	78
458	229	-	-	-	-	-	-	-	-62	79
459	-	-	-	-	-	-	-	-	-61	80
460	230	115	-	-	-	-	-	-	-60	80
461	-	-	-	-	-	-	-	-	-59	81
462	231	-	-	-	-	-	-	-	-58	82
463	-	-	-	-	-	-	-	-	-57	82
464	232	116	58	29	-	-	-	-	-56	83
465	-	-	-	-	-	-	-	-	-55	84
466	233	-	-	-	-	-	-	-	-53	84
467	-	-	-	-	-	-	-	-	-52	85
468	234	117	-	-	-	-	-	-	-51	86
469	-	-	-	-	-	-	-	-	-50	86
470	235	-	-	-	-	-	-	-	-49	87
471	-	-	-	-	-	-	-	-	-48	88
472	236	118	59	-	-	-	-	-	-47	88
473	-	-	-	-	-	-	-	-	-46	89
474	237	-	-	-	-	-	-	-	-45	89
475	-	-	-	-	-	-	-	-	-44	90
476	238	119	-	-	-	-	-	-	-43	90
477	-	-	-	-	-	-	-	-	-42	91
478	239	-	-	-	-	-	-	-	-41	91
479	-	-	-	-	-	-	-	-	-39	92
480	240	120	60	30	15	-	-	-	-38	92
481	-	-	-	-	-	-	-	-	-37	93
482	241	-	-	-	-	-	-	-	-36	93
483	-	-	-	-	-	-	-	-	-35	94
484	242	121	-	-	-	-	-	-	-34	94
485	-	-	-	-	-	-	-	-	-33	95
486	243	-	-	-	-	-	-	-	-31	95
487	-	-	-	-	-	-	-	-	-30	95
488	244	122	61	-	-	-	-	-	-29	96
489	-	-	-	-	-	-	-	-	-28	96
490	245	-	-	-	-	-	-	-	-27	96
491	-	-	-	-	-	-	-	-	-25	97
492	246	123	-	-	-	-	-	-	-24	97
493	-	-	-	-	-	-	-	-	-23	97
494	247	-	-	-	-	-	-	-	-22	98
495	-	-	-	-	-	-	-	-	-21	98
496	248	124	62	31	-	-	-	-	-20	98
497	-	-	-	-	-	-	-	-	-18	98
498	249	-	-	-	-	-	-	-	-17	99
499	-	-	-	-	-	-	-	-	-16	99
500	250	125	-	-	-	-	-	-	-15	99
501	-	-	-	-	-	-	-	-	-13	99
502	251	-	-	-	-	-	-	-	-12	99
503	-	-	-	-	-	-	-	-	-11	99
504	252	126	63	-	-	-	-	-	-10	100
505	-	-	-	-	-	-	-	-	-9	100
506	253	-	-	-	-	-	-	-	-7	100
507	-	-	-	-	-	-	-	-	-6	100
508	254	127	-	-	-	-	-	-	-5	100
509	-	-	-	-	-	-	-	-	-4	100
510	255	-	-	-	-	-	-	-	-2	100
511	-	-	-	-	-	-	-	-	-1	100

**Remarks:**

- ◆ Positive coil current conducts from MOTXP to MOTXN or MOTYP to MOTYN.

**Direction**

The direction of rotation can be changed by means of the DIR-pin and the SPI bit <DIRCTRL>. See also Figure 12 up to Figure 15. Setup and hold times need to be respected when changing direction (see Figure 6).

**NXT Input**

Every rising or falling edge on the NXT-pin (selectable through SPI bit <NXTP>) will move the coil current one step up or down (dependant on the DIR-pin and <DIRCTRL> bit) in the translator table (see Table 7). The motor current will be updated at the next PWM cycle.

**Enable**

The enable SPI bit <MOTEN> is used to enable the PWM regulator and drive coil current through the stepper motor coils. When '1' the motor driver is enabled and coil current will be conducted. If '0' (zero), the H-bridge drivers are disabled.

When the motor driver is enabled, the NXT- and DIR-pin as also the <DIRCTRL> SPI bit can be used to control the

movement of the stepper motor. It's not allowed to apply pulses on the NXT-pin when the motor driver is disabled.

Certain errors (see Error Output p28) will automatically disable the motor driver (<MOTEN> = 0). The errors first need to be cleared before one is able to enable the motor driver again.

Setup and hold times need to be respected (see Figure 6).

**Microstep Position**

To be able to track the position in the current translator table (Table 7), the microstep position SPI byte can be used (<MSP[8:0]>). This byte gives the position within the current translator table in units of 1/128 microsteps. This means that when working in 1/4<sup>th</sup> microstepping the read out microstep positions will be 0, 32, 64, ...

The microstep position can be used to track/verify the real position of the stepper motor.

Keep in mind that <MSP[8:0]> will only be update 1 μs after the NXT pulse was applied.

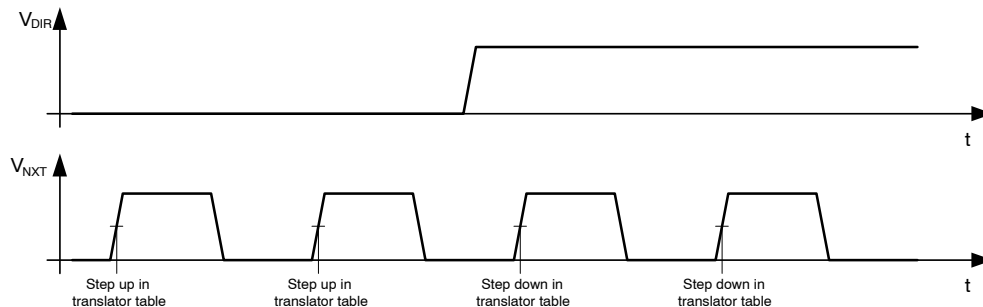
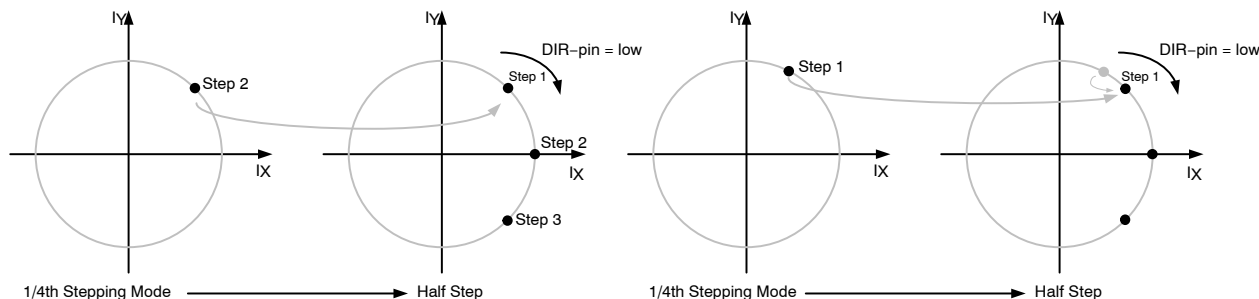

Figure 16. Translator Table Update

**Microstep**

<SM[3:0]> is used to set the microstep stepping mode. Changing to another microstep stepping mode can be done but the setup and hold timings need to be respected (see Figure 6). Changing to another stepping mode can be done in any (microstep) position. When changing to a lower

stepping mode this could lead to a change in coil current (= movement of rotor) even if no NXT pulses are applied. This will only be the case if the microstep position is not shared between the old and new stepping mode (see also Table 7 and Figure 17). This is done to avoid unwanted phase shifts in the coil current.



Step 2 of 1/4th stepping mode is equal to Step 1 of half step stepping mode (see Table 7). No change of coil current during change of stepping mode.

Step 1 of 1/4th stepping mode is NOT shared with a step in half step stepping mode (see Table 7). Change of coil current will occur during change of stepping mode (to avoid a coil current phase shift).

Figure 17. NXT-Step Mode Synchronization

**Programmable Peak-Current**

The amplitude of the current waveform in the motor coils ( $I_{max}$ ) can be programmed through SPI bits <CUR[2:0]>. The coil current can be calculated as next:

$$I_{max} = \text{<CUR[2:0]>} / R_{SENSE}$$

$R_{SENSE}$  is resistor  $R_1$  and  $R_2$  as given in Figure 9, <CUR[2:0]> is dependant on the REF-pin voltage. This makes it possible to set the coil current by means of SPI commands or by adjusting the REF-pin voltage. See also page 35.

A change in the coil current (<CUR[2:0]>) will be updated at the next PWM cycle.

**Hold Current Setting**

A second coil current value can be programmed which is called the Hold Current (<HOLD\_CUR[2:0]>). By enabling this functionality (<EN\_HOLD> = 1), AMIS-30422 will automatically change the coil current to the programmed Hold Current value when no NXT pulse is detected for a time longer than the specified <HOLD\_TIME[1:0]>. From the moment a NXT pulse is detected, AMIS-30422 will automatically set the coil current back to <CUR[2:0]>. This functionality makes it easy to add Run and Hold Current capability to your application.

The HOLDCUR-pin can be used if one wants to select Run or Hold Current manually. To use this pin, <EN\_HOLD> must be set to 0 (zero). When pulling the HOLDCUR-pin high, the coil current will be defined by the <HOLD\_CUR[2:0]> value. When pulled low, the coil current will be defined by the <CUR[2:0]> value. When <EN\_HOLD> is set to 0 (zero) <HOLD\_TIME[1:0]> will have no meaning. Switching between the two coil current values can be done at any time (= independent of the NXT frequency). By this the HOLDCUR-pin can also be used to switch between two coil current values in an easy way (even when the motor is rotating).

The Hold Current (<HOLD\_CUR[2:0]>) is calculated in the same way as the Run Current (<CUR[2:0]>).

**Clear**

Logic 0 on the CLR-pin allows normal operation of the chip. To clear the complete digital inside AMIS-30422, the CLR-pin needs to be pulled to logic 1 for a minimum time of  $t_{CLR}$  (Table 5). Clearing the motor driver can not be done during Sleep Mode. During a clear the charge pump remains active. The voltage regulator remains functional during and after the clear action and the WDb-pin is not activated.

After a clear, NXT pulses can be applied after  $t_{CLR\_SET}$  (see Figure 7).

**Speed and Load Angle Output**

The SLA-pin provides an output voltage that indicates the level of the BEMF (Back Electro Magnetic Force) voltage of the motor. This BEMF voltage is sampled during every so-called "coil current zero crossing". Per coil, two zero-current positions exist per electrical period, yielding in a total of four zero-current observation points per electrical period.

Because of the relatively high recirculation currents in the coil during current decay, the coil voltage  $V_{COIL}$  shows a transient behavior. This transient behavior (which is not the BEMF) can be made visible or invisible on the SLA-pin by means of SPI bit <SLAT>. When set to transparent (<SLAT> = '1'), the coil voltage is sampled every PWM cycle and updated on the SLA-pin (see Figure 18). When set to not-transparent (<SLAT> = '0'), only the last sample (taken right before leaving the "coil current zero crossing") will be copied to the SLA-pin (see Figure 19).

When working in not-transparent mode (<SLAT> = '0') keep in mind that there is a delay between applying the NXT pulse (to leave the "coil current zero crossing") and the updated voltage on the SLA-pin (see  $t_{SLA\_DELAY}$  in Figure 19 and Table 5).



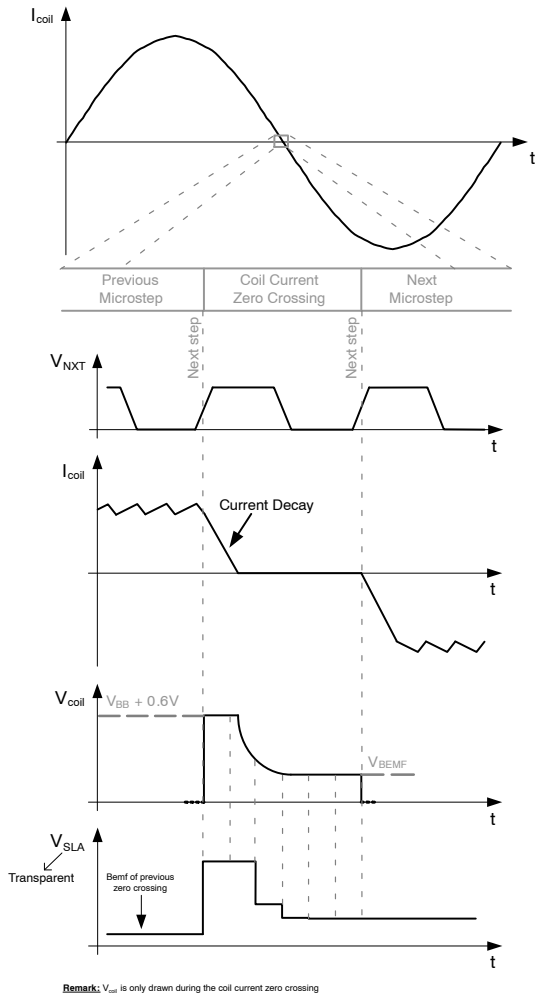

**Figure 18. Principle of BEMF Measurement in Transparent Mode**

The relationship between the voltage measured on the SLA-pin and the coil voltage is:

$$V_{SLA} = 0.6 + (0.6 \times \langle SLA\_OFFS \rangle) + (V_{coil} \times \langle SLAG \rangle)$$

SPI bit  $\langle SLA\_OFFS \rangle$  can be used to add an additional offset of 0.6 V. Five different SLA gain values can be set by means of SPI bits  $\langle SLAG[2:0] \rangle$ .

AMIS-30422 has the ability to stretch the “coil current zero crossing”. If NXT pulses are applied too fast it’s possible that the “coil current zero crossing” is too short making it impossible to measure the real BEMF (see

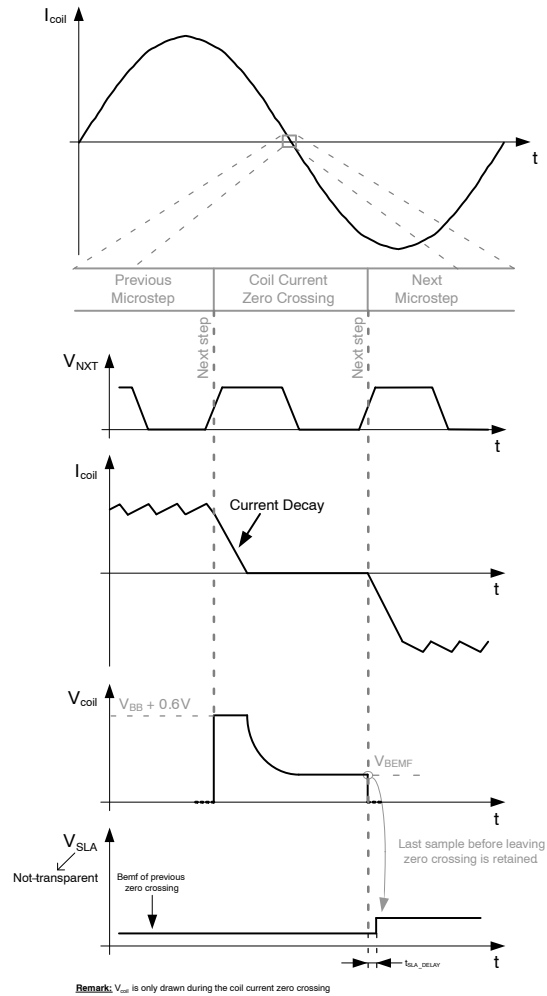

**Figure 19. Principle of BEMF Measurement in Not-Transparent Mode**

Figure 20). By using SPI bits  $\langle MIN\_SLA\_TIME[1:0] \rangle$  one can stretch the “coil current zero crossing” without changing the speed of the motor (see Figure 20). AMIS-30422 will ignore but keep track of the NXT pulses applied during the “stretched coil current zero crossing” and compensate the ignored pulses when leaving the “coil current zero crossing”.

More information on using the SLA-pin can be found in application note AND8399. Although this application note refers to AMIS-305xx, it is also valid for AMIS-30422.

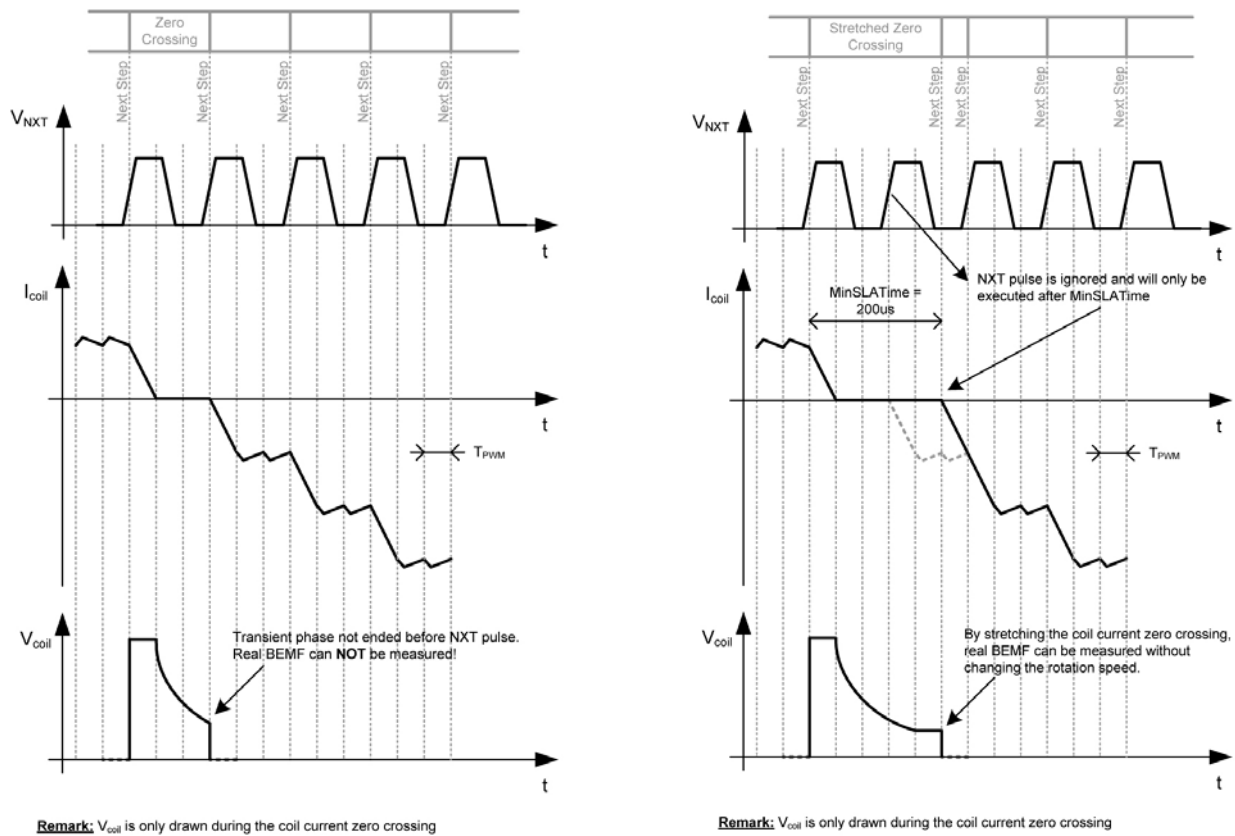

Figure 20. BEMF sampling without (left) and with (right) zero crossing stretching

**Sleep Mode**

AMIS-30422 can be placed in Sleep Mode by means of SPI bit <SLP>. This mode allows reduction of current-consumption when the motor is not in operation. The effect of sleep mode is as follows:

- The drivers are put in HiZ
- All analog circuits are disabled and in low-power mode
- All SPI registers maintain their logic content
- SPI communication is still possible (slightly current increase during SPI communication).
- Status Registers can not be cleared by reading out
- NXT and DIR inputs are forbidden
- Oscillator and digital clocks are silent
- Motor driver can not be cleared by means of the CLR-pin

The voltage regulator remains active but with reduced current-output capability ( $I_{LOAD\_PD}$ ).

When Sleep Mode is left a start-up time is needed for the charge pump to stabilize. After this time ( $t_{SLP\_SET}$ ) NXT commands can be issued (see also Figure 6). Enabling the motor when the charge pump is not stable can result in overcurrent errors (see section *Over-Current Detection*). Because of this it's advised to keep the motor disabled during the stabilization time ( $t_{SLP\_SET}$ ).

The IO-pins of AMIS-30422 have internal pull-down or pull-up resistors (see Figure 3). Keep this in mind when entering Sleep Mode.

In Sleep Mode  $V_{DD}$  can drop to 2.1 V minimum (see  $V_{DD\_SLEEP}$  in Table 4). Keep in mind that in this case it's not allowed to pull the input pins above 2.1 V!

WARNING, ERROR DETECTION AND DIAGNOSTICS FEEDBACK

**Thermal Warning and Shutdown**

AMIS-30422 has 4 thermal ranges which can be read out through SPI bits <TR[1:0]> and <TSD>. Thermal Range 1 goes from -40°C up to T<sub>1</sub>. Thermal Range 2 goes from T<sub>1</sub> to T<sub>2</sub> and Thermal Range 3 goes from T<sub>2</sub> up to T<sub>3</sub> (T<sub>1</sub>, T<sub>2</sub> and T<sub>3</sub> can be found in Table 4). Once above T<sub>3</sub> the 4<sup>th</sup> thermal level is reached which is the thermal warning range.

When junction temperature rises above T<sub>TW</sub> (= T<sub>3</sub>), the ERRb-pin will be activated. If junction temperature increases above thermal shutdown level (T<sub>TSD</sub>), then the circuit goes in Thermal Shutdown Mode and all driver transistors are disabled (high impedance). The condition to get out of the Thermal Shutdown Mode is to be at a temperature lower than T<sub>TW</sub> and by clearing the <TSD> SPI bit.

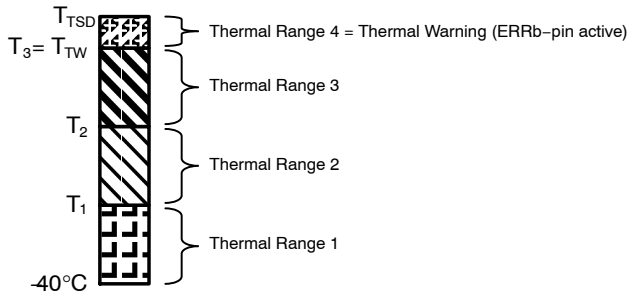

Figure 21. Thermal Ranges

**Over-Current Detection**

The over-current detection circuit monitors the load current in each activated output stage. If the load current exceeds the over-current detection threshold, the ERRb-pin will be activated and the drivers are switched off (motor driver disabled) to reduce the power dissipation and to protect the H-bridge. Each driver has an individual detection bit (see Status Register 1 and 2). The error condition is latched and the microcontroller needs to read out the error to reset the error and to be able to re-enable the motor driver again.

Note: Successive resetting the motor driver in case of a short circuit condition may damage the drivers.

**Open Coil/Current Not Reached Detection**

Open coil detection is based on the observation of 100% duty cycle of the PWM regulator. If in a coil 100% duty cycle is detected for a certain time, an open coil will be latched (see Status Register 1 and 2) and the ERRb-pin will be activated (drivers are disabled). The time this 100% duty cycle needs to be present is adjustable with SPI bits <OPEN\_COIL[1:0]>. A short time will result in fast detection of an open-coil but could also trigger unwanted open-coil errors. Increase the timing if this is the case.

When the resistance of a motor coil is very large and the supply voltage is low, it can happen that the motor driver is not able to deliver the requested current to the motor. Under these conditions the PWM controller duty cycle will be 100% and the ERRb-pin will flag this situation. This feature can be used to test if the operating conditions (supply voltage, motor coil resistance) still allow reaching the requested coil-current or else the coil current should be reduced.

Note: A short circuit could trigger an open coil.

**Charge Pump Failure**

The charge pump is an important circuit that guarantees low R<sub>DS(on)</sub> for all external MOSFET's, especially for low supply voltages. If supply voltage is too low or external components are not properly connected to guarantee a low R<sub>DS(on)</sub> of the drivers, a charge pump failure is latched (<CPFAIL>), the ERRb-pin is activated and the driver is disabled (<MOTEN> = '0'). One needs to read Status Register 1 to clear the charge pump failure.

After power on reset (POR) the charge pump voltage will need some time to exceed the required threshold. During that time the ERRb-pin will be active but not latched for 250 μs. If the slope of the power supply V<sub>BB</sub> is slow during power up (charge pump not started after 250 μs), a charge pump failure will be latched and the ERRb-pin is activated (see also Figure 22).

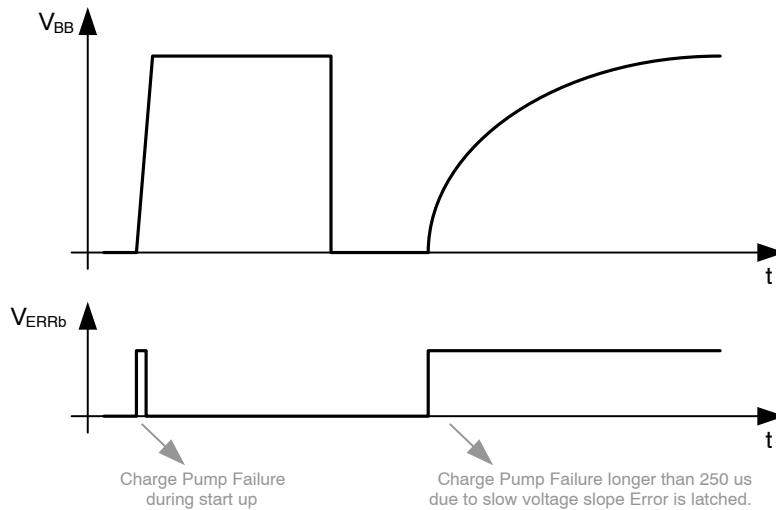

Figure 22. Charge Pump Failure

**Watchdog**

When  $V_{BB}$  is applied, the WDb-pin is kept low for  $t_{por}$  (Table 5). This can for instance be used to reset an external microcontroller at power up.

The WDb-pin also has a second function, a Watchdog function. When the watchdog is enabled ( $\langle WDEN \rangle = '1'$ ), a timer will start counting up. When the counter reaches a certain value ( $\langle WDT[3:0] \rangle$ ), the  $\langle WD \rangle$  SPI bit will be set and the WDb-pin will be pulled low for a time equal to  $t_{POR}$  to reset the external microcontroller. To avoid that the microcontroller gets reset, the microcontroller needs to re-enable the watchdog before the count value is reached (= write '1' to  $\langle WDEN \rangle$  before  $\langle WDT[3:0] \rangle$  is reached). This functionality can be used to reset a “stuck” microcontroller.

The SPI bit  $\langle WD \rangle$  can be used to detect a cold or warm boot. When powering the application (cold boot),  $\langle WD \rangle$  will be zero. If the microcontroller has been reset by the WDb-pin (warm boot),  $\langle WD \rangle$  bit will be '1'. The microcontroller can use this information to detect a cold or warm boot.

It's forbidden to re-enable the watchdog too fast (minimum time between re-enabling must be above  $t_{WDPR}$  (see Figure 4)). One may also not enable the watchdog too fast after power up (see  $t_{DSPI}$ , Figure 4).

A small analogue filter avoids resetting due to spikes or noise on the VDD supply ( $t_{rf}$ ).

During and after power up the WDb-pin is an open drain output. One can change this to a push-pull output by using SPI bit  $\langle IO\_OT \rangle$ .

**Error Output**

The error output (ERRb-pin) will be activated if an error is reported. Next errors will be reported:

- Thermal Warning
- Thermal Shutdown
- Overcurrent
- Open Coil
- Charge Pump Failure
- All errors except a Thermal Warning will disable the H-bridge drivers to protect the motor driver ( $\langle MOTEN \rangle = '0'$ ). To reset the error one needs to read out the error. Only when all errors are reset it will be possible to re-enable the motor driver ( $\langle MOTEN \rangle = '1'$ ).

Keep in mind that during power up a charge pump failure will be reported during the first 250us but will not be latched (see also *Charge Pump Failure*).

During and after power up the ERRb-pin is an open drain output. One can change this to a push-pull output with SPI bit  $\langle IO\_OT \rangle$ .

POWER SUPPLY AND THERMAL CALCULATION

**Logic Supply Regulator**

AMIS-30422 has an on-chip 3.3 V low-drop regulator to supply the digital part of the chip itself, some low-voltage analog blocks and external circuitry. See Table 4 for the limitations.

**Undervoltage**

AMIS-30422 has undervoltage detection. If  $V_{BB}$  drops below  $V_{BBUL}$ , the drivers are disabled. To be able to enable the drivers again the  $V_{BB}$  voltage needs to rise above  $V_{BBUH}$ .

See also Figure 5.

**Start-Up Behavior**

Figure 4 gives the start-up of AMIS-30422. After  $V_{BB}$  is applied and after a certain power up time ( $t_{PU}$ ), the internal voltage regulator  $V_{DD}$  will start-up. When  $V_{DD}$  gets above  $V_{DDH}$ , the internal POR will be released and the digital will start-up. The WDb-pin will be kept low for an additional 100ms ( $t_{POR}$ ). After the WDb-pin is deactivated and after a time  $t_{DSPI}$ , SPI communication can be initiated.

**Junction Temperature Calculation**

To calculate the junction temperature of AMIS-30422 the thermal resistance junction-to-ambient must be known. When only a PCB heat sink is used, a typical value is 30°C/W (see Table 4).

There are three modes the junction temperature can be calculated for.

- In Sleep Mode (<SLP> = '1') the  $V_{BAT}$  consumption is maximum 150  $\mu$ A making  $T_j = T_{amb}$ .
- In Normal Mode when the driver is disabled (<MOTEN> = '0'), the  $V_{BAT}$  consumption is maximum 20 mA (no external load on VDD-pin). The junction temperature can be calculated as next:

$$T_j = T_A + (V_{BAT} \times I_{BAT} \times R_{thJA})$$

For an 18 V application operating at an ambient temperature of 125°C this would give:

$$T_j = 125^\circ\text{C} + (18\text{ V} \times 20\text{ mA} \times 30^\circ\text{C/W})$$

$$T_j = 135.8^\circ\text{C}$$

- In Normal Mode with the driver enabled (<MOTEN> = '1') the gate charge current needs to be included in the calculations.

$$I_{BAT} = 20\text{ mA} + (6 \times V_{REGH} \times C_{ISS} \times f_{PWM})$$

For an 18 V application driving external MOSFET's with an input capacitance of 1 nF this would result in:

$$I_{BAT} = 20\text{ mA} + (6 \times 12.8\text{ V} \times 1\text{ nF} \times 30\text{ kHz})$$

$$I_{BAT} = 22.3\text{ mA}$$

Operating at 125°C ambient temperature this result in a junction temperature of:

$$T_j = 125^\circ\text{C} + (18\text{ V} \times 22.3\text{ mA} \times 30^\circ\text{C/W})$$

$$T_j = 137^\circ\text{C}$$

SPI INTERFACE

The serial peripheral interface (SPI) allows an external microcontroller (Master) to communicate with AMIS-30422. The implemented SPI block is designed to interface directly with numerous microcontrollers from several manufacturers. AMIS-30422 acts always as a Slave and can't initiate any transmission. The operation of the device is configured and controlled by means of SPI registers which are observable for read and/or write from the Master.

SPI Transfer Format and Pin Signals

During a SPI transfer, data is simultaneously transmitted (shifted out serially) and received (shifted in serially). A serial clock line (CLK) synchronizes shifting and sampling of the information on the two serial data lines (DO and DI).

DO signal is the output from the Slave (AMIS-30422), and DI signal is the output from the Master. A chip select line (CSb) allows individual selection of a Slave SPI device in a multiple-slave system. The CSb line is active low. If AMIS-30422 is not selected, DO is in HiZ and does not interfere with SPI bus activity. The output type of DO can be set in SPI (<IO\_OT>). Since AMIS-30422 operates as a Slave in MODE 0 (CPOL = 0; CPHA = 0) it always clocks data out on the falling edge and samples data in on rising edge of clock. The Master SPI port must be configured in MODE 0 too, to match this operation.

The diagram below is both a Master and a Slave timing diagram since CLK, DO and DI pins are directly connected between the Master and the Slave.

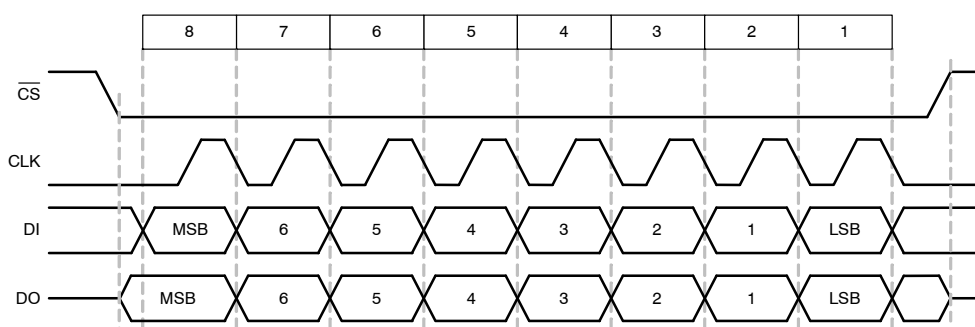

Figure 23. Timing Diagram of a SPI Transfer

Transfer Packet

Serial data transfer is assumed to follow MSB first rule. The transfer packet contains one or more bytes.

Byte 1 contains the Command and the SPI Register Address and indicates to AMIS-30422 the chosen type of operation and addressed register. Byte 2 contains data, or sent from the Master in a WRITE operation, or received from AMIS-30422 in a READ operation.

Two command types can be distinguished in the communication between master and AMIS-30422:

- CMD2 = '0': READ from SPI Register with address ADDR[4:0]
- CMD2 = '1': WRITE to SPI Register with address ADDR[4:0]

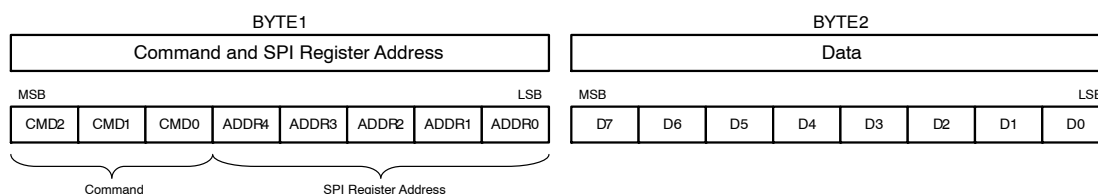

Figure 24. SPI Transfer Packet

READ Operation

If the Master wants to read data from a Status or Control Register, it initiates the communication by sending a READ command. This READ command contains the address of the SPI register to be read out. At the falling edge of the eight clock pulse the data-out shift register is updated with the content of the corresponding internal SPI register. In the next 8-bit clock pulse train this data is shifted out via DO pin. At

the same time the data shifted in from DI (Master) should be interpreted as the following successive command or dummy data.

Status Register 0, 1 and 2 (see SPI Registers) contain 7 data bits and a parity check bit. The most significant bit (D7) represents a parity of D[6:0]. If the number of logical ones in D[6:0] is odd, the parity bit D7 equals '1'. If the number of logical ones in D[6:0] is even then the parity bit D7 equals

'0'. This simple mechanism protects against noise and increases the consistency of the transmitted data. If a parity check error occurs it is recommended to initiate an additional READ command to obtain the status again.

The CSb-pin is active low and may remain low between successive READ commands as illustrated in Figure 27. There is one exception. In case an error condition occurs the

root cause of the problem can be determined by reading out the Status Registers. However, if the error occurs at the moment CSb is low, one first needs to pull CSb high to update the Status Registers properly. Only then the Status Registers can be read out to determine the error. For this reason it is also recommended to keep CSb high when the SPI bus is idle.

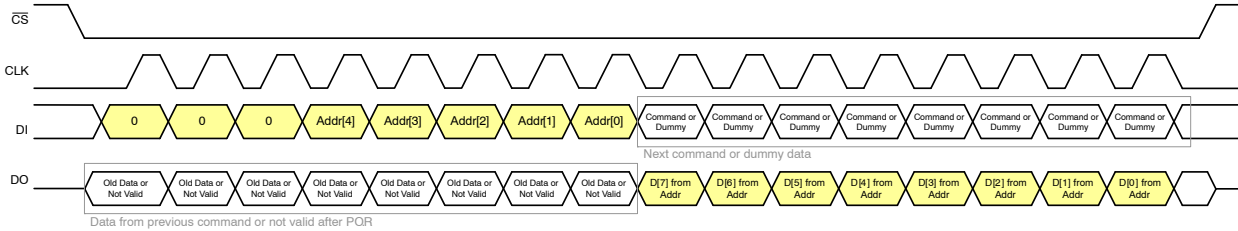

Figure 25. Single READ Operation Where Data from SPI Register is Read by the Master

**WRITE Operation**

If the Master wants to write data to a Control Register it initiates the communication by sending a WRITE command. This contains the address of the SPI register to write to. The command is followed with a data byte. This incoming data will be stored in the corresponding Control Register after CSb goes from low to high. It is important that the writing action to the Control Register is exactly 16 bits long and that CSb goes high after these 16 bits. If more or

less bits are transmitted the complete transfer packet is ignored.

A WRITE command executed for a read-only register (e.g. Status Registers) will not affect the addressed register and the device operation.

AMIS-30422 responds on every incoming byte by shifting out via DO the data stored in the last received address. Because after a power-on-reset the initial address is unknown the data shifted out via DO is not valid.

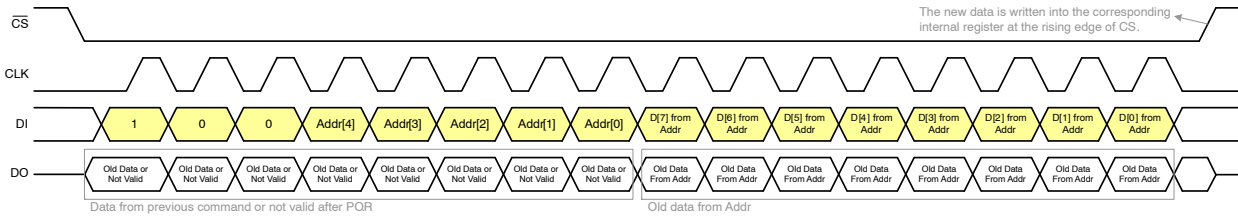

Figure 26. Single WRITE Operation Where Data from the Master is Written in SPI Register

**Examples of READ and WRITE Operations**

In the following examples successive READ and/or WRITE operations are combined. In Figure 27 the Master first reads the status from Register at Addr1 and at Addr2

followed by writing a control byte in Control Register at Addr3. Note that during the WRITE command the old data of the pointed register is returned at the moment the new data is shifted in.

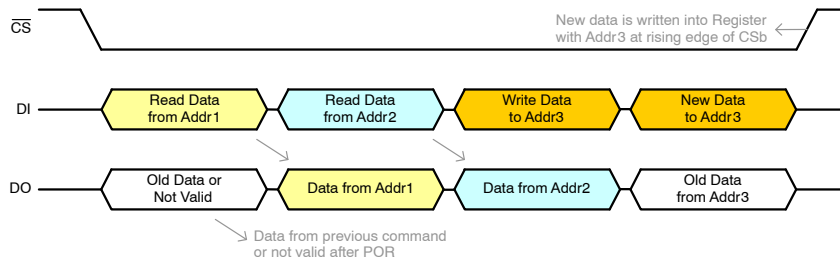

Figure 27. 2 Successive READ Commands Followed by a WRITE Command

After a WRITE operation the Master could initiate a READ command in order to verify the data correctly written as illustrated in Figure 28. During reception of the READ command the old data is returned for a second time. Only after receiving the READ command the new data is

transmitted. This rule also applies when the master device wants to initiate an SPI transfer to read the Status Registers. Because the internal system clock updates the Status Registers only when CSb line is high, the first read out byte might represent old status information (Figure 29).

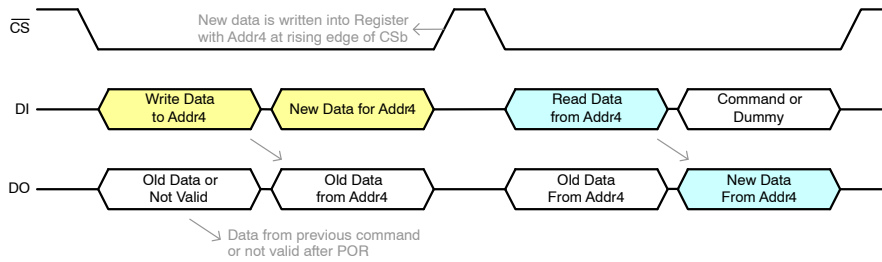

Figure 28. WRITE Operation Followed by a READ operation to verify

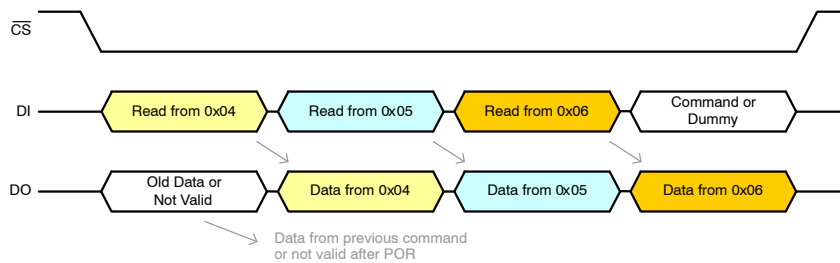

Figure 29. 3 READ Operations in a Row

**Bad Examples of READ and WRITE Operations**

The following example demonstrates a bad WRITE operation. After a WRITE operation a read operation is done before CSb is made high. The data will not be written in the Register. Figure 31 demonstrates how it should be done (see also Figure 28).

The second example (Figure 32) demonstrates an incorrect way of reading errors. After a WRITE operation the ERRb-pin toggles indication an error. Without toggling CSb the 3 Status Registers are read out to determine the error. Because CSb was not high after the error was detected, the Status Registers will not be updated and the error can not

be determined. A second problem with Figure 32 is that the data written to Addr9 will not be stored because CSb was not toggled after the write operation.

Figure 34 gives the correct way of reading out errors. When the error is detected (toggling of ERRb-pin), CSb is made high to make sure the Status Registers are updated. Then the Status Registers are read out. Notice that ERRb toggles after Status Register 1 is read out (Addr 0x05). This indicates that the error was an overcurrent in the X-coil, a charge pump failure or an open X-coil. Also notice that because CSb is made high after the write operation, the write operation will now be done correctly.

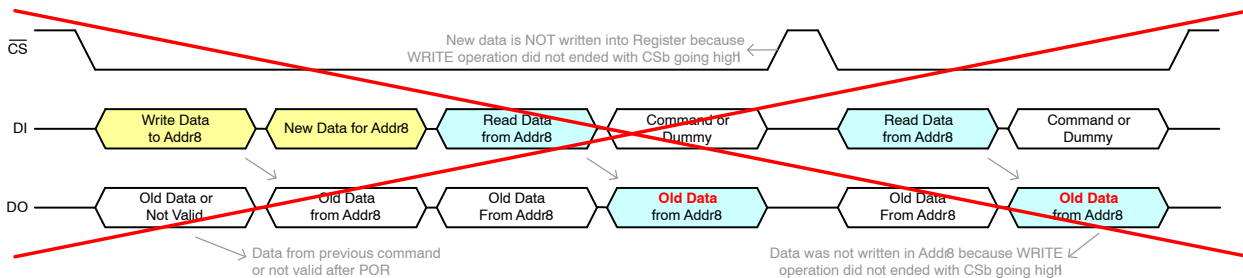
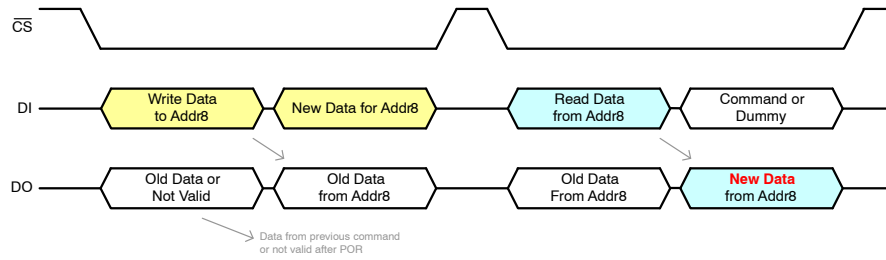

Figure 30. Bad Example of Write Operation



# AMIS-30422



**Figure 31. Good Write Operation**

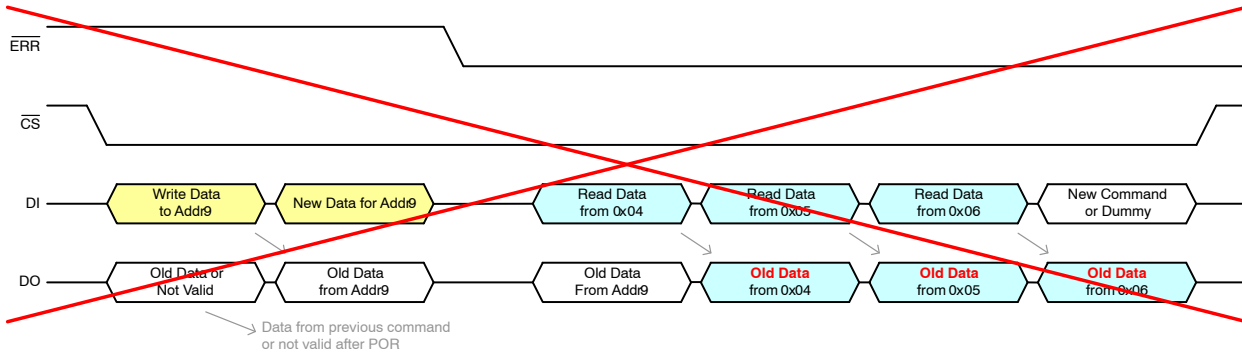

**Figure 32. Bad Example of Error Read Out**

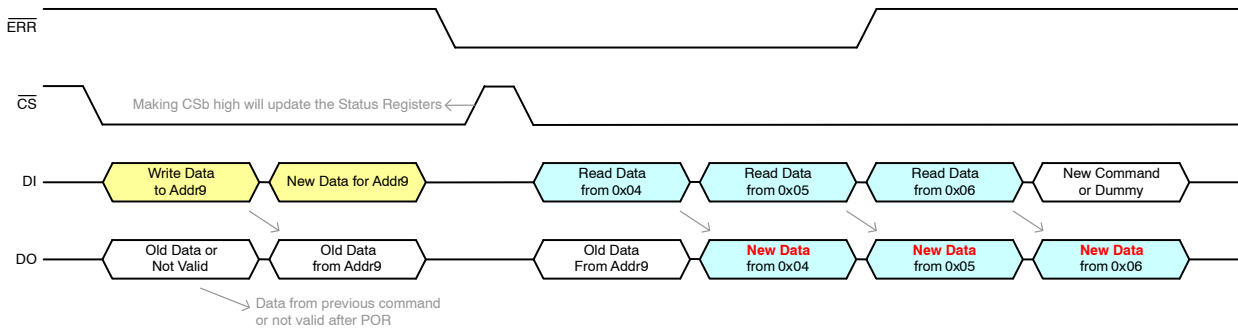

**Figure 33. Correct Read Out of Error**

## SPI Register Description

Below table gives an overview of all SPI Registers that can be used.

**Table 8. SPI REGISTER OVERVIEW**

SPI Register	Address	Access	Abbreviation
Watchdog Register	0x00	R/W	WR
Control Register 0	0x01	R/W	CR0
Control Register 1	0x02	R/W	CR1
Control Register 2	0x03	R/W	CR2
Control Register 3	0x04	R/W	CR3
Status Register 0	0x05	R	SR0
Status Register 1	0x06	R	SR1
Status Register 2	0x07	R	SR2
Status Register 3	0x08	R	SR3

**Table 8. SPI REGISTER OVERVIEW**

SPI Register	Address	Access	Abbreviation
Status Register 4	0x09	R	SR4
Predriver Register 0	0x0A	R/W	PDRV0
Predriver Register 1	0x0B	R/W	PDRV1
Predriver Register 2	0x0C	R/W	PDRV2
Predriver Register 3	0x0D	R/W	PDRV3

Where: R/W = read and write access, R = read access only

**Watchdog Register (WR)**

The Watchdog Register is located at address 0x00 and can be used to enable the watchdog and set the watchdog time-out. It can also be used to set the short circuit and open coil detection time-out.

**Table 9. WATCHDOG REGISTER**

Watchdog Register (WR)									
Address		Bit 7	Bit 6	Bit 5	Bit 4	Bit 3	Bit 2	Bit 1	Bit 0
0x00	Access	R/W	R/W	R/W	R/W	R/W	R/W	R/W	R/W
	Reset	0	0	0	0	0	1	0	0
	Data	WDEN	WDT[3:0]				OPEN_COIL[1:0]		-

**Table 10. WATCHDOG REGISTER PARAMETERS**

Parameter	Value	Value	Description	Info
WDEN	0	Disable	Enables the watchdog	p28
	1	Enable		
WDT[3:0]	0000	32 ms	Defines the watchdog time-out period. The watchdog needs to be re-enabled (WDEN) within this time or WDb-pin is activated for tPOR.	p28
	0001	64 ms		
	0010	96 ms		
	0011	128 ms		
	0100	160 ms		
	0101	192 ms		
	0110	224 ms		
	0111	256 ms		
	1000	288 ms		
	1001	320 ms		
	1010	352 ms		
	1011	384 ms		
OPEN_COIL[1:0]	00	2.56 ms	Defines the open coil detection time-out. If an open coil is detected for a time longer than OpenTimeOut[1:0], an open coil (OPEN_X and/or OPEN_Y) will be reported. Note: Short circuit could trigger open coil detection.	p27
	01	0.32 ms		
	10	20.48 ms		
	11	163.84 ms		

Remark: Bit 0 of Watchdog Register should always be '0' (zero)!

**Control Register 0 (CR0)**

Control Register 0 is located at address 0x01 and is used to set the maximum coil current and stepping mode.

**Table 11. CONTROL REGISTER 0**

Control Register 0 (CR0)									
Address		Bit 7	Bit 6	Bit 5	Bit 4	Bit 3	Bit 2	Bit 1	Bit 0
0x01	Access	R/W	R/W	R/W	R/W	R/W	R/W	R/W	R/W
	Reset	0	0	0	0	0	1	1	1
	Data	SM[3:0]				-	CUR[2:0]		

**Table 12. CONTROL REGISTER 0 PARAMETERS**

Parameter	Value	Value	Description	Info
SM[3:0]	0000	128 <sup>th</sup>	Defines the 8 stepping modes for the PWM regulator.	p23
	0001	64 <sup>th</sup>		
	0010	32 <sup>nd</sup>		
	0011	16 <sup>th</sup>		
	0100	8 <sup>th</sup>		
	0101	4 <sup>th</sup>		
	0110	Half step		
	0111	Full Step		
	1111	Full Step + 1/2 rotation		
	Other	Reserved		
CUR[2:0]	000	$V_{REF} / 40$	Defines the maximum voltage over the coil current sense resistor which defines the maximum coil current. The maximum coil current is calculated as next: $I_{coil} = CUR[2:0] / R_{sense}$ $V_{REF}$ = voltage on REF-pin (with a maximum of 2 V)	p24
	001	$V_{REF} / 20$		
	010	$3 \times V_{REF} / 40$		
	011	$V_{REF} / 10$		
	100	$V_{REF} / 8$		
	101	$3 \times V_{REF} / 20$		
	110	$7 \times V_{REF} / 40$		
	111	$V_{REF} / 5$		

**Control Register 1 (CR1)**

Control Register 1 is located at address 0x02 and can be used to set the direction, NXT-pin polarity, output configuration of WDb- and ERRb- pin and to enable PWM jitter. It can also be used to set the coil current zero-crossing.

**Table 13. CONTROL REGISTER 1**

Control Register 1 (CR1)									
Address		Bit 7	Bit 6	Bit 5	Bit 4	Bit 3	Bit 2	Bit 1	Bit 0
0x02	Access	R/W	R/W	R/W	R/W	R/W	R/W	R/W	R/W
	Reset	0	0	0	1	1	0	0	0
	Data	DIRCTRL	NXTP	-	WDb_OD	ERRb_OD	PWMJ	MINSLATIME[1:0]	

**Table 14. CONTROL REGISTER 1 PARAMETERS**

Parameter	Value	Value	Description	Info
DIRCTRL	0	CW	Defines the direction of rotation. <u>Remark:</u> CW and CCW is relative. Direction of rotation will be defined by the status of the DIR-pin and connection of the stepper motor!	p23
	1	CCW		
NXTP	0	Positive Edge	Defines the active edge on the NXT-pin.	p23
	1	Negative Edge		
WDb_OD	0	Push Pull	Defines the output type of WDb-pin	p28
	1	Open Drain		
ERRb_OD	0	Push Pull	Defines the output type of ERRb-pin	p28
	1	Open Drain		
PWMJ	0	Disabled	Enables or disables PWM jitter	p14
	1	Enabled		
MINSLATIME[1:0]	00	40 $\mu$ s	Defines the time coil current zero-crossing extension time.	p21
	01	120 $\mu$ s		
	10	200 $\mu$ s		
	11	360 $\mu$ s		

Remark: Bit 5 of Control Register 1 should always be '0' (zero)!

**Control Register 2 (CR2)**

Control Register 2 is located at address 0x03 and can be used to enable the motor driver and to put the motor driver in sleep mode. It also has some parameters that can be used to set the SLA.

**Table 15. CONTROL REGISTER 2**

Control Register 2 (CR2)									
Address		Bit 7	Bit 6	Bit 5	Bit 4	Bit 3	Bit 2	Bit 1	Bit 0
0x03	Access	R/W	R/W	R/W	R/W	R/W	R/W	R/W	R/W
	Reset	0	0	0	0	0	0	0	0
	Data	MOTEN	SLP	-	SLAT	SLAG[2:0]			SLA_OFFS

**Table 16. CONTROL REGISTER 2 PARAMETERS**

Parameter	Value	Value	Description	Info
MOTEN	0	Disabled	Enables the PWM regulator. <u>Remark:</u> the regulator is automatically disabled if one of the bits in Status Register 1 or 2 is set.	p23
	1	Enabled		
SLP	0	Normal Mode	Enables the sleep mode (power down mode)	p26
	1	Sleep Mode		
SLAT	0	Not Transparent	Defines the type of SLA sampling.	p24
	1	Transparent		

**Table 16. CONTROL REGISTER 2 PARAMETERS**

Parameter	Value	Value	Description	Info
SLAG[2:0]	000	1	Defines the motor terminal voltage division factor for the SLA-pin.	p24
	001	0.5		
	010	0.25		
	011	0.125		
	100	0.0625		
	101	0.0625		
	110	0.0625		
	111	0.0625		
SLA_OFFS	0	No additional offset	To enable an additional offset on the SLA-pin of 0.6V.	p24
	1	Additional offset of 0.6 V		

Remark: Bit 5 of Control Register 2 should always be '0' (zero)!

**Control Register 3 (CR3)**

Control Register 3 is located at address 0x04 and is used to set the hold coil current functionality.

**Table 17. CONTROL REGISTER 3**

Control Register 3 (CR3)									
Address		Bit 7	Bit 6	Bit 5	Bit 4	Bit 3	Bit 2	Bit 1	Bit 0
0x04	Access	R/W	R/W	R/W	R/W	R/W	R/W	R/W	R/W
	Reset	1	0	1	0	0	1	1	1
	Data	EN_HOLD	-	HOLD_TIME[1:0]		-	HOLD_CUR[2:0]		

**Table 18. CONTROL REGISTER 3 PARAMETERS**

Parameter	Value	Value	Description	Info
EN_HOLD	0	Disable	Enable or disable the automatic switching from CUR[2:0] to HOLD_CUR[2:0]	p24
	1	Enable		
HOLD_TIME[1:0]	00	128 ms	If EN_HOLD is set to 1 and no NXT pulses are detected for a time minimum to the HOLD_TIME[1:0], coil current will be set to HOLD_CUR[2:0]	p24
	01	256 ms		
	10	512 ms		
	11	1024 ms		
HOLD_CUR[2:0]	000	$V_{REF} / 40$	Defines the maximum voltage over the coil current sense resistor which defines the maximum coil current. The maximum coil current is calculated as next: $I_{coil} = HOLD\_CUR[2:0] / R_{sense}$ $V_{REF}$ = voltage on REF-pin (with a maximum of 2 V)	p24
	001	$V_{REF} / 20$		
	010	$3 \times V_{REF} / 40$		
	011	$V_{REF} / 10$		
	100	$V_{REF} / 8$		
	101	$3 \times V_{REF} / 20$		
	110	$7 \times V_{REF} / 40$		
	111	$V_{REF} / 5$		

Remark: Bit 3 and 6 should always be '0'+ (zero)!

**Status Register 0 (SR0)**

Status Register 0 is located at address 0x05 and can only be read. Status Register 0 is a non-latched register meaning that the value of the register can change without the need of reading out the register. The register can be used to retrieve the temperature range or to verify a watchdog event.

Notice that bit 7 is the parity bit (see READ operation p30).

**Table 19. STATUS REGISTER 0**

Status Register 0 (SR0)									
Address		Bit 7	Bit 6	Bit 5	Bit 4	Bit 3	Bit 2	Bit 1	Bit 0
0x05	Access	R	R	R	R	R	R	R	R
	Reset	0	0	0	0	0	1	0	0
	Data	PAR	TR[1:0]		WD	-	-	-	-

**Table 20. STATUS REGISTER 0 PARAMETERS**

Parameter	Value	Value	Description	Info
TR[1:0]	00	-40°C to 15°C	Motor driver thermal range. Remark: TR[1:0] = 11 and TSD = 0 => Thermal Warning TR[1:0] = 11 and TSD = 1 => Thermal Shutdown TSD is located in Status Register 2	p27
	01	15°C to 72°C		
	10	73°C to 150°C		
	11	TSD = 0: 150°C to 170°C TSD = 1: >170°C		
WD	0	No watchdog event	If WDEN = 1 and watchdog not acknowledged before the Watchdog Time-out (WDT[3:0]), WDb-pin will be pulled low for 100ms to reset an external microcontroller and WD bit will be set to '1' to indicate this event. The external microcontroller can use this bit to verify a cold (WD = 0) or warm boot (WD = 1).	p28
	1	Watchdog event occurred		

**Status Register 1 (SR1)**

Status Register 1 is located at address 0x06 and can only be read. Status Register 1 is a latched register. If an error occurs the bit will be set and can only be cleared by reading out this bit<sup>1</sup>. The register is used to report an overcurrent or open coil in the X-coil, or to report a charge pump failure.

Notice that bit 7 is the parity bit (see READ operation p30).

**Table 21. STATUS REGISTER 1**

Status Register 1 (SR1)									
Address		Bit 7	Bit 6	Bit 5	Bit 4	Bit 3	Bit 2	Bit 1	Bit 0
0x06	Access	R	R	R	R	R	R	R	R
	Reset	0	0	0	0	0	0	0	0
	Data	PAR	OVCXPT	OVCXPB	OVCXNT	OVCXNB	CPFAIL	OPEN_X	-

1. In Sleep mode the register can be read out but will not be cleared!

**Table 22. STATUS REGISTER 1 PARAMETERS**

Parameter	Value	Value	Description	Info
OVCXPT	0	No overcurrent	Overcurrent detection in top transistor XP-terminal	p27
	1	Overcurrent		
OVCXPB	0	No overcurrent	Overcurrent detection in bottom transistor XP-terminal	p27
	1	Overcurrent		
OVCXNT	0	No overcurrent	Overcurrent detection in top transistor XN-terminal	p27
	1	Overcurrent		
OVCXNB	0	No overcurrent	Overcurrent detection in bottom transistor XN-terminal	p27
	1	Overcurrent		
CPFAIL	0	No charge pump failure	Charge pump failure detection	p27
	1	Charge pump failure		
OPEN_X	0	No open coil detected	Open coil detection for X-coil Note: a short circuit could trigger an open coil	p27
	1	Open coil detected		

**Status Register 2 (SR2)**

Status Register 2 is located at address 0x07 and can only be read. Status Register 2 is a latched register. If an error occurs the bit will be set and can only be cleared by reading out this bit<sup>2</sup>. The register is used to report an overcurrent or open coil in the Y-coil, or to report a thermal shutdown.

Notice that bit 7 is the parity bit (see READ operation p30).

**Table 23. STATUS REGISTER 2**

Status Register 2 (SR2)									
Address		Bit 7	Bit 6	Bit 5	Bit 4	Bit 3	Bit 2	Bit 1	Bit 0
0x07	Access	R	R	R	R	R	R	R	R
	Reset	0	0	0	0	0	0	0	0
	Data	PAR	OVCYPT	OVCYPB	OVCYNT	OVCYNB	TSD	OPEN_Y	-

**Table 24. STATUS REGISTER 2 PARAMETERS**

Parameter	Value	Value	Description	Info
OVCYPT	0	No overcurrent	Overcurrent detection in top transistor YP-terminal	p27
	1	Overcurrent		
OVCYPB	0	No overcurrent	Overcurrent detection in bottom transistor YP-terminal	p27
	1	Overcurrent		
OVCYNT	0	No overcurrent	Overcurrent detection in top transistor YN-terminal	p27
	1	Overcurrent		
OVCYNB	0	No overcurrent	Overcurrent detection in bottom transistor YN-terminal	p27
	1	Overcurrent		
TSD	0	No thermal shutdown	Thermal Shutdown detection	p27
	1	Thermal shutdown		
OPEN_Y	0	No open coil detected	Open coil detection for X-coil Note: a short circuit could trigger an open coil	p27
	1	Open coil detected		

2. In Sleep mode the register can be read out but will not be cleared!

**Status Register 3 (SR3)**

Status Register 3 is located at address 0x08 and can only be read. Status Register 3 contains the highest 8 bits of the microstepping position and can be used to retrieve the position in the translator table (see Table 7). It is a non-latched register meaning that the microstepping position can be updated by the motor driver at any moment. Status Register 3 does not contain a parity bit.

**Table 25. STATUS REGISTER 3**

Status Register 3 (SR3)									
Address		Bit 7	Bit 6	Bit 5	Bit 4	Bit 3	Bit 2	Bit 1	Bit 0
0x08	Access	R	R	R	R	R	R	R	R
	Reset	0	0	0	0	0	0	0	0
	Data	MSP[8:1]							

**Table 26. STATUS REGISTER 3 PARAMETERS**

Parameter	Value	Value	Description	Info
MSP[8:1]	xxxx xxxx	Microstepping position	Indicates the position within the translator table	p23

**Status Register 4 (SR4)**

Status Register 4 is located at address 0x09 and can only be read. Status Register 4 contains the lowest 8 bits of the microstepping position and can be used to retrieve the position in the translator table (see Table 7). It is a non-latched register meaning that the microstepping position can be updated by the motor driver at any moment. Status Register 4 does not contain a parity bit.

**Table 27. STATUS REGISTER 4**

Status Register 4 (SR4)									
Address		Bit 7	Bit 6	Bit 5	Bit 4	Bit 3	Bit 2	Bit 1	Bit 0
0x09	Access	R	R	R	R	R	R	R	R
	Reset	0	0	0	0	0	0	0	0
	Data	MSP[7:0]							

**Table 28. STATUS REGISTER 4 PARAMETERS**

Parameter	Value	Value	Description	Info
MSP[7:0]	xxxx xxxx	Microstepping position	Indicates the position within the translator table	p23



**Predriver Register 0 (PDRV0)**

Predriver Register 0 is located at address 0x0A and can be used to set the current source for the gate charge and discharge (see Figure 11).

**Table 29. PREDRIVER REGISTER 0**

Predriver Register 0 (PDRV0)									
Address		Bit 7	Bit 6	Bit 5	Bit 4	Bit 3	Bit 2	Bit 1	Bit 0
0x0A	Access	R/W	R/W	R/W	R/W	R/W	R/W	R/W	R/W
	Reset	1	1	1	1	1	1	1	1
	Data	ION[3:0]				IOFF[3:0]			

**Table 30. PREDRIVER REGISTER 0 PARAMETERS**

Parameter	Value	Value	Description	Info
ION[3:0]	xxxx	Current source value	Defines the current source for charging and discharging of the external MOSFET's. Current source can be calculated as next: 3 mA + (ION[3:0] x 2 mA) and 3 mA + (IOFF[3:0] x 2 mA)	p13
IOFF[3:0]	xxxx			

**Predriver Register 1 (PDRV1)**

Predriver Register 1 is located at address 0x0B and can be used to set the non-overlap time as well as  $t_2$  (see Figure 11).

**Table 31. PREDRIVER REGISTER 1**

Predriver Register 1 (PDRV1)									
Address		Bit 7	Bit 6	Bit 5	Bit 4	Bit 3	Bit 2	Bit 1	Bit 0
0x0B	Access	R/W	R/W	R/W	R/W	R/W	R/W	R/W	R/W
	Reset	0	1	0	0	0	0	0	0
	Data	NO_CROSS[1:0]		TOP_t2[2:0]			BOT_t2[2:0]		

**Table 32. PREDRIVER REGISTER 1 PARAMETERS**

Parameter	Value	Value	Description	Info
NO_CROSS[2:0]	00	0	Defines time between switching off one transistor and switching on the next.	p13
	01	40 $\mu$ s		
	10	80 $\mu$ s		
	11	160 $\mu$ s		
TOP_t2[2:0]	000	1.25 $\mu$ s	Defines the switch on duration $t_2$ for the external top MOSFET's.	p13
	001	1.75 $\mu$ s		
	010	2.25 $\mu$ s		
	011	2.75 $\mu$ s		
	100	3.25 $\mu$ s		
	101	3.75 $\mu$ s		
	110	4.25 $\mu$ s		
	111	4.75 $\mu$ s		

**Table 32. PREDRIVER REGISTER 1 PARAMETERS**

Parameter	Value	Value	Description	Info
BOT_t2[2 :0]	000	1.25 $\mu$ s	Defines the switch on duration $t_2$ for the external bottom MOSFET's.	p13
	001	1.75 $\mu$ s		
	010	2.25 $\mu$ s		
	011	2.75 $\mu$ s		
	100	3.25 $\mu$ s		
	101	3.75 $\mu$ s		
	110	4.25 $\mu$ s		
	111	4.75 $\mu$ s		

**Predriver Register 2 (PDRV2)**

Predriver Register 2 is located at address 0x0C and can be used to set  $t_{off}$  (see Figure 11).

**Table 33. PREDRIVER REGISTER 2**

Predriver Register 2 (PDRV2)									
Address		Bit 7	Bit 6	Bit 5	Bit 4	Bit 3	Bit 2	Bit 1	Bit 0
0x0C	Access	R/W	R/W	R/W	R/W	R/W	R/W	R/W	R/W
	Reset	0	0	0	1	0	0	0	1
	Data	-	TOP_toff[2:0]			-	BOT_toff[2:0]		

**Table 34. PREDRIVER REGISTER 2 PARAMETERS**

Parameter	Value	Value	Description	Info
TOP_toff[2:0]	000	1.25 $\mu$ s	Defines the switch off duration $t_{off}$ for the external top MOSFET's.	p13
	001	1.75 $\mu$ s		
	010	2.25 $\mu$ s		
	011	2.75 $\mu$ s		
	100	3.25 $\mu$ s		
	101	3.75 $\mu$ s		
	110	4.25 $\mu$ s		
	111	4.75 $\mu$ s		
BOT_toff[2 :0]	000	1.25 $\mu$ s	Defines the switch off duration $t_{off}$ for the external bottom MOSFET's.	p13
	001	1.75 $\mu$ s		
	010	2.25 $\mu$ s		
	011	2.75 $\mu$ s		
	100	3.25 $\mu$ s		
	101	3.75 $\mu$ s		
	110	4.25 $\mu$ s		
	111	4.75 $\mu$ s		

**Predriver Register 3 (PDRV3)**

Predriver Register 3 is located at address 0x0D and can be used to set  $t_1$  (see Figure 11).

**Table 35. PREDRIVER REGISTER 3**

Predriver Register 3 (PDRV3)									
Address		Bit 7	Bit 6	Bit 5	Bit 4	Bit 3	Bit 2	Bit 1	Bit 0
0x0D	Access	R/W	R/W	R/W	R/W	R/W	R/W	R/W	R/W
	Reset	0	0	0	1	0	0	0	1
	Data	-	TOP_t1[2:0]			-	BOT_t1[2:0]		

**Table 36. PREDRIVER REGISTER 3 PARAMETERS**

Parameter	Value	Value	Description	Info
TOP_t1[2:0]	000	375 ns	Defines the switch on duration $t_1$ for the external top MOSFET's.	p13
	001	500 ns		
	010	625 ns		
	011	750 ns		
	100	825 ns		
	101	1000 ns		
	110	1125 ns		
	111	1250 ns		
BOT_t1[2:0]	000	375 ns	Defines the switch on duration $t_1$ for the external bottom MOSFET's.	p13
	001	500 ns		
	010	625 ns		
	011	750 ns		
	100	825 ns		
	101	1000 ns		
	110	1125 ns		
	111	1250 ns		

PACKAGE THERMAL CHARACTERISTICS

The AMIS-30422 is available in a NQFP48 package. For cooling optimizations, the NQFP has an exposed thermal pad which has to be soldered to the PCB ground plane. The ground plane needs thermal vias to conduct the heat to the bottom layer.

Figure 34 gives an example of good heat transfer. The exposed thermal pad is soldered directly on the top ground layer (left picture of Figure 34). It's advised to make the top ground layer as large as possible (see arrows Figure 34). To improve the heat transfer even more, the exposed thermal pad is connected to a bottom ground layer by using thermal vias (see right picture of Figure 34). It's advised to make this bottom ground layer as large as possible and with as less as possible interruptions.

For precise thermal cooling calculations the major thermal resistances of the device are given (Table 4). The thermal media to which the power of the devices has to be given are:

- Static environmental air (via the case)
- PCB board copper area (via the exposed pad)

The major thermal resistances of the device are the  $R_{th}$  from the junction to the ambient ( $R_{thja}$ ) and the overall  $R_{th}$  from the junction to exposed pad ( $R_{thjp}$ ). In Table 4 one can find the values for the  $R_{thja}$  and  $R_{thjp}$ , simulated according to JESD-51.

The  $R_{thja}$  for 2S2P is simulated conform JEDEC JESD-51 as follows:

- A 4-layer printed circuit board with inner power planes and outer (top and bottom) signal layers is used
- Board thickness is 1,46mm (FR4 PCB material)
- The 2 signal layers: 70  $\mu$ m thick copper with an area of 5500  $\text{mm}^2$  copper and 20% conductivity
- The 2 power internal planes: 36  $\mu$ m thick copper with an area of 5500  $\text{mm}^2$  copper and 90% conductivity

The  $R_{thja}$  for 1S0P is simulated conform to JEDEC JESD-51 as follows:

- A 1-layer printed circuit board with only 1 layer
- Board thickness is 1.46 mm (FR4 PCB material)
- The layer has a thickness of 70  $\mu$ m copper with an area of 5500  $\text{mm}^2$  copper and 20% conductivity

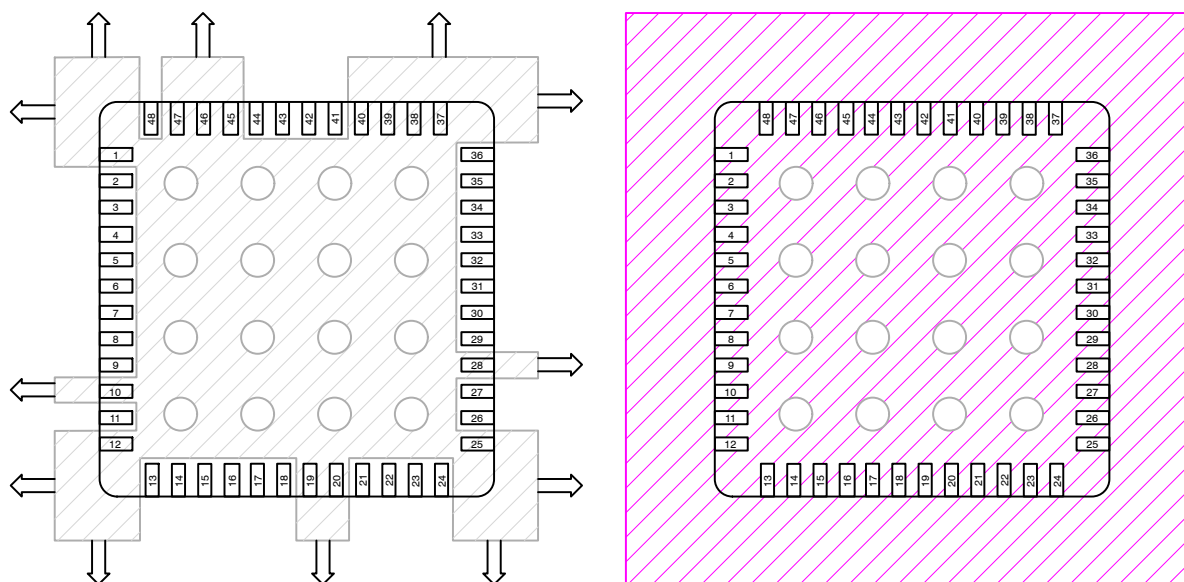

Figure 34. PCB Ground Plane Layout Condition (left picture displays the top ground layer, right picture displays the bottom ground layer)

ORDERING INFORMATION

Part No.	Peak Current	Temperature Range	Package	Shipping†
AMIS30422C422G	NA	-40°C to +170°C	NQFP-48 (7 x 7 mm) (Pb-Free)	Units / Tube
AMIS30422C422MNTWG				Tape & Reel

†For information on tape and reel specifications, including part orientation and tape sizes, please refer to our Tape and Reel Packaging Specifications Brochure, BRD8011/D.

# MECHANICAL CASE OUTLINE

## PACKAGE DIMENSIONS

ON Semiconductor®



QFN48 7x7, 0.5P  
CASE 485AJ-01  
ISSUE O

DATE 27 APR 2007

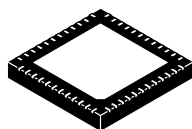

1 48

SCALE 2:1

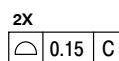
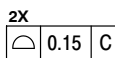
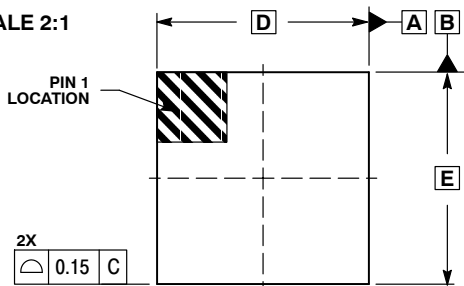

TOP VIEW

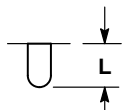

DETAIL A  
OPTIONAL CONSTRUCTION  
2X SCALE

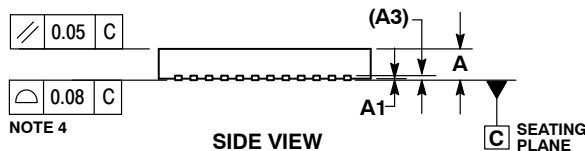

NOTE 4

SIDE VIEW

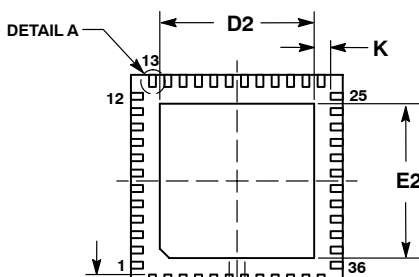

BOTTOM VIEW

$\text{M}$	0.10	C	A	B
$\text{N}$	0.05	C		

NOTE 3

NOTES:

- DIMENSIONS AND TOLERANCING PER ASME Y14.5M, 1994.
- CONTROLLING DIMENSION: MILLIMETERS.
- DIMENSION b APPLIES TO THE PLATED TERMINAL AND IS MEASURED BETWEEN 0.15 AND 0.30 MM FROM TERMINAL TIP.
- COPLANARITY APPLIES TO THE EXPOSED PAD AS WELL AS THE TERMINALS.

MILLIMETERS		
DIM	MIN	MAX
A	0.80	1.00
A1	0.00	0.05
A3	0.20 REF	
b	0.20	0.30
D	7.00 BSC	
D2	5.00	5.20
E	7.00 BSC	
E2	5.00	5.20
e	0.50 BSC	
K	0.20	---
L	0.30	0.50

GENERIC MARKING DIAGRAM\*

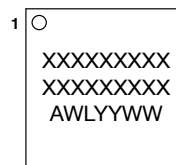

- A = Assembly Location
- WL = Wafer Lot
- YY = Year
- WW = Work Week

\*This information is generic. Please refer to device data sheet for actual part marking.  
Pb-Free indicator, "G" or microdot "•", may or may not be present.

SOLDERING FOOTPRINT\*

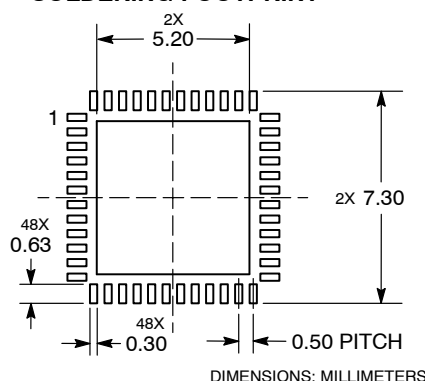

\*For additional information on our Pb-Free strategy and soldering details, please download the ON Semiconductor Soldering and Mounting Techniques Reference Manual, SOLDERRM/D.

DOCUMENT NUMBER:	98AON24490D	Electronic versions are uncontrolled except when accessed directly from the Document Repository. Printed versions are uncontrolled except when stamped "CONTROLLED COPY" in red.
DESCRIPTION:	QFN48 7X7, 0.50P	PAGE 1 OF 1

ON Semiconductor and are trademarks of Semiconductor Components Industries, LLC dba ON Semiconductor or its subsidiaries in the United States and/or other countries. ON Semiconductor reserves the right to make changes without further notice to any products herein. ON Semiconductor makes no warranty, representation or guarantee regarding the suitability of its products for any particular purpose, nor does ON Semiconductor assume any liability arising out of the application or use of any product or circuit, and specifically disclaims any and all liability, including without limitation special, consequential or incidental damages. ON Semiconductor does not convey any license under its patent rights nor the rights of others.

**onsemi**, **Onsemi**, and other names, marks, and brands are registered and/or common law trademarks of Semiconductor Components Industries, LLC dba "**onsemi**" or its affiliates and/or subsidiaries in the United States and/or other countries. **onsemi** owns the rights to a number of patents, trademarks, copyrights, trade secrets, and other intellectual property. A listing of **onsemi**'s product/patent coverage may be accessed at [www.onsemi.com/site/pdf/Patent-Marking.pdf](http://www.onsemi.com/site/pdf/Patent-Marking.pdf). **onsemi** reserves the right to make changes at any time to any products or information herein, without notice. The information herein is provided "as-is" and **onsemi** makes no warranty, representation or guarantee regarding the accuracy of the information, product features, availability, functionality, or suitability of its products for any particular purpose, nor does **onsemi** assume any liability arising out of the application or use of any product or circuit, and specifically disclaims any and all liability, including without limitation special, consequential or incidental damages. Buyer is responsible for its products and applications using **onsemi** products, including compliance with all laws, regulations and safety requirements or standards, regardless of any support or applications information provided by **onsemi**. "Typical" parameters which may be provided in **onsemi** data sheets and/or specifications can and do vary in different applications and actual performance may vary over time. All operating parameters, including "Typicals" must be validated for each customer application by customer's technical experts. **onsemi** does not convey any license under any of its intellectual property rights nor the rights of others. **onsemi** products are not designed, intended, or authorized for use as a critical component in life support systems or any FDA Class 3 medical devices or medical devices with a same or similar classification in a foreign jurisdiction or any devices intended for implantation in the human body. Should Buyer purchase or use **onsemi** products for any such unintended or unauthorized application, Buyer shall indemnify and hold **onsemi** and its officers, employees, subsidiaries, affiliates, and distributors harmless against all claims, costs, damages, and expenses, and reasonable attorney fees arising out of, directly or indirectly, any claim of personal injury or death associated with such unintended or unauthorized use, even if such claim alleges that **onsemi** was negligent regarding the design or manufacture of the part. **onsemi** is an Equal Opportunity/Affirmative Action Employer. This literature is subject to all applicable copyright laws and is not for resale in any manner.

## PUBLICATION ORDERING INFORMATION

### LITERATURE FULFILLMENT:

Email Requests to: [orderlit@onsemi.com](mailto:orderlit@onsemi.com)

**onsemi Website:** [www.onsemi.com](http://www.onsemi.com)

### TECHNICAL SUPPORT

**North American Technical Support:**

Voice Mail: 1 800-282-9855 Toll Free USA/Canada

Phone: 011 421 33 790 2910

**Europe, Middle East and Africa Technical Support:**

Phone: 00421 33 790 2910

For additional information, please contact your local Sales Representative