

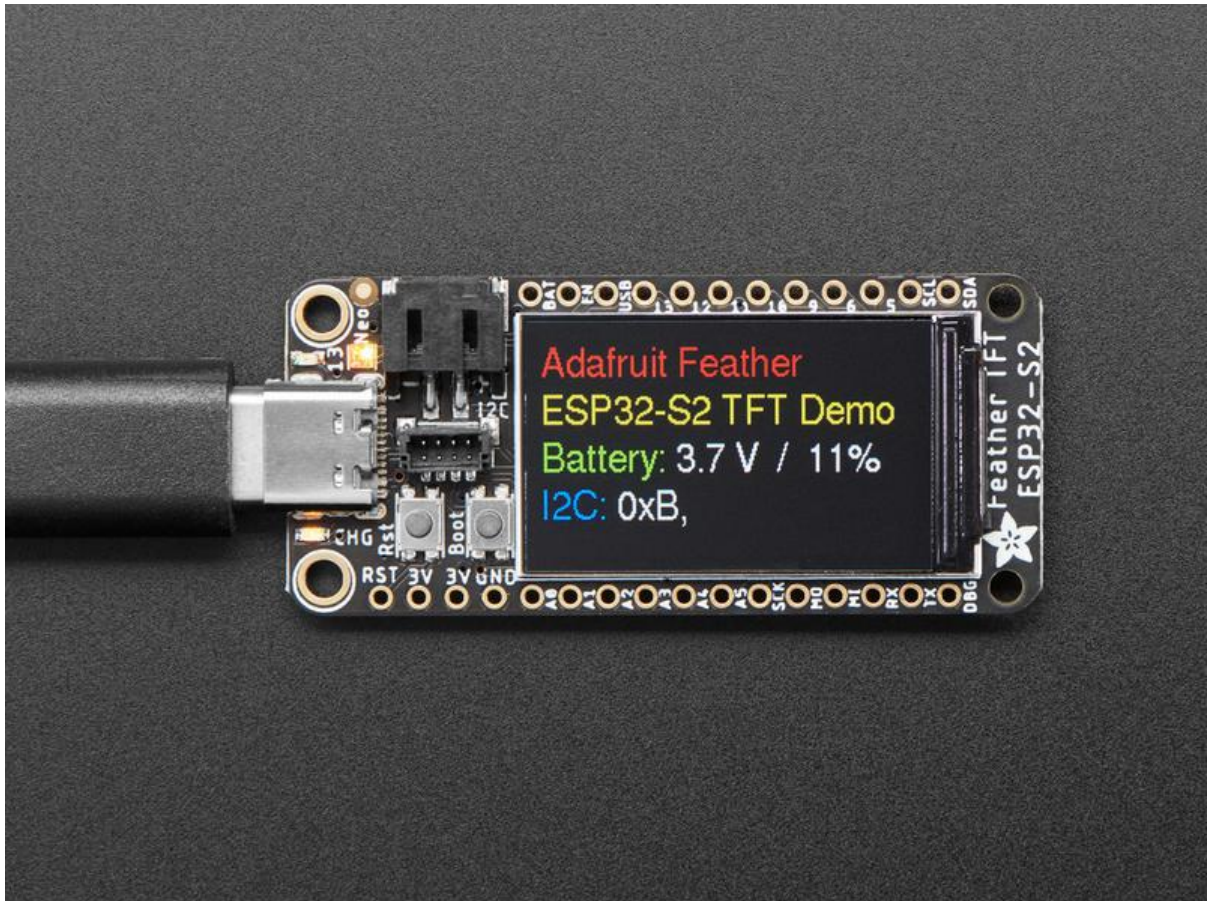

Adafruit ESP32-S2 TFT Feather

Created by Kattni Rembor



<https://learn.adafruit.com/adafruit-esp32-s2-tft-feather>

Last updated on 2023-03-16 04:10:26 PM EDT

Table of Contents

Overview	9
Pinouts	13
<ul style="list-style-type: none">• Power• TFT Display• ESP32-S2 WiFi Module• LC709203 Battery Monitor• BME280 Temperature, Humidity and Pressure Sensor• Logic Pins• NeoPixel and Red LED• STEMMA QT• Buttons• Debug	
Power Management	23
<ul style="list-style-type: none">• Battery + USB Power• Power Supplies• Measuring Battery• ENable pin• Alternative Power Options	
CircuitPython	30
<ul style="list-style-type: none">• CircuitPython Quickstart	
Installing the Mu Editor	32
<ul style="list-style-type: none">• Download and Install Mu• Starting Up Mu• Using Mu	
The CIRCUITPY Drive	35
<ul style="list-style-type: none">• Boards Without CIRCUITPY	
Creating and Editing Code	36
<ul style="list-style-type: none">• Creating Code• Editing Code• Back to Editing Code...• Naming Your Program File	
Exploring Your First CircuitPython Program	41
<ul style="list-style-type: none">• Imports & Libraries• Setting Up The LED• Loop-de-loops• What Happens When My Code Finishes Running?• What if I Don't Have the Loop?	
Connecting to the Serial Console	44
<ul style="list-style-type: none">• Are you using Mu?• Serial Console Issues or Delays on Linux• Setting Permissions on Linux• Using Something Else?	

Interacting with the Serial Console	47
The REPL	50
<ul style="list-style-type: none">• Entering the REPL• Interacting with the REPL• Returning to the Serial Console	
CircuitPython Libraries	55
<ul style="list-style-type: none">• The Adafruit Learn Guide Project Bundle• The Adafruit CircuitPython Library Bundle• Downloading the Adafruit CircuitPython Library Bundle• The CircuitPython Community Library Bundle• Downloading the CircuitPython Community Library Bundle• Understanding the Bundle• Example Files• Copying Libraries to Your Board• Understanding Which Libraries to Install• Example: ImportError Due to Missing Library• Library Install on Non-Express Boards• Updating CircuitPython Libraries and Examples• CircUp CLI Tool	
CircuitPython Documentation	66
<ul style="list-style-type: none">• CircuitPython Core Documentation• CircuitPython Library Documentation	
Recommended Editors	73
<ul style="list-style-type: none">• Recommended editors• Recommended only with particular settings or add-ons• Editors that are NOT recommended	
Advanced Serial Console on Windows	74
<ul style="list-style-type: none">• Windows 7 and 8.1• What's the COM?• Install Putty	
Advanced Serial Console on Mac	78
<ul style="list-style-type: none">• What's the Port?• Connect with screen	
Advanced Serial Console on Linux	80
<ul style="list-style-type: none">• What's the Port?• Connect with screen• Permissions on Linux	
Frequently Asked Questions	84
<ul style="list-style-type: none">• Using Older Versions• Python Arithmetic• Wireless Connectivity• Asyncio and Interrupts• Status RGB LED• Memory Issues• Unsupported Hardware	
ESP32-S2 Bugs & Limitations	90

- [Always Run the Latest Version of CircuitPython and Libraries](#)
- [I have to continue using CircuitPython 5.x or earlier. Where can I find compatible libraries?](#)
- [Bootloader \(boardnameBOOT\) Drive Not Present](#)
- [Windows Explorer Locks Up When Accessing boardnameBOOT Drive](#)
- [Copying UF2 to boardnameBOOT Drive Hangs at 0% Copied](#)
- [CIRCUITPY Drive Does Not Appear or Disappears Quickly](#)
- [Device Errors or Problems on Windows](#)
- [Serial Console in Mu Not Displaying Anything](#)
- [code.py Restarts Constantly](#)
- [CircuitPython RGB Status Light](#)
- [CircuitPython 7.0.0 and Later](#)
- [CircuitPython 6.3.0 and earlier](#)
- [Serial console showing ValueError: Incompatible .mpy file](#)
- [CIRCUITPY Drive Issues](#)
- [Safe Mode](#)
- [To erase CIRCUITPY: storage.erase_filesystem\(\)](#)
- [Erase CIRCUITPY Without Access to the REPL](#)
- [For the specific boards listed below:](#)
- [For SAMD21 non-Express boards that have a UF2 bootloader:](#)
- [For SAMD21 non-Express boards that do not have a UF2 bootloader:](#)
- [Running Out of File Space on SAMD21 Non-Express Boards](#)
- [Delete something!](#)
- [Use tabs](#)
- [On MacOS?](#)
- [Prevent & Remove MacOS Hidden Files](#)
- [Copy Files on MacOS Without Creating Hidden Files](#)
- [Other MacOS Space-Saving Tips](#)
- [Device Locked Up or Boot Looping](#)

Welcome to the Community!

110

- [Adafruit Discord](#)
- [CircuitPython.org](#)
- [Adafruit GitHub](#)
- [Adafruit Forums](#)
- [Read the Docs](#)

CircuitPython Essentials

119

Blink

120

- [LED Location](#)
- [Blinking an LED](#)

TFT Basics

123

- [CircuitPython Serial Output and REPL](#)
- [Simple Text Display](#)
- [Simple Bitmap Display](#)
- [Simple Sensor Data Display](#)

CircuitPython Internet Test

129

- [Secrets File](#)

TFT GitHub Stars WiFi Demo

134

- [GitHub Stars WiFi Demo Secrets](#)
- [Set Up CIRCUITPY](#)

- [Code Walkthrough](#)

[I2C: On-Board Battery Monitor](#) 137

- [LC709203 Location](#)
- [LC709203 Simple Data Example](#)

[Adafruit IO: Send and Receive Data](#) 139

- [NeoPixel Location](#)
- [Adafruit IO Feeds and Dashboard](#)
- [Adafruit IO Example Secrets](#)
- [Adafruit IO Example Code](#)
- [NeoPixel Color Change](#)
- [Code Walkthrough](#)

[I2C: External Sensor](#) 149

- [I2C and CircuitPython](#)
- [Necessary Hardware](#)
- [Wiring the MCP9808](#)
- [Find Your Sensor](#)
- [I2C Sensor Data](#)
- [Where's my I2C?](#)

[Analog In](#) 156

- [Analog to Digital Converter \(ADC\)](#)
- [Potentiometers](#)
- [Hardware](#)
- [Wire Up the Potentiometer](#)
- [Reading Analog Pin Values](#)
- [Reading Analog Voltage Values](#)

[NeoPixel LED](#) 163

- [NeoPixel Location](#)
- [NeoPixel Color and Brightness](#)
- [RGB LED Colors](#)
- [NeoPixel Rainbow](#)

[Digital Input](#) 168

- [LED and Button](#)
- [Controlling the LED with a Button](#)

[Storage](#) 170

- [The boot.py File](#)
- [The code.py File](#)
- [Logging the Temperature](#)
- [Recovering a Read-Only Filesystem](#)

[Capacitive Touch](#) 175

- [One Capacitive Touch Pin](#)
- [Pin Location](#)
- [Reading Touch on the Pin](#)
- [Multiple Capacitive Touch Pins](#)
- [Pin Location](#)
- [Reading Touch on the Pins](#)
- [The Available Touch-Capable Pins](#)

CPU Temperature	181
<ul style="list-style-type: none">• Microcontroller Location• Reading the Microcontroller Temperature	
Arduino IDE Setup	184
Using with Arduino IDE	187
<ul style="list-style-type: none">• Blink• Select ESP32-S2/S3 Board in Arduino IDE• Launch ESP32-S2/S3 ROM Bootloader• Load Blink Sketch	
Arduino Blink	191
<ul style="list-style-type: none">• Pre-Flight Check: Get Arduino IDE & Hardware Set Up• Start up Arduino IDE and Select Board/Port• New Blink Sketch• Verify (Compile) Sketch• Upload Sketch• Native USB and manual bootloading• Enter Manual Bootload Mode• Finally, a Blink!	
I2C Scan Test	200
<ul style="list-style-type: none">• Common I2C Connectivity Issues• Perform an I2C scan!• Wiring the MCP9808	
I2C: On-Board LC709203 Battery Monitor	204
<ul style="list-style-type: none">• Arduino Library Installation• LC709203 Simple Data Example	
Built-In TFT	207
<ul style="list-style-type: none">• Arduino Library Installation• Graphics Test Example Code	
WiFi Test	213
<ul style="list-style-type: none">• WiFi Connection Test• Secure Connection Example• JSON Parsing Demo	
Usage with Adafruit IO	225
<ul style="list-style-type: none">• Install Libraries• Adafruit IO Setup• Code Usage	
Factory Shipped Demo	233
<ul style="list-style-type: none">• Arduino Library Installation• Factory Demo Example Code	
WipperSnapper Setup	238
<ul style="list-style-type: none">• What is WipperSnapper• Sign up for Adafruit.io• Add a New Device to Adafruit IO• Feedback• Troubleshooting	

- ["Uninstalling" WipperSnapper](#)

[WipperSnapper Essentials](#) 243

[LED Blink](#) 244

- [Where is the LED on my board?](#)
- [Create a LED Component on Adafruit IO](#)
- [Usage](#)

[NeoPixel LED](#) 246

- [Where is the NeoPixel on my board?](#)
- [Create the NeoPixel Component](#)
- [Set the NeoPixel's RGB Color](#)
- [Set NeoPixel Brightness](#)

[Read a Push-button](#) 251

- [Button Location](#)
- [Create a Push-button Component on Adafruit IO](#)

[Analog Input](#) 255

- [Analog to Digital Converter \(ADC\)](#)
- [Potentiometers](#)
- [Hardware](#)
- [Wire Up the Potentiometer](#)
- [Create a Potentiometer Component on Adafruit IO](#)
- [Read Analog Pin Values](#)
- [Read Analog Pin Voltage Values](#)

[I2C Sensors](#) 262

- [Parts](#)
- [Wiring](#)
- [Add an MCP9808 Component](#)
- [Read I2C Sensor Values](#)

[Battery Monitor \(MAX17048\)](#) 267

- [Where is the Battery Monitor on my Feather?](#)
- [Powering the Feather with a Battery](#)
- [Add Battery Monitor Component to Adafruit IO](#)
- [Going Further](#)

[Battery Monitor \(LC709203F\)](#) 271

- [Where is the Battery Monitor on my Feather?](#)
- [Powering the Feather with a Battery](#)
- [Add Battery Monitor Component to Adafruit IO](#)
- [Going Further](#)

[Factory Reset](#) 274

- [Factory Reset Firmware UF2](#)
- [Factory Reset and Bootloader Repair](#)
- [Download .bin and Enter Bootloader](#)
- [Step 1. Download the factory-reset-and-bootloader.bin file](#)
- [Step 2. Enter ROM bootloader mode](#)
- [The WebSerial ESPTool Method](#)
- [Connect](#)
- [Erase the Contents](#)

- [Program the ESP32-S2/S3](#)
- [The esptool Method \(for advanced users\)](#)
- [Install ESPTool.py](#)
- [Test the Installation](#)
- [Connect](#)
- [Installing the Bootloader](#)
- [Reset the board](#)
- [Older Versions of Chrome](#)
- [The Flash an Arduino Sketch Method](#)
- [Arduino IDE Setup](#)
- [Load the Blink Sketch](#)

[Install UF2 Bootloader](#)

[286](#)

[Downloads](#)

[287](#)

- [Files](#)
- [Schematic and Fab Print](#)
- [3D Model](#)

Overview

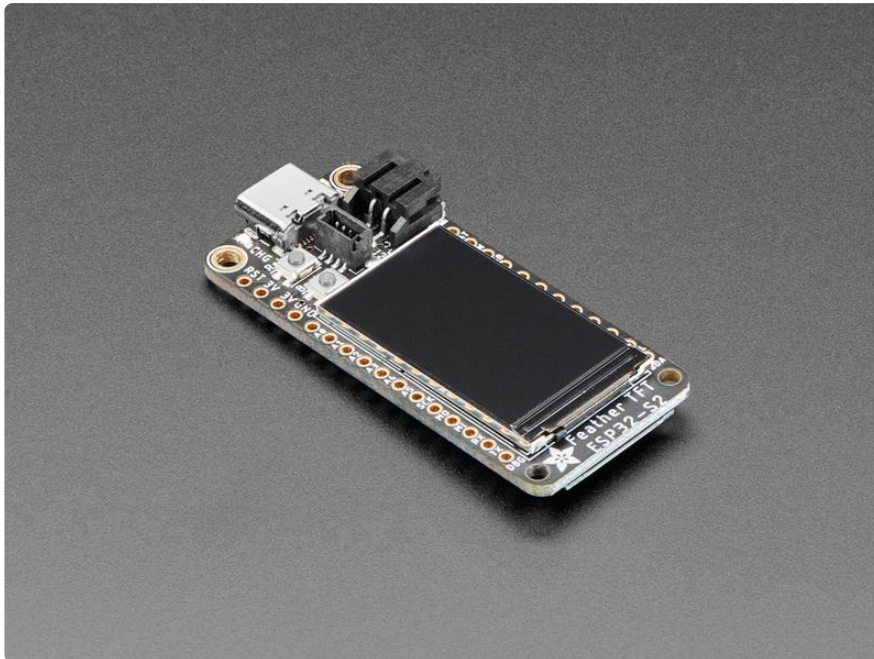

We've got a new machine here at Adafruit - it can uncover your deepest desires. Don't believe me? I'll turn it on right now to prove it to you! What, you want unlimited mozzarella sticks? Ok, well, that's not something we can provide. But we can provide your second-deepest desire: an ESP32-S2 Feather board with a built in IPS TFT color display.

It's got all the ~~gooeyness of a mozzarella stick~~ features of a Feather main board, the comforting warmth of an ESP32-S2 WiFi microcontroller, and the crispness of a 240x135 pixel color TFT display. All that and it will even plug in nicely into a breadboard, [terminal block wing \(\)](#), or [Feather Doubler \(\)](#), or even just stack on top of another 'Wing.

This Feather comes with native USB and 4 MB flash + 2 MB of PSRAM, so it is perfect for use with CircuitPython or Arduino with low-cost WiFi. Native USB means it can act like a keyboard or a disk drive. WiFi means it's awesome for IoT projects. And Feather means it works with the large community of FeatherWings for expandability.

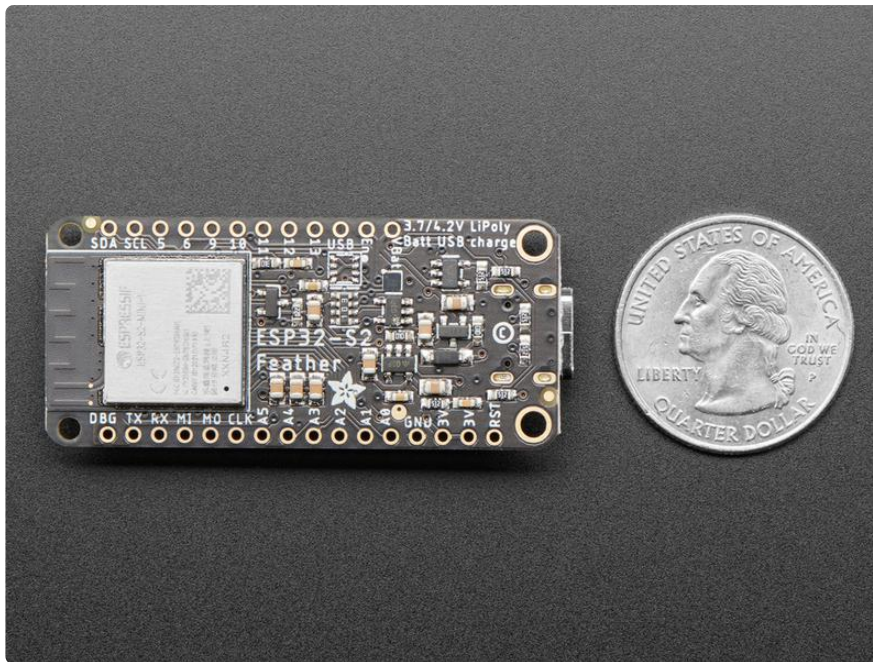

The ESP32-S2 is a highly-integrated, low-power, 2.4 GHz Wi-Fi System-on-Chip (SoC) solution that now has built-in native USB as well as some other interesting new technologies like Time of Flight distance measurements. With its state-of-the-art power and RF performance, this SoC is an ideal choice for a wide variety of application scenarios relating to the [Internet of Things \(IoT\) \(\)](#), [wearable electronics \(\)](#), and smart homes.

Please note: the Feather ESP32-S2 has a single-core 240 MHz chip, so it won't be as fast as ESP32's with dual-core. Also, there is no Bluetooth support. However, we are super excited about the ESP32-S2's native USB which unlocks a lot of capabilities for advanced interfacing! The ESP32-S2 mini-module we are using on the Feather comes with 4 MB flash and 2 MB PSRAM, so you can buffer massive JSON files for parsing!

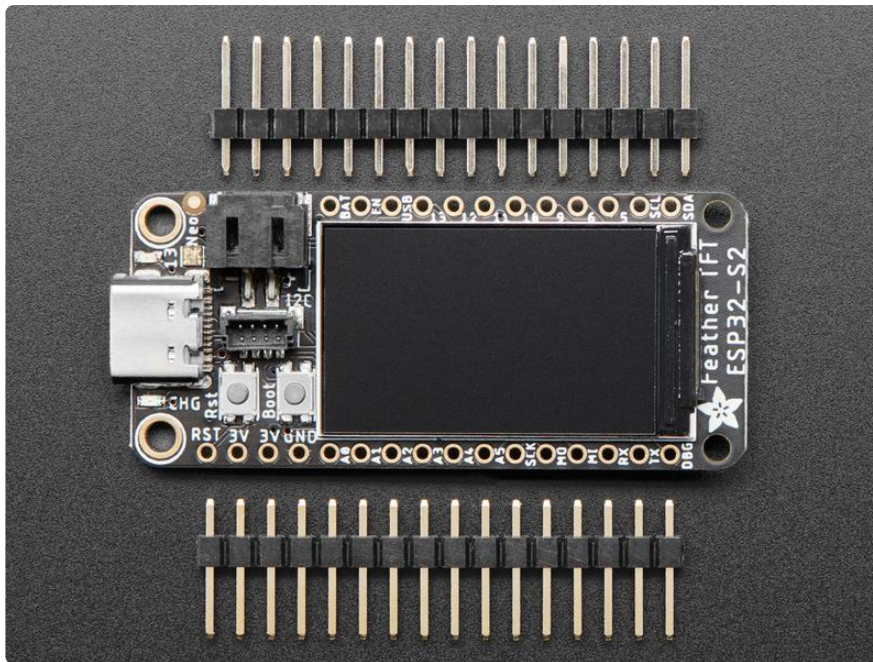

The color TFT is connected to the SPI pins, and uses additional pins for control that are not exposed to the breakout pads. [It's the same display as you see here, with 240x135 pixels and is IPS \(\)](#) so you get bright color at any angle. The backlight is also connected to a separate pin so you can PWM the backlight up and down as desired.

For low power usages, the Feather has a second AP2112 regulator. The regulator is controlled with a GPIO pin on the enable line and can shut off power to the Stemma QT port and TFT. There is also a separate power pin for the NeoPixel that can be used to disable it for even lower quiescent power. With everything off and in deep sleep mode, the TFT Feather uses about 100uA of current.

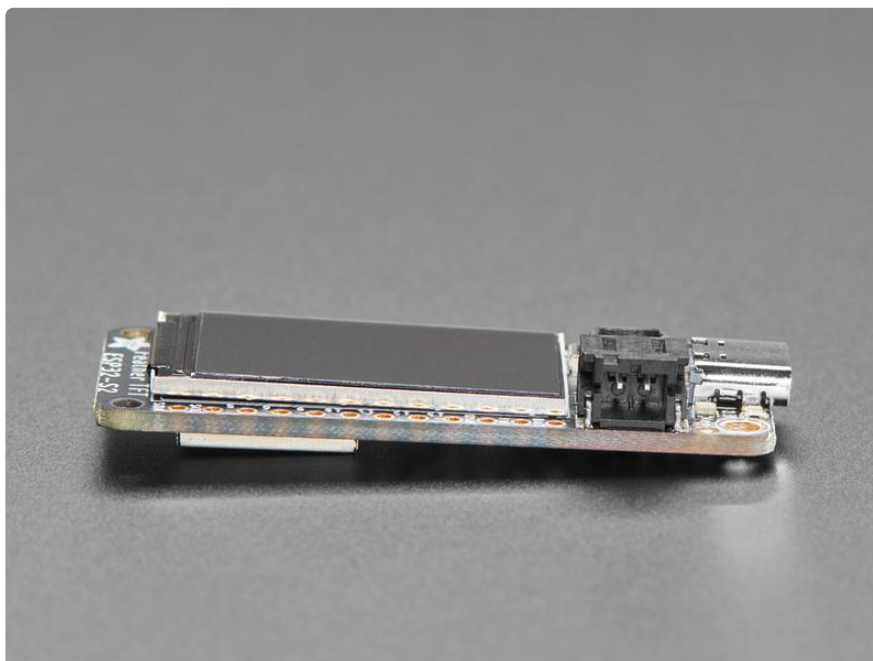

Features:

- ESP32-S2 240MHz Tensilica processor - the next generation of ESP32, now with native USB so it can act like a keyboard/mouse, MIDI device, disk drive, etc!
- Mini module has FCC/CE certification and comes with 4 MByte of Flash and 2 MByte of PSRAM - you can have huge data buffers.
- [Color 1.14" IPS TFT with 240x135 pixels \(\)](#) - bright and colorful display with ST7789 chipset that can be viewed at any angle.
- Power options - USB type C or LiPoly battery.
- Built-in battery charging when powered over USB-C.
- LiPoly battery monitor - LC709203 chip actively monitors your battery for voltage and state of charge / percentage reporting over I2C.
- Reset and DFU (BOOT0) buttons to get into the ROM bootloader (which is a USB serial port so you don't need a separate cable!)
- Serial debug output pin (optional, for checking the hardware serial debug console)
- STEMMA QT connector for I2C devices, with switchable power, so you can go into low power mode.
- On/Charge/User LEDs + status NeoPixel with pin-controlled power for low power usage.
- Low Power friendly! In deep sleep mode we can get down to 80~100uA of current draw from the LiPoly connection. Quiescent current is from the power regulator, ESP32-S2 chip, and LiPoly monitor. Turn off the NeoPixel and external I2C/TFT power for the lowest quiescent current draw.
- Works with Arduino or CircuitPython

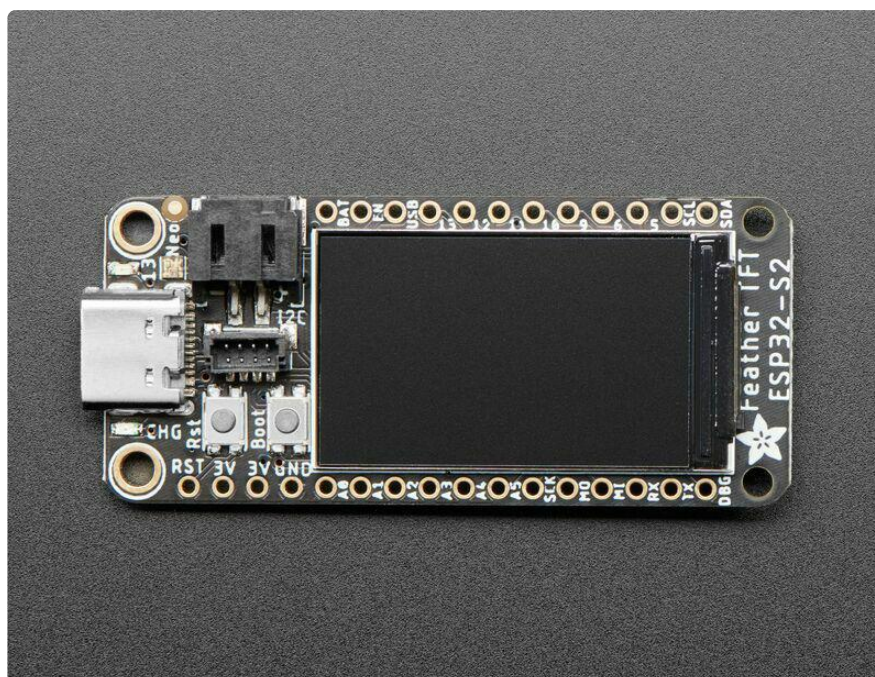

Pinouts

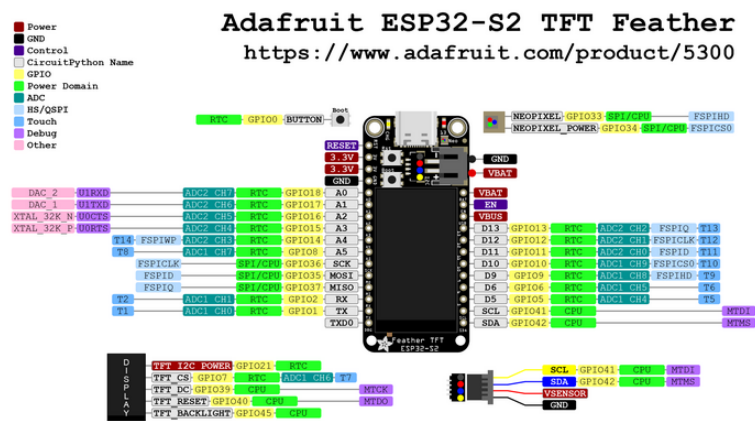
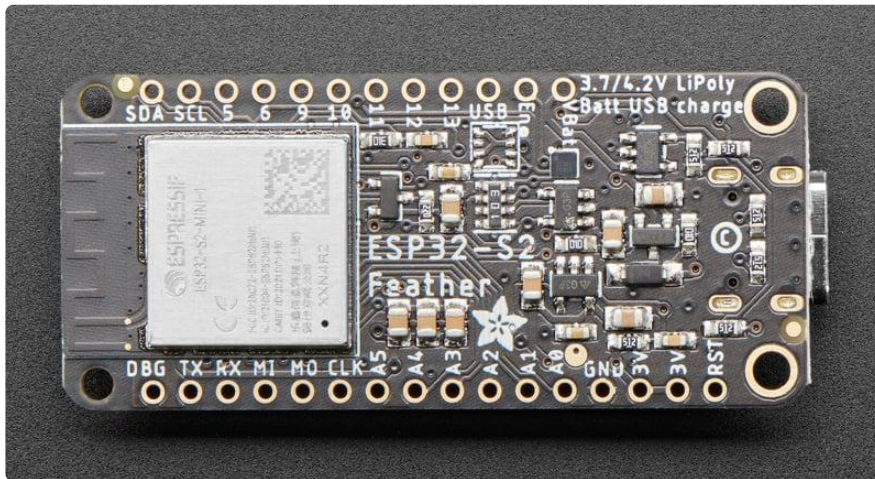
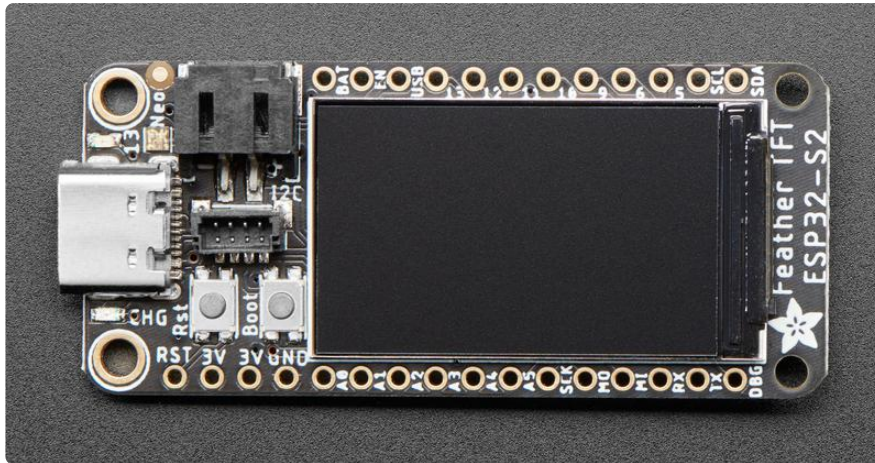

PrettyPins PDF [on GitHub](#) ().

Power

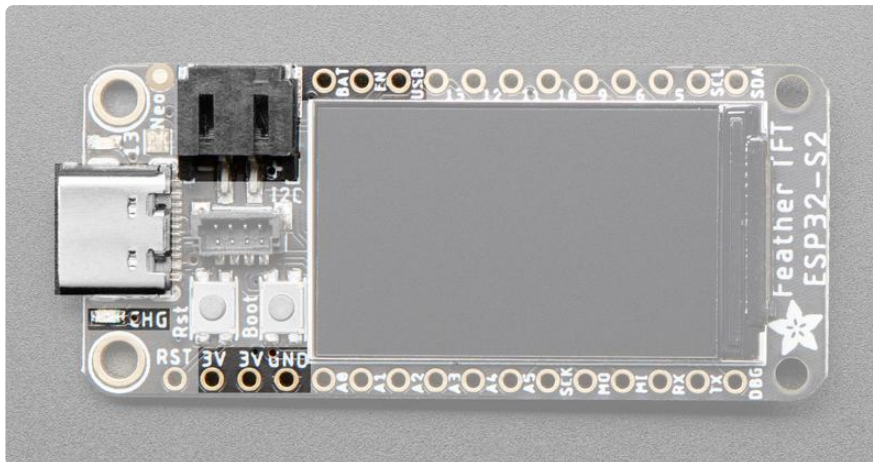

There are two ways you can power the Feather ESP32-S2, as well as other related pins.

- USB-C port - This is used for both powering and programming the board. You can power it with any USB C cable. When USB is plugged in it will charge the Lipoly battery.
- LiPoly connector/charger - You can plug in any 250mAh or larger 3.7/4.2V Lipoly battery into this JST 2-PH port to both power your Feather and charge the battery. The battery will charge from the USB power when USB is plugged in. If the battery is plugged in and USB is plugged in, the Feather will power itself from USB and it will charge the battery up.
- CHG LED - When the battery is charging, the yellow CHG LED will be lit. When charging is complete, the LED will turn off. If there's no battery plugged in, the CHD LED may blink rapidly - this is expected!
- GND - This is the common ground for all power and logic.
- BAT - This is the positive voltage to/from the 2-pin JST jack for the optional Lipoly battery.
- USB - This is the positive voltage to/from the USB C jack, if USB is connected.
- EN - This is the 3.3V regulator's enable pin. It's pulled up, so connect to ground to disable the 3.3V regulator.
- 3.3V - These pins are the output from the 3.3V regulator, they can supply 500mA peak.

TFT Display

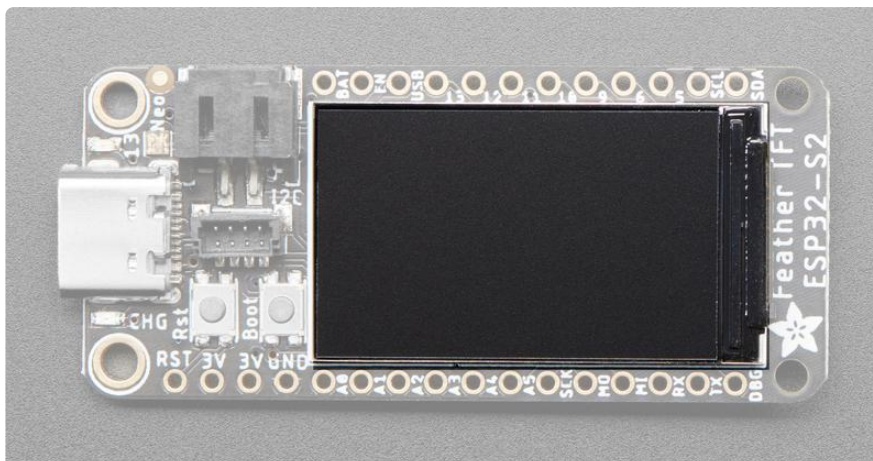

On the front of the board is a [color 1.14" IPS TFT with 240x135 pixels \(\)](#). It's a bright and colorful display with ST7789 chipset that can be viewed at any angle.

There is a power pin that must be pulled high for the display to work. This is done automatically by CircuitPython and Arduino. The pin is available in CircuitPython and in Arduino as `TFT_I2C_POWER`.

If you run into I2C or TFT power issues on Arduino, ensure you are using the latest Espressif board support package. If you are still having issues, you may need to manually pull the pin HIGH in your code.

ESP32-S2 WiFi Module

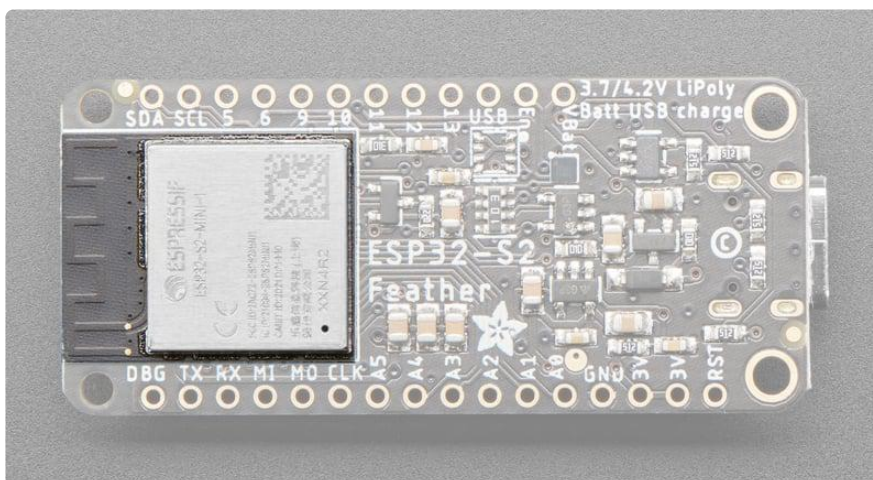

This is the ESP32-S2 module.

The ESP32-S2 is a highly-integrated, low-power, 2.4 GHz Wi-Fi System-on-Chip (SoC) solution that now has built-in native USB as well as some other interesting new technologies like Time of Flight distance measurements. With its state-of-the-art power and RF performance, this SoC is an ideal choice for a wide variety of application scenarios relating to the [Internet of Things \(IoT\) \(\)](#), [wearable electronics \(\)](#), and smart homes.

Please note, this is a single-core 240 MHz chip so it won't be as fast as ESP32's with dual-core. Also, there is no Bluetooth support. However, we are super excited about the ESP32-S2's native USB which unlocks a lot of capabilities for advanced interfacing! This module comes with 4 MB flash and 2 MB PSRAM.

The 4 MB of flash is inside the module and is used for both program firmware and filesystem storage. For example, in CircuitPython, we have 3 MB set aside for program firmware (this includes two OTA option spots as well) and a 1MB section for CircuitPython scripts and files.

LC709203 Battery Monitor

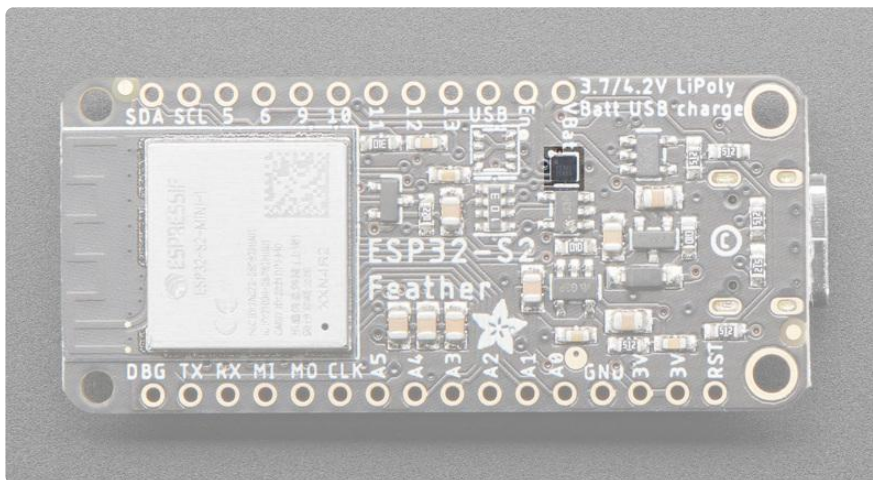

The Adafruit LC709203F LiPoly / Lilon Fuel Gauge and Battery Monitor reports the voltage and charge percent over I2C. Connect it to your [Lipoly or Lilon battery \(\)](#) and it will let you know the voltage of the cell, and it does the annoying math of decoding the non-linear voltage to get you a valid percentage as well!

The battery monitor is available over I2C on address 0x0B. Our [Arduino \(\)](#) or [CircuitPython/Python \(\)](#) library code allows you to set the pack size (mAh of the battery, this helps tune the calculation) and read the voltage and percentage whenever you like. There is no pin on the Feather ESP32-S2 that returns battery voltage, but this I2C monitor makes it super simple to get that data!

BME280 Temperature, Humidity and Pressure Sensor

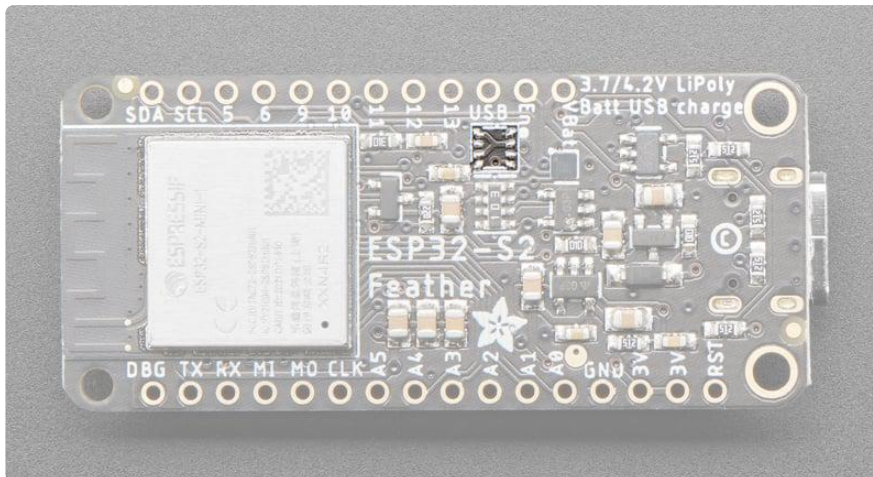

The ESP32-S2 TFT Feather comes with an unpopulated space for a BME280 Temperature, Humidity and Barometric Pressure Sensor.

There is currently no BME280 sensor shipped on the ESP32-S2 TFT Feather - only a space for it!

The sensor connects over I2C (at address 0x77), and provides immediate ambient weather sensing. It is rated for measuring humidity with $\pm 3\%$ accuracy, barometric pressure with ± 1 hPa absolute accuracy, and temperature with $\pm 1.0^\circ\text{C}$ accuracy. Because pressure changes with altitude, and the pressure measurements are so good, you can also use it as an altimeter with ± 1 meter or better accuracy!

There is a power pin that must be pulled high for the sensor to work. This is done automatically by CircuitPython and Arduino. The pin is available in CircuitPython and in Arduino as `TFT_I2C_POWER`.

If you run into I2C or TFT power issues on Arduino, ensure you are using the latest Espressif board support package. If you are still having issues, you may need to manually pull the pin HIGH in your code.

Logic Pins

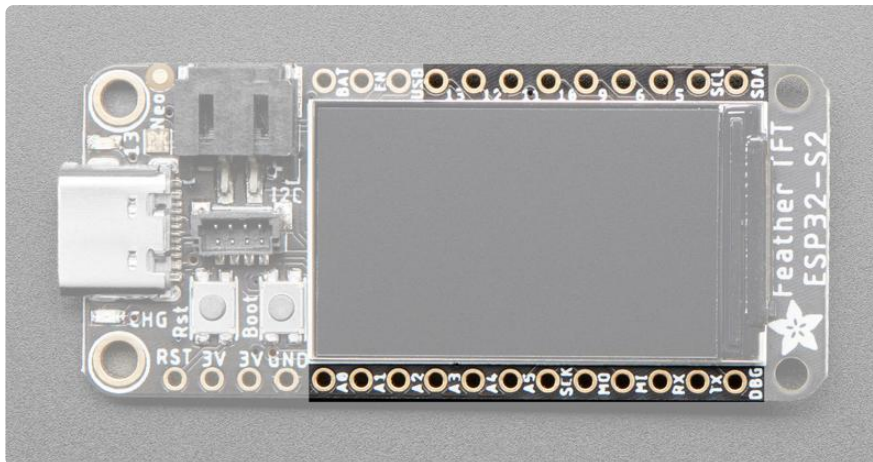

These are the logic pins that can be used to connect FeatherWings, sensors, servos, LEDs and more!

No pins are shared, and no pins are 'special' bootstrapping pins, so you can use any of them for input, or output, will pullups or pulldowns, without worry.

ESP32 chips allow for 'multiplexing' of almost all signals so it isn't like some pins can do PWM and others can. You can connect any of the available PWM channels, I2S channels, UART, I2C or SPI ports to any pin. There are some exceptions....

There are six analog pins.

- A0 and A1 are the only DAC output pins. These can be used as 8-bit true analog outputs. No other pins can do so. A0 and A1 are on ADC2.
- A2 thru A5 can also be analog inputs. A2 thru A4 are on ADC2, and A5 is on ADC1.

The SPI pins are on the ESP32-S2 high-speed peripheral. You can set any pins to be the low-speed peripheral but you won't get the speedy interface!

- SCK - This is the SPI clock pin.
- MOSI - This is the SPI Microcontroller Out / Sensor In pin.
- MISO - This is the SPI Microcontroller In / Sensor Out pin.

The UART interface.

- RX - This is the UART receive pin. Connect to TX (transmit) pin on your sensor or breakout.
- TX - This is the UART transmit pin. Connect to RX (receive) pin on your sensor or breakout.

The I2C interface. This is shared by the STEMMA QT connector.

- SCL - This is the I2C clock pin. There is a 10k pullup on this pin.
- SDA - This is the I2C data pin. There is a 10k pullup on this pin.
- In CircuitPython, you can use the STEMMA connector with `board.SCL` and `board.SDA`, or `board.STEMMA_I2C()`.
- There is an I2C power pin that needs to be pulled high for the TFT display, the BME280 sensor, and the STEMMA QT connector to work properly. It is available in CircuitPython and Arduino as `TFT_I2C_POWER`. This pin is automatically pulled high in both CircuitPython and Arduino.

The digital pins.

- D5-D6, D9-D13 - These are digital pins. D5, D6, D9 and D10 are on ADC1. D11-D13 are on ADC2.

Check the ESP32-S2 datasheet or the PrettyPins diagram above for the ADC channel names for each pin if you need em!

If you run into I2C or TFT power issues on Arduino, ensure you are using the latest Espressif board support package. If you are still having issues, you may need to manually pull the pin HIGH in your code.

NeoPixel and Red LED

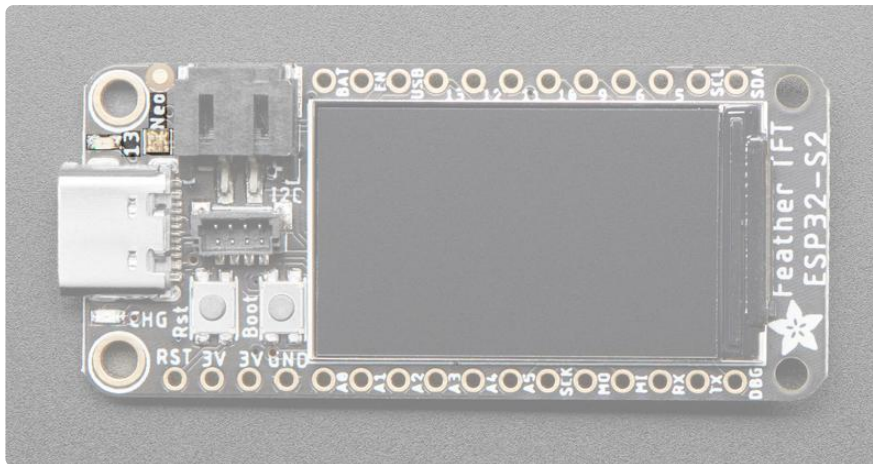

There are two LEDs you can control in code.

- NeoPixel LED - This addressable RGB NeoPixel LED, labeled Neo on the board, works both as a status LED (in CircuitPython and the bootloader), and can be controlled with code. It is available in CircuitPython as `board.NEOPIXEL`, and in Arduino as `PIN_NEOPIXEL`.
- There is a NeoPixel power pin that needs to be pulled high for the NeoPixel to work. This is done automatically by CircuitPython and Arduino. It is available in CircuitPython and Arduino as `NEOPIXEL_POWER`.

If you run into NeoPixel power issues on Arduino, ensure you are using the latest Espressif board support package. If you are still having issues, you may need to manually pull the pin high in your code.

- Red LED - This little red LED, labeled #13 on the board, is on or blinks during certain operations (such as pulsing when in the bootloader), and is controllable in code. It is available in CircuitPython as `board.LED`, and in Arduino as `LED_BUILTIN` or `13`.

STEMMA QT

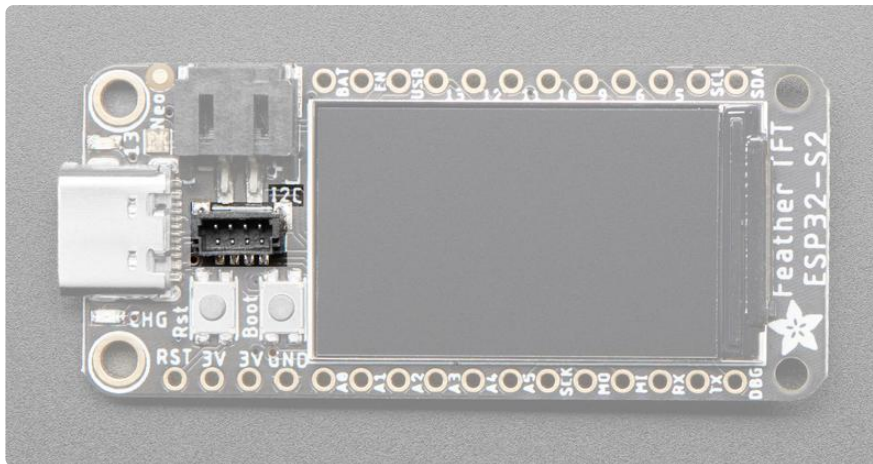

This JST SH 4-pin [STEMMA QT](#) () connector breaks out I2C (SCL, SDA, 3.3V, GND). It allows you to connect to [various breakouts and sensors with STEMMA QT connectors](#) () or to other things using [assorted associated accessories](#) (). It works great with any STEMMA QT or Qwiic sensor/device. You can also use it with Grove I2C devices thanks to [this handy cable](#) ().

There is a power pin that must be pulled high for the STEMMA QT connector to work. This is done automatically by CircuitPython and Arduino. The pin is available in CircuitPython and in Arduino as `TFT_I2C_POWER`.

If you run into I2C or TFT power issues on Arduino, ensure you are using the latest Espressif board support package. If you are still having issues, you may need to manually pull the pin HIGH in your code.

Buttons

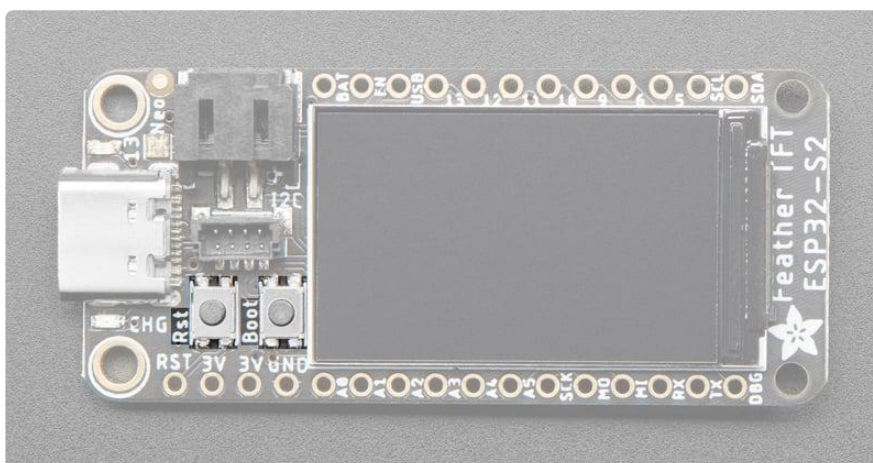

There are two buttons on the ESP32-S2 TFT Feather.

- Reset button - This button restarts the board and helps enter the bootloader. You can click it once to reset the board without unplugging the USB cable or battery. Tap once, and then tap again while the NeoPixel status LED is purple to enter the UF2 bootloader (needed to load CircuitPython).
- The RST pin is can be used to reset the board. Tie to ground manually to reset the board.
- Boot button - This button can be used as an input, or to put the board into ROM bootloader mode. It is available in CircuitPython as `board.BUTTON`, and Arduino as `0`. To enter ROM bootloader mode, hold down DFU button while clicking reset button mentioned above. When in the ROM bootloader, you can upload code and query the chip using `esptool`.

Debug

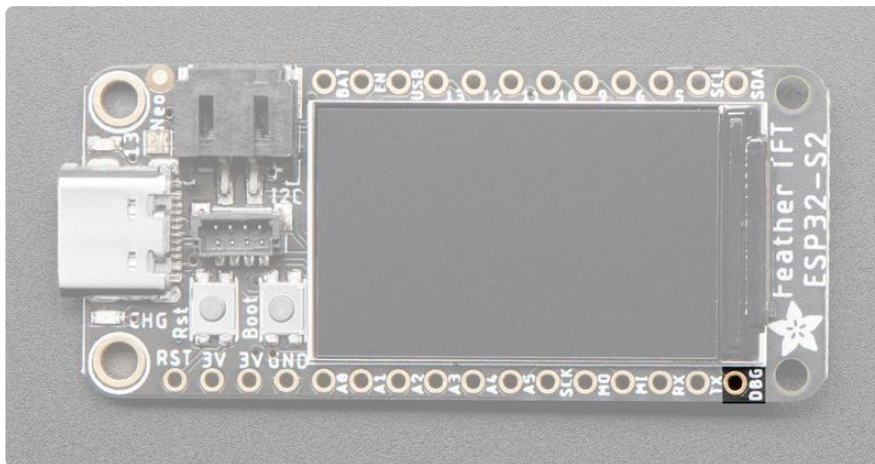

This is the Debug TX (DBG) pin. This is the hardware UART debug pin. [You can connect this to a USB console cable in order to read the debug output from the ESP32 IDF \(\)](#). This is useful if you are writing software and need to see the low level debug output.

This is not where default `Serial.print()` or CircuitPython `print()` outputs go - those will go through the USB port instead!

Power Management

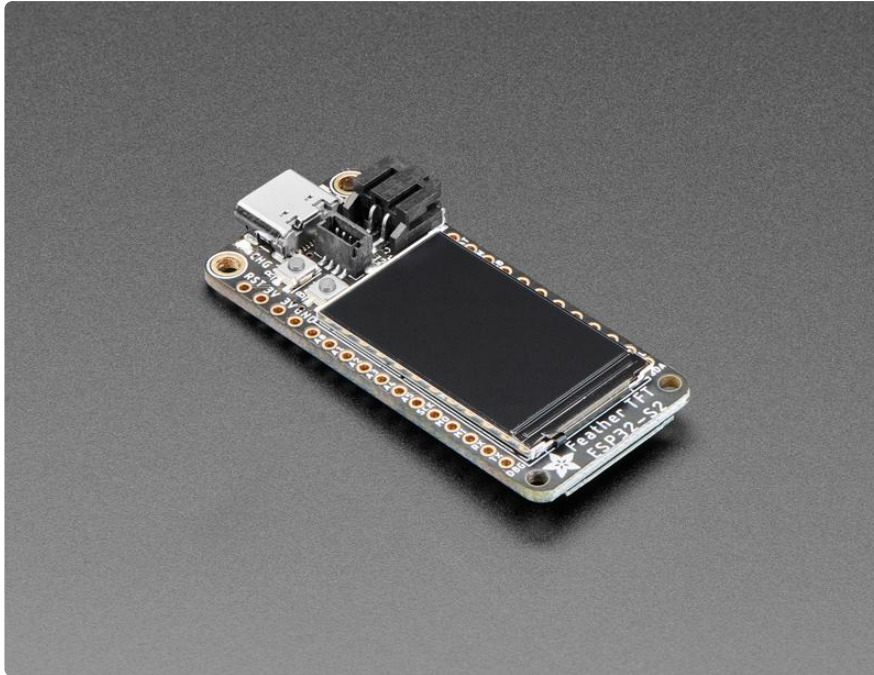

Battery + USB Power

We wanted to make our Feather boards easy to power both when connected to a computer as well as via battery.

There's two ways to power a Feather:

1. You can connect with a USB cable (just plug into the jack) and the Feather will regulate the 5V USB down to 3.3V.
2. You can also connect a 4.2/3.7V Lithium Polymer (LiPo/LiPoly) or Lithium Ion (Lilon) battery to the JST jack. This will let the Feather run on a rechargeable battery.

When the USB power is powered, it will automatically switch over to USB for power, as well as start charging the battery (if attached). This happens 'hot-swap' style so you can always keep the LiPoly connected as a 'backup' power that will only get used when USB power is lost.

The JST connector polarity is matched to Adafruit LiPoly batteries. Using wrong polarity batteries can destroy your Feather.

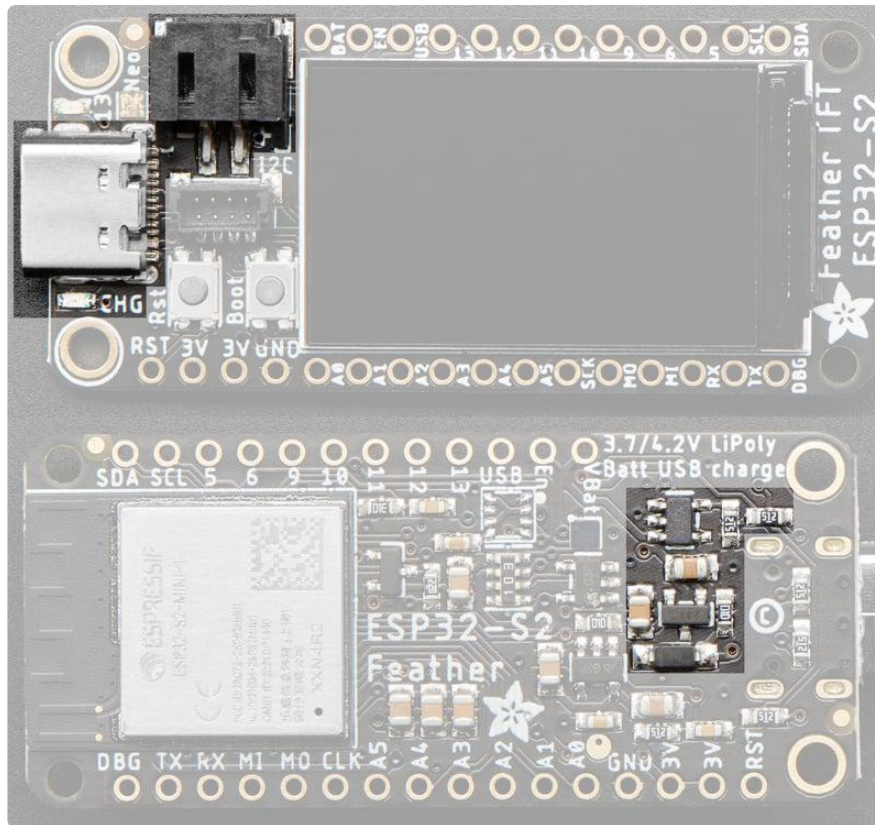

The above shows the USB-C jack (left), LiPoly JST jack (top left), as well as the changeover diode (just to the right of the JST jack) and the LiPoly charging circuitry (to the right of the JST jack).

There's also a CHG LED next to the USB jack, which will light up while the battery is charging. This LED might also flicker if the battery is not connected, it's normal.

The charge LED is automatically driven by the LiPoly charger circuit. It will try to detect a battery and is expecting one to be attached. If there isn't one it may flicker once in a while when you use power because it's trying to charge a (non-existent) battery. It's not harmful, and it's totally normal!

Power Supplies

You have a lot of power supply options here! We bring out the BAT pin, which is tied to the LiPoly JST connector, as well as USB which is the +5V from USB if connected. We also have the 3V pin which has the output from the 3.3V regulator. We use a 500mA peak regulator. While you can get 500mA from it, you can't do it continuously from 5V as it will overheat the regulator.

It's fine for, say, powering an ESP8266 WiFi chip or XBee radio though, since the current draw is 'spikey' & sporadic.

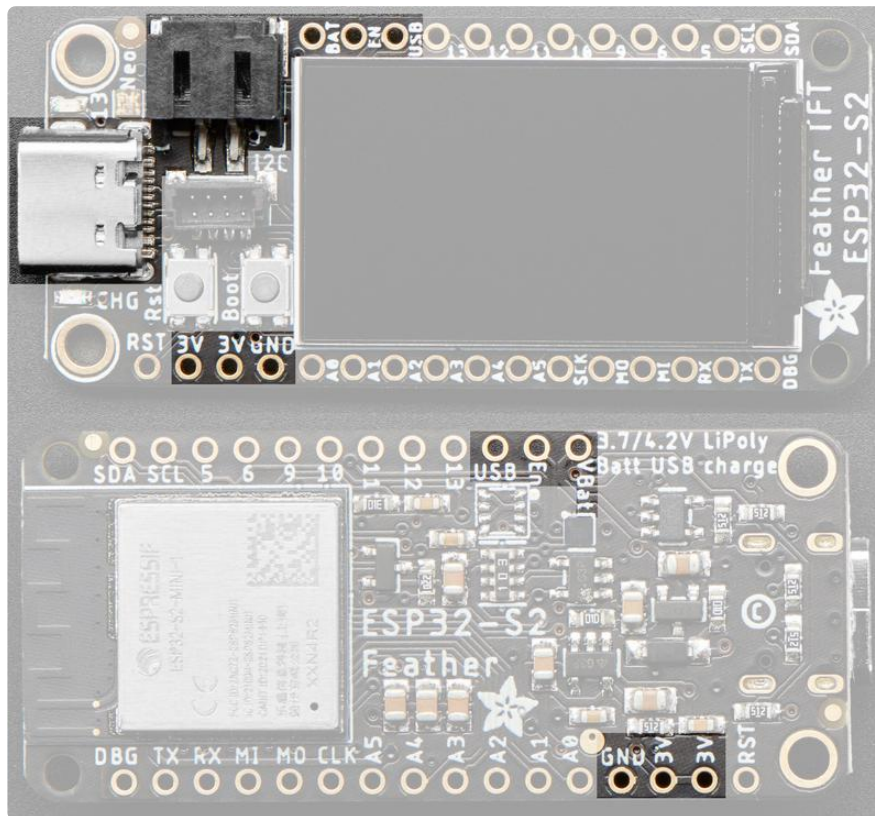

Measuring Battery

If you're running off of a battery, chances are you want to know what the voltage is at! That way you can tell when the battery needs recharging. LiPo batteries are 'maxed out' at 4.2V and stick around 3.7V for much of the battery life, then slowly sink down to 3.2V or so before the protection circuitry cuts it off. By measuring the voltage you can quickly tell when you're heading below 3.7V.

This board includes an MAX17048 Battery Monitor OR an LC709203F Battery Monitor that reports the voltage and charge percent over I2C. (You will not have both.)

The MAX17048 battery monitor is available over I2C on address 0x36.

The LC709203 battery monitor is available over I2C on address 0x0B.

Our [Arduino MAX1704x \(\)](#) or [CircuitPython/Python MAX1704x \(\)](#) library code allows you to read the voltage and percentage whenever you like.

Our [Arduino LC709203F \(\)](#) or [CircuitPython/Python LC709203F \(\)](#) library code allows you to set the pack size (mAh of the battery which helps tune the calculation), and read the voltage and percentage whenever you like.

There is no pin on this board that returns battery voltage, but this I2C monitor makes it super simple to get that data!

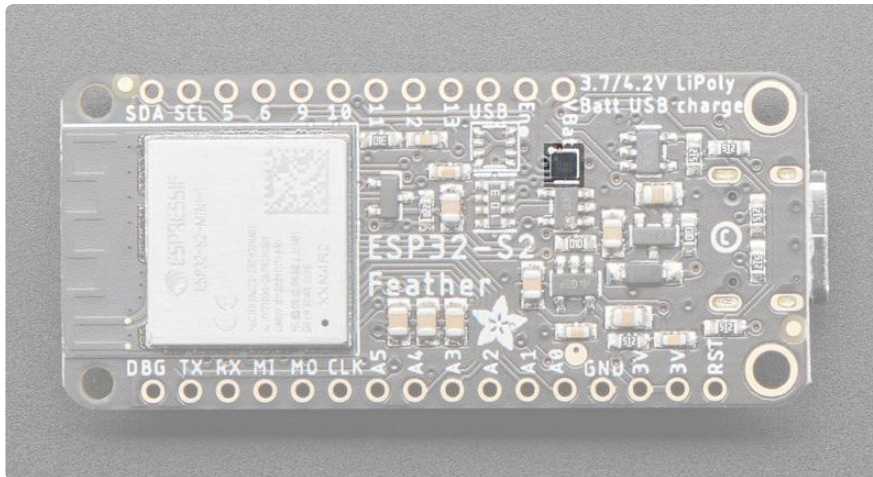

In Arduino, you can measure the battery voltage using the following script.

```
// SPDX-FileCopyrightText: 2023 Liz Clark for Adafruit Industries
//
// SPDX-License-Identifier: MIT
//
// Adafruit Battery Monitor Demo
// Checks for MAX17048 or LC709203F

#include <Wire.h>
#include "Adafruit_MAX1704X.h"
#include "Adafruit_LC709203F.h"

Adafruit_MAX17048 maxlipo;
Adafruit_LC709203F lc;

// MAX17048 i2c address
bool addr0x36 = true;

void setup() {
  Serial.begin(115200);
  while (!Serial) delay(10); // wait until serial monitor opens
  Serial.println(F("\nAdafruit Battery Monitor simple demo"));
  // if no max17048..
  if (!maxlipo.begin()) {
    Serial.println(F("Couldnt find Adafruit MAX17048, looking for LC709203F.."));
    // if no lc709203f..
    if (!lc.begin()) {
      Serial.println(F("Couldnt find Adafruit MAX17048 or LC709203F.."));
      while (1) delay(10);
    }
  }
  // found lc709203f!
  else {
    addr0x36 = false;
    Serial.println(F("Found LC709203F"));
    Serial.print("Version: 0x"); Serial.println(lc.getICversion(), HEX);
    lc.setThermistorB(3950);
  }
}
```

```

        Serial.print("Thermistor B = "); Serial.println(lc.getThermistorB());
        lc.setPackSize(LC709203F_APA_500MAH);
        lc.setAlarmVoltage(3.8);
    }
    // found max17048!
}
else {
    addr0x36 = true;
    Serial.print(F("Found MAX17048"));
    Serial.print(F(" with Chip ID: 0x"));
    Serial.println(maxlipo.getChipID(), HEX);
}
}

void loop() {
    // if you have the max17048..
    if (addr0x36 == true) {
        max17048();
    }
    // if you have the lc709203f..
    else {
        lc709203f();
    }

    delay(2000); // dont query too often!
}

void lc709203f() {
    Serial.print("Batt_Voltage:");
    Serial.print(lc.cellVoltage(), 3);
    Serial.print("\t");
    Serial.print("Batt_Percent:");
    Serial.print(lc.cellPercent(), 1);
    Serial.print("\t");
    Serial.print("Batt_Temp:");
    Serial.println(lc.getCellTemperature(), 1);
}

void max17048() {
    Serial.print(F("Batt Voltage: ")); Serial.print(maxlipo.cellVoltage(), 3);
    Serial.println(" V");
    Serial.print(F("Batt Percent: ")); Serial.print(maxlipo.cellPercent(), 1);
    Serial.println(" %");
    Serial.println();
}
}

```

For CircuitPython, you can measure it like this.

```

# SPDX-FileCopyrightText: Copyright (c) 2023 Kattni Rembor for Adafruit Industries
#
# SPDX-License-Identifier: Unlicense

import time
import board
from adafruit_max1704x import MAX17048
from adafruit_lc709203f import LC709203F, PackSize

#
i2c = board.I2C()
while not i2c.try_lock():
    pass
i2c_address_list = i2c.scan()
i2c.unlock()

device = None

```

```

if 0x0b in i2c_address_list:
    lc709203 = LC709203F(board.I2C())
    # Update to match the mAh of your battery for more accurate readings.
    # Can be MAH100, MAH200, MAH400, MAH500, MAH1000, MAH2000, MAH3000.
    # Choose the closest match. Include "PackSize." before it, as shown.
    lc709203.pack_size = PackSize.MAH400

    device = lc709203

elif 0x36 in i2c_address_list:
    max17048 = MAX17048(board.I2C())

    device = max17048

else:
    raise Exception("Battery monitor not found.")

while device:
    print(f"Battery voltage: {device.cell_voltage:.2f} Volts")
    print(f"Battery percentage: {device.cell_percent:.1f} %")
    print("")
    time.sleep(1)

```

ENable pin

If you'd like to turn off the 3.3V regulator, you can do that with the EN(able) pin. Simply tie this pin to Ground and it will disable the 3V regulator. The BAT and USB pins will still be powered.

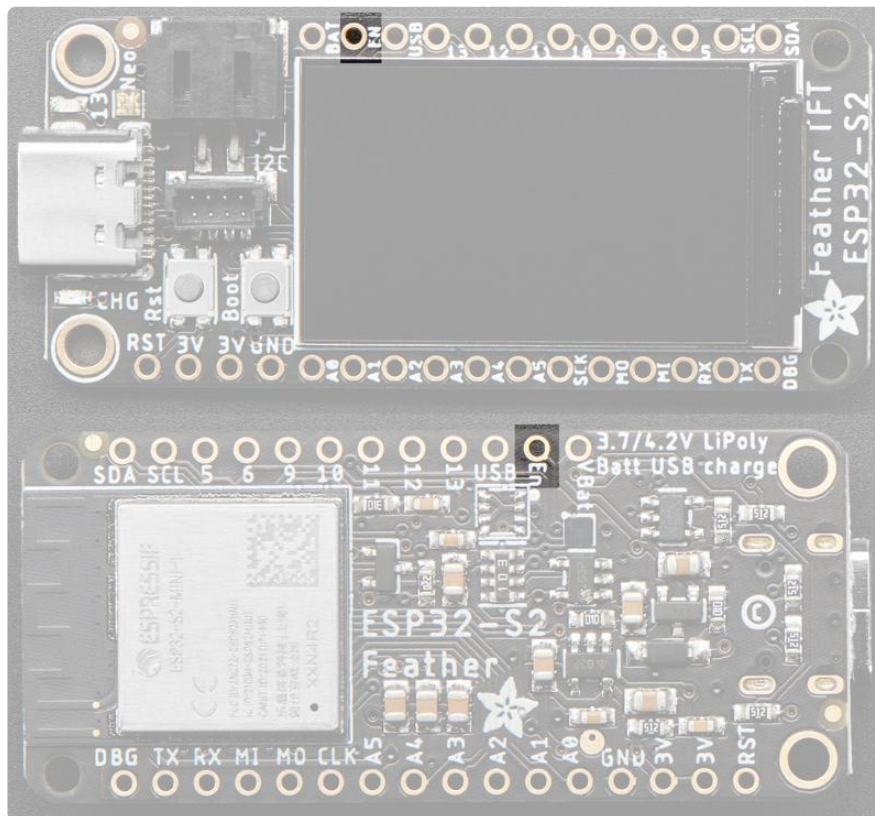

STEMMA QT and NeoPixel Power

The ESP32-S2 TFT Feather is equipped with a STEMMA QT port and NeoPixel which are both connected to their own regulators. Unlike the one controlled by the ENable pin, these two are controlled by GPIO. They are enabled by default in CircuitPython and Arduino. You can disable it manually for low power usage. The STEMMA pin is available in CircuitPython and Arduino as `TFT_I2C_POWER`. The NeoPixel pin is available in CircuitPython and Arduino as `NEOPIXEL_POWER`.

If you run into I2C or NeoPixel power issues on Arduino, ensure you are using the latest Espressif board support package. If you are still having issues, you may need to manually pull the pin high in your code.

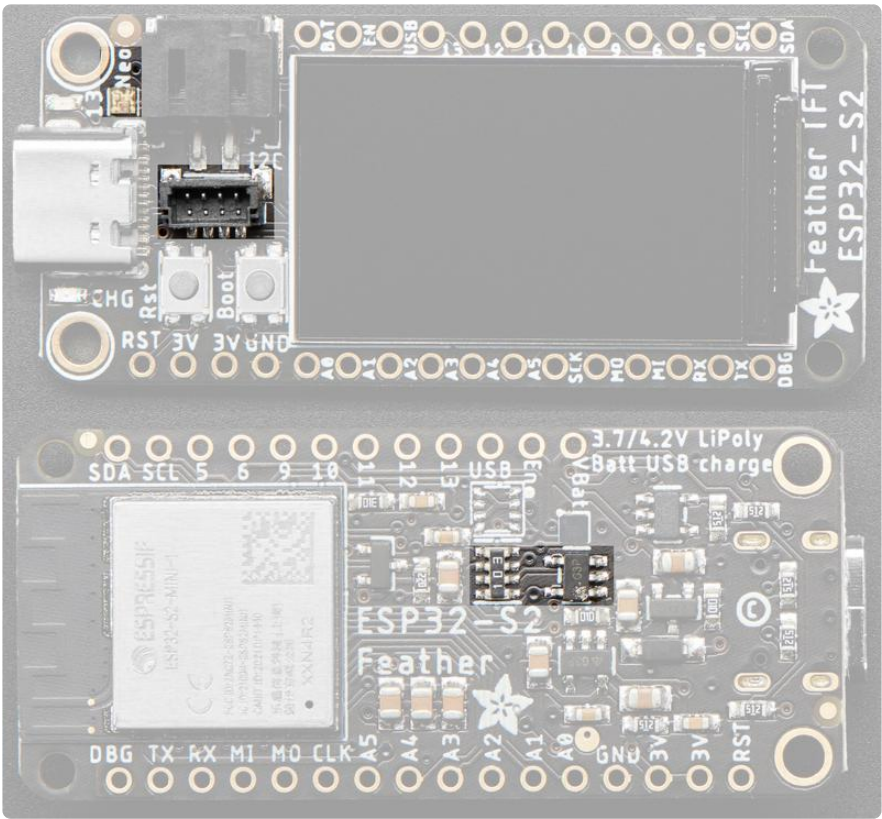

Alternative Power Options

The two primary ways for powering a feather are a 3.7/4.2V LiPo battery plugged into the JST port or a USB power cable.

If you need other ways to power the Feather, here's what we recommend:

- For permanent installations, a [5V 1A USB wall adapter \(\)](#) will let you plug in a USB cable for reliable power
- For mobile use, where you don't want a LiPoly, [use a USB battery pack! \(\)](#)
- If you have a higher voltage power supply, [use a 5V buck converter \(\)](#) and wire it to a [USB cable's 5V and GND input \(\)](#)

Here's what you cannot do:

- Do not use alkaline or NiMH batteries and connect to the battery port - this will destroy the LiPoly charger and there's no way to disable the charger
- Do not use 7.4V RC batteries on the battery port - this will destroy the board

The Feather is not designed for external power supplies - this is a design decision to make the board compact and low cost. It is not recommended, but technically possible:

- Connect an external 3.3V power supply to the 3V and GND pins. Not recommended, this may cause unexpected behavior and the EN pin will no longer work. Also this doesn't provide power on BAT or USB and some Feathers/Wings use those pins for high current usages. You may end up damaging your Feather.
- Connect an external 5V power supply to the USB and GND pins. Not recommended, this may cause unexpected behavior when plugging in the USB port because you will be back-powering the USB port, which could confuse or damage your computer.

CircuitPython

[CircuitPython \(\)](#) is a derivative of [MicroPython \(\)](#) designed to simplify experimentation and education on low-cost microcontrollers. It makes it easier than ever to get prototyping by requiring no upfront desktop software downloads. Simply copy and edit files on the CIRCUITPY drive to iterate.

CircuitPython Quickstart

Follow this step-by-step to quickly get CircuitPython running on your board.

Download the latest version of CircuitPython for this board via circuitpython.org

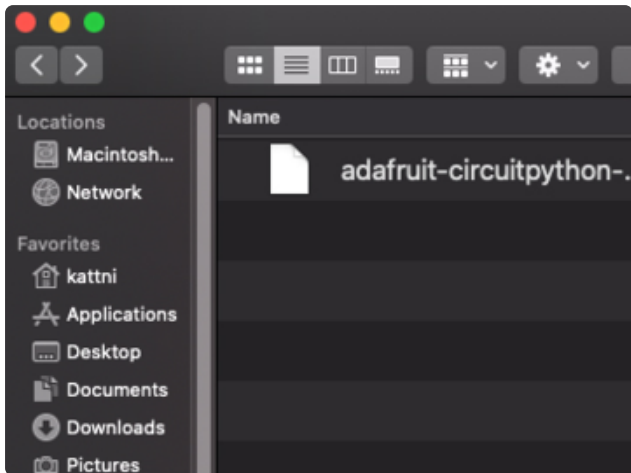

Click the link above to download the latest CircuitPython UF2 file.

Save it wherever is convenient for you.

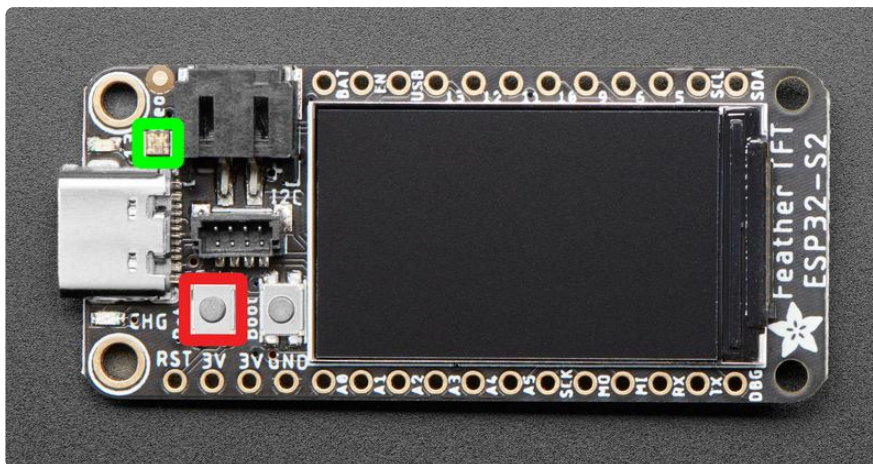

Plug your board into your computer, using a known-good data-sync cable, directly, or via an adapter if needed.

Double-click the reset button (highlighted in red above), and you will see the RGB status LED(s) turn green (highlighted in green above). If you see red, try another port, or if you're using an adapter or hub, try without the hub, or different adapter or hub.

For this board, tap reset and wait for the LED to turn purple, and as soon as it turns purple, tap reset again. The second tap needs to happen while the LED is still purple.

If double-clicking doesn't work the first time, try again. Sometimes it can take a few tries to get the rhythm right!

A lot of people end up using charge-only USB cables and it is very frustrating! Make sure you have a USB cable you know is good for data sync.

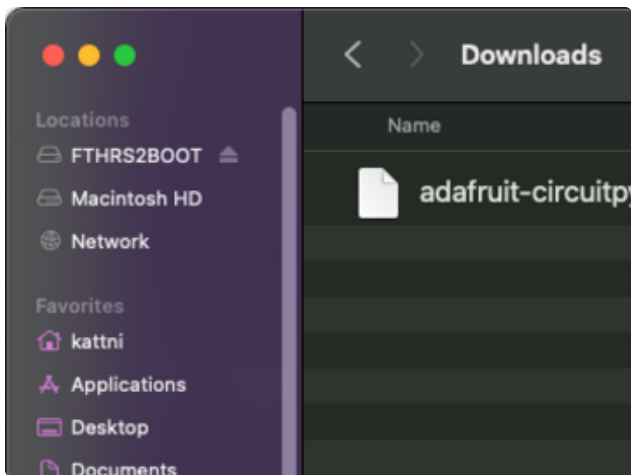

You will see a new disk drive appear called FTHRS2BOOT.

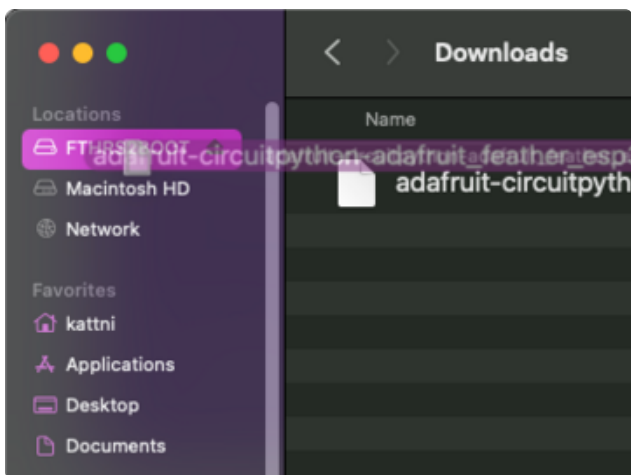

Drag the adafruit_circuitpython_etc.uf2 file to FTHRS2BOOT.

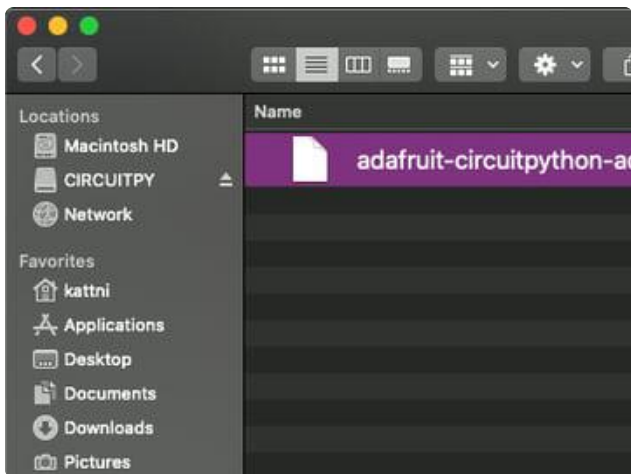

The BOOT drive will disappear and a new disk drive called CIRCUITPY will appear.

That's it!

Installing the Mu Editor

Mu is a simple code editor that works with the Adafruit CircuitPython boards. It's written in Python and works on Windows, MacOS, Linux and Raspberry Pi. The serial console is built right in so you get immediate feedback from your board's serial output!

Mu is our recommended editor - please use it (unless you are an experienced coder with a favorite editor already!).

Download and Install Mu



Download Mu from <https://codewith.mu/> ().

Click the Download link for downloads and installation instructions.

Click Start Here to find a wealth of other information, including extensive tutorials and and how-to's.

Windows users: due to the nature of MSI installers, please remove old versions of Mu before installing the latest version.

Ubuntu users: Mu currently (checked May 4, 2022) does not install properly on Ubuntu 22.04. See <https://github.com/mu-editor/mu/issues> to track this issue. See <https://learn.adafruit.com/welcome-to-circuitpython/recommended-editors> and <https://learn.adafruit.com/welcome-to-circuitpython/pycharm-and-circuitpython> for other editors to use.

Starting Up Mu

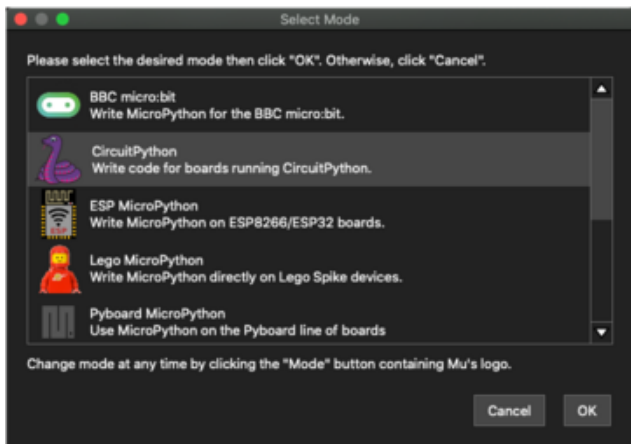

The first time you start Mu, you will be prompted to select your 'mode' - you can always change your mind later. For now please select CircuitPython!

The current mode is displayed in the lower right corner of the window, next to the "gear" icon. If the mode says "Microbit" or something else, click the Mode button in the upper left, and then choose "CircuitPython" in the dialog box that appears.

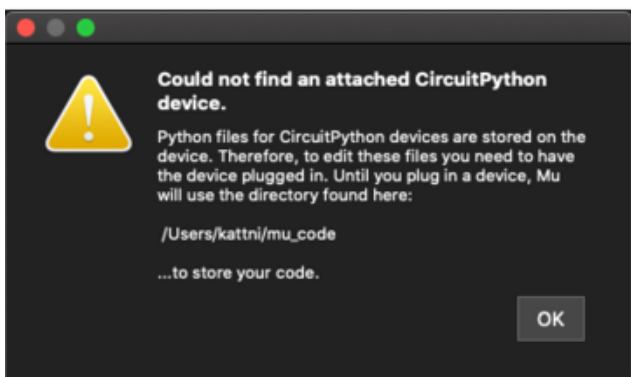

Mu attempts to auto-detect your board on startup, so if you do not have a CircuitPython board plugged in with a CIRCUITPY drive available, Mu will inform you where it will store any code you save until you plug in a board.

To avoid this warning, plug in a board and ensure that the CIRCUITPY drive is mounted before starting Mu.

Using Mu

You can now explore Mu! The three main sections of the window are labeled below; the button bar, the text editor, and the serial console / REPL.



Now you're ready to code! Let's keep going...

The CIRCUITPY Drive

When CircuitPython finishes installing, or you plug a CircuitPython board into your computer with CircuitPython already installed, the board shows up on your computer as a USB drive called CIRCUITPY.

The CIRCUITPY drive is where your code and the necessary libraries and files will live. You can edit your code directly on this drive and when you save, it will run automatically. When you create and edit code, you'll save your code in a `code.py` file located on the CIRCUITPY drive. If you're following along with a Learn guide, you can paste the contents of the tutorial example into `code.py` on the CIRCUITPY drive and save it to run the example.

With a fresh CircuitPython install, on your CIRCUITPY drive, you'll find a `code.py` file containing `print("Hello World!")` and an empty `lib` folder. If your CIRCUITPY drive does not contain a `code.py` file, you can easily create one and save it to the drive. CircuitPython looks for `code.py` and executes the code within the file automatically when the board starts up or resets. Following a change to the contents of CIRCUITPY, such as making a change to the `code.py` file, the board will reset, and the code will be run. You do not need to manually run the code. This is what makes it so easy to get started with your project and update your code!

Note that all changes to the contents of CIRCUITPY, such as saving a new file, renaming a current file, or deleting an existing file will trigger a reset of the board.

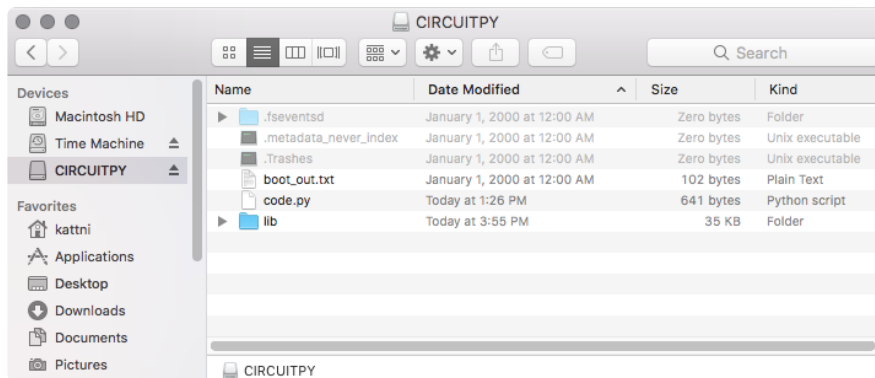

Boards Without CIRCUITPY

CircuitPython is available for some microcontrollers that do not support native USB. Those boards cannot present a CIRCUITPY drive. This includes boards using ESP32 or ESP32-C3 microcontrollers.

On these boards, there are alternative ways to transfer and edit files. You can use the [Thonny editor](#) (), which uses hidden commands sent to the REPL to read and write files. Or you can use the CircuitPython web workflow, introduced in Circuitpython 8. The web workflow provides browser-based WiFi access to the CircuitPython filesystem. These guides will help you with the web workflow:

- [CircuitPython on ESP32 Quick Start](#) ()
- [CircuitPython Web Workflow Code Editor Quick Start](#) ()

Creating and Editing Code

One of the best things about CircuitPython is how simple it is to get code up and running. This section covers how to create and edit your first CircuitPython program.

To create and edit code, all you'll need is an editor. There are many options. Adafruit strongly recommends using Mu! It's designed for CircuitPython, and it's really simple and easy to use, with a built in serial console!

If you don't or can't use Mu, there are a number of other editors that work quite well. The [Recommended Editors page](#) () has more details. Otherwise, make sure you do "Eject" or "Safe Remove" on Windows or "sync" on Linux after writing a file if you aren't using Mu. (This is not a problem on MacOS.)

Creating Code

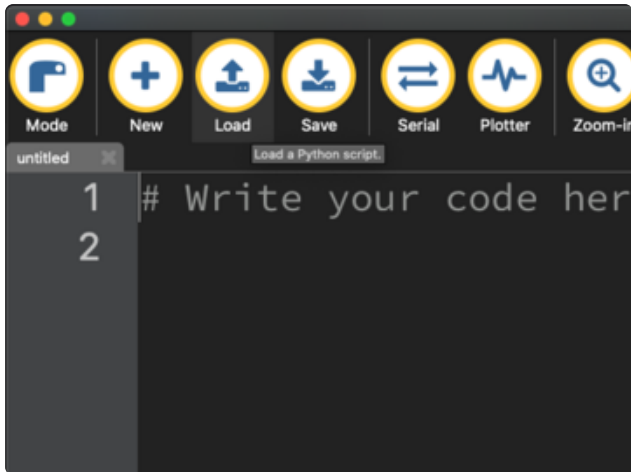

Installing CircuitPython generates a code.py file on your CIRCUITPY drive. To begin your own program, open your editor, and load the code.py file from the CIRCUITPY drive.

If you are using Mu, click the Load button in the button bar, navigate to the CIRCUITPY drive, and choose code.py.

Copy and paste the following code into your editor:

```
import board
import digitalio
import time

led = digitalio.DigitalInOut(board.LED)
led.direction = digitalio.Direction.OUTPUT

while True:
    led.value = True
    time.sleep(0.5)
    led.value = False
    time.sleep(0.5)
```

The KB2040, QT Py and the Trinkeys do not have a built-in little red LED! There is an addressable RGB NeoPixel LED. The above example will NOT work on the KB2040, QT Py or the Trinkeys!

If you're using a KB2040, QT Py or a Trinkey, please download the [NeoPixel blink example \(\)](#).

The NeoPixel blink example uses the onboard NeoPixel, but the time code is the same. You can use the linked NeoPixel Blink example to follow along with this guide page.

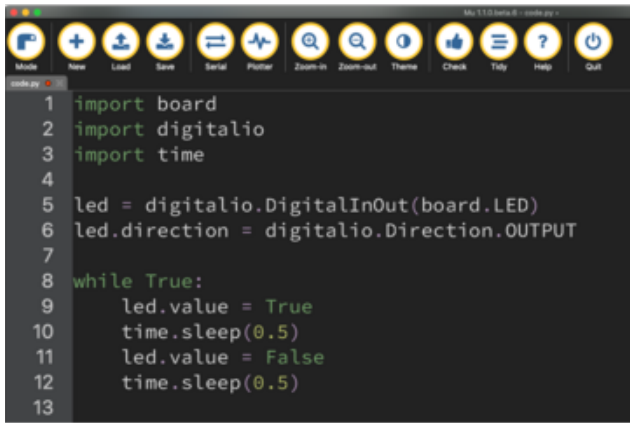

```
1 import board
2 import digitalio
3 import time
4
5 led = digitalio.DigitalInOut(board.LED)
6 led.direction = digitalio.Direction.OUTPUT
7
8 while True:
9     led.value = True
10    time.sleep(0.5)
11    led.value = False
12    time.sleep(0.5)
13
```

It will look like this. Note that under the `while True:` line, the next four lines begin with four spaces to indent them, and they're indented exactly the same amount. All the lines before that have no spaces before the text.

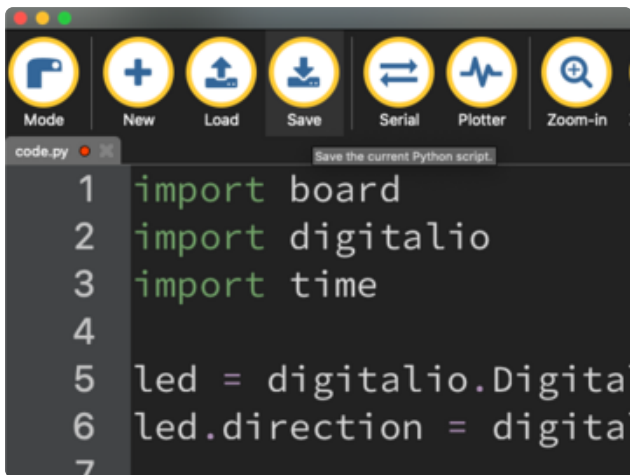

```
1 import board
2 import digitalio
3 import time
4
5 led = digitalio.Digital
6 led.direction = digita
7
```

Save the code.py file on your CIRCUITPY drive.

The little LED should now be blinking. Once per half-second.

Congratulations, you've just run your first CircuitPython program!

On most boards you'll find a tiny red LED.

On the ItsyBitsy nRF52840, you'll find a tiny blue LED.

On QT Py M0, QT Py RP2040, and the Trinkey series, you will find only an RGB NeoPixel LED.

Editing Code

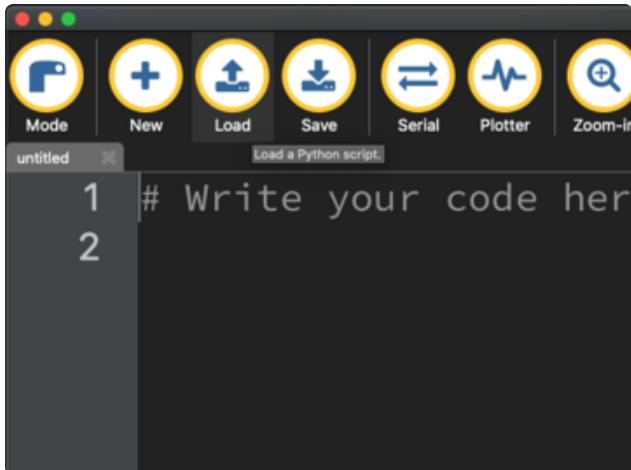

To edit code, open the code.py file on your CIRCUITPY drive into your editor.

Make the desired changes to your code. Save the file. That's it!

Your code changes are run as soon as the file is done saving.

There's one warning before you continue...

Don't click reset or unplug your board!

The CircuitPython code on your board detects when the files are changed or written and will automatically re-start your code. This makes coding very fast because you save, and it re-runs. If you unplug or reset the board before your computer finishes writing the file to your board, you can corrupt the drive. If this happens, you may lose the code you've written, so it's important to backup your code to your computer regularly.

There are a couple of ways to avoid filesystem corruption.

1. Use an editor that writes out the file completely when you save it.

Check out the [Recommended Editors page \(\)](#) for details on different editing options.

If you are dragging a file from your host computer onto the CIRCUITPY drive, you still need to do step 2. Eject or Sync (below) to make sure the file is completely written.

2. Eject or Sync the Drive After Writing

If you are using one of our not-recommended-editors, not all is lost! You can still make it work.

On Windows, you can Eject or Safe Remove the CIRCUITPY drive. It won't actually eject, but it will force the operating system to save your file to disk. On Linux, use the sync command in a terminal to force the write to disk.

You also need to do this if you use Windows Explorer or a Linux graphical file manager to drag a file onto CIRCUITPY.

Oh No I Did Something Wrong and Now The CIRCUITPY Drive Doesn't Show Up!!!

Don't worry! Corrupting the drive isn't the end of the world (or your board!). If this happens, follow the steps found on the [Troubleshooting \(\)](#) page of every board guide to get your board up and running again.

Back to Editing Code...

Now! Let's try editing the program you added to your board. Open your code.py file into your editor. You'll make a simple change. Change the first `0.5` to `0.1`. The code should look like this:

```
import board
import digitalio
import time

led = digitalio.DigitalInOut(board.LED)
led.direction = digitalio.Direction.OUTPUT

while True:
    led.value = True
    time.sleep(0.1)
    led.value = False
    time.sleep(0.5)
```

Leave the rest of the code as-is. Save your file. See what happens to the LED on your board? Something changed! Do you know why?

You don't have to stop there! Let's keep going. Change the second `0.5` to `0.1` so it looks like this:

```
while True:
    led.value = True
    time.sleep(0.1)
    led.value = False
    time.sleep(0.1)
```

Now it blinks really fast! You decreased the both time that the code leaves the LED on and off!

Now try increasing both of the `0.1` to `1`. Your LED will blink much more slowly because you've increased the amount of time that the LED is turned on and off.

Well done! You're doing great! You're ready to start into new examples and edit them to see what happens! These were simple changes, but major changes are done using the same process. Make your desired change, save it, and get the results. That's really all there is to it!

Naming Your Program File

CircuitPython looks for a code file on the board to run. There are four options: `code.txt`, `code.py`, `main.txt` and `main.py`. CircuitPython looks for those files, in that order, and then runs the first one it finds. While `code.py` is the recommended name for your code file, it is important to know that the other options exist. If your program doesn't seem to be updating as you work, make sure you haven't created another code file that's being read instead of the one you're working on.

Exploring Your First CircuitPython Program

First, you'll take a look at the code you're editing.

Here is the original code again:

```
import board
import digitalio
import time

led = digitalio.DigitalInOut(board.LED)
led.direction = digitalio.Direction.OUTPUT

while True:
    led.value = True
    time.sleep(0.5)
    led.value = False
    time.sleep(0.5)
```

Imports & Libraries

Each CircuitPython program you run needs to have a lot of information to work. The reason CircuitPython is so simple to use is that most of that information is stored in other files and works in the background. The files built into CircuitPython are called modules, and the files you load separately are called libraries. Modules are built into CircuitPython. Libraries are stored on your CIRCUITPY drive in a folder called lib.

```
import board
import digitalio
import time
```

The `import` statements tells the board that you're going to use a particular library or module in your code. In this example, you imported three modules: `board`, `digitalio`, and `time`. All three of these modules are built into CircuitPython, so no separate library files are needed. That's one of the things that makes this an excellent first example. You don't need anything extra to make it work!

These three modules each have a purpose. The first one, `board`, gives you access to the hardware on your board. The second, `digitalio`, lets you access that hardware as inputs/outputs. The third, `time`, lets you control the flow of your code in multiple ways, including passing time by 'sleeping'.

Setting Up The LED

The next two lines setup the code to use the LED.

```
led = digitalio.DigitalInOut(board.LED)
led.direction = digitalio.Direction.OUTPUT
```

Your board knows the red LED as `LED`. So, you initialise that pin, and you set it to output. You set `led` to equal the rest of that information so you don't have to type it all out again later in our code.

Loop-de-loops

The third section starts with a `while` statement. `while True:` essentially means, "forever do the following:". `while True:` creates a loop. Code will loop "while" the condition is "true" (vs. false), and as `True` is never False, the code will loop forever. All code that is indented under `while True:` is "inside" the loop.

Inside our loop, you have four items:

```
while True:
    led.value = True
    time.sleep(0.5)
    led.value = False
    time.sleep(0.5)
```

First, you have `led.value = True`. This line tells the LED to turn on. On the next line, you have `time.sleep(0.5)`. This line is telling CircuitPython to pause running code for 0.5 seconds. Since this is between turning the led on and off, the led will be on for 0.5 seconds.

The next two lines are similar. `led.value = False` tells the LED to turn off, and `time.sleep(0.5)` tells CircuitPython to pause for another 0.5 seconds. This occurs between turning the led off and back on so the LED will be off for 0.5 seconds too.

Then the loop will begin again, and continue to do so as long as the code is running!

So, when you changed the first `0.5` to `0.1`, you decreased the amount of time that the code leaves the LED on. So it blinks on really quickly before turning off!

Great job! You've edited code in a CircuitPython program!

What Happens When My Code Finishes Running?

When your code finishes running, CircuitPython resets your microcontroller board to prepare it for the next run of code. That means any set up you did earlier no longer applies, and the pin states are reset.

For example, try reducing the code snippet above by eliminating the loop entirely, and replacing it with `led.value = True`. The LED will flash almost too quickly to see, and turn off. This is because the code finishes running and resets the pin state, and the LED is no longer receiving a signal.

To that end, most CircuitPython programs involve some kind of loop, infinite or otherwise.

What if I Don't Have the Loop?

If you don't have the loop, the code will run to the end and exit. This can lead to some unexpected behavior in simple programs like this since the "exit" also resets the state of the hardware. This is a different behavior than running commands via REPL. So if you are writing a simple program that doesn't seem to work, you may need to add a loop to the end so the program doesn't exit.

The simplest loop would be:

```
while True:  
    pass
```

And remember - you can press CTRL+C to exit the loop.

See also the [Behavior section in the docs \(\)](#).

Connecting to the Serial Console

One of the staples of CircuitPython (and programming in general!) is something called a "print statement". This is a line you include in your code that causes your code to output text. A print statement in CircuitPython (and Python) looks like this:

```
print("Hello, world!")
```

This line in your code.py would result in:

```
Hello, world!
```

However, these print statements need somewhere to display. That's where the serial console comes in!

The serial console receives output from your CircuitPython board sent over USB and displays it so you can see it. This is necessary when you've included a print statement in your code and you'd like to see what you printed. It is also helpful for troubleshooting errors, because your board will send errors and the serial console will display those too.

The serial console requires an editor that has a built in terminal, or a separate

terminal program. A terminal is a program that gives you a text-based interface to perform various tasks.

Are you using Mu?

If so, good news! The serial console is built into Mu and will autodetect your board making using the serial console really really easy.

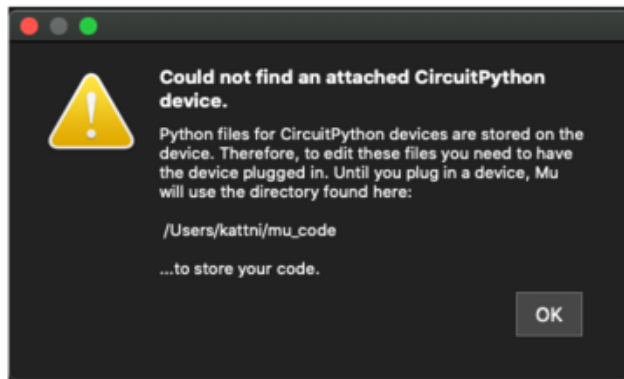

First, make sure your CircuitPython board is plugged in.

If you open Mu without a board plugged in, you may encounter the error seen here, letting you know no CircuitPython board was found and indicating where your code will be stored until you plug in a board.

If you are using Windows 7, make sure you installed the drivers ([link](#)).

Once you've opened Mu with your board plugged in, look for the Serial button in the button bar and click it.

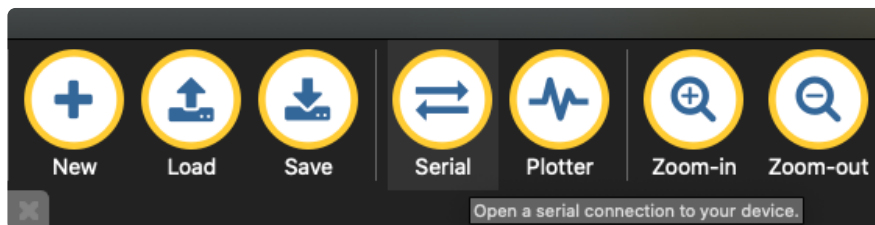

The Mu window will split in two, horizontally, and display the serial console at the bottom.

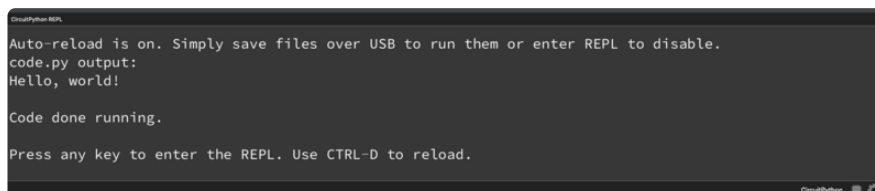

If nothing appears in the serial console, it may mean your code is done running or has no print statements in it. Click into the serial console part of Mu, and press CTRL+D to reload.

Serial Console Issues or Delays on Linux

If you're on Linux, and are seeing multi-second delays connecting to the serial console, or are seeing "AT" and other gibberish when you connect, then the `modemmanager` service might be interfering. Just remove it; it doesn't have much use unless you're still using dial-up modems.

To remove `modemmanager`, type the following command at a shell:

```
sudo apt purge modemmanager
```

Setting Permissions on Linux

On Linux, if you see an error box something like the one below when you press the S erial button, you need to add yourself to a user group to have permission to connect to the serial console.



On Ubuntu and Debian, add yourself to the dialout group by doing:

```
sudo adduser $USER dialout
```

After running the command above, reboot your machine to gain access to the group. On other Linux distributions, the group you need may be different. See the [Advanced Serial Console on Linux \(\)](#) for details on how to add yourself to the right group.

Using Something Else?

If you're not using Mu to edit, are using or if for some reason you are not a fan of its built in serial console, you can run the serial console from a separate program.

Windows requires you to download a terminal program. [Check out the Advanced Serial Console on Windows page for more details. \(\)](#)

MacOS has Terminal built in, though there are other options available for download. [Check the Advanced Serial Console on Mac page for more details. \(\)](#)

Linux has a terminal program built in, though other options are available for download. [Check the Advanced Serial Console on Linux page for more details. \(\)](#)

Once connected, you'll see something like the following.

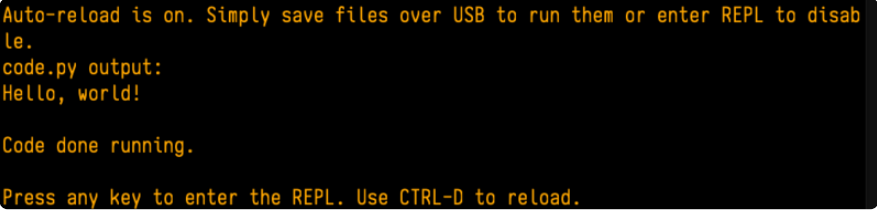

```
Auto-reload is on. Simply save files over USB to run them or enter REPL to disable.  
code.py output:  
Hello, world!  
  
Code done running.  
  
Press any key to enter the REPL. Use CTRL-D to reload.
```

Interacting with the Serial Console

Once you've successfully connected to the serial console, it's time to start using it.

The code you wrote earlier has no output to the serial console. So, you're going to edit it to create some output.

Open your code.py file into your editor, and include a `print` statement. You can print anything you like! Just include your phrase between the quotation marks inside the parentheses. For example:

```
import board
import digitalio
import time

led = digitalio.DigitalInOut(board.LED)
led.direction = digitalio.Direction.OUTPUT

while True:
    print("Hello, CircuitPython!")
    led.value = True
    time.sleep(1)
    led.value = False
    time.sleep(1)
```

Save your file.

Now, let's go take a look at the window with our connection to the serial console.

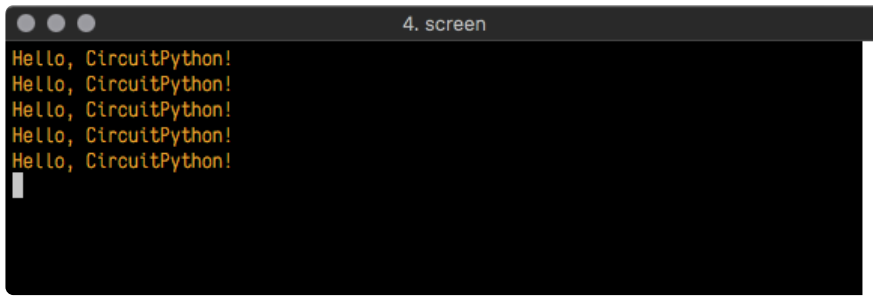

```
Hello, CircuitPython!
Hello, CircuitPython!
Hello, CircuitPython!
Hello, CircuitPython!
Hello, CircuitPython!
```

Excellent! Our print statement is showing up in our console! Try changing the printed text to something else.

```
import board
import digitalio
import time

led = digitalio.DigitalInOut(board.LED)
led.direction = digitalio.Direction.OUTPUT

while True:
    print("Hello back to you!")
    led.value = True
    time.sleep(1)
    led.value = False
    time.sleep(1)
```

Keep your serial console window where you can see it. Save your file. You'll see what the serial console displays when the board reboots. Then you'll see your new change!

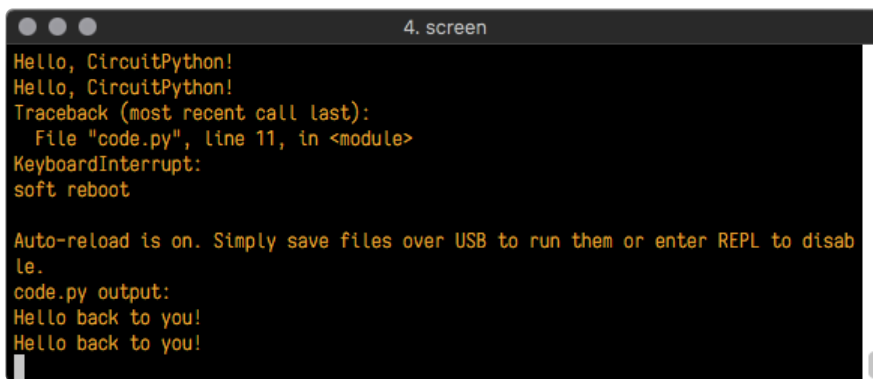

```
Hello, CircuitPython!
Hello, CircuitPython!
Traceback (most recent call last):
  File "code.py", line 11, in <module>
KeyboardInterrupt:
soft reboot

Auto-reload is on. Simply save files over USB to run them or enter REPL to disable.
code.py output:
Hello back to you!
Hello back to you!
```

The **Traceback (most recent call last):** is telling you the last thing your board was doing before you saved your file. This is normal behavior and will happen every time the board resets. This is really handy for troubleshooting. Let's introduce an error so you can see how it is used.

Delete the **e** at the end of **True** from the line **led.value = True** so that it says **led.value = Tru**

```
import board
import digitalio
import time
```



```
led = digitalio.DigitalInOut(board.LED)
led.direction = digitalio.Direction.OUTPUT

while True:
    print("Hello back to you!")
    led.value = Tru
    time.sleep(1)
    led.value = False
    time.sleep(1)
```

Save your file. You will notice that your red LED will stop blinking, and you may have a colored status LED blinking at you. This is because the code is no longer correct and can no longer run properly. You need to fix it!

Usually when you run into errors, it's not because you introduced them on purpose. You may have 200 lines of code, and have no idea where your error could be hiding. This is where the serial console can help. Let's take a look!

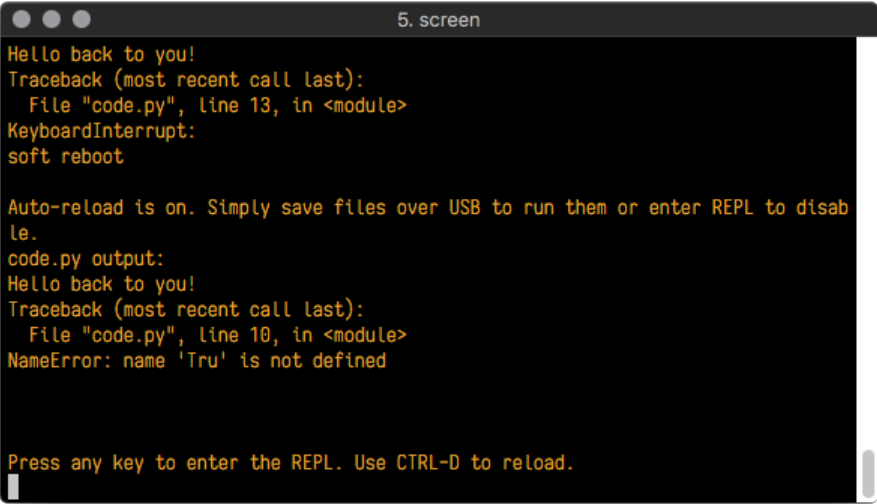
A screenshot of a serial console window titled "5. screen". The window shows the output of a Python program. It starts with "Hello back to you!". Then it shows a "Traceback (most recent call last):" followed by "File 'code.py', line 13, in <module>". Below that, it says "KeyboardInterrupt:" and "soft reboot". Then it says "Auto-reload is on. Simply save files over USB to run them or enter REPL to disable." followed by "code.py output:". The output shows "Hello back to you!". Then another "Traceback (most recent call last):" followed by "File 'code.py', line 10, in <module>" and "NameError: name 'Tru' is not defined". At the bottom, it says "Press any key to enter the REPL. Use CTRL-D to reload.".

```
5. screen
Hello back to you!
Traceback (most recent call last):
  File "code.py", line 13, in <module>
KeyboardInterrupt:
soft reboot

Auto-reload is on. Simply save files over USB to run them or enter REPL to disable.
code.py output:
Hello back to you!
Traceback (most recent call last):
  File "code.py", line 10, in <module>
NameError: name 'Tru' is not defined

Press any key to enter the REPL. Use CTRL-D to reload.
```

The **Traceback (most recent call last):** is telling you that the last thing it was able to run was **line 10** in your code. The next line is your error: **NameError: name 'Tru' is not defined**. This error might not mean a lot to you, but combined with knowing the issue is on line 10, it gives you a great place to start!

Go back to your code, and take a look at line 10. Obviously, you know what the problem is already. But if you didn't, you'd want to look at line 10 and see if you could figure it out. If you're still unsure, try googling the error to get some help. In this case, you know what to look for. You spelled True wrong. Fix the typo and save your file.

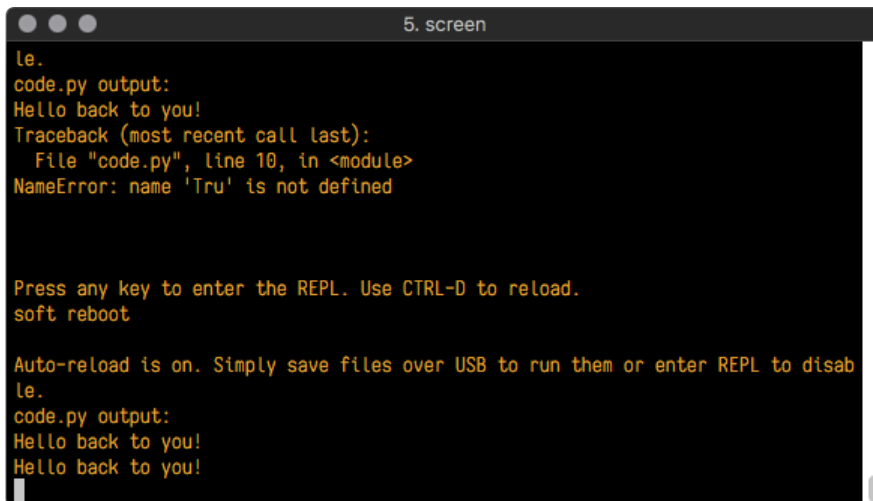

```
le.  
code.py output:  
Hello back to you!  
Traceback (most recent call last):  
  File "code.py", line 10, in <module>  
NameError: name 'Tru' is not defined  
  
Press any key to enter the REPL. Use CTRL-D to reload.  
soft reboot  
  
Auto-reload is on. Simply save files over USB to run them or enter REPL to disable.  
le.  
code.py output:  
Hello back to you!  
Hello back to you!
```

Nice job fixing the error! Your serial console is streaming and your red LED is blinking again.

The serial console will display any output generated by your code. Some sensors, such as a humidity sensor or a thermistor, receive data and you can use print statements to display that information. You can also use print statements for troubleshooting, which is called "print debugging". Essentially, if your code isn't working, and you want to know where it's failing, you can put print statements in various places to see where it stops printing.

The serial console has many uses, and is an amazing tool overall for learning and programming!

The REPL

The other feature of the serial connection is the Read-Evaluate-Print-Loop, or REPL. The REPL allows you to enter individual lines of code and have them run immediately. It's really handy if you're running into trouble with a particular program and can't figure out why. It's interactive so it's great for testing new ideas.

Entering the REPL

To use the REPL, you first need to be connected to the serial console. Once that connection has been established, you'll want to press CTRL+C.

If there is code running, in this case code measuring distance, it will stop and you'll see **Press any key to enter the REPL. Use CTRL-D to reload.** Follow those instructions, and press any key on your keyboard.

The **Traceback (most recent call last):** is telling you the last thing your board was doing before you pressed Ctrl + C and interrupted it. The **KeyboardInterrupt** is you pressing CTRL+C. This information can be handy when troubleshooting, but for now, don't worry about it. Just note that it is expected behavior.

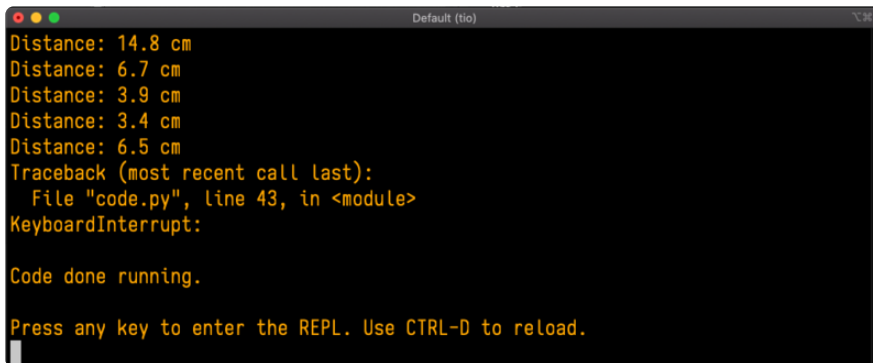

```
Distance: 14.8 cm
Distance: 6.7 cm
Distance: 3.9 cm
Distance: 3.4 cm
Distance: 6.5 cm
Traceback (most recent call last):
  File "code.py", line 43, in <module>
KeyboardInterrupt:

Code done running.

Press any key to enter the REPL. Use CTRL-D to reload.
```

If your code.py file is empty or does not contain a loop, it will show an empty output and **Code done running.** There is no information about what your board was doing before you interrupted it because there is no code running.

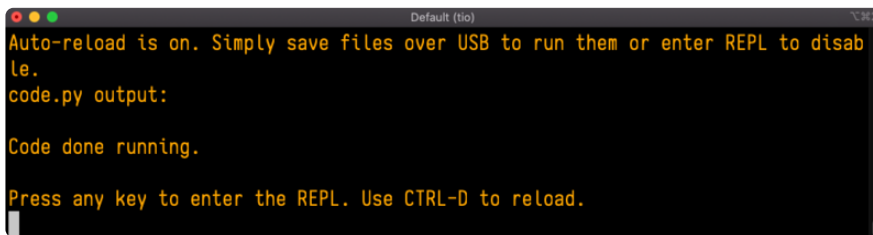

```
Auto-reload is on. Simply save files over USB to run them or enter REPL to disable.
code.py output:

Code done running.

Press any key to enter the REPL. Use CTRL-D to reload.
```

If you have no code.py on your CIRCUITPY drive, you will enter the REPL immediately after pressing CTRL+C. Again, there is no information about what your board was doing before you interrupted it because there is no code running.

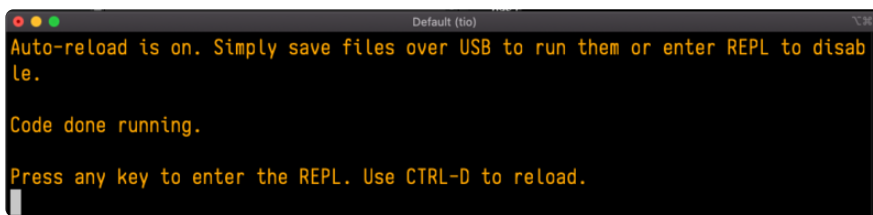

```
Auto-reload is on. Simply save files over USB to run them or enter REPL to disable.

Code done running.

Press any key to enter the REPL. Use CTRL-D to reload.
```

Regardless, once you press a key you'll see a **>>>** prompt welcoming you to the REPL!

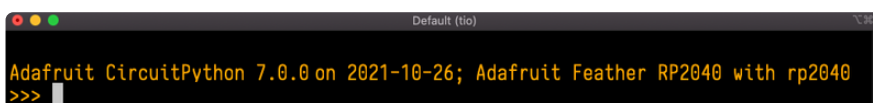

```
Adafruit CircuitPython 7.0.0 on 2021-10-26; Adafruit Feather RP2040 with rp2040
>>> |
```

If you have trouble getting to the **>>>** prompt, try pressing Ctrl + C a few more times.

The first thing you get from the REPL is information about your board.

```
Adafruit CircuitPython 7.0.0 on 2021-10-26; Adafruit Feather RP2040 with rp2040
```

This line tells you the version of CircuitPython you're using and when it was released. Next, it gives you the type of board you're using and the type of microcontroller the board uses. Each part of this may be different for your board depending on the versions you're working with.

This is followed by the CircuitPython prompt.

```
>>>
```

Interacting with the REPL

From this prompt you can run all sorts of commands and code. The first thing you'll do is run `help()`. This will tell you where to start exploring the REPL. To run code in the REPL, type it in next to the REPL prompt.

Type `help()` next to the prompt in the REPL.

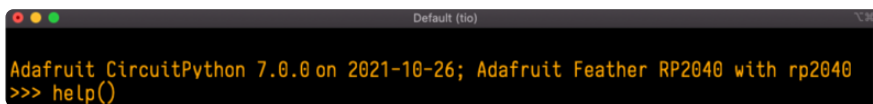

```
Adafruit CircuitPython 7.0.0 on 2021-10-26; Adafruit Feather RP2040 with rp2040
>>> help()
```

Then press enter. You should then see a message.

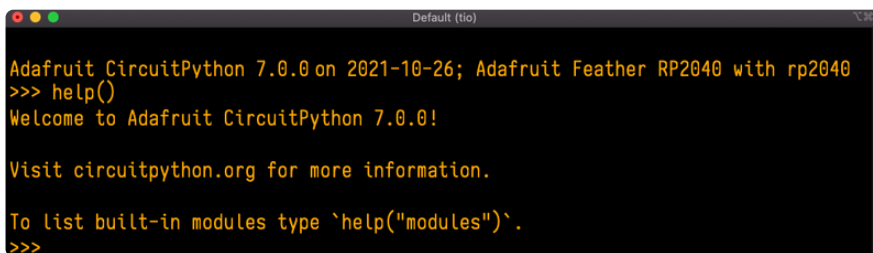

```
Adafruit CircuitPython 7.0.0 on 2021-10-26; Adafruit Feather RP2040 with rp2040
>>> help()
Welcome to Adafruit CircuitPython 7.0.0!

Visit circuitpython.org for more information.

To list built-in modules type `help("modules")`.
>>>
```

First part of the message is another reference to the version of CircuitPython you're using. Second, a URL for the CircuitPython related project guides. Then... wait. What's this? `To list built-in modules type `help("modules")``. Remember the modules you learned about while going through creating code? That's exactly what this is talking about! This is a perfect place to start. Let's take a look!

Type `help("modules")` into the REPL next to the prompt, and press enter.

```
>>> help("modules")
--main--
_bleio      board          micropython    storage
_builtins  builtin         msgpack        struct
adafruit_bus_device  collections    busio          neopixel_write  supervisor
adafruit_pixelbuf  countio       onewireio     synthio
aesio       digitalio     os            sys
alarm       displayio    paralleldisplay  terminalio
analogio    errno        pwmio         touchio
array       fontio       gpio          traceback
atexit      framebufferio  rainbowio     ulab
audiobusio  gc           random        usb_cdc
audiocore   getpass      re            usb_hid
audiomixer  imagecapture  rgbmatrix    usb_midi
audiomp3    io           rotaryio     vectorio
audiopwmio  json        rp2pio       watchdog
binascii    keypad      rtc
bitbangio   math        sdcardio
bitmaptools  microcontroller  sharpdisplay
bitops
Plus any modules on the filesystem
>>>
```

This is a list of all the core modules built into CircuitPython, including `board`. Remember, `board` contains all of the pins on the board that you can use in your code. From the REPL, you are able to see that list!

Type `import board` into the REPL and press enter. It'll go to a new prompt. It might look like nothing happened, but that's not the case! If you recall, the `import` statement simply tells the code to expect to do something with that module. In this case, it's telling the REPL that you plan to do something with that module.

```
>>> import board
>>>
```

Next, type `dir(board)` into the REPL and press enter.

```
>>> dir(board)
['__class__', '__name__', 'A0', 'A1', 'A2', 'A3', 'D0', 'D1', 'D10', 'D11', 'D12', 'D13',
'D24', 'D25', 'D4', 'D5', 'D6', 'D9', 'I2C', 'LED', 'MISO', 'MOSI', 'NEOPIXEL', 'RX', 'SCK',
'SCL', 'SDA', 'SPI', 'TX', 'UART', 'board_id']
>>>
```

This is a list of all of the pins on your board that are available for you to use in your code. Each board's list will differ slightly depending on the number of pins available. Do you see `LED`? That's the pin you used to blink the red LED!

The REPL can also be used to run code. Be aware that any code you enter into the REPL isn't saved anywhere. If you're testing something new that you'd like to keep, make sure you have it saved somewhere on your computer as well!

Every programmer in every programming language starts with a piece of code that says, "Hello, World." You're going to say hello to something else. Type into the REPL:

```
print("Hello, CircuitPython!")
```

Then press enter.

```
>>> print("Hello, CircuitPython")
Hello, CircuitPython
>>>
```

That's all there is to running code in the REPL! Nice job!

You can write single lines of code that run stand-alone. You can also write entire programs into the REPL to test them. Remember that nothing typed into the REPL is saved.

There's a lot the REPL can do for you. It's great for testing new ideas if you want to see if a few new lines of code will work. It's fantastic for troubleshooting code by entering it one line at a time and finding out where it fails. It lets you see what modules are available and explore those modules.

Try typing more into the REPL to see what happens!

Everything typed into the REPL is ephemeral. Once you reload the REPL or return to the serial console, nothing you typed will be retained in any memory space. So be sure to save any desired code you wrote somewhere else, or you'll lose it when you leave the current REPL instance!

Returning to the Serial Console

When you're ready to leave the REPL and return to the serial console, simply press **CTRL+D**. This will reload your board and reenter the serial console. You will restart the program you had running before entering the REPL. In the console window, you'll see any output from the program you had running. And if your program was affecting anything visual on the board, you'll see that start up again as well.

You can return to the REPL at any time!

```
Default (tio)
Auto-reload is on. Simply save files over USB to run them or enter REPL to disable.

Code done running.

Press any key to enter the REPL. Use CTRL-D to reload.
```

CircuitPython Libraries

As CircuitPython development continues and there are new releases, Adafruit will stop supporting older releases. Visit <https://circuitpython.org/downloads> to download the latest version of CircuitPython for your board. You must download the CircuitPython Library Bundle that matches your version of CircuitPython. Please update CircuitPython and then visit <https://circuitpython.org/libraries> to download the latest Library Bundle.

Each CircuitPython program you run needs to have a lot of information to work. The reason CircuitPython is so simple to use is that most of that information is stored in other files and works in the background. These files are called libraries. Some of them are built into CircuitPython. Others are stored on your CIRCUITPY drive in a folder called lib. Part of what makes CircuitPython so great is its ability to store code separately from the firmware itself. Storing code separately from the firmware makes it easier to update both the code you write and the libraries you depend.

Your board may ship with a lib folder already, it's in the base directory of the drive. If not, simply create the folder yourself. When you first install CircuitPython, an empty lib directory will be created for you.

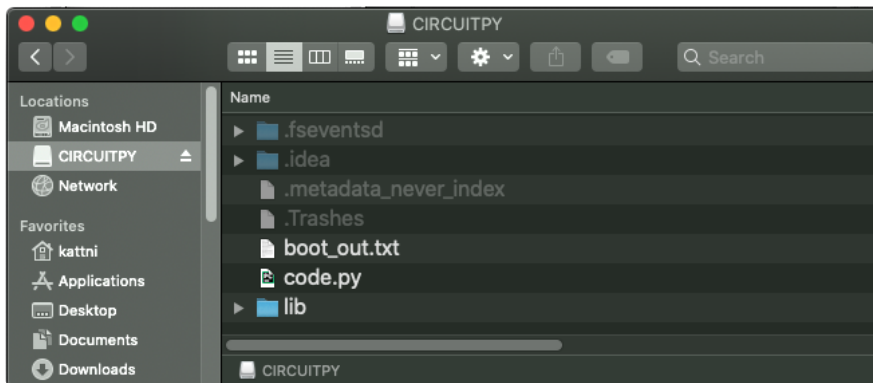

CircuitPython libraries work in the same way as regular Python modules so the [Python docs \(\)](#) are an excellent reference for how it all should work. In Python terms, you can place our library files in the lib directory because it's part of the Python path by default.

One downside of this approach of separate libraries is that they are not built in. To use them, one needs to copy them to the CIRCUITPY drive before they can be used. Fortunately, there is a library bundle.

The bundle and the library releases on GitHub also feature optimized versions of the libraries with the .mpy file extension. These files take less space on the drive and have a smaller memory footprint as they are loaded.

Due to the regular updates and space constraints, Adafruit does not ship boards with the entire bundle. Therefore, you will need to load the libraries you need when you begin working with your board. You can find example code in the guides for your board that depends on external libraries.

Either way, as you start to explore CircuitPython, you'll want to know how to get libraries on board.

The Adafruit Learn Guide Project Bundle

The quickest and easiest way to get going with a project from the Adafruit Learn System is by utilising the Project Bundle. Most guides now have a Download Project Bundle button available at the top of the full code example embed. This button downloads all the necessary files, including images, etc., to get the guide project up and running. Simply click, open the resulting zip, copy over the right files, and you're good to go!

The first step is to find the Download Project Bundle button in the guide you're working on.

The Download Project Bundle button is only available on full demo code embedded from GitHub in a Learn guide. Code snippets will NOT have the button available.

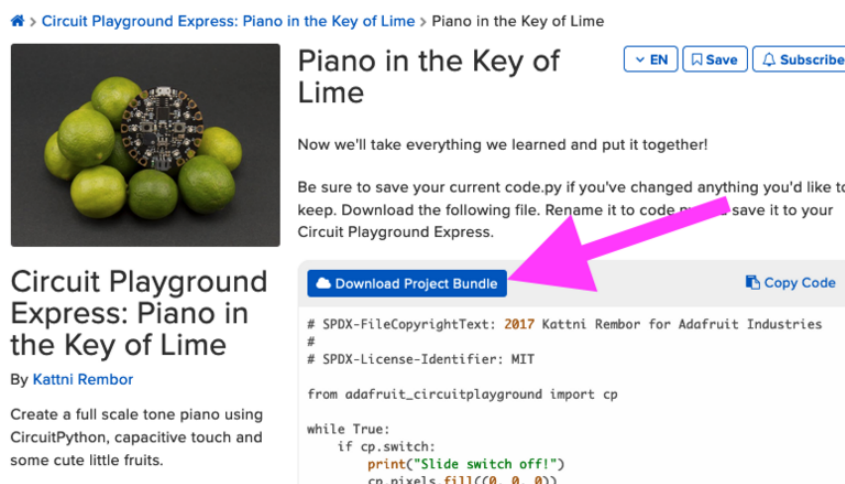

The screenshot shows a web page for a project titled "Piano in the Key of Lime". At the top right, there are buttons for "EN", "Save", and "Subscribe". Below the title, there is a paragraph: "Now we'll take everything we learned and put it together!". Another paragraph follows: "Be sure to save your current code.py if you've changed anything you'd like to keep. Download the following file. Rename it to code.py and save it to your Circuit Playground Express." Below this text, there is a code block with Python code. A pink arrow points to a button labeled "Download Project Bundle" which is located above the code block. To the right of this button is a "Copy Code" button. The code block contains the following text: "# SPDX-FileCopyrightText: 2017 Kattni Rembor for Adafruit Industries", "# SPDX-License-Identifier: MIT", "from adafruit_circuitplayground import cp", "while True:", " if cp.switch:", " print('Slide switch off!')", " cp.pixels.fill((0, 0, 0))".

When you copy the contents of the Project Bundle to your CIRCUITPY drive, it will replace all the existing content! If you don't want to lose anything, ensure you copy your current code to your computer before you copy over the new Project Bundle content!

The Download Project Bundle button downloads a zip file. This zip contains a series of directories, nested within which is the code.py, any applicable assets like images or audio, and the lib/ folder containing all the necessary libraries. The following zip was downloaded from the Piano in the Key of Lime guide.

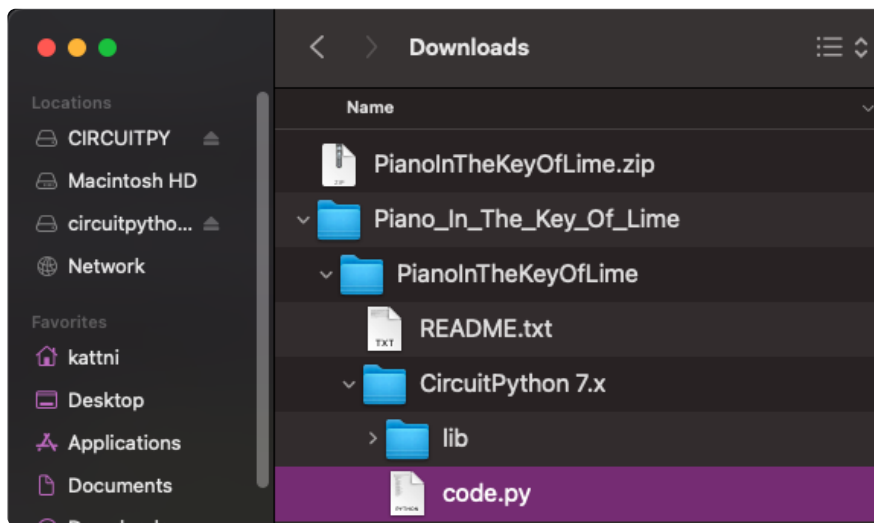

The Piano in the Key of Lime guide was chosen as an example. That guide is specific to Circuit Playground Express, and cannot be used on all boards. Do not expect to download that exact bundle and have it work on your non-CPX microcontroller.

When you open the zip, you'll find some nested directories. Navigate through them until you find what you need. You'll eventually find a directory for your CircuitPython version (in this case, 7.x). In the version directory, you'll find the file and directory you need: code.py and lib/. Once you find the content you need, you can copy it all over to your CIRCUITPY drive, replacing any files already on the drive with the files from the freshly downloaded zip.

In some cases, there will be other files such as audio or images in the same directory as code.py and lib/. Make sure you include all the files when you copy things over!

Once you copy over all the relevant files, the project should begin running! If you find that the project is not running as expected, make sure you've copied ALL of the project files onto your microcontroller board.

That's all there is to using the Project Bundle!

The Adafruit CircuitPython Library Bundle

Adafruit provides CircuitPython libraries for much of the hardware they provide, including sensors, breakouts and more. To eliminate the need for searching for each library individually, the libraries are available together in the Adafruit CircuitPython Library Bundle. The bundle contains all the files needed to use each library.

Downloading the Adafruit CircuitPython Library Bundle

You can download the latest Adafruit CircuitPython Library Bundle release by clicking the button below. The libraries are being constantly updated and improved, so you'll always want to download the latest bundle.

Match up the bundle version with the version of CircuitPython you are running. For example, you would download the 6.x library bundle if you're running any version of CircuitPython 6, or the 7.x library bundle if you're running any version of CircuitPython 7, etc. If you mix libraries with major CircuitPython versions, you will get incompatible mpy errors due to changes in library interfaces possible during major version changes.

Click to visit circuitpython.org for the latest Adafruit CircuitPython Library Bundle

Download the bundle version that matches your CircuitPython firmware version. If you don't know the version, check the version info in `boot_out.txt` file on the CIRCUITPY drive, or the initial prompt in the CircuitPython REPL. For example, if you're running v7.0.0, download the 7.x library bundle.

There's also a py bundle which contains the uncompressed python files, you probably don't want that unless you are doing advanced work on libraries.

The CircuitPython Community Library Bundle

The CircuitPython Community Library Bundle is made up of libraries written and provided by members of the CircuitPython community. These libraries are often written when community members encountered hardware not supported in the Adafruit Bundle, or to support a personal project. The authors all chose to submit these libraries to the Community Bundle make them available to the community.

These libraries are maintained by their authors and are not supported by Adafruit. As you would with any library, if you run into problems, feel free to file an issue on the GitHub repo for the library. Bear in mind, though, that most of these libraries are supported by a single person and you should be patient about receiving a response. Remember, these folks are not paid by Adafruit, and are volunteering their personal time when possible to provide support.

Downloading the CircuitPython Community Library Bundle

You can download the latest CircuitPython Community Library Bundle release by clicking the button below. The libraries are being constantly updated and improved, so you'll always want to download the latest bundle.

[Click for the latest CircuitPython Community Library Bundle release](#)

The link takes you to the latest release of the CircuitPython Community Library Bundle on GitHub. There are multiple versions of the bundle available. Download the bundle version that matches your CircuitPython firmware version. If you don't know the version, check the version info in `boot_out.txt` file on the CIRCUITPY drive, or the initial prompt in the CircuitPython REPL. For example, if you're running v7.0.0, download the 7.x library bundle.

Understanding the Bundle

After downloading the zip, extract its contents. This is usually done by double clicking on the zip. On Mac OSX, it places the file in the same directory as the zip.

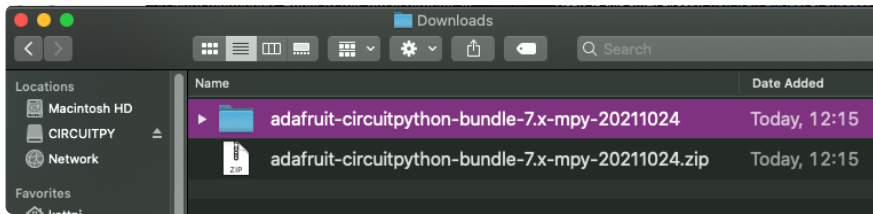

Open the bundle folder. Inside you'll find two information files, and two folders. One folder is the lib bundle, and the other folder is the examples bundle.

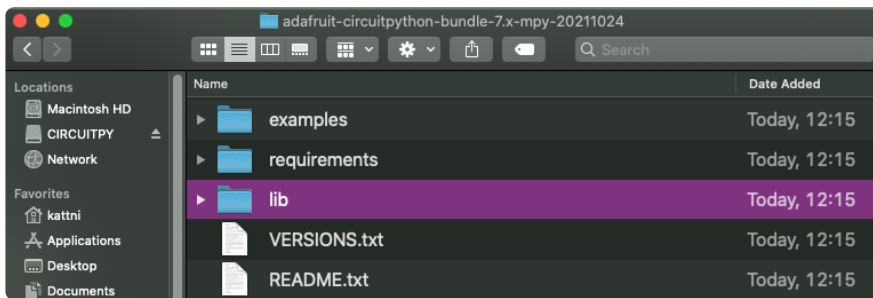

Now open the lib folder. When you open the folder, you'll see a large number of .mpy files, and folders.

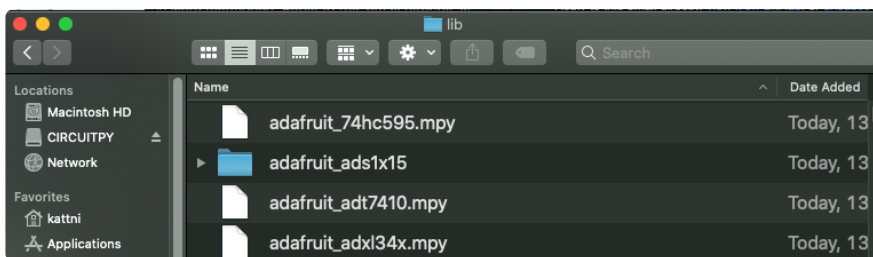

Example Files

All example files from each library are now included in the bundles in an examples directory (as seen above), as well as an examples-only bundle. These are included for two main reasons:

- Allow for quick testing of devices.
- Provide an example base of code, that is easily built upon for individualized purposes.

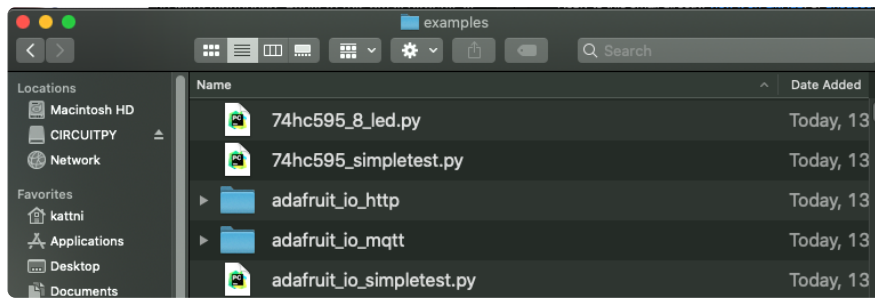

Copying Libraries to Your Board

First open the lib folder on your CIRCUITPY drive. Then, open the lib folder you extracted from the downloaded zip. Inside you'll find a number of folders and .mpy files. Find the library you'd like to use, and copy it to the lib folder on CIRCUITPY.

If the library is a directory with multiple .mpy files in it, be sure to copy the entire folder to CIRCUITPY/lib.

This also applies to example files. Open the examples folder you extracted from the downloaded zip, and copy the applicable file to your CIRCUITPY drive. Then, rename it to code.py to run it.

If a library has multiple .mpy files contained in a folder, be sure to copy the entire folder to CIRCUITPY/lib.

Understanding Which Libraries to Install

You now know how to load libraries on to your CircuitPython-compatible microcontroller board. You may now be wondering, how do you know which libraries you need to install? Unfortunately, it's not always straightforward. Fortunately, there is an obvious place to start, and a relatively simple way to figure out the rest. First up: the best place to start.

When you look at most CircuitPython examples, you'll see they begin with one or more `import` statements. These typically look like the following:

- `import library_or_module`

However, `import` statements can also sometimes look like the following:

- `from library_or_module import name`
- `from library_or_module.subpackage import name`
- `from library_or_module import name as local_name`

They can also have more complicated formats, such as including a `try` / `except` block, etc.

The important thing to know is that an `import` statement will always include the name of the module or library that you're importing.

Therefore, the best place to start is by reading through the `import` statements.

Here is an example import list for you to work with in this section. There is no setup or other code shown here, as the purpose of this section involves only the import list.

```
import time
import board
import neopixel
import adafruit_lis3dh
import usb_hid
from adafruit_hid.consumer_control import ConsumerControl
from adafruit_hid.consumer_control_code import ConsumerControlCode
```

Keep in mind, not all imported items are libraries. Some of them are almost always built-in CircuitPython modules. How do you know the difference? Time to visit the REPL.

In the [Interacting with the REPL section \(\)](#) on [The REPL page \(\)](#) in this guide, the `help("modules")` command is discussed. This command provides a list of all of the built-in modules available in CircuitPython for your board. So, if you connect to the serial console on your board, and enter the REPL, you can run `help("modules")` to see what modules are available for your board. Then, as you read through the `import` statements, you can, for the purposes of figuring out which libraries to load, ignore the statement that import modules.

The following is the list of modules built into CircuitPython for the Feather RP2040. Your list may look similar or be anything down to a significant subset of this list for smaller boards.

```
>>> help("modules")
__main__      board          micropython    storage
_bleio        builtins       msgpack        struct
adafruit_bus_device  collections   busio          neopixel_write  supervisor
adafruit_pixelbuf  countio       onewireio     synthio
aesio          digitalio     os            sys
alarm          displayio    paralledisplay  terminalio
analogio       errno        pulseio       time
array          fontio       pwmio         touchio
atexit         framebufferio  qrio          traceback
audiobusio     gc           rainbowio     ulab
audiocore      getpass      random        usb_cdc
audiomixer     imagecapture  re            usb_hid
audiomp3       io           rgbmatrix    usb_midi
audiopwmio     json         rotaryio     vectorio
binascii       keypad       rp2pio       watchdog
bitbangio     math         rtc
bitmaptools    microcontroller  sdcardio
bitops         sharpdisplay
```

Now that you know what you're looking for, it's time to read through the import statements. The first two, `time` and `board`, are on the modules list above, so they're built-in.

The next one, `neopixel`, is not on the module list. That means it's your first library! So, you would head over to the bundle zip you downloaded, and search for neopixel. There is a `neopixel.mpy` file in the bundle zip. Copy it over to the lib folder on your CIRCUIPY drive. The following one, `adafruit_lis3dh`, is also not on the module list. Follow the same process for `adafruit_lis3dh`, where you'll find `adafruit_lis3dh.mpy`, and copy that over.

The fifth one is `usb_hid`, and it is in the modules list, so it is built in. Often all of the built-in modules come first in the import list, but sometimes they don't! Don't assume that everything after the first library is also a library, and verify each import with the modules list to be sure. Otherwise, you'll search the bundle and come up empty!

The final two imports are not as clear. Remember, when `import` statements are formatted like this, the first thing after the `from` is the library name. In this case, the library name is `adafruit_hid`. A search of the bundle will find an `adafruit_hid` folder. When a library is a folder, you must copy the entire folder and its contents as it is in the bundle to the lib folder on your CIRCUIPY drive. In this case, you would copy the entire `adafruit_hid` folder to your CIRCUIPY/lib folder.

Notice that there are two imports that begin with `adafruit_hid`. Sometimes you will need to import more than one thing from the same library. Regardless of how many times you import the same library, you only need to load the library by copying over the `adafruit_hid` folder once.

That is how you can use your example code to figure out what libraries to load on your CircuitPython-compatible board!

There are cases, however, where libraries require other libraries internally. The internally required library is called a dependency. In the event of library dependencies, the easiest way to figure out what other libraries are required is to connect to the serial console and follow along with the `ImportError` printed there. The following is a very simple example of an `ImportError`, but the concept is the same for any missing library.

Example: `ImportError` Due to Missing Library

If you choose to load libraries as you need them, or you're starting fresh with an existing example, you may end up with code that tries to use a library you haven't yet loaded. This section will demonstrate what happens when you try to utilise a library that you don't have loaded on your board, and cover the steps required to resolve the issue.

This demonstration will only return an error if you do not have the required library loaded into the lib folder on your CIRCUITPY drive.

Let's use a modified version of the Blink example.

```
import board
import time
import simpleio

led = simpleio.DigitalOut(board.LED)

while True:
    led.value = True
    time.sleep(0.5)
    led.value = False
    time.sleep(0.5)
```

Save this file. Nothing happens to your board. Let's check the serial console to see what's going on.

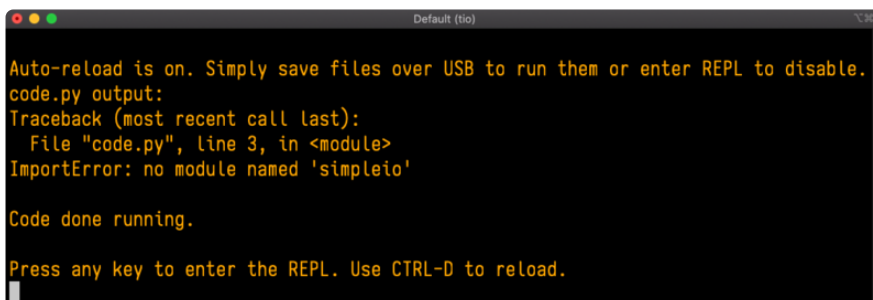
A screenshot of a serial console window titled "Default (tio)". The window has a black background with yellow text. The text shows the output of a Python script: "Auto-reload is on. Simply save files over USB to run them or enter REPL to disable." followed by "code.py output:", "Traceback (most recent call last):", "File \"code.py\", line 3, in <module>", and "ImportError: no module named 'simpleio'". Below this, it says "Code done running." and "Press any key to enter the REPL. Use CTRL-D to reload." The window also shows standard macOS window controls (red, yellow, green buttons) in the top left corner and a cursor icon in the top right corner.

```
Default (tio)
Auto-reload is on. Simply save files over USB to run them or enter REPL to disable.
code.py output:
Traceback (most recent call last):
  File "code.py", line 3, in <module>
ImportError: no module named 'simpleio'

Code done running.

Press any key to enter the REPL. Use CTRL-D to reload.
```

You have an `ImportError`. It says there is `no module named 'simpleio'`. That's the one you just included in your code!

Click the link above to download the correct bundle. Extract the lib folder from the downloaded bundle file. Scroll down to find `simpleio.mpy`. This is the library file you're looking for! Follow the steps above to load an individual library file.

The LED starts blinking again! Let's check the serial console.

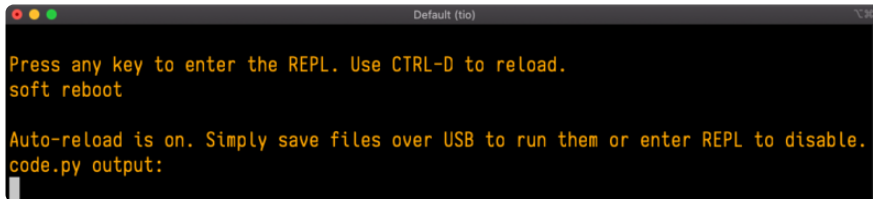

```
Default (tio)
Press any key to enter the REPL. Use CTRL-D to reload.
soft reboot

Auto-reload is on. Simply save files over USB to run them or enter REPL to disable.
code.py output:
```

No errors! Excellent. You've successfully resolved an `ImportError`!

If you run into this error in the future, follow along with the steps above and choose the library that matches the one you're missing.

Library Install on Non-Express Boards

If you have an M0 non-Express board such as Trinket M0, Gemma M0, QT Py M0, or one of the M0 Trinkeys, you'll want to follow the same steps in the example above to install libraries as you need them. Remember, you don't need to wait for an `ImportError` if you know what library you added to your code. Open the library bundle you downloaded, find the library you need, and drag it to the lib folder on your CIRCUITPY drive.

You can still end up running out of space on your M0 non-Express board even if you only load libraries as you need them. There are a number of steps you can use to try to resolve this issue. You'll find suggestions on the [Troubleshooting page](#) ().

Updating CircuitPython Libraries and Examples

Libraries and examples are updated from time to time, and it's important to update the files you have on your CIRCUITPY drive.

To update a single library or example, follow the same steps above. When you drag the library file to your lib folder, it will ask if you want to replace it. Say yes. That's it!

A new library bundle is released every time there's an update to a library. Updates include things like bug fixes and new features. It's important to check in every so often to see if the libraries you're using have been updated.

CircUp CLI Tool

There is a command line interface (CLI) utility called [CircUp \(\)](#) that can be used to easily install and update libraries on your device. Follow the directions on the [install page within the CircUp learn guide \(\)](#). Once you've got it installed you run the command `circup update` in a terminal to interactively update all libraries on the connected CircuitPython device. See the [usage page in the CircUp guide \(\)](#) for a full list of functionality

CircuitPython Documentation

You've learned about the CircuitPython built-in modules and external libraries. You know that you can find the modules in CircuitPython, and the libraries in the Library Bundles. There are guides available that explain the basics of many of the modules and libraries. However, there's sometimes more capabilities than are necessarily showcased in the guides, and often more to learn about a module or library. So, where can you find more detailed information? That's when you want to look at the API documentation.

The entire CircuitPython project comes with extensive documentation available on Read the Docs. This includes both the [CircuitPython core \(\)](#) and the [Adafruit CircuitPython libraries \(\)](#).

CircuitPython Core Documentation

The [CircuitPython core documentation \(\)](#) covers many of the details you might want to know about the CircuitPython core and related topics. It includes API and usage info, a design guide and information about porting CircuitPython to new boards, MicroPython info with relation to CircuitPython, and general information about the project.

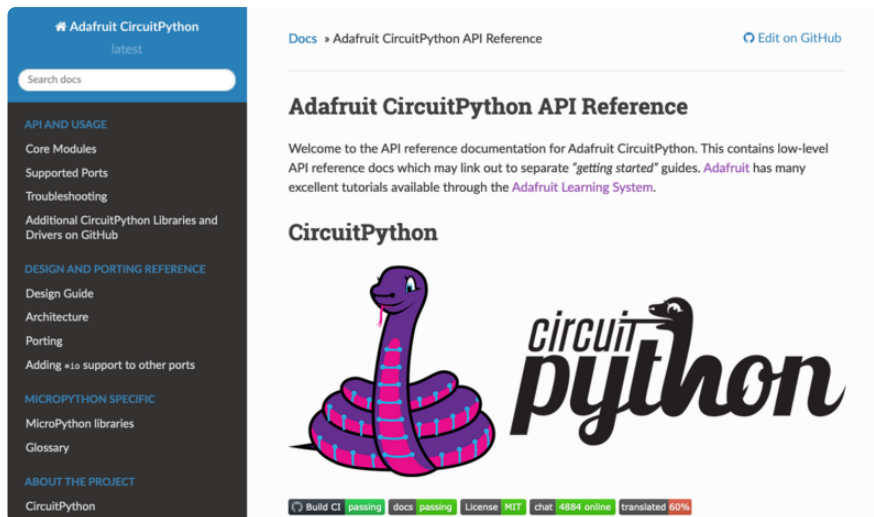

The main page covers the basics including where to download CircuitPython, how to contribute, differences from MicroPython, information about the project structure, and a full table of contents for the rest of the documentation.

The list along the left side leads to more information about specific topics.

The first section is API and Usage. This is where you can find information about how to use individual built-in core modules, such as `time` and `digitalio`, details about the supported ports, suggestions for troubleshooting, and basic info and links to the library bundles. The Core Modules section also includes the Support Matrix, which is a table of which core modules are available on which boards.

The second section is Design and Porting Reference. It includes a design guide, architecture information, details on porting, and adding module support to other ports.

The third section is MicroPython Specific. It includes information on MicroPython and related libraries, and a glossary of terms.

The fourth and final section is About the Project. It includes further information including details on building, testing, and debugging CircuitPython, along with various other useful links including the Adafruit Community Code of Conduct.

Whether you're a seasoned pro or new to electronics and programming, you'll find a wealth of information to help you along your CircuitPython journey in the documentation!

CircuitPython Library Documentation

The Adafruit CircuitPython libraries are documented in a very similar fashion. Each library has its own page on Read the Docs. There is a comprehensive list available [here](#) (). Otherwise, to view the documentation for a specific library, you can visit the GitHub repository for the library, and find the link in the README.

For the purposes of this page, the [LED Animation library](#) () documentation will be featured. There are two links to the documentation in each library GitHub repo. The first one is the docs badge near the top of the README.

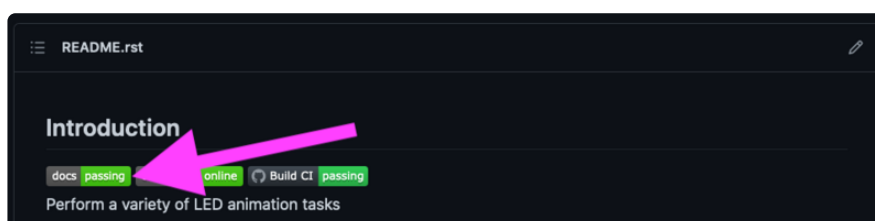

The second place is the Documentation section of the README. Scroll down to find it, and click on Read the Docs to get to the documentation.

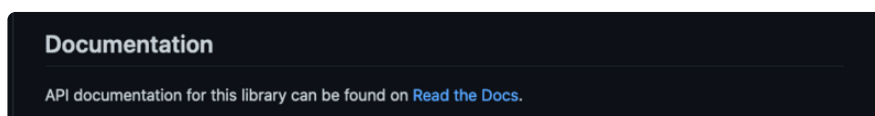

Now that you know how to find it, it's time to take a look at what to expect.

Not all library documentation will look exactly the same, but this will give you some idea of what to expect from library docs.

The Introduction page is generated from the README, so it includes all the same info, such as PyPI installation instructions, a quick demo, and some build details. It also includes a full table of contents for the rest of the documentation (which is not part of the GitHub README). The page should look something like the following.

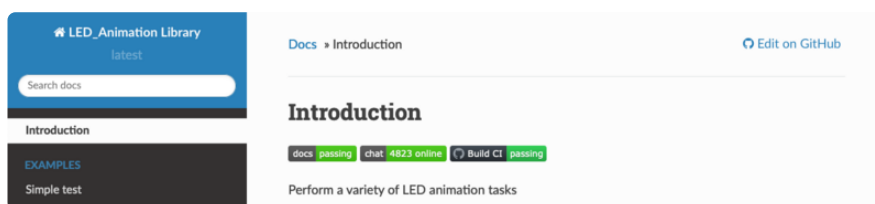

The left side contains links to the rest of the documentation, divided into three separate sections: Examples, API Reference, and Other Links.

Examples

The [Examples section](#) () is a list of library examples. This list contains anywhere from a small selection to the full list of the examples available for the library.

This section will always contain at least one example - the simple test example.



The simple test example is usually a basic example designed to show your setup is working. It may require other libraries to run. Keep in mind, it's simple - it won't showcase a comprehensive use of all the library features.

The LED Animation simple test demonstrates the Blink animation.



In some cases, you'll find a longer list, that may include examples that explore other features in the library. The LED Animation documentation includes a series of examples, all of which are available in the library. These examples include demonstrations of both basic and more complex features. Simply click on the example that interests you to view the associated code.



When there are multiple links in the Examples section, all of the example content is, in actuality, on the same page. Each link after the first is an anchor link to the specified section of the page. Therefore, you can also view all the available examples by scrolling down the page.

You can view the rest of the examples by clicking through the list or scrolling down the page. These examples are fully working code. Which is to say, while they may rely on other libraries as well as the library for which you are viewing the documentation, they should not require modification to otherwise work.

API Reference

The [API Reference section \(\)](#) includes a list of the library functions and classes. The API (Application Programming Interface) of a library is the set of functions and classes the library provides. Essentially, the API defines how your program interfaces with the functions and classes that you call in your code to use the library.

There is always at least one list item included. Libraries for which the code is included in a single Python (.py) file, will only have one item. Libraries for which the code is multiple Python files in a directory (called subpackages) will have multiple items in this list. The LED Animation library has a series of subpackages, and therefore, multiple items in this list.

Click on the first item in the list to begin viewing the API Reference section.



As with the Examples section, all of the API Reference content is on a single page, and the links under API Reference are anchor links to the specified section of the page.

When you click on an item in the API Reference section, you'll find details about the classes and functions in the library. In the case of only one item in this section, all the available functionality of the library will be contained within that first and only subsection. However, in the case of a library that has subpackages, each item will contain the features of the particular subpackage indicated by the link. The documentation will cover all of the available functions of the library, including more complex ones that may not interest you.

The first list item is the animation subpackage. If you scroll down, you'll begin to see the available features of animation. They are listed alphabetically. Each of these things can be called in your code. It includes the name and a description of the specific function you would call, and if any parameters are necessary, lists those with a description as well.

```
class adafruit_led_animation.animation.Animation(pixel_object, speed, color, peers=None, paused=False, name=None)
```

Base class for animations.

`add_cycle_complete_receiver(callback)`

Adds an additional callback when the cycle completes.

Parameters

`callback` - Additional callback to trigger when a cycle completes. The callback is passed the animation object instance.

`after_draw()`

Animation subclasses may implement `after_draw()` to do operations after the main `draw()` is called.

You can view the other subpackages by clicking the link on the left or scrolling down the page. You may be interested in something a little more practical. Here is an example. To use the LED Animation library Comet animation, you would run the following example.

```
# SPDX-FileCopyrightText: 2021 Kattni Rembor for Adafruit Industries
# SPDX-License-Identifier: MIT

"""
This example animates a jade comet that bounces from end to end of the strip.

For QT Py Haxpress and a NeoPixel strip. Update pixel_pin and pixel_num to match
your wiring if
using a different board or form of NeoPixels.

This example will run on SAMD21 (M0) Express boards (such as Circuit Playground
Express or QT Py
Haxpress), but not on SAMD21 non-Express boards (such as QT Py or Trinket).
"""
import board
import neopixel

from adafruit_led_animation.animation.comet import Comet
from adafruit_led_animation.color import JADE
```

```
# Update to match the pin connected to your NeoPixels
pixel_pin = board.A3
# Update to match the number of NeoPixels you have connected
pixel_num = 30

pixels = neopixel.NeoPixel(pixel_pin, pixel_num, brightness=0.5, auto_write=False)
comet = Comet(pixels, speed=0.02, color=JADE, tail_length=10, bounce=True)

while True:
    comet.animate()
```

Note the line where you create the `comet` object. There are a number of items inside the parentheses. In this case, you're provided with a fully working example. But what if you want to change how the comet works? The code alone does not explain what the options mean.

So, in the API Reference documentation list, click the [adafruit_led_animation.animation.comet](#) link and scroll down a bit until you see the following.

```
class adafruit_led_animation.animation.comet.Comet(pixel_object, speed, color, tail_length=0, reverse=False, bounce=False, name=None, ring=False)
```

A comet animation.

Parameters

- `pixel_object` – The initialised LED object.
- `speed (float)` – Animation speed in seconds, e.g. `0.1`.
- `color` – Animation color in `(r, g, b)` tuple, or `0x000000` hex format.
- `tail_length (int)` – The length of the comet. Defaults to 25% of the length of the `pixel_object`. Automatically compensates for a minimum of 2 and a maximum of the length of the `pixel_object`.
- `reverse (bool)` – Animates the comet in the reverse order. Defaults to `False`.
- `bounce (bool)` – Comet will bounce back and forth. Defaults to `True`.
- `ring (bool)` – Ring mode. Defaults to `False`.

Look familiar? It is! This is the documentation for setting up the comet object. It explains what each argument provided in the comet setup in the code meant, as well as the other available features. For example, the code includes `speed=0.02`. The documentation clarifies that this is the "Animation speed in seconds". The code doesn't include `ring`. The documentation indicates this is an available setting that enables "Ring mode".

This type of information is available for any function you would set up in your code. If you need clarification on something, wonder whether there's more options available, or are simply interested in the details involved in the code you're writing, check out the documentation for the CircuitPython libraries!

Other Links

This section is the same for every library. It includes a list of links to external sites, which you can visit for more information about the CircuitPython Project and Adafruit.

That covers the CircuitPython library documentation! When you are ready to go beyond the basic library features covered in a guide, or you're interested in understanding those features better, the library documentation on Read the Docs has you covered!

Recommended Editors

The CircuitPython code on your board detects when the files are changed or written and will automatically re-start your code. This makes coding very fast because you save, and it re-runs.

However, you must wait until the file is done being saved before unplugging or resetting your board! On Windows using some editors this can sometimes take up to 90 seconds, on Linux it can take 30 seconds to complete because the text editor does not save the file completely. Mac OS does not seem to have this delay, which is nice!

This is really important to be aware of. If you unplug or reset the board before your computer finishes writing the file to your board, you can corrupt the drive. If this happens, you may lose the code you've written, so it's important to backup your code to your computer regularly.

To avoid the likelihood of filesystem corruption, use an editor that writes out the file completely when you save it. Check out the list of recommended editors below.

Recommended editors

- [mu \(\)](#) is an editor that safely writes all changes (it's also our recommended editor!)
- [emacs \(\)](#) is also an editor that will [fully write files on save \(\)](#)
- [Sublime Text \(\)](#) safely writes all changes
- [Visual Studio Code \(\)](#) appears to safely write all changes
- gedit on Linux appears to safely write all changes
- [IDLE \(\)](#), in Python 3.8.1 or later, [was fixed \(\)](#) to write all changes immediately
- [Thonny \(\)](#) fully writes files on save

Recommended only with particular settings or add-ons

- [vim \(\)](#) / vi safely writes all changes. But set up vim to not write [swapfiles \(\)](#) (.swp files: temporary records of your edits) to CIRCUITPY. Run vim with `vim -n`, set the `no swapfile` option, or set the `directory` option to write swapfiles elsewhere. Otherwise the swapfile writes trigger restarts of your program.
- The [PyCharm IDE \(\)](#) is safe if "Safe Write" is turned on in Settings->System Settings->Synchronization (true by default).
- If you are using [Atom \(\)](#), install the [fsync-on-save package \(\)](#) or the [language-circuitpython package \(\)](#) so that it will always write out all changes to files on CIRCUITPY.
- [SlickEdit \(\)](#) works only if you [add a macro to flush the disk \(\)](#).

The editors listed below are specifically NOT recommended!

Editors that are NOT recommended

- notepad (the default Windows editor) and Notepad++ can be slow to write, so the editors above are recommended! If you are using notepad, be sure to eject the drive.
- IDLE in Python 3.8.0 or earlier does not force out changes immediately.
- nano (on Linux) does not force out changes.
- geany (on Linux) does not force out changes.
- Anything else - Other editors have not been tested so please use a recommended one!

Advanced Serial Console on Windows

Windows 7 and 8.1

If you're using Windows 7 (or 8 or 8.1), you'll need to install drivers. See the [Windows 7 and 8.1 Drivers page \(\)](#) for details. You will not need to install drivers on Mac, Linux or Windows 10.

You are strongly encouraged to upgrade to Windows 10 if you are still using Windows 7 or Windows 8 or 8.1. Windows 7 has reached end-of-life and no longer receives security updates. A free upgrade to Windows 10 is [still available \(\)](#).

What's the COM?

First, you'll want to find out which serial port your board is using. When you plug your board in to USB on your computer, it connects to a serial port. The port is like a door through which your board can communicate with your computer using USB.

You'll use Windows Device Manager to determine which port the board is using. The easiest way to determine which port the board is using is to first check without the board plugged in. Open Device Manager. Click on Ports (COM & LPT). You should find something already in that list with (COM#) after it where # is a number.

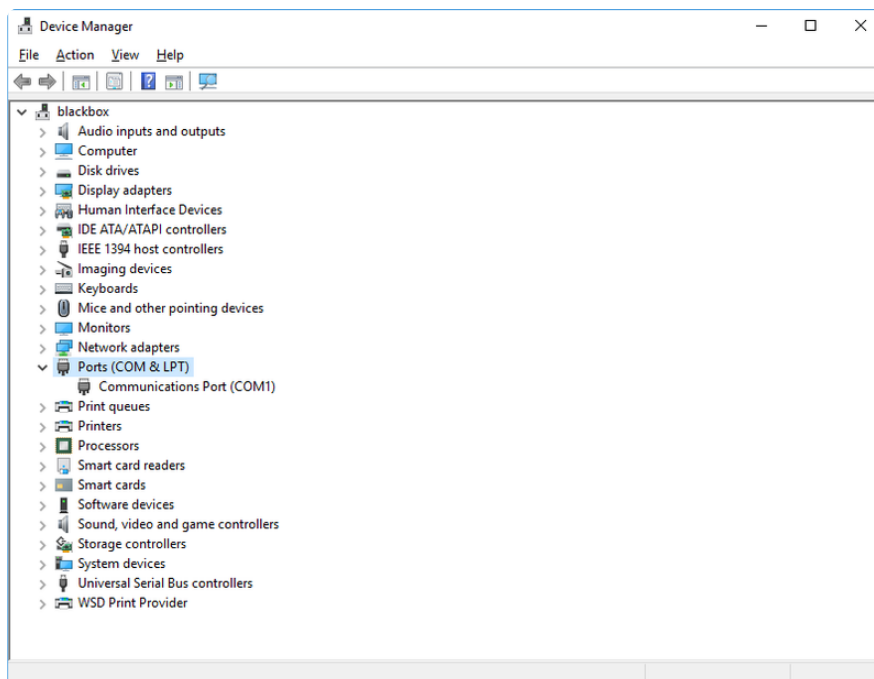

Now plug in your board. The Device Manager list will refresh and a new item will appear under Ports (COM & LPT). You'll find a different (COM#) after this item in the list.

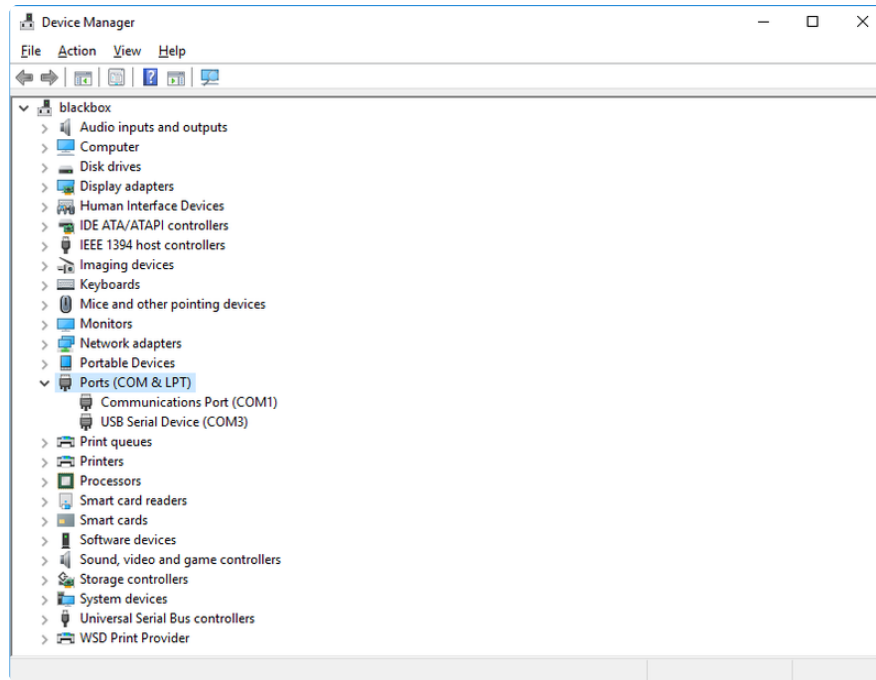

Sometimes the item will refer to the name of the board. Other times it may be called something like USB Serial Device, as seen in the image above. Either way, there is a new (COM#) following the name. This is the port your board is using.

Install Putty

If you're using Windows, you'll need to download a terminal program. You're going to use PuTTY.

The first thing to do is download the [latest version of PuTTY \(\)](#). You'll want to download the Windows installer file. It is most likely that you'll need the 64-bit version. Download the file and install the program on your machine. If you run into issues, you can try downloading the 32-bit version instead. However, the 64-bit version will work on most PCs.

Now you need to open PuTTY.

- Under Connection type: choose the button next to Serial.
- In the box under Serial line, enter the serial port you found that your board is using.
- In the box under Speed, enter 115200. This called the baud rate, which is the speed in bits per second that data is sent over the serial connection. For boards with built in USB it doesn't matter so much but for ESP8266 and other board

with a separate chip, the speed required by the board is 115200 bits per second. So you might as well just use 115200!

If you want to save those settings for later, use the options under Load, save or delete a stored session. Enter a name in the box under Saved Sessions, and click the Save button on the right.

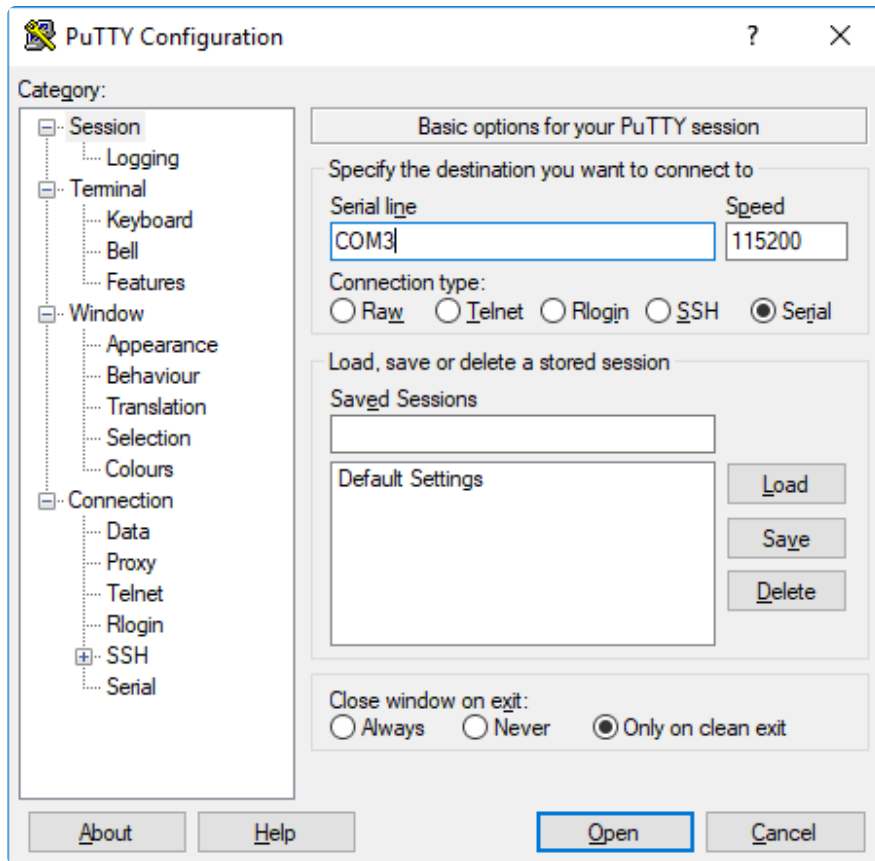

Once your settings are entered, you're ready to connect to the serial console. Click "Open" at the bottom of the window. A new window will open.

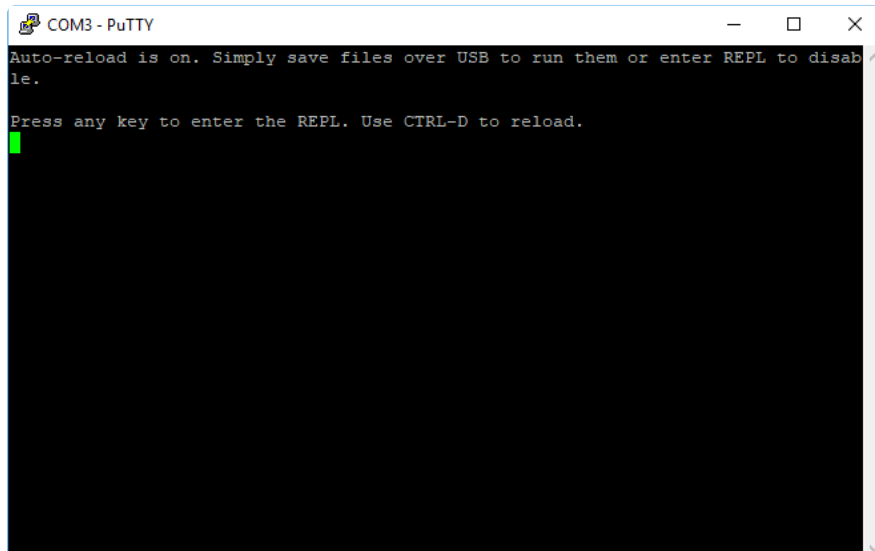

If no code is running, the window will either be blank or will look like the window above. Now you're ready to see the results of your code.

Great job! You've connected to the serial console!

Advanced Serial Console on Mac

Connecting to the serial console on Mac does not require installing any drivers or extra software. You'll use a terminal program to find your board, and `screen` to connect to it. Terminal and `screen` both come installed by default.

What's the Port?

First you'll want to find out which serial port your board is using. When you plug your board in to USB on your computer, it connects to a serial port. The port is like a door through which your board can communicate with your computer using USB.

The easiest way to determine which port the board is using is to first check without the board plugged in. Open Terminal and type the following:

```
ls /dev/tty.*
```

Each serial connection shows up in the `/dev/` directory. It has a name that starts with `tty.`. The command `ls` shows you a list of items in a directory. You can use `*` as a wildcard, to search for files that start with the same letters but end in something different. In this case, you're asking to see all of the listings in `/dev/` that start with `tty.` and end in anything. This will show us the current serial connections.

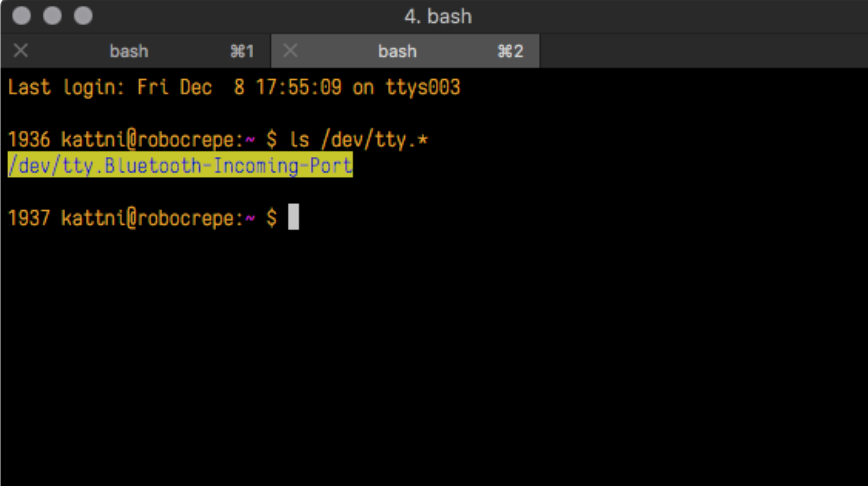

```
4. bash
bash  ⌘1  bash  ⌘2
Last login: Fri Dec  8 17:55:09 on ttys003
1936 kattni@robocrepe:~ $ ls /dev/tty.*
/dev/tty.Bluetooth-Incoming-Port
1937 kattni@robocrepe:~ $
```

Now, plug your board. In Terminal, type:

```
ls /dev/tty.*
```

This will show you the current serial connections, which will now include your board.

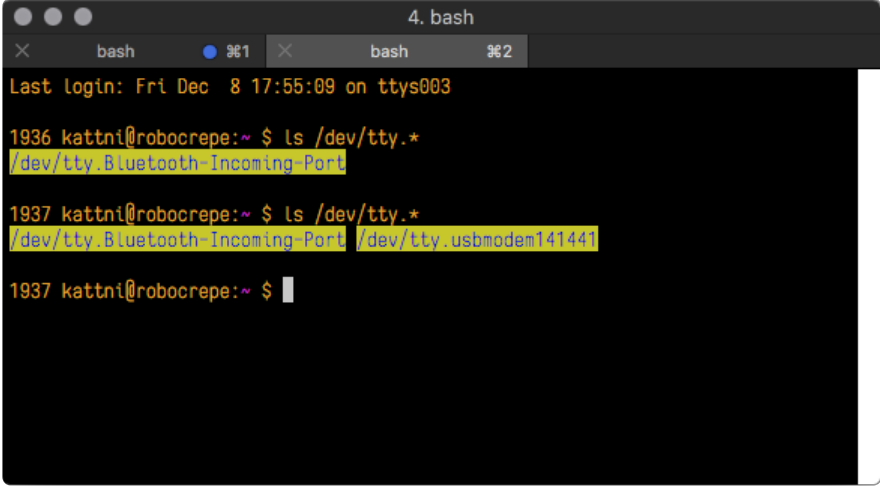
A screenshot of a macOS Terminal window titled "4. bash". The window shows the output of the command "ls /dev/tty.*" being executed. The first execution at 1936 shows only "/dev/tty.Bluetooth-Incoming-Port". The second execution at 1937 shows two entries: "/dev/tty.Bluetooth-Incoming-Port" and "/dev/tty.usbmodem141441". The prompt is "kattni@robocrepe:~" and the cursor is at the end of the second line.

```
4. bash
bash  %1  bash  %2
Last login: Fri Dec 8 17:55:09 on ttys003
1936 kattni@robocrepe:~ $ ls /dev/tty.*
/dev/tty.Bluetooth-Incoming-Port
1937 kattni@robocrepe:~ $ ls /dev/tty.*
/dev/tty.Bluetooth-Incoming-Port /dev/tty.usbmodem141441
1937 kattni@robocrepe:~ $
```

A new listing has appeared called `/dev/tty.usbmodem141441`. The `tty.usbmodem141441` part of this listing is the name the example board is using. Yours will be called something similar.

Using Linux, a new listing has appeared called `/dev/ttyACM0`. The `ttyACM0` part of this listing is the name the example board is using. Yours will be called something similar.

Connect with screen

Now that you know the name your board is using, you're ready connect to the serial console. You're going to use a command called `screen`. The `screen` command is included with MacOS. To connect to the serial console, use Terminal. Type the following command, replacing `board_name` with the name you found your board is using:

```
screen /dev/tty.board_name 115200
```

The first part of this establishes using the `screen` command. The second part tells screen the name of the board you're trying to use. The third part tells screen what baud rate to use for the serial connection. The baud rate is the speed in bits per second that data is sent over the serial connection. In this case, the speed required by the board is 115200 bits per second.

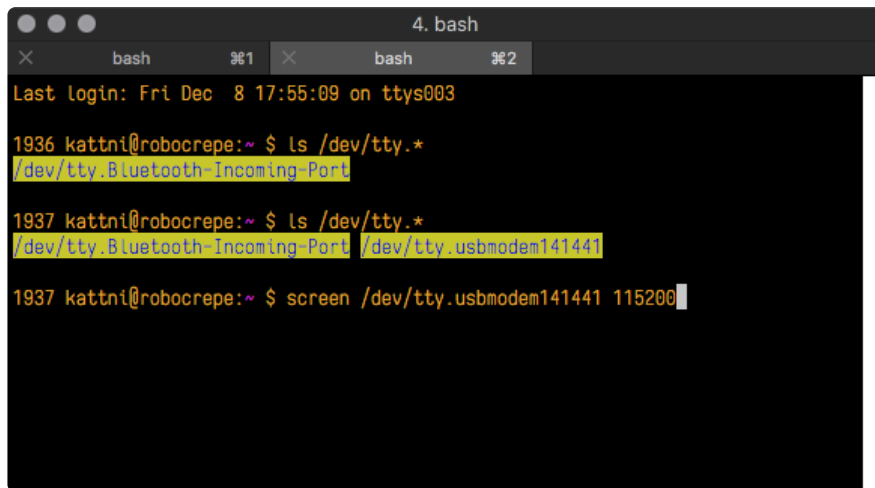
A terminal window titled "4. bash" with two tabs labeled "bash %1" and "bash %2". The terminal shows the following commands and output:

```
Last login: Fri Dec 8 17:55:09 on ttys003
1936 kattni@robocrepe:~ $ ls /dev/tty.*
/dev/tty.Bluetooth-Incoming-Port
1937 kattni@robocrepe:~ $ ls /dev/tty.*
/dev/tty.Bluetooth-Incoming-Port /dev/tty.usbmodem141441
1937 kattni@robocrepe:~ $ screen /dev/tty.usbmodem141441 115200
```

Press enter to run the command. It will open in the same window. If no code is running, the window will be blank. Otherwise, you'll see the output of your code.

Great job! You've connected to the serial console!

Advanced Serial Console on Linux

Connecting to the serial console on Linux does not require installing any drivers, but you may need to install `screen` using your package manager. You'll use a terminal program to find your board, and `screen` to connect to it. There are a variety of terminal programs such as `gnome-terminal` (called Terminal) or `Konsole` on KDE.

The `tio` program works as well to connect to your board, and has the benefit of automatically reconnecting. You would need to install it using your package manager.

What's the Port?

First you'll want to find out which serial port your board is using. When you plug your board in to USB on your computer, it connects to a serial port. The port is like a door through which your board can communicate with your computer using USB.

The easiest way to determine which port the board is using is to first check without the board plugged in. Open your terminal program and type the following:

```
ls /dev/ttyACM*
```

Each serial connection shows up in the `/dev/` directory. It has a name that starts with `ttyACM`. The command `ls` shows you a list of items in a directory. You can use `*` as a wildcard, to search for files that start with the same letters but end in something

different. In this case, You're asking to see all of the listings in /dev/ that start with ttyA CM and end in anything. This will show us the current serial connections.

In the example below, the error is indicating that are no current serial connections starting with ttyACM.

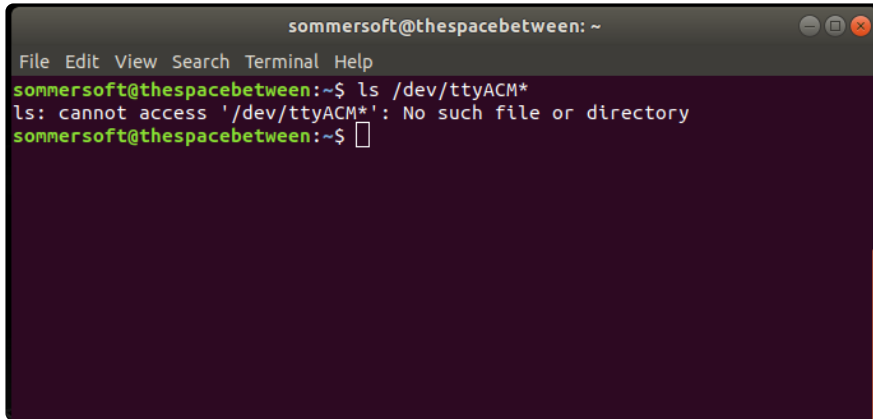

```
sommersoft@thespacebetween: ~  
File Edit View Search Terminal Help  
sommersoft@thespacebetween:~$ ls /dev/ttyACM*  
ls: cannot access '/dev/ttyACM*': No such file or directory  
sommersoft@thespacebetween:~$
```

Now plug in your board. In your terminal program, type:

```
ls /dev/ttyACM*
```

This will show you the current serial connections, which will now include your board.

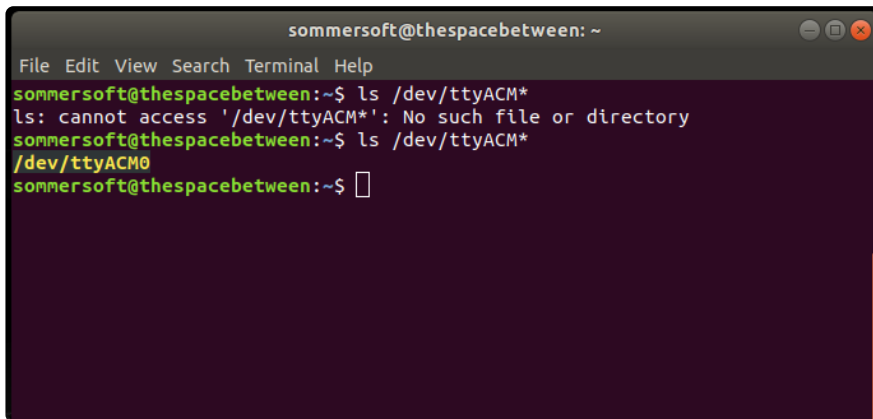

```
sommersoft@thespacebetween: ~  
File Edit View Search Terminal Help  
sommersoft@thespacebetween:~$ ls /dev/ttyACM*  
ls: cannot access '/dev/ttyACM*': No such file or directory  
sommersoft@thespacebetween:~$ ls /dev/ttyACM*  
/dev/ttyACM0  
sommersoft@thespacebetween:~$
```

A new listing has appeared called /dev/ttyACM0. The ttyACM0 part of this listing is the name the example board is using. Yours will be called something similar.

Connect with screen

Now that you know the name your board is using, you're ready connect to the serial console. You'll use a command called `screen`. You may need to install it using the package manager.

To connect to the serial console, use your terminal program. Type the following command, replacing `board_name` with the name you found your board is using:

```
screen /dev/tty.board_name 115200
```

The first part of this establishes using the `screen` command. The second part tells screen the name of the board you're trying to use. The third part tells screen what baud rate to use for the serial connection. The baud rate is the speed in bits per second that data is sent over the serial connection. In this case, the speed required by the board is 115200 bits per second.

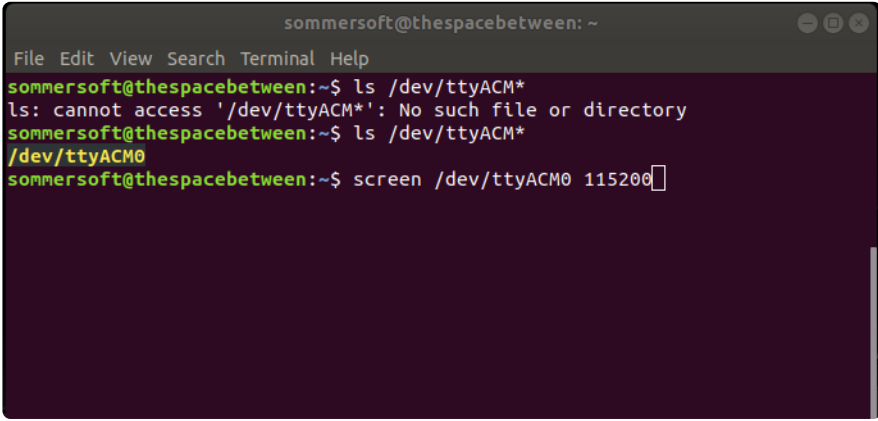
A terminal window titled 'sommersoft@thespacebetween: ~' with a menu bar (File, Edit, View, Search, Terminal, Help). The terminal shows the following commands and output:

```
sommersoft@thespacebetween:~$ ls /dev/ttyACM*
ls: cannot access '/dev/ttyACM*': No such file or directory
sommersoft@thespacebetween:~$ ls /dev/ttyACM*
/dev/ttyACM0
sommersoft@thespacebetween:~$ screen /dev/ttyACM0 115200
```

Press enter to run the command. It will open in the same window. If no code is running, the window will be blank. Otherwise, you'll see the output of your code.

Great job! You've connected to the serial console!

Permissions on Linux

If you try to run `screen` and it doesn't work, then you may be running into an issue with permissions. Linux keeps track of users and groups and what they are allowed to do and not do, like access the hardware associated with the serial connection for running `screen`. So if you see something like this:

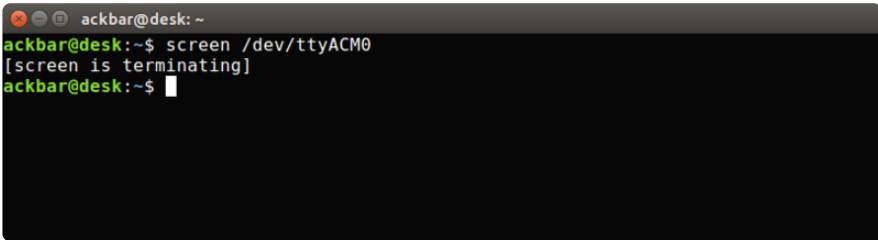
A terminal window titled 'ackbar@desk: ~' showing the following commands and output:

```
ackbar@desk:~$ screen /dev/ttyACM0
[screen is terminating]
ackbar@desk:~$
```

then you may need to grant yourself access. There are generally two ways you can do this. The first is to just run `screen` using the `sudo` command, which temporarily gives you elevated privileges.

```
ackbar@desk: ~
ackbar@desk:~$ screen /dev/ttyACM0
[screen is terminating]
ackbar@desk:~$ sudo screen /dev/ttyACM0
[sudo] password for ackbar: █
```

Once you enter your password, you should be in:

```
ackbar@desk: ~
Auto-reload is on. Simply save files over USB to run them or enter REPL to disable.

Press any key to enter the REPL. Use CTRL-D to reload.

Adafruit CircuitPython 2.1.0 on 2017-10-17; Adafruit Trinket M0 with samd21e18
>>> █
```

The second way is to add yourself to the group associated with the hardware. To figure out what that group is, use the command `ls -l` as shown below. The group name is circled in red.

Then use the command `adduser` to add yourself to that group. You need elevated privileges to do this, so you'll need to use `sudo`. In the example below, the group is `adm` and the user is `ackbar`.

```
ackbar@desk: ~
ackbar@desk:~$ ls -l /dev/ttyACM0
crw-rw---- 1 root adm 166, 0 Dec 21 08:29 /dev/ttyACM0
ackbar@desk:~$ sudo adduser ackbar adm
Adding user `ackbar' to group `adm' ...
Adding user ackbar to group adm
Done.
ackbar@desk:~$ █
```

After you add yourself to the group, you'll need to logout and log back in, or in some cases, reboot your machine. After you log in again, verify that you have been added to the group using the command `groups`. If you are still not in the group, reboot and check again.

```
ackbar@desk: ~
ackbar@desk:~$ groups
ackbar adm sudo
ackbar@desk:~$
```

And now you should be able to run `screen` without using `sudo`.

```
ackbar@desk: ~
ackbar@desk:~$ groups
ackbar adm sudo
ackbar@desk:~$ screen /dev/ttyACM0 115200
```

And you're in:

```
ackbar@desk: ~
Auto-reload is on. Simply save files over USB to run them or enter REPL to disable.

Press any key to enter the REPL. Use CTRL-D to reload.

Adafruit CircuitPython 2.1.0 on 2017-10-17; Adafruit Trinket M0 with samd21e18
>>>
```

The examples above use `screen`, but you can also use other programs, such as `putty` or `picocom`, if you prefer.

Frequently Asked Questions

These are some of the common questions regarding CircuitPython and CircuitPython microcontrollers.

What are some common acronyms to know?

- CP or CPy = [CircuitPython \(\)](#)
 - CPC = [Circuit Playground Classic \(\)](#) (does not run CircuitPython)
 - CPX = [Circuit Playground Express \(\)](#)
 - CPB = [Circuit Playground Bluefruit \(\)](#)
-

Using Older Versions

As CircuitPython development continues and there are new releases, Adafruit will stop supporting older releases. Visit <https://circuitpython.org/downloads> to download the latest version of CircuitPython for your board. You must download the CircuitPython Library Bundle that matches your version of CircuitPython. Please update CircuitPython and then visit <https://circuitpython.org/libraries> to download the latest Library Bundle.

I have to continue using CircuitPython 6.x or earlier. Where can I find compatible libraries?

We are no longer building or supporting the CircuitPython 6.x or earlier library bundles. We highly encourage you to [update CircuitPython to the latest version \(\)](#) and use [the current version of the libraries \(\)](#). However, if for some reason you cannot update, here are the last available library bundles for older versions:

- [2.x bundle \(\)](#)
- [3.x bundle \(\)](#)
- [4.x bundle \(\)](#)
- [5.x bundle \(\)](#)
- [6.x bundle \(\)](#)

Python Arithmetic

Does CircuitPython support floating-point numbers?

All CircuitPython boards support floating point arithmetic, even if the microcontroller chip does not support floating point in hardware. Floating point numbers are stored in 30 bits, with an 8-bit exponent and a 22-bit mantissa. Note that this is two bits less than standard 32-bit single-precision floats. You will get about 5-1/2 digits of decimal precision.

(The broadcom port may provide 64-bit floats in some cases.)

Does CircuitPython support long integers, like regular Python?

Python long integers (integers of arbitrary size) are available on most builds, except those on boards with the smallest available firmware size. On these boards, integers are stored in 31 bits.

Boards without long integer support are mostly SAMD21 ("M0") boards without an external flash chip, such as the Adafruit Gemma M0, Trinket M0, QT Py M0, and the Trinkey series. There are also a number of third-party boards in this category. There are also a few small STM third-party boards without long integer support.

`time.localtime()`, `time.mktime()`, `time.time()`, and `time.monotonic_ns()` are available only on builds with long integers.

Wireless Connectivity

How do I connect to the Internet with CircuitPython?

If you'd like to include WiFi in your project, your best bet is to use a board that is running natively on ESP32 chipsets - those have WiFi built in!

If your development board has an SPI port and at least 4 additional pins, you can check out [this guide \(\)](#) on using AirLift with CircuitPython - extra wiring is required and some boards like the MacroPad or NeoTrellis do not have enough available pins to add the hardware support.

For further project examples, and guides about using AirLift with specific hardware, check out [the Adafruit Learn System \(\)](#).

How do I do BLE (Bluetooth Low Energy) with CircuitPython?

The nRF52840 and nRF52833 boards have the most complete BLE implementation. Your program can act as both a BLE central and peripheral. As a central, you can scan for advertisements, and connect to an advertising board. As a peripheral, you can advertise, and you can create services available to a central. Pairing and bonding are supported.

ESP32-C3 and ESP32-S3 boards currently provide an [incomplete \(\)](#) BLE implementation. Your program can act as a central, and connect to a peripheral.

You can advertise, but you cannot create services. You cannot advertise anonymously. Pairing and bonding are not supported.

The ESP32 could provide a similar implementation, but it is not yet available. Note that the ESP32-S2 does not have Bluetooth capability.

On most other boards with adequate firmware space, [BLE is available for use with AirLift \(\)](#) or other NINA-FW-based co-processors. Some boards have this coprocessor on board, such as the [PyPortal \(\)](#). Currently, this implementation only supports acting as a BLE peripheral. Scanning and connecting as a central are not yet implemented. Bonding and pairing are not supported.

Are there other ways to communicate by radio with CircuitPython?

Check out [Adafruit's RFM boards \(\)](#) for simple radio communication supported by CircuitPython, which can be used over distances of 100m to over a km, depending on the version. The RFM SAMD21 M0 boards can be used, but they were not designed for CircuitPython, and have limited RAM and flash space; using the RFM breakouts or FeatherWings with more capable boards will be easier.

Asyncio and Interrupts

Is there asyncio support in CircuitPython?

There is support for asyncio starting with CircuitPython 7.1.0, on all boards except the smallest SAMD21 builds. Read about using it in the [Cooperative Multitasking in CircuitPython \(\)](#) Guide.

Does CircuitPython support interrupts?

No. CircuitPython does not currently support interrupts - please use asyncio for multitasking / 'threaded' control of your code

Status RGB LED

My RGB NeoPixel/DotStar LED is blinking funny colors - what does it mean?

The status LED can tell you what's going on with your CircuitPython board. [Read more here for what the colors mean! \(\)](#)

Memory Issues

What is a MemoryError?

Memory allocation errors happen when you're trying to store too much on the board. The CircuitPython microcontroller boards have a limited amount of memory available. You can have about 250 lines of code on the M0 Express boards. If you try to `import` too many libraries, a combination of large libraries, or run a program with too many lines of code, your code will fail to run and you will receive a `MemoryError` in the serial console.

What do I do when I encounter a MemoryError?

Try resetting your board. Each time you reset the board, it reallocates the memory. While this is unlikely to resolve your issue, it's a simple step and is worth trying.

Make sure you are using `.mpy` versions of libraries. All of the CircuitPython libraries are available in the bundle in a `.mpy` format which takes up less memory than `.py` format. Be sure that you're using [the latest library bundle \(\)](#) for your version of CircuitPython.

If that does not resolve your issue, try shortening your code. Shorten comments, remove extraneous or unneeded code, or any other clean up you can do to shorten your code. If you're using a lot of functions, you could try moving those into a separate library, creating a `.mpy` of that library, and importing it into your code.

You can turn your entire file into a `.mpy` and `import` that into `code.py`. This means you will be unable to edit your code live on the board, but it can save you space.

Can the order of my `import` statements affect memory?

It can because the memory gets fragmented differently depending on allocation order and the size of objects. Loading `.mpy` files uses less memory so its recommended to do that for files you aren't editing.

How can I create my own .mpy files?

You can make your own .mpy versions of files with `mpy-cross`.

You can download `mpy-cross` for your operating system from [here](#) (). Builds are available for Windows, macOS, x64 Linux, and Raspberry Pi Linux. Choose the latest `mpy-cross` whose version matches the version of CircuitPython you are using.

To make a .mpy file, run `./mpy-cross path/to/yourfile.py` to create a `yourfile.mpy` in the same directory as the original file.

How do I check how much memory I have free?

Run the following to see the number of bytes available for use:

```
import gc
gc.mem_free()
```

Unsupported Hardware

Is ESP8266 or ESP32 supported in CircuitPython? Why not?

We dropped ESP8266 support as of 4.x - For more information please read about it [here](#) ()!

As of CircuitPython 8.x we have started to support ESP32 and ESP32-C3 and have added a WiFi workflow for wireless coding! ()

We also support ESP32-S2 & ESP32-S3, which have native USB.

Does Feather M0 support WINC1500?

No, WINC1500 will not fit into the M0 flash space.

Can AVR's such as ATmega328 or ATmega2560 run CircuitPython?

No.

ESP32-S2 Bugs & Limitations

Nobody likes bugs, but all nontrivial software and hardware has some. The master list of problems is the [Issues list on github \(\)](#).

Adafruit considers CircuitPython for the ESP32-S2 to be beta quality software.

I2C at 100 kHz bus frequency runs slowly

The default I2C bus clock speed is 100 kHz (100000) . At that rate, the ESP32-S2 [will leave 10ms \(\)](#) gaps between I2C transactions. This can slow down your I2C interactions considerably, such as when you are controlling a stepper motor with a PCA9685 controller.

Raising the I2C bus frequency to 125 kHz (125000) or higher fixes this problem. If your I2C peripheral can handle higher frequencies, you can use 400 kHz (400000) or even in some cases 1 MHz (1000000).

Note that `board.I2C()` creates an I2C bus that runs at 100 kHz. The bus frequency cannot be changed.. To create an I2C bus on the default I2C pins that runs at a different frequency, you must use `busio.I2C(board.SCL, board.SDA, frequency=)` .

No DAC-based audio output

Current versions of the ESP-IDF SDK do not have the required APIs for DAC-based audio output. Once a future version of ESP-IDF that adds it, it will be possible to implement DAC-based AudioOut in CircuitPython.

Workaround: PWMOut can create tones and buzzes.

Workaround: I2SOut audio is currently being developed and will work with boards such as the [Adafruit I2S Stereo Decoder - UDA1334A Breakout \(\)](#).

Deep Sleep & Wake-up sources

ESP32-S2 has hardware limitations on what kind of "pin alarms" can wake it. The following combinations are possible:

- EITHER one or two pins that wake from deep sleep when they are pulled LOW

- OR an arbitrary number of pins that wake from deep sleep when they are pulled HIGH, and optionally one pin that wakes from deep sleep when pulled LOW

This means that "wake" buttons should be wired so that pressing them pulls HIGH and a pull DOWN resistor is used with the pin. However, in some hardware designs including the original MagTag, the integrated buttons are pulled LOW when pressed and so only 1 or 2 buttons can be selected to wake the MagTag.

Troubleshooting

From time to time, you will run into issues when working with CircuitPython. Here are a few things you may encounter and how to resolve them.

As CircuitPython development continues and there are new releases, Adafruit will stop supporting older releases. Visit <https://circuitpython.org/downloads> to download the latest version of CircuitPython for your board. You must download the CircuitPython Library Bundle that matches your version of CircuitPython. Please update CircuitPython and then visit <https://circuitpython.org/libraries> to download the latest Library Bundle.

Always Run the Latest Version of CircuitPython and Libraries

As CircuitPython development continues and there are new releases, Adafruit will stop supporting older releases. You need to [update to the latest CircuitPython. \(\)](#).

You need to download the CircuitPython Library Bundle that matches your version of CircuitPython. Please update CircuitPython and then [download the latest bundle \(\)](#).

As new versions of CircuitPython are released, Adafruit will stop providing the previous bundles as automatically created downloads on the Adafruit CircuitPython Library Bundle repo. If you must continue to use an earlier version, you can still download the appropriate version of `mpy-cross` from the particular release of CircuitPython on the CircuitPython repo and create your own compatible .mpy library files. However, it is best to update to the latest for both CircuitPython and the library bundle.

I have to continue using CircuitPython 5.x or earlier.
Where can I find compatible libraries?

Adafruit is no longer building or supporting the CircuitPython 5.x or earlier library bundles. You are highly encouraged to [update CircuitPython to the latest version \(\)](#) and use [the current version of the libraries \(\)](#). However, if for some reason you cannot update, links to the previous bundles are available in the [FAQ \(\)](#).

Bootloader (boardnameBOOT) Drive Not Present

You may have a different board.

Only Adafruit Express boards and the SAMD21 non-Express boards ship with the [UF2 bootloader \(\)](#) installed. The Feather M0 Basic, Feather M0 Adalogger, and similar boards use a regular Arduino-compatible bootloader, which does not show a boardnameBOOT drive.

MakeCode

If you are running a [MakeCode \(\)](#) program on Circuit Playground Express, press the reset button just once to get the CPLAYBOOT drive to show up. Pressing it twice will not work.

MacOS

DriveDx and its accompanying SAT SMART Driver can interfere with seeing the BOOT drive. [See this forum post \(\)](#) for how to fix the problem.

Windows 10

Did you install the Adafruit Windows Drivers package by mistake, or did you upgrade to Windows 10 with the driver package installed? You don't need to install this package on Windows 10 for most Adafruit boards. The old version (v1.5) can interfere with recognizing your device. Go to Settings -> Apps and uninstall all the "Adafruit" driver programs.

Windows 7 or 8.1

To use a CircuitPython-compatible board with Windows 7 or 8.1, you must install a driver. Installation instructions are available [here](#) ().

It is [recommended](#) () that you upgrade to Windows 10 if possible; an upgrade is probably still free for you. Check [here](#) ().

The Windows Drivers installer was last updated in November 2020 (v2.5.0.0) . Windows 7 drivers for CircuitPython boards released since then, including RP2040 boards, are not yet available. The boards work fine on Windows 10. A new release of the drivers is in process.

You should now be done! Test by unplugging and replugging the board. You should see the CIRCUITPY drive, and when you double-click the reset button (single click on Circuit Playground Express running MakeCode), you should see the appropriate boardnameBOOT drive.

Let us know in the [Adafruit support forums](#) () or on the [Adafruit Discord](#) () if this does not work for you!

Windows Explorer Locks Up When Accessing boardnameBOOT Drive

On Windows, several third-party programs that can cause issues. The symptom is that you try to access the boardnameBOOT drive, and Windows or Windows Explorer seems to lock up. These programs are known to cause trouble:

- AIDA64: to fix, stop the program. This problem has been reported to AIDA64. They acquired hardware to test, and released a beta version that fixes the problem. This may have been incorporated into the latest release. Please let us know in the forums if you test this.
- Hard Disk Sentinel
- Kaspersky anti-virus: To fix, you may need to disable Kaspersky completely. Disabling some aspects of Kaspersky does not always solve the problem. This problem has been reported to Kaspersky.
- ESET NOD32 anti-virus: There have been problems with at least version 9.0.386.0, solved by uninstallation.

Copying UF2 to boardnameBOOT Drive Hangs at 0% Copied

On Windows, a Western Digital (WD) utility that comes with their external USB drives can interfere with copying UF2 files to the boardnameBOOT drive. Uninstall that utility to fix the problem.

CIRCUITPY Drive Does Not Appear or Disappears Quickly

Kaspersky anti-virus can block the appearance of the CIRCUITPY drive. There has not yet been settings change discovered that prevents this. Complete uninstallation of Kaspersky fixes the problem.

Norton anti-virus can interfere with CIRCUITPY. A user has reported this problem on Windows 7. The user turned off both Smart Firewall and Auto Protect, and CIRCUITPY then appeared.

Sophos Endpoint security software [can cause CIRCUITPY to disappear \(\)](#) and the BOOT drive to reappear. It is not clear what causes this behavior.

Device Errors or Problems on Windows

Windows can become confused about USB device installations. This is particularly true of Windows 7 and 8.1. It is [recommended \(\)](#) that you upgrade to Windows 10 if possible; an upgrade is probably still free for you: see this [link \(\)](#).

If not, try cleaning up your USB devices. Use [Uwe Sieber's Device Cleanup Tool \(\)](#) (on that page, scroll down to "Device Cleanup Tool"). Download and unzip the tool. Unplug all the boards and other USB devices you want to clean up. Run the tool as Administrator. You will see a listing like this, probably with many more devices. It is listing all the USB devices that are not currently attached.

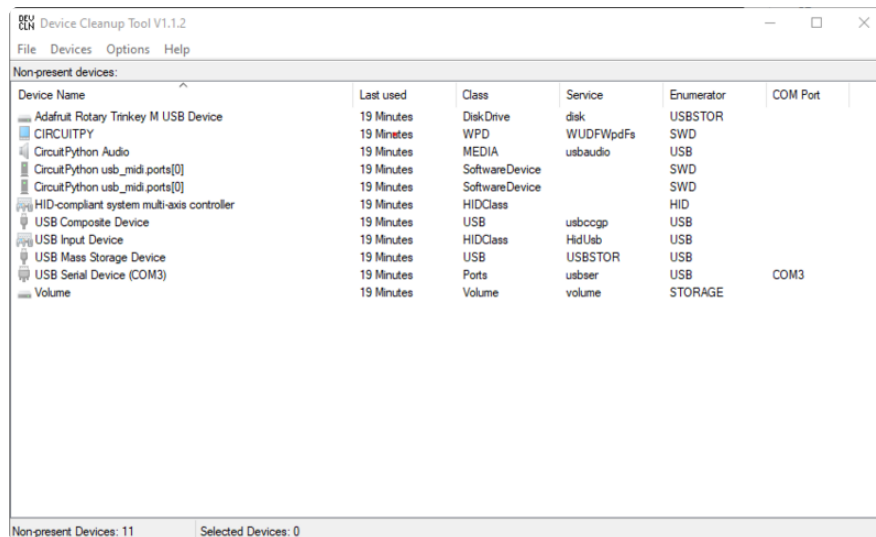

Select all the devices you want to remove, and then press Delete. It is usually safe just to select everything. Any device that is removed will get a fresh install when you plug it in. Using the Device Cleanup Tool also discards all the COM port assignments for the unplugged boards. If you have used many Arduino and CircuitPython boards, you have probably seen higher and higher COM port numbers used, seemingly without end. This will fix that problem.

Serial Console in Mu Not Displaying Anything

There are times when the serial console will accurately not display anything, such as, when no code is currently running, or when code with no serial output is already running before you open the console. However, if you find yourself in a situation where you feel it should be displaying something like an error, consider the following.

Depending on the size of your screen or Mu window, when you open the serial console, the serial console panel may be very small. This can be a problem. A basic CircuitPython error takes 10 lines to display!

```
Auto-reload is on. Simply save files over USB to run them or enter REPL to disable.
code.py output:
Traceback (most recent call last):
  File "code.py", line 7
SyntaxError: invalid syntax
```

Press any key to enter the REPL. Use CTRL-D to reload.

More complex errors take even more lines!

Therefore, if your serial console panel is five lines tall or less, you may only see blank lines or blank lines followed by **Press any key to enter the REPL. Use CTRL-D to reload.** . If this is the case, you need to either mouse over the top of the panel to utilise the option to resize the serial panel, or use the scrollbar on the right side to scroll up and find your message.

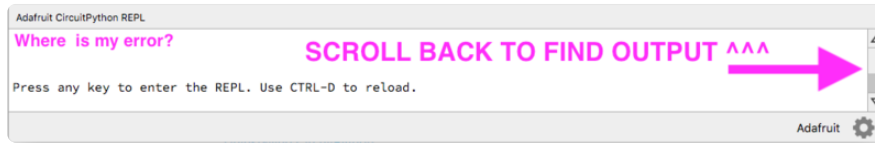

This applies to any kind of serial output whether it be error messages or print statements. So before you start trying to debug your problem on the hardware side, be sure to check that you haven't simply missed the serial messages due to serial output panel height.

code.py Restarts Constantly

CircuitPython will restart code.py if you or your computer writes to something on the CIRCUITPY drive. This feature is called auto-reload, and lets you test a change to your program immediately.

Some utility programs, such as backup, anti-virus, or disk-checking apps, will write to the CIRCUITPY as part of their operation. Sometimes they do this very frequently, causing constant restarts.

Acronis True Image and related Acronis programs on Windows are known to cause this problem. It is possible to prevent this by [disabling the "\(\)Acronis Managed Machine Service Mini" \(\)](#).

If you cannot stop whatever is causing the writes, you can disable auto-reload by putting this code in boot.py or code.py:

```
import supervisor
supervisor.disable_autoreload()
```

CircuitPython RGB Status Light

Nearly all CircuitPython-capable boards have a single NeoPixel or DotStar RGB LED on the board that indicates the status of CircuitPython. A few boards designed before CircuitPython existed, such as the Feather M0 Basic, do not.

Circuit Playground Express and Circuit Playground Bluefruit have multiple RGB LEDs, but do NOT have a status LED. The LEDs are all green when in the bootloader. In versions before 7.0.0, they do NOT indicate any status while running CircuitPython.

CircuitPython 7.0.0 and Later

The status LED blink patterns were changed in CircuitPython 7.0.0 in order to save battery power and simplify the blinks. These blink patterns will occur on single color LEDs when the board does not have any RGB LEDs. Speed and blink count also vary for this reason.

On start up, the LED will blink YELLOW multiple times for 1 second. Pressing the RESET button (or on Espressif, the BOOT button) during this time will restart the board and then enter safe mode. On Bluetooth capable boards, after the yellow blinks, there will be a set of faster blue blinks. Pressing reset during the BLUE blinks will clear Bluetooth information and start the device in discoverable mode, so it can be used with a BLE code editor.

Once started, CircuitPython will blink a pattern every 5 seconds when no user code is running to indicate why the code stopped:

- 1 GREEN blink: Code finished without error.
- 2 RED blinks: Code ended due to an exception. Check the serial console for details.
- 3 YELLOW blinks: CircuitPython is in safe mode. No user code was run. Check the serial console for safe mode reason.

When in the REPL, CircuitPython will set the status LED to WHITE. You can change the LED color from the REPL. The status indicator will not persist on non-NeoPixel or DotStar LEDs.

The CircuitPython Boot Sequence

Version 7.0 and later

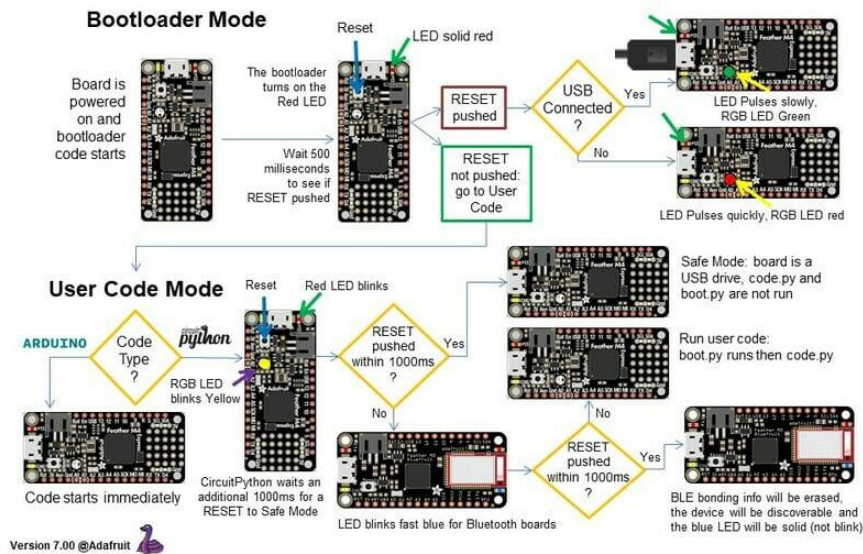

CircuitPython 6.3.0 and earlier

Here's what the colors and blinking mean:

- steady GREEN: code.py (or code.txt, main.py, or main.txt) is running
- pulsing GREEN: code.py (etc.) has finished or does not exist
- steady YELLOW at start up: (4.0.0-alpha.5 and newer) CircuitPython is waiting for a reset to indicate that it should start in safe mode
- pulsing YELLOW: Circuit Python is in safe mode: it crashed and restarted
- steady WHITE: REPL is running
- steady BLUE: boot.py is running

Colors with multiple flashes following indicate a Python exception and then indicate the line number of the error. The color of the first flash indicates the type of error:

- GREEN: IndentationError
- CYAN: SyntaxError
- WHITE: NameError
- ORANGE: OSError
- PURPLE: ValueError
- YELLOW: other error

These are followed by flashes indicating the line number, including place value. WHITE flashes are thousands' place, BLUE are hundreds' place, YELLOW are tens' place,

and CYAN are one's place. So for example, an error on line 32 would flash YELLOW three times and then CYAN two times. Zeroes are indicated by an extra-long dark gap.

The CircuitPython Boot Sequence

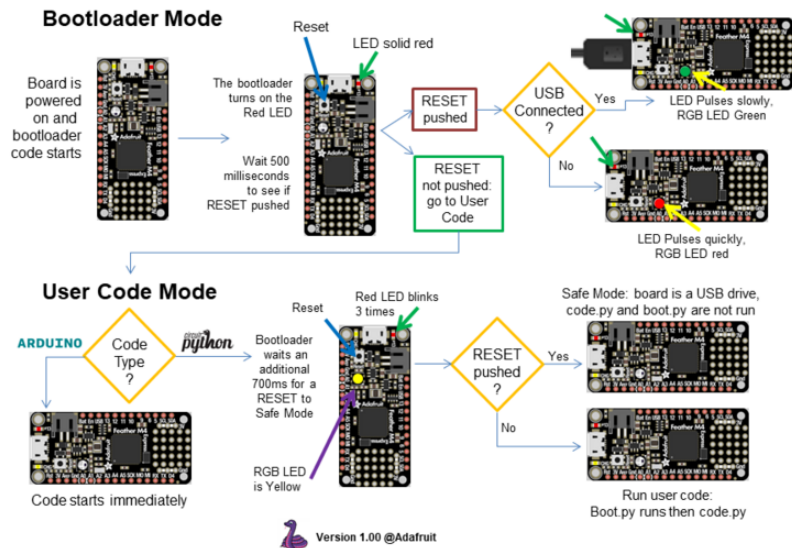

Serial console showing **ValueError: Incompatible .mpy file**

This error occurs when importing a module that is stored as a .mpy binary file that was generated by a different version of CircuitPython than the one its being loaded into. In particular, the mpy binary format changed between CircuitPython versions 6.x and 7.x, 2.x and 3.x, and 1.x and 2.x.

So, for instance, if you upgraded to CircuitPython 7.x from 6.x you'll need to download a newer version of the library that triggered the error on `import`. All libraries are available in the [Adafruit bundle \(\)](#).

CIRCUITPY Drive Issues

You may find that you can no longer save files to your CIRCUITPY drive. You may find that your CIRCUITPY stops showing up in your file explorer, or shows up as NO_NAME. These are indicators that your filesystem has issues. When the CIRCUITPY disk is not safely ejected before being reset by the button or being disconnected from USB, it may corrupt the flash drive. It can happen on Windows, Mac or Linux, though it is more common on Windows.

Be aware, if you have used Arduino to program your board, CircuitPython is no longer able to provide the USB services. You will need to reload CircuitPython to resolve this situation.

The easiest first step is to reload CircuitPython. Double-tap reset on the board so you get a boardnameBOOT drive rather than a CIRCUITPY drive, and copy the latest version of CircuitPython (.uf2) back to the board. This may restore CIRCUITPY functionality.

If reloading CircuitPython does not resolve your issue, the next step is to try putting the board into safe mode.

Safe Mode

Whether you've run into a situation where you can no longer edit your code.py on your CIRCUITPY drive, your board has gotten into a state where CIRCUITPY is read-only, or you have turned off the CIRCUITPY drive altogether, safe mode can help.

Safe mode in CircuitPython does not run any user code on startup, and disables auto-reload. This means a few things. First, safe mode bypasses any code in boot.py (where you can set CIRCUITPY read-only or turn it off completely). Second, it does not run the code in code.py. And finally, it does not automatically soft-reload when data is written to the CIRCUITPY drive.

Therefore, whatever you may have done to put your board in a non-interactive state, safe mode gives you the opportunity to correct it without losing all of the data on the CIRCUITPY drive.

Entering Safe Mode in CircuitPython 7.x and Later

To enter safe mode when using CircuitPython 7.x, plug in your board or hit reset (highlighted in red above). Immediately after the board starts up or resets, it waits 1000ms. On some boards, the onboard status LED will blink yellow during that time. If you press reset during that 1000ms, the board will start up in safe mode. It can be difficult to react to the yellow LED, so you may want to think of it simply as a "slow" double click of the reset button. (Remember, a fast double click of reset enters the bootloader.)

Entering Safe Mode in CircuitPython 6.x

To enter safe mode when using CircuitPython 6.x, plug in your board or hit reset (highlighted in red above). Immediately after the board starts up or resets, it waits 700ms. On some boards, the onboard status LED (highlighted in green above) will turn solid yellow during this time. If you press reset during that 700ms, the board will start up in safe mode. It can be difficult to react to the yellow LED, so you may want to think of it simply as a slow double click of the reset button. (Remember, a fast double click of reset enters the bootloader.)

In Safe Mode

Once you've entered safe mode successfully in CircuitPython 6.x, the LED will pulse yellow.

If you successfully enter safe mode on CircuitPython 7.x, the LED will intermittently blink yellow three times.

If you connect to the serial console, you'll find the following message.

```
Auto-reload is off.  
Running in safe mode! Not running saved code.  
  
CircuitPython is in safe mode because you pressed the reset button during boot.  
Press again to exit safe mode.  
  
Press any key to enter the REPL. Use CTRL-D to reload.
```

You can now edit the contents of the CIRCUITPY drive. Remember, your code will not run until you press the reset button, or unplug and plug in your board, to get out of safe mode.

At this point, you'll want to remove any user code in code.py and, if present, the boot.py file from CIRCUITPY. Once removed, tap the reset button, or unplug and plug in your board, to restart CircuitPython. This will restart the board and may resolve your drive issues. If resolved, you can begin coding again as usual.

If safe mode does not resolve your issue, the board must be completely erased and CircuitPython must be reloaded onto the board.

You WILL lose everything on the board when you complete the following steps. If possible, make a copy of your code before continuing.

To erase CIRCUITPY: `storage.erase_filesystem()`

CircuitPython includes a built-in function to erase and reformat the filesystem. If you have a version of CircuitPython older than 2.3.0 on your board, you can [update to the newest version \(\)](#) to do this.

1. [Connect to the CircuitPython REPL \(\)](#) using Mu or a terminal program.
2. Type the following into the REPL:

```
>>> import storage
>>> storage.erase_filesystem()
```

CIRCUITPY will be erased and reformatted, and your board will restart. That's it!

Erase CIRCUITPY Without Access to the REPL

If you can't access the REPL, or you're running a version of CircuitPython previous to 2.3.0 and you don't want to upgrade, there are options available for some specific boards.

The options listed below are considered to be the "old way" of erasing your board. The method shown above using the REPL is highly recommended as the best method for erasing your board.

If at all possible, it is recommended to use the REPL to erase your CIRCUITPY drive. The REPL method is explained above.

For the specific boards listed below:

If the board you are trying to erase is listed below, follow the steps to use the file to erase your board.

1. Download the correct erase file:

Circuit Playground Express

Feather M0 Express

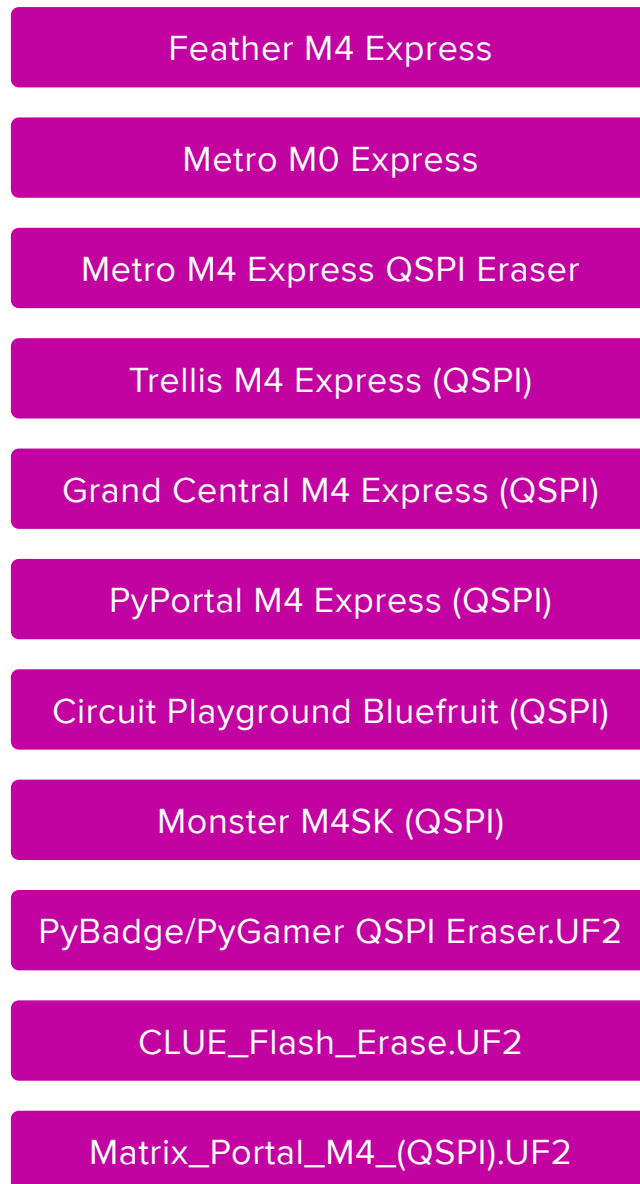

2. Double-click the reset button on the board to bring up the boardnameBOOT drive.

3. Drag the erase .uf2 file to the boardnameBOOT drive.

4. The status LED will turn yellow or blue, indicating the erase has started.

5. After approximately 15 seconds, the status LED will light up green. On the NeoTrellis M4 this is the first NeoPixel on the grid

6. Double-click the reset button on the board to bring up the boardnameBOOT drive.

7. [Drag the appropriate latest release of CircuitPython \(\)](#) .uf2 file to the boardnameBOOT drive.

It should reboot automatically and you should see CIRCUITPY in your file explorer again.

If the LED flashes red during step 5, it means the erase has failed. Repeat the steps starting with 2.

[If you haven't already downloaded the latest release of CircuitPython for your board, check out the installation page \(\)](#). You'll also need to load your code and reinstall your libraries!

For SAMD21 non-Express boards that have a UF2 bootloader:

Any SAMD21-based microcontroller that does not have external flash available is considered a SAMD21 non-Express board. Non-Express boards that have a UF2 bootloader include Trinket M0, GEMMA M0, QT Py M0, and the SAMD21-based Trinkey boards.

If you are trying to erase a SAMD21 non-Express board, follow these steps to erase your board.

1. Download the erase file:

SAMD21 non-Express Boards

2. Double-click the reset button on the board to bring up the boardnameBOOT drive.
3. Drag the erase .uf2 file to the boardnameBOOT drive.
4. The boot LED will start flashing again, and the boardnameBOOT drive will reappear.
5. [Drag the appropriate latest release CircuitPython \(\)](#) .uf2 file to the boardnameBOOT drive.

It should reboot automatically and you should see CIRCUITPY in your file explorer again.

[If you haven't already downloaded the latest release of CircuitPython for your board, check out the installation page \(\)](#) You'll also need to load your code and reinstall your libraries!

For SAMD21 non-Express boards that do not have a UF2 bootloader:

Any SAMD21-based microcontroller that does not have external flash available is considered a SAMD21 non-Express board. Non-Express boards that do not have a UF2 bootloader include the Feather M0 Basic Proto, Feather Adalogger, or the Arduino Zero.

If you are trying to erase a non-Express board that does not have a UF2 bootloader, [follow these directions to reload CircuitPython using `bossac` \(\)](#), which will erase and re-create CIRCUITPY.

Running Out of File Space on SAMD21 Non-Express Boards

Any SAMD21-based microcontroller that does not have external flash available is considered a SAMD21 non-Express board. This includes boards like the Trinket M0, GEMMA M0, QT Py M0, and the SAMD21-based Trinky boards.

The file system on the board is very tiny. (Smaller than an ancient floppy disk.) So, it's likely you'll run out of space but don't panic! There are a number of ways to free up space.

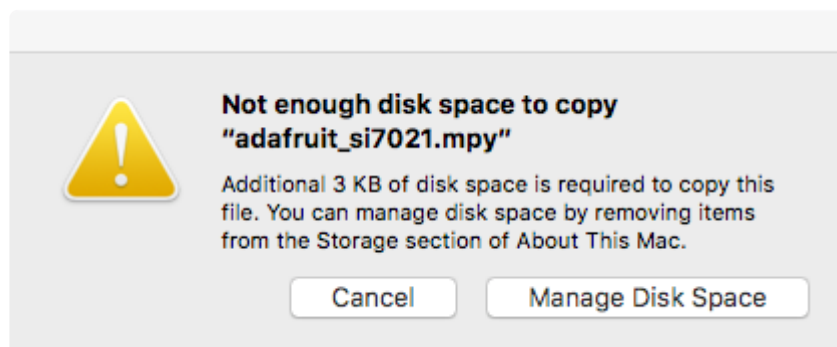

Delete something!

The simplest way of freeing up space is to delete files from the drive. Perhaps there are libraries in the lib folder that you aren't using anymore or test code that isn't in use. Don't delete the lib folder completely, though, just remove what you don't need.

The board ships with the Windows 7 serial driver too! Feel free to delete that if you don't need it or have already installed it. It's ~12KiB or so.

Use tabs

One unique feature of Python is that the indentation of code matters. Usually the recommendation is to indent code with four spaces for every indent. In general, that is recommended too. However, one trick to storing more human-readable code is to use a single tab character for indentation. This approach uses 1/4 of the space for indentation and can be significant when you're counting bytes.

On MacOS?

MacOS loves to generate hidden files. Luckily you can disable some of the extra hidden files that macOS adds by running a few commands to disable search indexing and create zero byte placeholders. Follow the steps below to maximize the amount of space available on macOS.

Prevent & Remove MacOS Hidden Files

First find the volume name for your board. With the board plugged in run this command in a terminal to list all the volumes:

```
ls -l /Volumes
```

Look for a volume with a name like CIRCUITPY (the default for CircuitPython). The full path to the volume is the /Volumes/CIRCUITPY path.

Now follow the [steps from this question \(\)](#) to run these terminal commands that stop hidden files from being created on the board:

```
mdutil -i off /Volumes/CIRCUITPY
cd /Volumes/CIRCUITPY
rm -rf .{,_.}{fseventsd,Spotlight-V*,Trashes}
mkdir .fseventsd
touch .fseventsd/no_log .metadata_never_index .Trashes
cd -
```

Replace /Volumes/CIRCUITPY in the commands above with the full path to your board's volume if it's different. At this point all the hidden files should be cleared from the board and some hidden files will be prevented from being created.

Alternatively, with CircuitPython 4.x and above, the special files and folders mentioned above will be created automatically if you erase and reformat the filesystem. WARNING: Save your files first! Do this in the REPL:

```
>>> import storage
>>> storage.erase_filesystem()
```

However there are still some cases where hidden files will be created by MacOS. In particular if you copy a file that was downloaded from the internet it will have special metadata that MacOS stores as a hidden file. Luckily you can run a copy command from the terminal to copy files without this hidden metadata file. See the steps below.

Copy Files on MacOS Without Creating Hidden Files

Once you've disabled and removed hidden files with the above commands on macOS you need to be careful to copy files to the board with a special command that prevents future hidden files from being created. Unfortunately you cannot use drag and drop copy in Finder because it will still create these hidden extended attribute files in some cases (for files downloaded from the internet, like Adafruit's modules).

To copy a file or folder use the `-X` option for the `cp` command in a terminal. For example to copy a `file_name.mpy` file to the board use a command like:

```
cp -X file_name.mpy /Volumes/CIRCUITPY
```

(Replace `file_name.mpy` with the name of the file you want to copy.)

Or to copy a folder and all of the files and folders contained within, use a command like:

```
cp -rX folder_to_copy /Volumes/CIRCUITPY
```

If you are copying to the `lib` folder, or another folder, make sure it exists before copying.

```
# if lib does not exist, you'll create a file named lib !
cp -X file_name.mpy /Volumes/CIRCUITPY/lib
# This is safer, and will complain if a lib folder does not exist.
cp -X file_name.mpy /Volumes/CIRCUITPY/lib/
```

Other MacOS Space-Saving Tips

If you'd like to see the amount of space used on the drive and manually delete hidden files here's how to do so. First, move into the Volumes/ directory with `cd /Volumes/`, and then list the amount of space used on the CIRCUITPY drive with the `df` command.

```
Default (-bash)
Last login: Thu Oct 28 17:19:15 on ttys008

7039 kattni@robocrepe:~ $ cd /Volumes/

7040 kattni@robocrepe:Volumes $ df -h CIRCUITPY/
Filesystem      Size  Used Avail Capacity  iused ifree %used  Mounted on
/dev/disk2s1    47Ki  46Ki  1.0Ki   98%    512     0 100%  /Volumes/CIRCUITPY

7041 kattni@robocrepe:Volumes $
```

That's not very much space left! The next step is to show a list of the files currently on the CIRCUITPY drive, including the hidden files, using the `ls` command. You cannot use Finder to do this, you must do it via command line!

```
7041 kattni@robocrepe:Volumes $ ls -a CIRCUITPY/
.
..
.fseventsd
.lib
.Trashes
.idea
.original_code.py
.metadata_never_index
.trinket_code.py
boot_out.txt
code.py
original_code.py
trinket_code.py

7042 kattni@robocrepe:Volumes $
```

There are a few of the hidden files that MacOS loves to generate, all of which begin with a `._` before the file name. Remove the `._` files using the `rm` command. You can remove them all once by running `rm CIRCUITPY/._*`. The `*` acts as a wildcard to apply the command to everything that begins with `._` at the same time.

```
7042 kattni@robocrepe:Volumes $ rm CIRCUITPY/._*

7043 kattni@robocrepe:Volumes $
```

Finally, you can run `df` again to see the current space used.

```
7043 kattni@robocrepe:Volumes $ df -h CIRCUITPY/
Filesystem      Size  Used Avail Capacity  iused ifree %used  Mounted on
/dev/disk2s1    47Ki  34Ki  13Ki   73%    512     0 100%  /Volumes/CIRCUITPY

7044 kattni@robocrepe:Volumes $
```

Nice! You have 12Ki more than before! This space can now be used for libraries and code!

Device Locked Up or Boot Looping

In rare cases, it may happen that something in your `code.py` or `boot.py` files causes the device to get locked up, or even go into a boot loop. A boot loop occurs when the board reboots repeatedly and never fully loads. These are not caused by your everyday Python exceptions, typically it's the result of a deeper problem within CircuitPython. In this situation, it can be difficult to recover your device if CIRCUITPY is not allowing you to modify the `code.py` or `boot.py` files. Safe mode is one recovery option. When the device boots up in safe mode it will not run the `code.py` or `boot.py` scripts, but will still connect the CIRCUITPY drive so that you can remove or modify those files as needed.

The method used to manually enter safe mode can be different for different devices. It is also very similar to the method used for getting into bootloader mode, which is a different thing. So it can take a few tries to get the timing right. If you end up in bootloader mode, no problem, you can try again without needing to do anything else.

For most devices:

Press the reset button, and then when the RGB status LED blinks yellow, press the reset button again. Since your reaction time may not be that fast, try a "slow" double click, to catch the yellow LED on the second click.

For ESP32-S2 based devices:

Press and release the reset button, then press and release the boot button about 3/4 of a second later.

Refer to the diagrams above for boot sequence details.

Welcome to the Community!

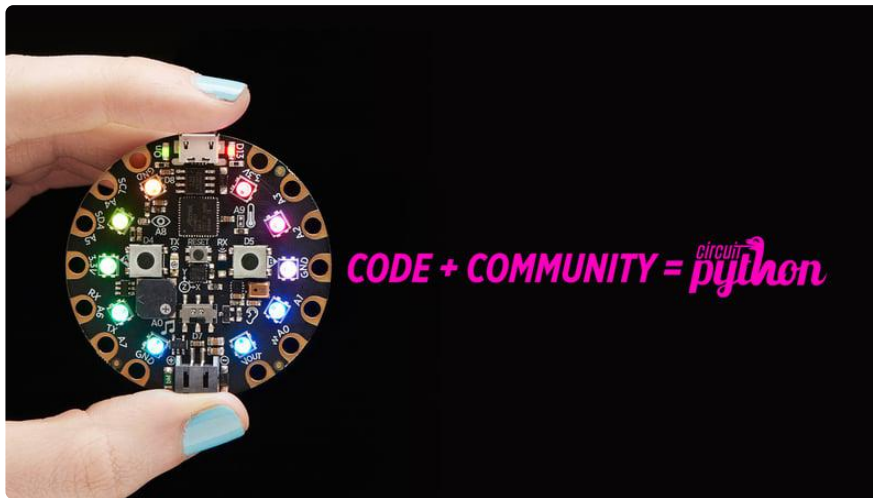

CircuitPython is a programming language that's super simple to get started with and great for learning. It runs on microcontrollers and works out of the box. You can plug it in and get started with any text editor. The best part? CircuitPython comes with an amazing, supportive community.

Everyone is welcome! CircuitPython is Open Source. This means it's available for anyone to use, edit, copy and improve upon. This also means CircuitPython becomes better because of you being a part of it. Whether this is your first microcontroller board or you're a seasoned software engineer, you have something important to offer the Adafruit CircuitPython community. This page highlights some of the many ways you can be a part of it!

Adafruit Discord

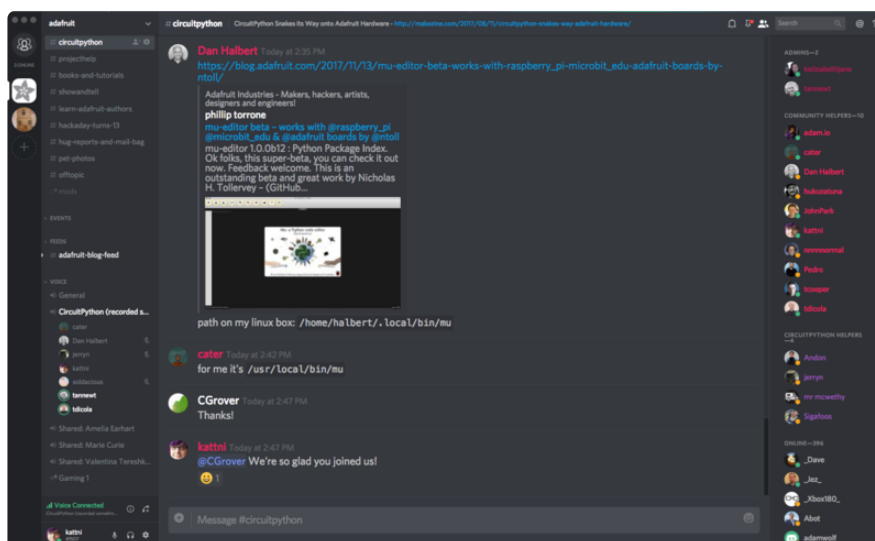

The Adafruit Discord server is the best place to start. Discord is where the community comes together to volunteer and provide live support of all kinds. From general discussion to detailed problem solving, and everything in between, Discord is a digital maker space with makers from around the world.

There are many different channels so you can choose the one best suited to your needs. Each channel is shown on Discord as "#channelname". There's the #help-with-projects channel for assistance with your current project or help coming up with ideas for your next one. There's the #show-and-tell channel for showing off your newest creation. Don't be afraid to ask a question in any channel! If you're unsure, #general is a great place to start. If another channel is more likely to provide you with a better answer, someone will guide you.

The help with CircuitPython channel is where to go with your CircuitPython questions. #help-with-circuitpython is there for new users and developers alike so feel free to ask a question or post a comment! Everyone of any experience level is welcome to join in on the conversation. Your contributions are important! The #circuitpython-dev channel is available for development discussions as well.

The easiest way to contribute to the community is to assist others on Discord. Supporting others doesn't always mean answering questions. Join in celebrating successes! Celebrate your mistakes! Sometimes just hearing that someone else has gone through a similar struggle can be enough to keep a maker moving forward.

The Adafruit Discord is the 24x7x365 hackerspace that you can bring your granddaughter to.

Visit <https://adafru.it/discord> () to sign up for Discord. Everyone is looking forward to meeting you!

CircuitPython.org



Beyond the Adafruit Learn System, which you are viewing right now, the best place to find information about CircuitPython is circuitpython.org (). Everything you need to get started with your new microcontroller and beyond is available. You can do things like [download CircuitPython for your microcontroller](#) () or [download the latest CircuitPython Library bundle](#) (), or check out [which single board computers support Blinks](#) (). You can also get to various other CircuitPython related things like Awesome CircuitPython or the Python for Microcontrollers newsletter. This is all incredibly useful, but it isn't necessarily community related. So why is it included here? The [Contributing page](#) ().

Contributing

If you'd like to contribute to the CircuitPython project, the CircuitPython libraries are a great way to begin. This page is updated with daily status information from the CircuitPython libraries, including open pull requests, open issues and library infrastructure issues.

Do you write a language other than English? Another great way to contribute to the project is to contribute new localizations (translations) of CircuitPython, or update current localizations, using [Weblate](#).

If this is your first time contributing, or you'd like to see our recommended contribution workflow, we have a guide on [Contributing to CircuitPython with Git and Github](#). You can also find us in the [#circuitpython](#) channel on the [Adafruit Discord](#).

Have an idea for a new driver or library? [File an issue on the CircuitPython repo!](#)

CircuitPython itself is written in C. However, all of the Adafruit CircuitPython libraries are written in Python. If you're interested in contributing to CircuitPython on the Python side of things, check out circuitpython.org/contributing (). You'll find information pertaining to every Adafruit CircuitPython library GitHub repository, giving you the opportunity to join the community by finding a contributing option that works for you.

Note the date on the page next to Current Status for:

Current Status for Tue, Nov 02, 2021

If you submit any contributions to the libraries, and do not see them reflected on the Contributing page, it could be that the job that checks for new updates hasn't yet run for today. Simply check back tomorrow!

Now, a look at the different options.

Pull Requests

The first tab you'll find is a list of open pull requests.

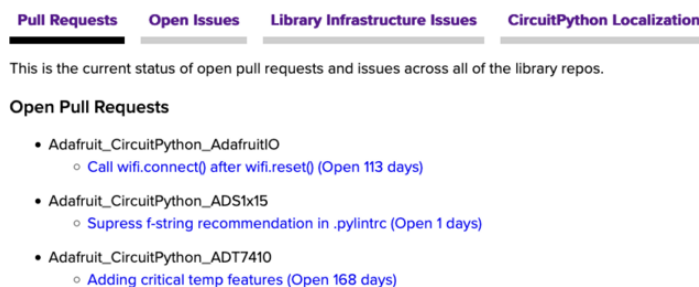

GitHub pull requests, or PRs, are opened when folks have added something to an Adafruit CircuitPython library GitHub repo, and are asking for Adafruit to add, or merge, their changes into the main library code. For PRs to be merged, they must first be reviewed. Reviewing is a great way to contribute! Take a look at the list of open pull requests, and pick one that interests you. If you have the hardware, you can test code changes. If you don't, you can still check the code updates for syntax. In the case of documentation updates, you can verify the information, or check it for spelling and grammar. Once you've checked out the update, you can leave a comment letting us know that you took a look. Once you've done that for a while, and you're more comfortable with it, you can consider joining the CircuitPythonLibrarians review team. The more reviewers we have, the more authors we can support. Reviewing is a crucial part of an open source ecosystem, CircuitPython included.

Open Issues

The second tab you'll find is a list of open issues.

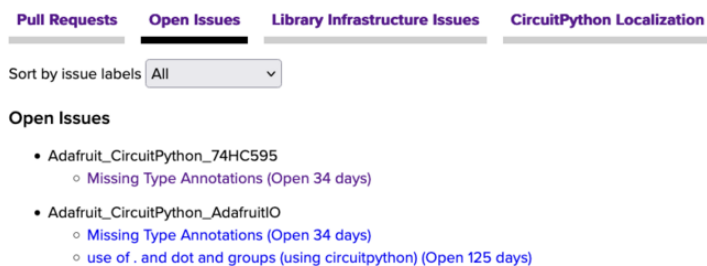

GitHub issues are filed for a number of reasons, including when there is a bug in the library or example code, or when someone wants to make a feature request. Issues are a great way to find an opportunity to contribute directly to the libraries by updating code or documentation. If you're interested in contributing code or documentation, take a look at the open issues and find one that interests you.

If you're not sure where to start, you can search the issues by label. Labels are applied to issues to make the goal easier to identify at a first glance, or to indicate the difficulty level of the issue. Click on the dropdown next to "Sort by issue labels" to see the list of available labels, and click on one to choose it.

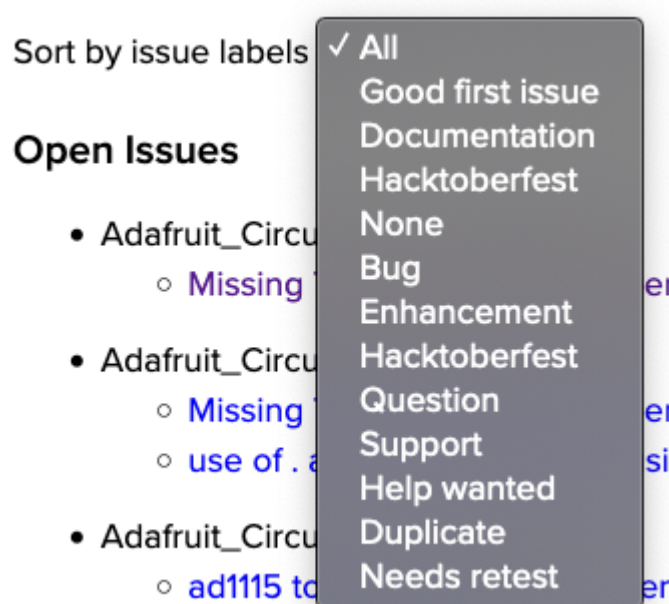

If you're new to everything, new to contributing to open source, or new to contributing to the CircuitPython project, you can choose "Good first issue". Issues with that label are well defined, with a finite scope, and are intended to be easy for someone new to figure out.

If you're looking for something a little more complicated, consider "Bug" or "Enhancement". The Bug label is applied to issues that pertain to problems or failures found in the library. The Enhancement label is applied to feature requests.

Don't let the process intimidate you. If you're new to Git and GitHub, there is [a guide](#) () to walk you through the entire process. As well, there are always folks available on [Discord](#) () to answer questions.

Library Infrastructure Issues

The third tab you'll find is a list of library infrastructure issues.

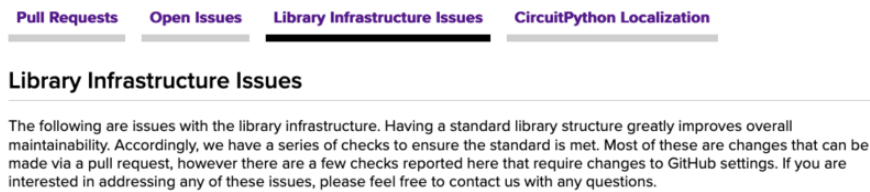

This section is generated by a script that runs checks on the libraries, and then reports back where there may be issues. It is made up of a list of subsections each containing links to the repositories that are experiencing that particular issue. This page is available mostly for internal use, but you may find some opportunities to contribute on this page. If there's an issue listed that sounds like something you could help with, mention it on Discord, or file an issue on GitHub indicating you're working to resolve that issue. Others can reply either way to let you know what the scope of it might be, and help you resolve it if necessary.

CircuitPython Localization

The fourth tab you'll find is the CircuitPython Localization tab.

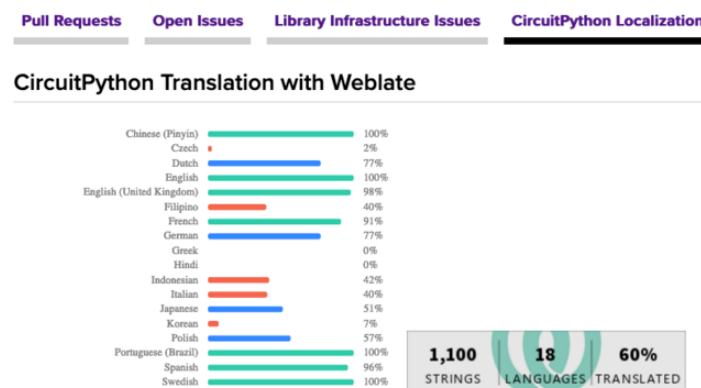

If you speak another language, you can help translate CircuitPython! The translations apply to informational and error messages that are within the CircuitPython core. It means that folks who do not speak English have the opportunity to have these messages shown to them in their own language when using CircuitPython. This is

incredibly important to provide the best experience possible for all users. CircuitPython uses Weblate to translate, which makes it much simpler to contribute translations. You will still need to know some CircuitPython-specific practices and a few basics about coding strings, but as with any CircuitPython contributions, folks are there to help.

Regardless of your skill level, or how you want to contribute to the CircuitPython project, there is an opportunity available. The [Contributing page \(\)](#) is an excellent place to start!

Adafruit GitHub

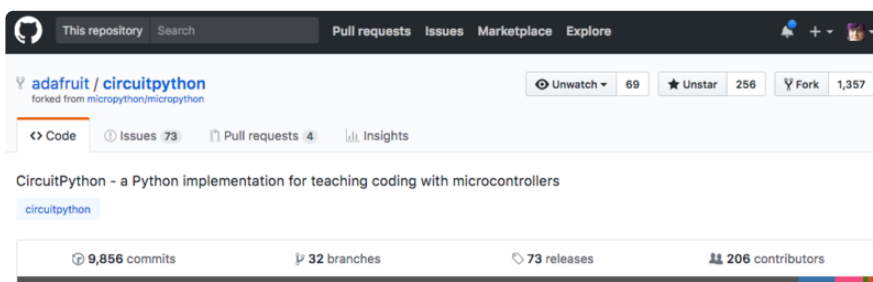

Whether you're just beginning or are life-long programmer who would like to contribute, there are ways for everyone to be a part of the CircuitPython project. The CircuitPython core is written in C. The libraries are written in Python. GitHub is the best source of ways to contribute to the [CircuitPython core \(\)](#), and the [CircuitPython libraries \(\)](#). If you need an account, visit [https://github.com/ \(\)](https://github.com/) and sign up.

If you're new to GitHub or programming in general, there are great opportunities for you. For the CircuitPython core, head over to the CircuitPython repository on GitHub, click on "[Issues \(\)](#)", and you'll find a list that includes issues labeled "[good first issue \(\)](#)". For the libraries, head over to the [Contributing page Issues list \(\)](#), and use the drop down menu to search for "[good first issue \(\)](#)". These issues are things that have been identified as something that someone with any level of experience can help with. These issues include options like updating documentation, providing feedback, and fixing simple bugs. If you need help getting started with GitHub, there is an excellent guide on [Contributing to CircuitPython with Git and GitHub \(\)](#).

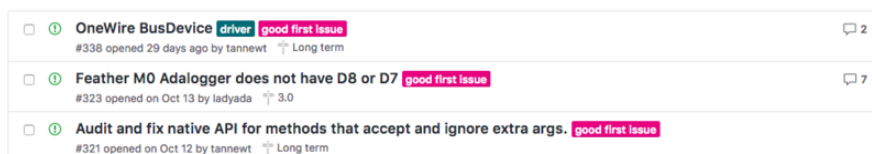

Already experienced and looking for a challenge? Checkout the rest of either issues list and you'll find plenty of ways to contribute. You'll find all sorts of things, from new

driver requests, to library bugs, to core module updates. There's plenty of opportunities for everyone at any level!

When working with or using CircuitPython or the CircuitPython libraries, you may find problems. If you find a bug, that's great! The team loves bugs! Posting a detailed issue to GitHub is an invaluable way to contribute to improving CircuitPython. For CircuitPython itself, file an issue [here](#) (). For the libraries, file an issue on the specific library repository on GitHub. Be sure to include the steps to replicate the issue as well as any other information you think is relevant. The more detail, the better!

Testing new software is easy and incredibly helpful. Simply load the newest version of CircuitPython or a library onto your CircuitPython hardware, and use it. Let us know about any problems you find by posting a new issue to GitHub. Software testing on both stable and unstable releases is a very important part of contributing CircuitPython. The developers can't possibly find all the problems themselves! They need your help to make CircuitPython even better.

On GitHub, you can submit feature requests, provide feedback, report problems and much more. If you have questions, remember that Discord and the Forums are both there for help!

Adafruit Forums

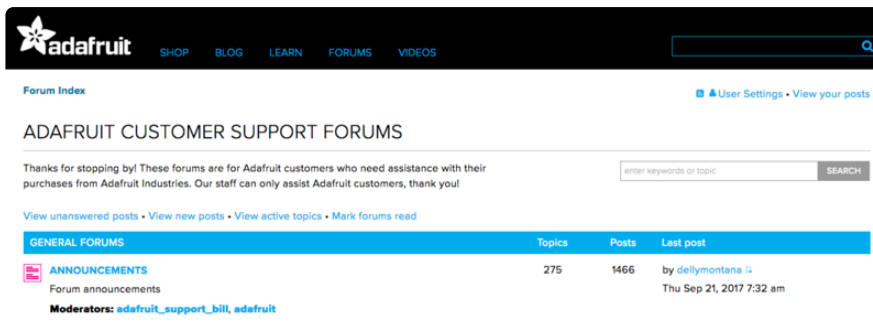

The [Adafruit Forums](#) () are the perfect place for support. Adafruit has wonderful paid support folks to answer any questions you may have. Whether your hardware is giving you issues or your code doesn't seem to be working, the forums are always there for you to ask. You need an Adafruit account to post to the forums. You can use the same account you use to order from Adafruit.

While Discord may provide you with quicker responses than the forums, the forums are a more reliable source of information. If you want to be certain you're getting an Adafruit-supported answer, the forums are the best place to be.

There are forum categories that cover all kinds of topics, including everything Adafruit. The [Adafruit CircuitPython \(\)](#) category under "Supported Products & Projects" is the best place to post your CircuitPython questions.

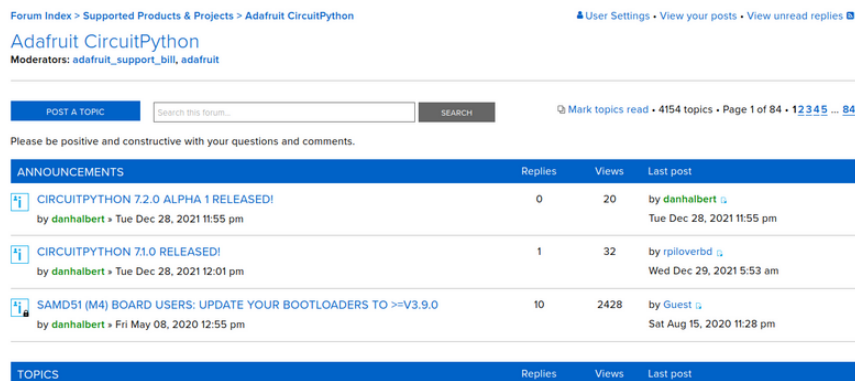

Be sure to include the steps you took to get to where you are. If it involves wiring, post a picture! If your code is giving you trouble, include your code in your post! These are great ways to make sure that there's enough information to help you with your issue.

You might think you're just getting started, but you definitely know something that someone else doesn't. The great thing about the forums is that you can help others too! Everyone is welcome and encouraged to provide constructive feedback to any of the posted questions. This is an excellent way to contribute to the community and share your knowledge!

Read the Docs

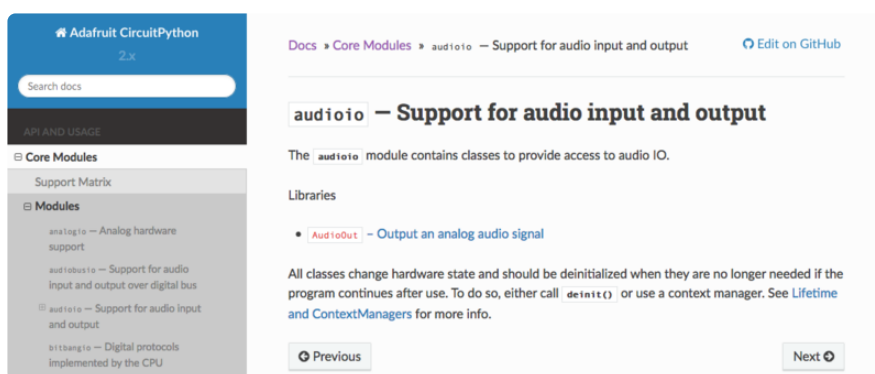

[Read the Docs \(\)](#) is an excellent resource for a more detailed look at the CircuitPython core and the CircuitPython libraries. This is where you'll find things like API documentation and example code. For an in depth look at viewing and understanding Read the Docs, check out the [CircuitPython Documentation \(\)](#) page!

Here is blinky:

```
import time
import digitalio
import board

led = digitalio.DigitalInOut(board.LED)
led.direction = digitalio.Direction.OUTPUT
while True:
    led.value = True
    time.sleep(0.1)
    led.value = False
    time.sleep(0.1)
```

CircuitPython Essentials



You've been introduced to CircuitPython, and worked through getting everything set up. What's next? CircuitPython Essentials!

There are a number of core modules built into CircuitPython, which can be used alongside the many CircuitPython libraries available. The following pages demonstrate some of these modules. Each page presents a different concept including a code example with an explanation. All of the examples are designed to work with your microcontroller board.

Time to get started learning the CircuitPython essentials!

Some examples require external components, such as switches or sensors. You'll find wiring diagrams where applicable to show you how to wire up the necessary components to work with each example.

The following components are needed to complete all of the examples:

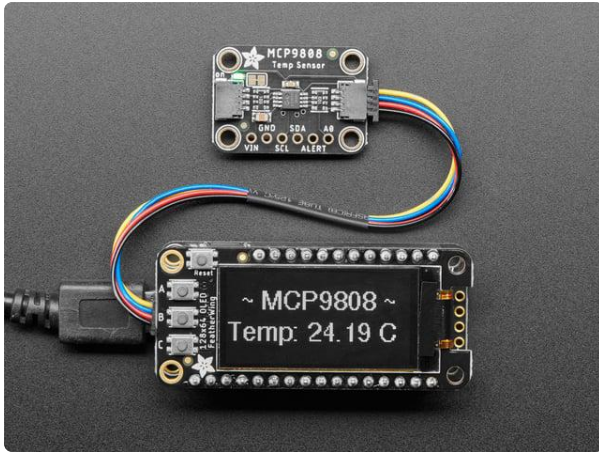

Adafruit MCP9808 High Accuracy I2C Temperature Sensor Breakout

The MCP9808 digital temperature sensor is one of the more accurate/precise we've ever seen, with a typical accuracy of $\pm 0.25^{\circ}\text{C}$ over the sensor's -40°C to...

<https://www.adafruit.com/product/5027>

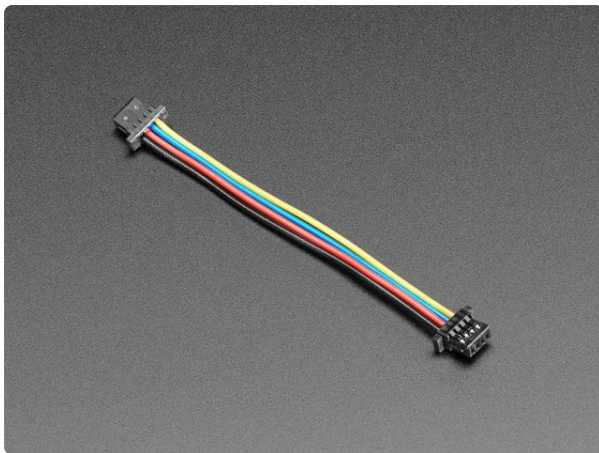

STEMMA QT / Qwiic JST SH 4-Pin Cable - 50mm Long

This 4-wire cable is 50mm / 1.9" long and fitted with JST SH female 4-pin connectors on both ends. Compared with the chunkier JST PH these are 1mm pitch instead of 2mm, but...

<https://www.adafruit.com/product/4399>

Blink

In learning any programming language, you often begin with some sort of **Hello, World!** program. In CircuitPython, Hello, World! is blinking an LED. Blink is one of the simplest programs in CircuitPython. It involves three built-in modules, two lines of set up, and a short loop. Despite its simplicity, it shows you many of the basic concepts needed for most CircuitPython programs, and provides a solid basis for more complex projects. Time to get blinky!

LED Location

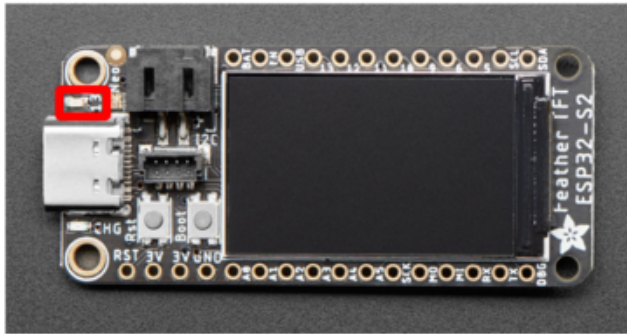

The red LED is located on the left side of the board, above the USB connector.

Blinking an LED

In the example below, click the Download Project Bundle button below to download the necessary libraries and the code.py file in a zip file. Extract the contents of the zip file, open the directory CircuitPython_Templates/blink/ and then click on the directory that matches the version of CircuitPython you're using and copy the contents of that directory to your CIRCUITPY drive.

Your CIRCUITPY drive should now look similar to the following image:



```
# SPDX-FileCopyrightText: 2021 Kattni Rembor for Adafruit Industries
# SPDX-License-Identifier: MIT
"""CircuitPython Blink Example - the CircuitPython 'Hello, World!'"
import time
import board
import digitalio

led = digitalio.DigitalInOut(board.LED)
led.direction = digitalio.Direction.OUTPUT

while True:
    led.value = True
    time.sleep(0.5)
    led.value = False
    time.sleep(0.5)
```

The built-in LED begins blinking!

Note that the code is a little less "Pythonic" than it could be. It could also be written as `led.value = not led.value` with a single `time.sleep(0.5)`. That way is more difficult to understand if you're new to programming, so the example is a bit longer than it needed to be to make it easier to read.

It's important to understand what is going on in this program.

First you `import` three modules: `time`, `board` and `digitalio`. This makes these modules available for use in your code. All three are built-in to CircuitPython, so you don't need to download anything to get started.

Next, you set up the LED. To interact with hardware in CircuitPython, your code must let the board know where to look for the hardware and what to do with it. So, you create a `digitalio.DigitalInOut()` object, provide it the LED pin using the `board` module, and save it to the variable `led`. Then, you tell the pin to act as an `OUTPUT`.

Finally, you create a `while True:` loop. This means all the code inside the loop will repeat indefinitely. Inside the loop, you set `led.value = True` which powers on the LED. Then, you use `time.sleep(0.5)` to tell the code to wait half a second before moving on to the next line. The next line sets `led.value = False` which turns the LED off. Then you use another `time.sleep(0.5)` to wait half a second before starting the loop over again.

With only a small update, you can control the blink speed. The blink speed is controlled by the amount of time you tell the code to wait before moving on using `time.sleep()`. The example uses `0.5`, which is one half of one second. Try increasing or decreasing these values to see how the blinking changes.

That's all there is to blinking an LED using CircuitPython!

TFT Basics

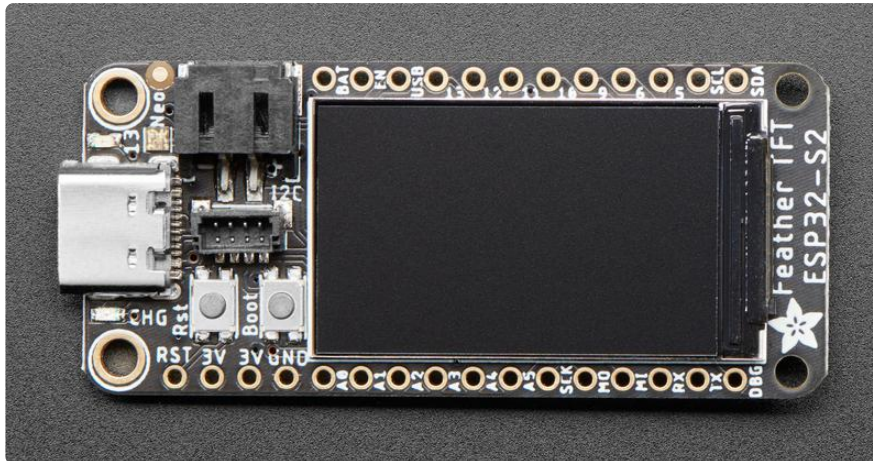

The Adafruit ESP32-S2 TFT Feather comes with a 1.14" 240x135pixel color TFT display built right in! There are a number of options for using the display. This page covers four basic ways to use the TFT display with CircuitPython: displaying the serial console/REPL, displaying simple text, displaying a bitmap, and displaying sensor data.

CircuitPython Serial Output and REPL

The most basic way to use the display happens automatically. You can view the serial console output and, when you've entered it, the REPL.

Update your code.py file to the following.

```
import time

while True:
    print("Hello, World!")
    time.sleep(4)
```

You'll see **Hello, World!** on the display, repeated every four seconds.

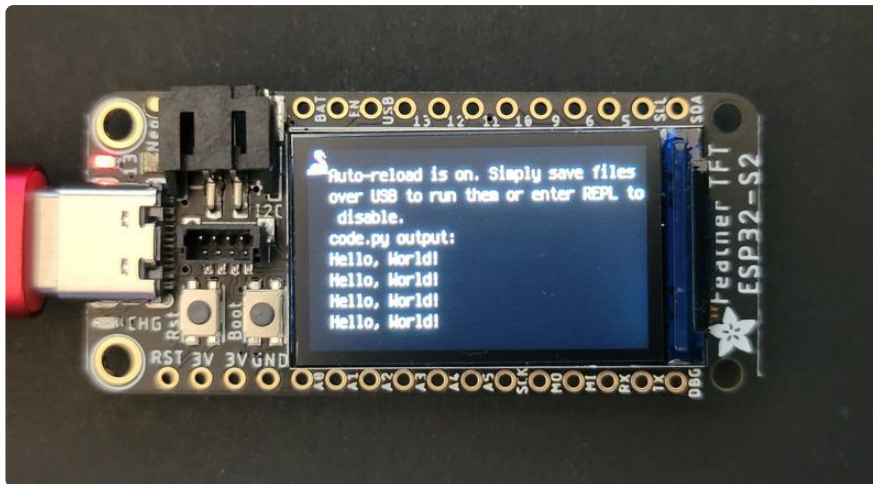

Now, if you're not already, [connect to the serial console](#) (). Then, [enter the REPL](#) (). You'll see the `>>>` prompt on the display (as well as on your computer). Try typing `1+2` into the REPL. `3`!

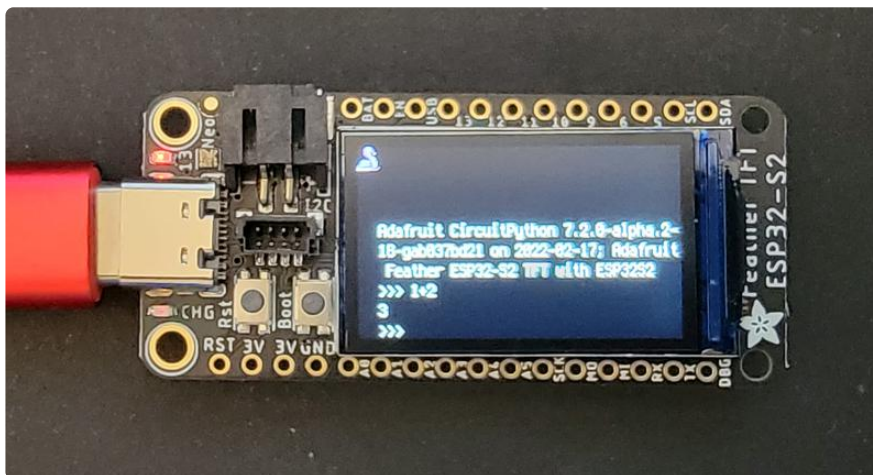

That's all there is to using the TFT display to view the CircuitPython serial console and REPL.

Simple Text Display

The Adafruit CircuitPython Display Text library allows you to display text on the TFT display. There is a font built into CircuitPython that you can use.

Update your code.py to the following. Click the Download Project Bundle button below to download the necessary libraries and the code.py file in a zip file. Extract the contents of the zip file, and copy the entire lib folder and the code.py file to your CIRCUITPY drive.

Your CIRCUITPY drive should resemble the following.



```
# SPDX-FileCopyrightText: 2021 Tim C for Adafruit Industries
# SPDX-License-Identifier: MIT
"""
CircuitPython simple text display demo
"""
import board
import terminalio
from adafruit_display_text import bitmap_label

# Update this to change the text displayed.
text = "Hello, World!"
# Update this to change the size of the text displayed. Must be a whole number.
scale = 3

text_area = bitmap_label.Label(terminalio.FONT, text=text, scale=scale)
text_area.x = 10
text_area.y = 10
board.DISPLAY.show(text_area)

while True:
    pass
```

Hello, World! is shown across the top of the display.

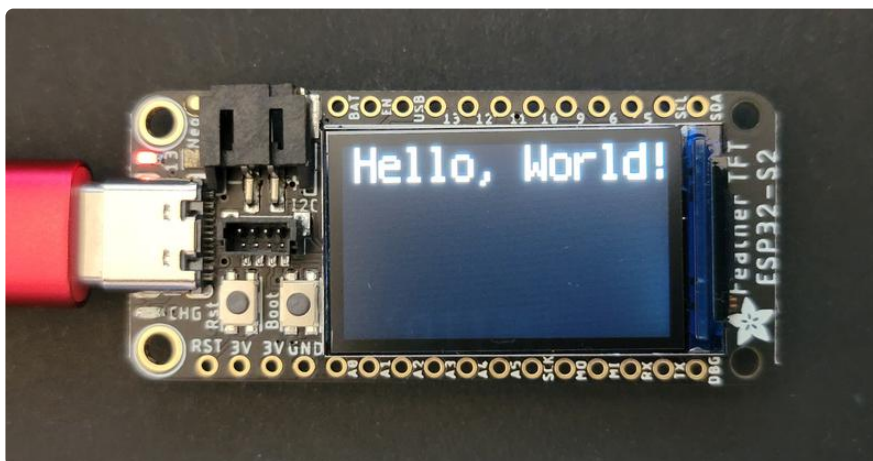

To change the text displayed, update the `text = "Hello, World!"` line. For example, to show Hello, Blinka, change it to `text = "Hello, Blinka"`.

To change the size of the text displayed, update `scale = 3`. To make the text bigger, choose a large whole number. To make the text smaller, choose a smaller whole number. Minimum scale is `1`.

That's all there is to showing a line of text on the TFT display using CircuitPython!

Simple Bitmap Display

CircuitPython has built in features, part of `displayio`, that allow you to easily display a bitmap on the TFT. This means you don't even need any external libraries!

Update your `code.py` to the following. Click the Download Project Bundle button below to download the necessary libraries and the `code.py` file in a zip file. Extract the contents of the zip file, and copy the entire `lib` folder, the entire `images` folder, and the `code.py` file to your CIRCUITPY drive.

Your CIRCUITPY drive should resemble the following.

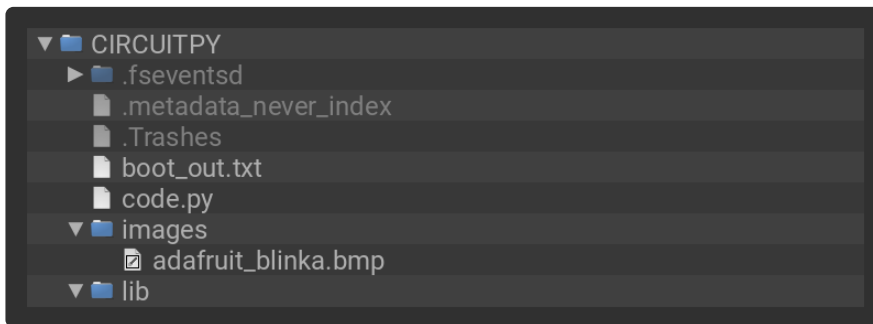

```
# SPDX-FileCopyrightText: 2021 Tim C for Adafruit Industries
# SPDX-License-Identifier: MIT
"""
CircuitPython simple bitmap display demo
"""
import board
from displayio import OnDiskBitmap, TileGrid, Group

main_group = Group()
blinka_img = OnDiskBitmap("images/adafruit_blinka.bmp")

tile_grid = TileGrid(bitmap=blinka_img, pixel_shader=blinka_img.pixel_shader)
main_group.append(tile_grid)

board.DISPLAY.show(main_group)

tile_grid.x = board.DISPLAY.width // 2 - blinka_img.width // 2

while True:
    pass
```

Blinka in the center of the display!

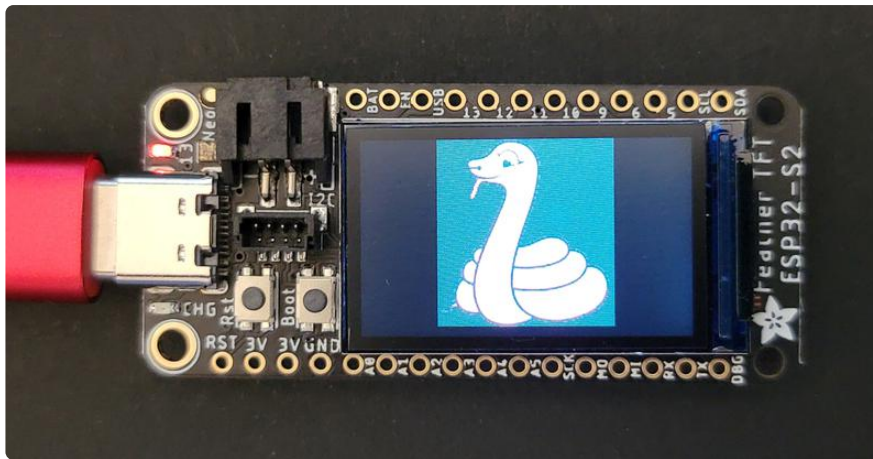

To update the bitmap file, copy your desired file to your CIRCUITPY drive. Then, change the following line to match the new filename.

```
blinka_img = OnDiskBitmap("images/adafruit_blinka.bmp")
```

For example, if you added robot.bmp to the images folder, you would change the code to read as follows.

```
blinka_img = OnDiskBitmap("images/robot.bmp")
```

That's all there is to displaying a bitmap image on the TFT display using CircuitPython!

Simple Sensor Data Display

There is an I2C LC709203 battery monitor built into the TFT Feather along with the display. The Adafruit CircuitPython LC709203F and Display Text libraries make it easy to display the sensor data on the TFT display.

You'll want to plug in a JST lipoly battery for best results.

Update your code.py to the following. Click the Download Project Bundle button below to download the necessary libraries and the code.py file in a zip file. Extract the contents of the zip file, and copy the entire lib folder and the code.py file to your CIRCUITPY drive.

Your CIRCUITPY drive should resemble the following.

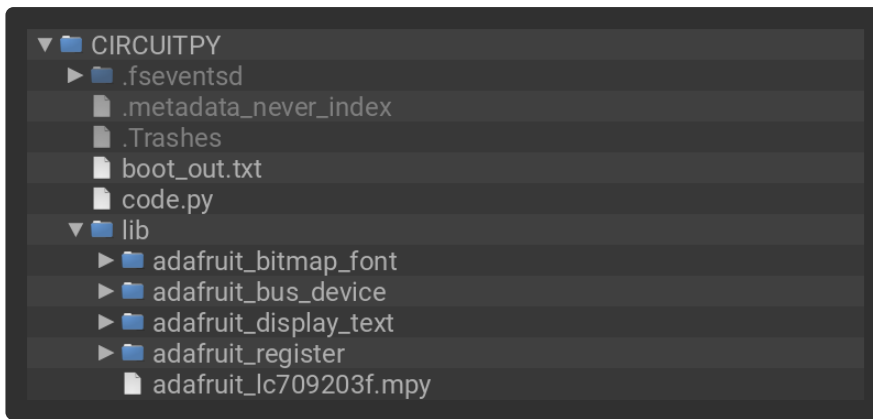

```
# SPDX-FileCopyrightText: 2021 Tim C for Adafruit Industries
# SPDX-License-Identifier: MIT
"""
CircuitPython simple sensor data display demo using LC709203 battery monitor and
TFT display
"""
import time
import board
import terminalio
from displayio import Group
from adafruit_display_text import bitmap_label
from adafruit_lc709203f import LC709203F

text_area = bitmap_label.Label(terminalio.FONT, scale=2)
text_area.anchor_point = (0.5, 0.5)
text_area.anchored_position = (board.DISPLAY.width // 2, board.DISPLAY.height // 2)

main_group = Group()

main_group.append(text_area)

print("LC709203F test")
print("Make sure LiPoly battery is plugged into the board!")

i2c = board.I2C() # uses board.SCL and board.SDA
# i2c = board.STEMMA_I2C() # For using the built-in STEMMA QT connector on a
microcontroller
sensor = LC709203F(i2c)

print("IC version:", hex(sensor.ic_version))

board.DISPLAY.show(main_group)

while True:
    text_area.text = "Battery:\n{: .1f} Volts \n{}%".format(sensor.cell_voltage,
sensor.cell_percent)
    time.sleep(1)
```

The battery voltage and percent are shown on the display!

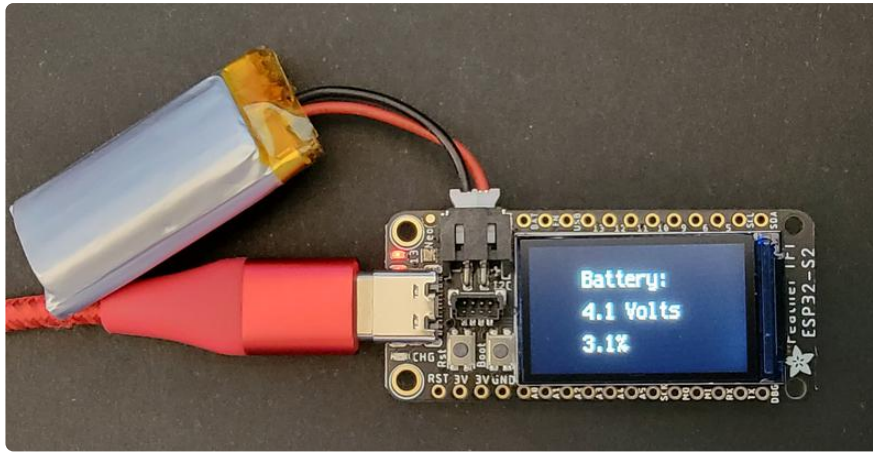

This code will run without a battery plugged in, and data will be shown on the display, but this data does not correlate to anything. Plug in a battery to get useful data!

That's all there is to displaying sensor data on the TFT using CircuitPython!

CircuitPython Internet Test

One of the great things about the ESP32 is the built-in WiFi capabilities. This page covers the basics of getting connected using CircuitPython.

The first thing you need to do is update your code.py to the following. Click the Download Project Bundle button below to download the necessary libraries and the code.py file in a zip file. Extract the contents of the zip file, and copy the entire lib folder and the code.py file to your CIRCUITPY drive.

```
# SPDX-FileCopyrightText: 2020 Brent Rubell for Adafruit Industries
#
# SPDX-License-Identifier: MIT

import ipaddress
import ssl
import wifi
import socketpool
import adafruit_requests

# URLs to fetch from
TEXT_URL = "http://wifitest.adafruit.com/testwifi/index.html"
JSON_QUOTES_URL = "https://www.adafruit.com/api/quotes.php"
JSON_STARS_URL = "https://api.github.com/repos/adafruit/circuitpython"

# Get wifi details and more from a secrets.py file
try:
    from secrets import secrets
except ImportError:
    print("WiFi secrets are kept in secrets.py, please add them there!")
    raise
```

```

print("ESP32-S2 WebClient Test")

print("My MAC addr:", [hex(i) for i in wifi.radio.mac_address])

print("Available WiFi networks:")
for network in wifi.radio.start_scanning_networks():
    print("\t%s\t\tRSSI: %d\tChannel: %d" % (str(network.ssid, "utf-8"),
        network.rssi, network.channel))
wifi.radio.stop_scanning_networks()

print("Connecting to %s"%secrets["ssid"])
wifi.radio.connect(secrets["ssid"], secrets["password"])
print("Connected to %s!"%secrets["ssid"])
print("My IP address is", wifi.radio.ipv4_address)

ipv4 = ipaddress.ip_address("8.8.4.4")
print("Ping google.com: %f ms" % (wifi.radio.ping(ipv4)*1000))

pool = socketpool.SocketPool(wifi.radio)
requests = adafruit_requests.Session(pool, ssl.create_default_context())

print("Fetching text from", TEXT_URL)
response = requests.get(TEXT_URL)
print("-" * 40)
print(response.text)
print("-" * 40)

print("Fetching json from", JSON_QUOTES_URL)
response = requests.get(JSON_QUOTES_URL)
print("-" * 40)
print(response.json())
print("-" * 40)

print()

print("Fetching and parsing json from", JSON_STARS_URL)
response = requests.get(JSON_STARS_URL)
print("-" * 40)
print("CircuitPython GitHub Stars", response.json()["stargazers_count"])
print("-" * 40)

print("done")

```

Your CIRCUITPY drive should resemble the following.

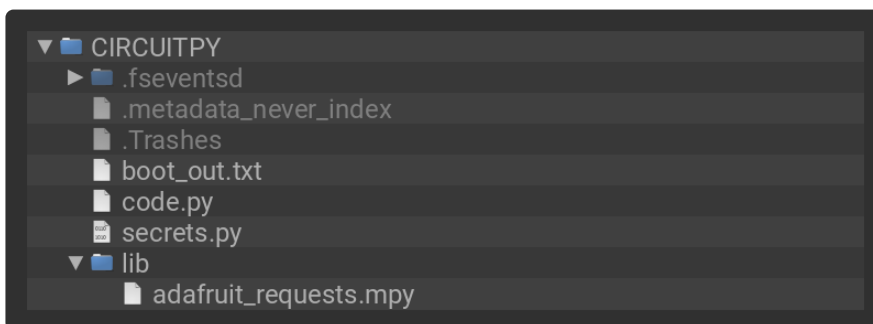

To get connected, the next thing you need to do is update the secrets.py file.

Secrets File

We expect people to share tons of projects as they build CircuitPython WiFi widgets. What we want to avoid is people accidentally sharing their passwords or secret tokens and API keys. So, we designed all our examples to use a secrets.py file, that is on your CIRCUITPY drive, to hold secret/private/custom data. That way you can share your main project without worrying about accidentally sharing private stuff.

The initial secrets.py file on your CIRCUITPY drive should look like this:

```
# SPDX-FileCopyrightText: 2020 Adafruit Industries
#
# SPDX-License-Identifier: Unlicense

# This file is where you keep secret settings, passwords, and tokens!
# If you put them in the code you risk committing that info or sharing it

secrets = {
    'ssid' : 'home_wifi_network',
    'password' : 'wifi_password',
    'aio_username' : 'my_adafruit_io_username',
    'aio_key' : 'my_adafruit_io_key',
    'timezone' : "America/New_York", # http://worldtimeapi.org/timezones
}
```

Inside is a Python dictionary named secrets with a line for each entry. Each entry has an entry name (say 'ssid') and then a colon to separate it from the entry key ('home_wifi_network') and finally a comma (,).

At a minimum you'll need to adjust the **ssid** and **password** for your local WiFi setup so do that now!

As you make projects you may need more tokens and keys, just add them one line at a time. See for example other tokens such as one for accessing GitHub or the Hackaday API. Other non-secret data like your timezone can also go here, just cause its called secrets doesn't mean you can't have general customization data in there!

For the correct time zone string, look at [http://worldtimeapi.org/timezones \(\)](http://worldtimeapi.org/timezones) and remember that if your city is not listed, look for a city in the same time zone, for example Boston, New York, Philadelphia, Washington DC, and Miami are all on the same time as New York.

Of course, don't share your secrets.py - keep that out of GitHub, Discord or other project-sharing sites.

Don't share your secrets.py file, it has your passwords and API keys in it!

If you connect to the serial console, you should see something like the following:

```
1. screen /Users/brentrubell (screen)
Auto-reload is on. Simply save files over USB to run them or enter REPL to disable.
code.py output:
ESP32-S2 WebClient Test
My MAC addr: ['0x7c', '0xdf', '0xa1', '0x0', '0x52', '0xa0']
Avaliable WiFi networks:
  Brunelleschi      RSSI: -84      Channel: 6
  Transit           RSSI: -54      Channel: 1
  Fios-5dLNb        RSSI: -66      Channel: 1
  disconnectededer   RSSI: -86      Channel: 1
  SKJFios-ZV007     RSSI: -83      Channel: 11
  Fios-QIVUQ        RSSI: -83      Channel: 11
  Fios-ZV007        RSSI: -85      Channel: 11
  [REDACTED]         RSSI: -58      Channel: 2
  [REDACTED]         RSSI: -76      Channel: 8
  NETGEAR52         RSSI: -81      Channel: 10
Connecting to Transit
Connected to Transit!
None
My IP address is 192.168.1.182
Ping google.com: 0.065000 ms
Fetching text from http://wifitest.adafruit.com/testwifi/index.html
-----
This is a test of Adafruit WiFi!
If you can read this, its working :)
-----
Fetching json from https://www.adafruit.com/api/quotes.php
-----
[{'text': 'Science, my lad, is made up of mistakes, but they are mistakes which it is u
seful to make, because they lead little by little to the truth', 'author': 'Jules Verne
'}]
-----
Fetching and parsing json from https://api.github.com/repos/adafruit/circuitpython
-----
CircuitPython GitHub Stars 1896
-----
done
```

In order, the example code...

Checks the ESP32's MAC address.

```
print("My MAC addr:", [hex(i) for i in wifi.radio.mac_address])
```

Performs a scan of all access points and prints out the access point's name (SSID), signal strength (RSSI), and channel.

```
print("Avaliable WiFi networks:")
for network in wifi.radio.start_scanning_networks():
    print("\t%s\t\tRSSI: %d\tChannel: %d" % (str(network.ssid, "utf-8"),
        network.rssi, network.channel))
wifi.radio.stop_scanning_networks()
```

Connects to the access point you defined in the secrets.py file, prints out its local IP address, and attempts to ping google.com to check its network connectivity.

```
print("Connecting to %s"%secrets["ssid"])
wifi.radio.connect(secrets["ssid"], secrets["password"])
```

```

print(print("Connected to %s!"%secrets["ssid"]))
print("My IP address is", wifi.radio.ipv4_address)

ipv4 = ipaddress.ip_address("8.8.4.4")
print("Ping google.com: %f ms" % wifi.radio.ping(ipv4))

```

The code creates a socketpool using the wifi radio's available sockets. This is performed so we don't need to re-use sockets. Then, it initializes a new instance of the [requests \(\)](#) interface - which makes getting data from the internet really really easy.

```

pool = socketpool.SocketPool(wifi.radio)
requests = adafruit_requests.Session(pool, ssl.create_default_context())

```

To read in plain-text from a web URL, call `requests.get` - you may pass in either a http, or a https url for SSL connectivity.

```

print("Fetching text from", TEXT_URL)
response = requests.get(TEXT_URL)
print("-" * 40)
print(response.text)
print("-" * 40)

```

Requests can also display a JSON-formatted response from a web URL using a call to `requests.get`.

```

print("Fetching json from", JSON_QUOTES_URL)
response = requests.get(JSON_QUOTES_URL)
print("-" * 40)
print(response.json())
print("-" * 40)

```

Finally, you can fetch and parse a JSON URL using `requests.get`. This code snippet obtains the `stargazers_count` field from a call to the GitHub API.

```

print("Fetching and parsing json from", JSON_STARS_URL)
response = requests.get(JSON_STARS_URL)
print("-" * 40)
print("CircuitPython GitHub Stars", response.json()["stargazers_count"])
print("-" * 40)

```

OK you now have your ESP32 board set up with a proper secrets.py file and can connect over the Internet. If not, check that your secrets.py file has the right ssid and password and retrace your steps until you get the Internet connectivity working!

TFT GitHub Stars WiFi Demo

The Adafruit ESP32-S2 TFT Feather comes with WiFi capabilities alongside the 1.14" 240x135pixel color TFT display. This example shows how to use the WiFi to query GitHub for the number of folks who have starred the CircuitPython project, and display the data with a lovely background on the TFT.

GitHub Stars WiFi Demo Secrets

This example requires you to provide your Wi-Fi credentials. To do this, you'll want to create a secrets.py file on your CIRCUITPY drive, with the following structure.

Update the following with your info, keeping the `"` around them:

- Replace `"your-wifi-ssid"` with your Wi-Fi SSID
- Replace `"your-wifi-password"` with your Wi-Fi password

Your secrets.py file should look like the code below, but with the above updated info.

```
# This file is where you keep secret settings, passwords, and tokens!
# If you put them in the code you risk committing that info or sharing it

secrets = {
    "ssid": "your-wifi-ssid",
    "password": "your-wifi-password",
}
```

Set Up CIRCUITPY

Update your code.py to the following. Click the Download Project Bundle button below to download the necessary libraries and the code.py file in a zip file. Extract the contents of the zip file, and copy the entire images folder, the entire fonts folder, the entire lib folder, and the code.py file to your CIRCUITPY drive.

Your CIRCUITPY drive should resemble the following.

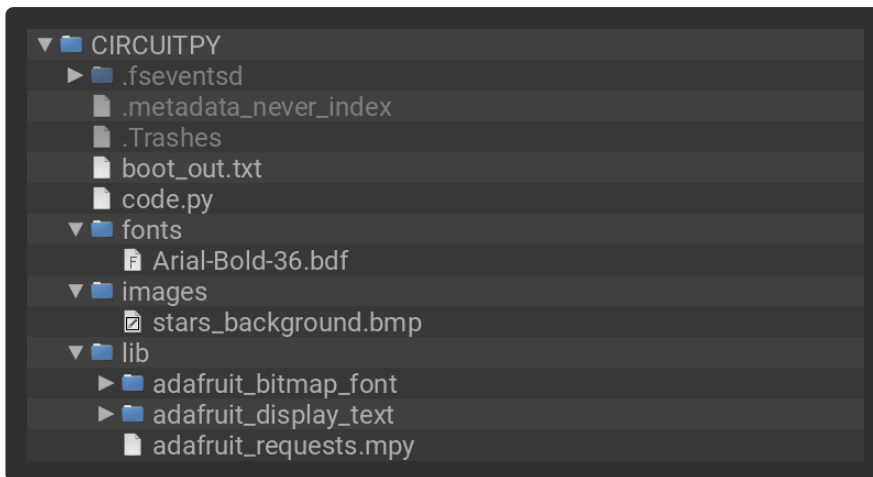

```
# SPDX-FileCopyrightText: 2021 ladyada for Adafruit Industries
# SPDX-License-Identifier: MIT
"""
CircuitPython GitHub Stars viewer
"""
import time
import ssl
import wifi
import socketpool
import displayio
import board
from adafruit_display_text import bitmap_label
from adafruit_bitmap_font import bitmap_font
import adafruit_requests

# Get WiFi details secrets.py file
try:
    from secrets import secrets
except ImportError:
    print("WiFi secrets are kept in secrets.py, please add them there!")
    raise

display = board.DISPLAY

# URL to fetch from
JSON_STARS_URL = "https://api.github.com/repos/adafruit/circuitpython"

# Set up background image and text
bitmap = displayio.OnDiskBitmap("/images/stars_background.bmp")
tile_grid = displayio.TileGrid(bitmap, pixel_shader=bitmap.pixel_shader)
group = displayio.Group()
group.append(tile_grid)
font = bitmap_font.load_font("/fonts/Arial-Bold-36.bdf")
text_area = bitmap_label.Label(font, text="----", color=0xFFFFFF)
text_area.x = 135
text_area.y = 90
group.append(text_area)
display.show(group)

# Connect to WiFi
print("Connecting to %s"%secrets["ssid"])
wifi.radio.connect(secrets["ssid"], secrets["password"])
print("Connected to %s!"%secrets["ssid"])
print("My IP address is", wifi.radio.ipv4_address)

pool = socketpool.SocketPool(wifi.radio)
requests = adafruit_requests.Session(pool, ssl.create_default_context())

while True:
    print("Fetching and parsing json from", JSON_STARS_URL)
```

```
response = requests.get(JSON_STARS_URL)
stars = response.json()["stargazers_count"]
print("-" * 40)
print("CircuitPython GitHub Stars", stars)
print("-" * 40)
text_area.text = str(stars)
time.sleep(120)
```

Once everything is copied over, the background will show up on the display with ---- in the lower right.

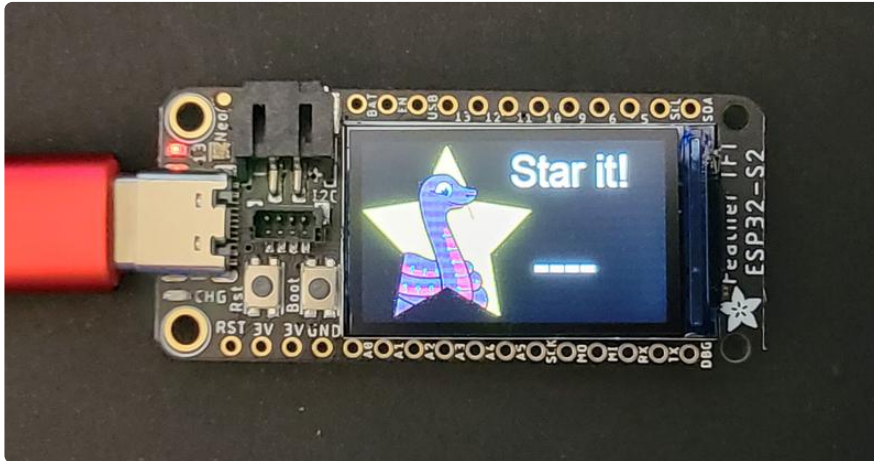

Give it a moment to connect to WiFi and query GitHub. The ---- will be replaced with the number of stars!

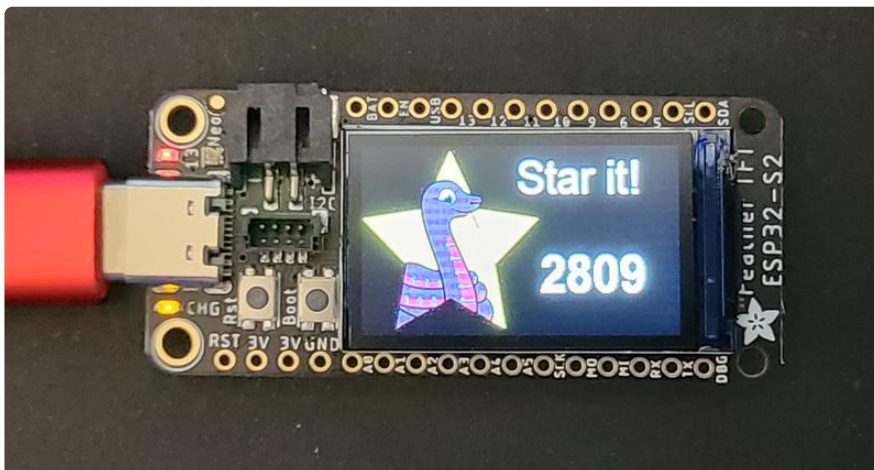

Code Walkthrough

First you import all the necessary modules and libraries, including the secrets.py file which should have your WiFi credentials in it.

Next, you set up the display.

Then you provide the URL from which to fetch the data.

Next, you set up the background image, font, and text display.

After that, you connect to the WiFi.

Inside the loop, you fetch the data from the provided URL, specify the data you're looking for (`stargazer_count`), print the data to the serial console, and update the text on the display.

Finally, you wait 120 seconds before querying again, and updating the text with the latest information.

That's all there is to connecting to WiFi and displaying JSON data on the TFT using CircuitPython!

I2C: On-Board Battery Monitor

Your microcontroller board comes with an LC709203 lithium ion polymer (lipoly) battery monitor built right onto the board. The LC709203 is available over I2C.

The LC709203 comes with its own Adafruit CircuitPython library that makes it simple to write code to read data from it. This example will be using, among other things, the [Adafruit CircuitPython LC709203F \(\)](#) library.

The example simply reads data from the battery monitor and prints it to the serial console. It is designed to show you how to get data from the battery monitor.

LC709203 Location

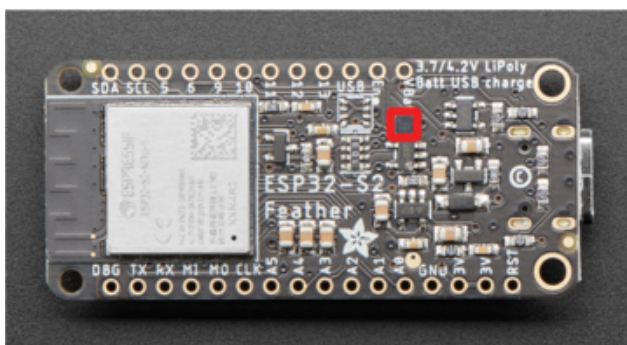

The LC709203 battery monitor (highlighted in red) is located on the bottom of the board near the VBAT pin label. Its I2C address is 0x0B. (0xb, which is returned by I2C scan, is the same as 0x0B, which simply has leading zeros.)

LC709203 Simple Data Example

To run this example, you need to first install the LC709203F library into the lib folder on your CIRCUITPY drive. Then you need to update code.py with the example script.

Thankfully, we can do this in one go. In the example below, click the Download Project Bundle button below to download the necessary libraries and the code.py file in a zip file. Extract the contents of the zip file, and copy the entire lib folder and the code.py file to your CIRCUITPY drive.

Your CIRCUITPY/lib folder should contain at least the following folder and file:

- adafruit_register/
- adafruit_lc709203f.mpy

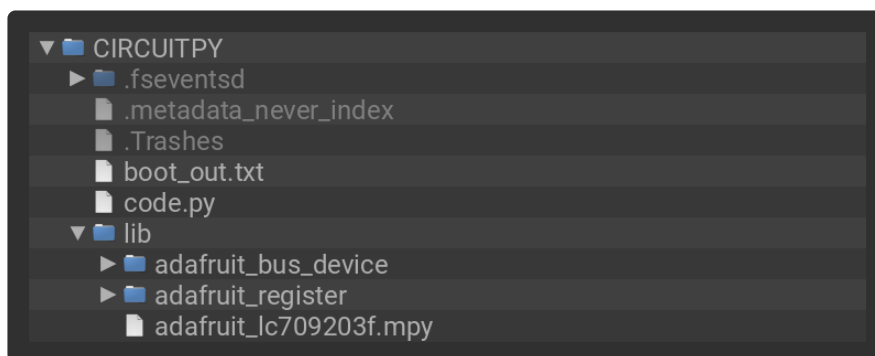

```
# SPDX-FileCopyrightText: 2022 Kattni Rembor for Adafruit Industries
# SPDX-License-Identifier: MIT
"""
CircuitPython Simple Example for LC709203 Sensor
"""
import time
import board
from adafruit_lc709203f import LC709203F, PackSize

# Create sensor object, using the board's default I2C bus.
i2c = board.I2C() # uses board.SCL and board.SDA
# i2c = board.STEMMA_I2C() # For using the built-in STEMMMA QT connector on a
microcontroller
battery_monitor = LC709203F(i2c)

# Update to match the mAh of your battery for more accurate readings.
# Can be MAH100, MAH200, MAH400, MAH500, MAH1000, MAH2000, MAH3000.
# Choose the closest match. Include "PackSize." before it, as shown.
battery_monitor.pack_size = PackSize.MAH400

while True:
    print("Battery Percent: {:.2f} %".format(battery_monitor.cell_percent))
    print("Battery Voltage: {:.2f} V".format(battery_monitor.cell_voltage))
    time.sleep(2)
```

This code will run without a battery plugged in, and voltage and charge level will be printed to the serial console, but this data does not correlate to anything. Plug in a battery to get useful data!

Now, [connect to the serial console](#) () to see the battery data printed out!

```
code.py output:
Battery Percent: 100.00 %
Battery Voltage: 4.18 V
Battery Percent: 100.00 %
Battery Voltage: 4.18 V
Battery Percent: 100.00 %
Battery Voltage: 4.18 V
```

That's all there is to reading the LC709203 data using CircuitPython!

For more details, check out the guide for the [LC709203](#) ().

Adafruit IO: Send and Receive Data

Adafruit IO gives you the option to disconnect your microcontroller from your computer and run it off of USB power or a battery, and still be able to see the data. It also allows you to send data to your microcontroller, such as NeoPixel colors. This example shows how to both send data to and receive data from Adafruit IO. It pulls from a "random" number generator and sends the "random" number to Adafruit IO, while simultaneously listening for NeoPixel color data from Adafruit IO.

NeoPixel Location

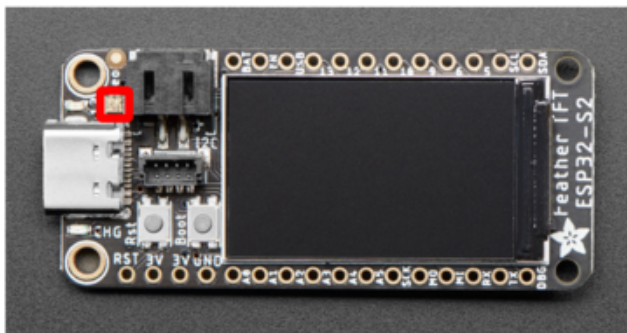

The NeoPixel (highlighted in red in the first image) is located above the USB C connector, next to the JST battery connector.

Adafruit IO Feeds and Dashboard

The first thing you'll need to do, is head over to [Adafruit IO \(\)](#) and make sure your account is set up.

Then, you need to [create two feeds \(\)](#) called neopixel and random. These are case sensitive!

Next, you'll [create a dashboard \(\)](#) for the NeoPixel Color Picker. You can name the dashboard whatever you like.

Once the dashboard is created, you'll want to [add a color picker block \(\)](#). The color picker block is highlighted by a red arrow in the image below.

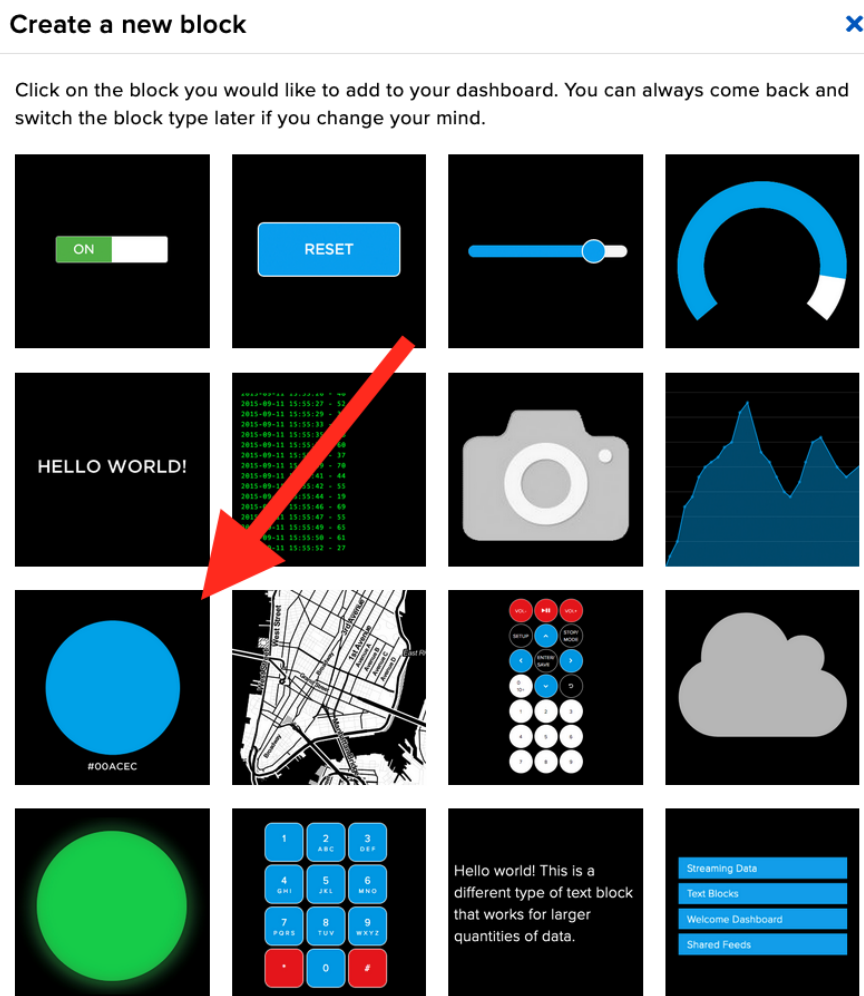

Once you choose the color picker block, you'll need to connect a feed to it. Check the box next to neopixel.

Connect a Feed ✕

The color picker is used to send or view color values in hex format.

Choose a single feed you would like to connect to this color picker. You can also create a new feed within a group.

🔍

Default ▼

Feed Name	Last value	Recorded	
<input type="checkbox"/> cpu-temperature	37.52	about 24 hours	🔒
<input checked="" type="checkbox"/> neopixel	#021fff	4 days	🔒

Create

1 of 1 feeds selected← Previous step Next step →

Finally, a Block Settings page will come up. You can add an optional block title here. Then you press Create Block.

Block settings ✕

In this final step, you can give your block a title and see a preview of how it will look. Customize the look and feel of your block with the remaining settings. When you are ready, click the "Create Block" button to send it to your dashboard.

Block Title (optional)

Block Preview

#00ACEC

Color Picker The color picker is used to send or view color values in hex format.

Test Value

Published Value

0 bytes

← Previous step Create block

The dashboard should look something like the following.



Now that things are set up on the Adafruit IO end, you can continue on to the code on your microcontroller!

Adafruit IO Example Secrets

This example requires you to provide your Wi-Fi credentials, and your Adafruit IO username and key. To do this, you'll want to create a `secrets.py` file on your CIRCUITPY drive.

To obtain your Adafruit IO key, follow [the initial steps on this page \(\)](#).

For information on how to structure your `secrets.py` file, and what information to add to it, check out [the Secrets File section on the CircuitPython Internet Test page \(\)](#).

Adafruit IO Example Code

To run this example, you need to first install the NeoPixel, Adafruit IO, and Adafruit MiniMQTT libraries into the `lib` folder on your CIRCUITPY drive. Then you need to update `code.py` with the example script.

Thankfully, we can do this in one go. In the example below, click the Download Project Bundle button below to download the necessary libraries and the `code.py` file in a zip file. Extract the contents of the zip file, and copy the entire `lib` folder and the `code.py` file to your CIRCUITPY drive.

```
# SPDX-FileCopyrightText: 2021 Ladyada for Adafruit Industries
# SPDX-FileCopyrightText: 2022 Kattni Rembor for Adafruit Industries
# SPDX-License-Identifier: MIT
import time
import ssl
from random import randint
import microcontroller
import socketpool
import wifi
import board
```

```

import neopixel
import adafruit_minimqtt.adafruit_minimqtt as MQTT
from adafruit_io.adafruit_io import IO_MQTT

try:
    from secrets import secrets
except ImportError:
    print("WiFi and Adafruit IO credentials are kept in secrets.py - please add
them there!")
    raise

# Add your Adafruit IO Username and Key to secrets.py
# (visit io.adafruit.com if you need to create an account,
# or if you need to obtain your Adafruit IO key.)
aio_username = secrets["aio_username"]
aio_key = secrets["aio_key"]

# WiFi
try:
    print("Connecting to %s" % secrets["ssid"])
    wifi.radio.connect(secrets["ssid"], secrets["password"])
    print("Connected to %s!" % secrets["ssid"])
# Wi-Fi connectivity fails with error messages, not specific errors, so this except
is broad.
except Exception as e: # pylint: disable=broad-exception
    print("Failed to connect to WiFi. Error:", e, "\nBoard will hard reset in 30
seconds.")
    time.sleep(30)
    microcontroller.reset()

# Initialise NeoPixel
pixel = neopixel.NeoPixel(board.NEOPIXEL, 1, brightness=0.3)

# Define callback functions which will be called when certain events happen.
def connected(client):
    print("Connected to Adafruit IO! Listening for NeoPixel changes...")
    # Subscribe to Adafruit IO feed called "neopixel"
    client.subscribe("neopixel")

def message(client, feed_id, payload): # pylint: disable=unused-argument
    print("Feed {0} received new value: {1}".format(feed_id, payload))
    if feed_id == "neopixel":
        pixel.fill(int(payload[1:]), 16)

# Create a socket pool
pool = socketpool.SocketPool(wifi.radio)

# Initialize a new MQTT Client object
mqtt_client = MQTT.MQTT(
    broker="io.adafruit.com",
    username=secrets["aio_username"],
    password=secrets["aio_key"],
    socket_pool=pool,
    ssl_context=ssl.create_default_context(),
)

# Initialize Adafruit IO MQTT "helper"
io = IO_MQTT(mqtt_client)

# Set up the callback methods above
io.on_connect = connected
io.on_message = message

timestamp = 0
while True:
    try:

```

```

# If Adafruit IO is not connected...
if not io.is_connected:
    # Connect the client to the MQTT broker.
    print("Connecting to Adafruit IO...")
    io.connect()

# Explicitly pump the message loop.
io.loop()
# Obtain the "random" value, print it and publish it to Adafruit IO every
10 seconds.
if (time.monotonic() - timestamp) >= 10:
    random_number = "{}".format(randint(0, 255))
    print("Current 'random' number: {}".format(random_number))
    io.publish("random", random_number)
    timestamp = time.monotonic()

# Adafruit IO fails with internal error types and WiFi fails with specific
messages.
# This except is broad to handle any possible failure.
except Exception as e: # pylint: disable=broad-exception
    print("Failed to get or send data, or connect. Error:", e,
          "\nBoard will hard reset in 30 seconds.")
    time.sleep(30)
    microcontroller.reset()

```

Your CIRCUITPY/lib folder should contain at least the following folders and files:

- adafruit_io/
- adafruit_minimqtt/
- neopixel.mpy

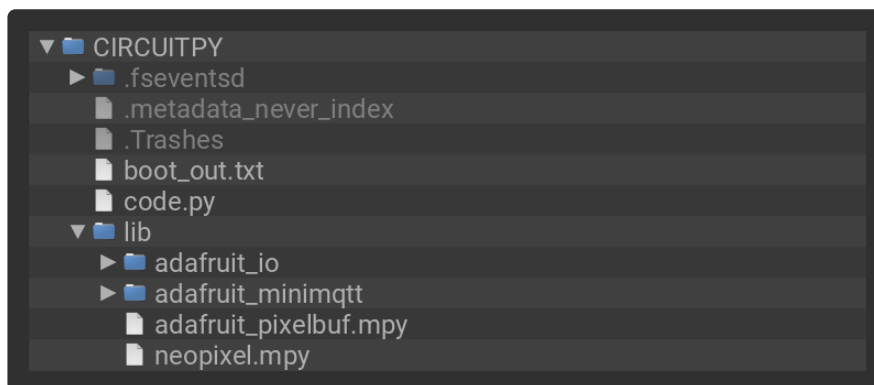

If you like, you can [connect to the serial console \(\)](#) to see the connection info and current readings printed out.



NeoPixel Color Change

To change the color of the NeoPixel, go to the NeoPixel Adafruit IO dashboard you created at the beginning, and click on the colored circle in the ColorPicker block. It will bring up the following.

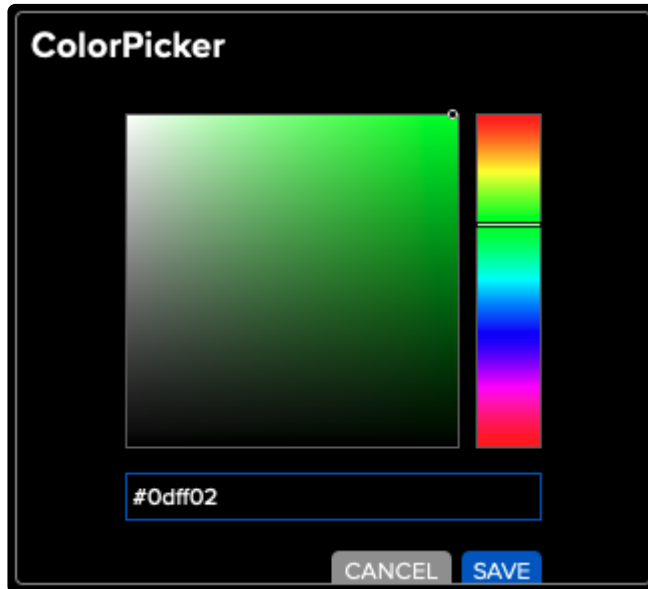

You can move the dot in the box around, and the slider line across the gradient to choose the perfect color. Choose a new color and click SAVE.

The NeoPixel color will update, and you will see the new value printed to the serial console, as shown below.

```
Current 'random' number: 4
Current 'random' number: 68
Feed neopixel received new value: #cc02ff
```

Code Walkthrough

This example contains three `try / except` blocks. These are included where the code is likely to fail due to WiFi or Adafruit IO connection failures. WiFi can be finicky, and without these code blocks, if the connection was lost, the code would crash. Instead, it is designed to reset the board and start the code over again to reestablish the connection, regardless of the cause. This ensures your code will continue running. The details of these blocks are explained below.

First you import all of the necessary modules and libraries. This includes importing the data from your secrets.py file.

```

import time
import ssl
from random import randint
import socketpool
import wifi
import board
import neopixel
import adafruit_minimqtt.adafruit_minimqtt as MQTT
from adafruit_io.adafruit_io import IO_MQTT

try:
    from secrets import secrets
except ImportError:
    print("WiFi and Adafruit IO credentials are kept in secrets.py - please add
them there!")
    raise

```

Note that if a `secrets.py` file is not present on your CIRCUITPY drive, the code will fail to run, and you will receive an error in the serial console. Add a `secrets.py` file to your CIRCUITPY drive to resolve this error.

The code pulls your Adafruit IO username and key from `secrets.py`.

```

aio_username = secrets["aio_username"]
aio_key = secrets["aio_key"]

```

The WiFi attempts to connect, and prints the status to the serial console. If it connects successfully, the code continues onto the NeoPixel set up.

```

try:
    print("Connecting to %s" % secrets["ssid"])
    wifi.radio.connect(secrets["ssid"], secrets["password"])
    print("Connected to %s!" % secrets["ssid"])

```

If the WiFi connection is not successful, the error will be printed to the serial console, and the board will hard reset after 30 seconds.

```

except Exception as e: # pylint: disable=broad-exception
    print("Failed to connect to WiFi. Error:", e, "\nBoard will hard reset in 30
seconds.")
    time.sleep(30)
    microcontroller.reset()

```

Once the WiFi successfully connects, the NeoPixel object is initiated.

```

pixel = neopixel.NeoPixel(board.NEOPIXEL, 1, brightness=0.3)

```

Following that are two callback methods. For more details, check out [this guide \(\)](#). The `connected` method subscribes to the neopixel feed on Adafruit IO. The `message`

callback checks for updates to the neopixel feed, and turns the pixel the color from the feed.

```
def connected(client):
    print("Connected to Adafruit IO! Listening for NeoPixel changes...")
    # Subscribe to Adafruit IO feed called "neopixel"
    client.subscribe("neopixel")

# pylint: disable=unused-argument
def message(client, feed_id, payload):
    print("Feed {0} received new value: {1}".format(feed_id, payload))
    if feed_id == "neopixel":
        pixel.fill(int(payload[1:], 16))
```

You create a socket pool, use that to initialise the new MQTT Client object, and use that to initialise the Adafruit IO MQTT "helper".

```
pool = socketpool.SocketPool(wifi.radio)

mqtt_client = MQTT.MQTT(
    broker="io.adafruit.com",
    username=secrets["aio_username"],
    password=secrets["aio_key"],
    socket_pool=pool,
    ssl_context=ssl.create_default_context(),
)

io = IO_MQTT(mqtt_client)
```

You set up the callback methods mentioned above.

```
io.on_connect = connected
io.on_message = message
```

Next, you attempt to connect the client to the MQTT broker. If connection is successful, the code continues on to the `timestamp`.

```
try:
    io.connect()
```

If the MQTT broker connection is not successful, the error is printed to the serial console, and the board will hard reset after 30 seconds.

```
except Exception as e:
    print("Failed to connect to Adafruit IO. Error:", e, "\nBoard will hard reset in 30 seconds.")
    time.sleep(30)
    microcontroller.reset()
```

Once the broker is connected, you set the `timestamp` to `0` immediately before the loop.

```
timestamp = 0
```

Inside the loop, you attempt to do two things. You first explicitly poll the message loop. Check out [this guide \(\)](#) for more details on that.

```
while True:
    try:
        io.loop()
```

Second, you have a block of code that runs every 10 seconds. Inside, you obtain a "random" value between 0-255 inclusive, print it to the serial console, and publish it to an Adafruit IO feed. Finally, you reset `timestamp` so the block of code knows when another 10 seconds has passed, and runs again.

```
[...]
    if (time.monotonic() - timestamp) >= 10:
        random_number = "{}".format(randint(0, 255))
        print("Current 'random' number: {}".format(random_number))
        io.publish("random", random_number)
        timestamp = time.monotonic()
```

If at any time WiFi or Adafruit IO disconnects, the code will print the error to the serial console, and the board will hard reset after 30 seconds.

```
[...]
    except Exception as e:
        print("Failed to get or send data, or connect. Error:", e,
              "\nBoard will hard reset in 30 seconds.")
        time.sleep(30)
        microcontroller.reset()
```

That's all there is to using CircuitPython and Adafruit IO to send data to Adafruit IO, and receive data from it!

I2C: External Sensor

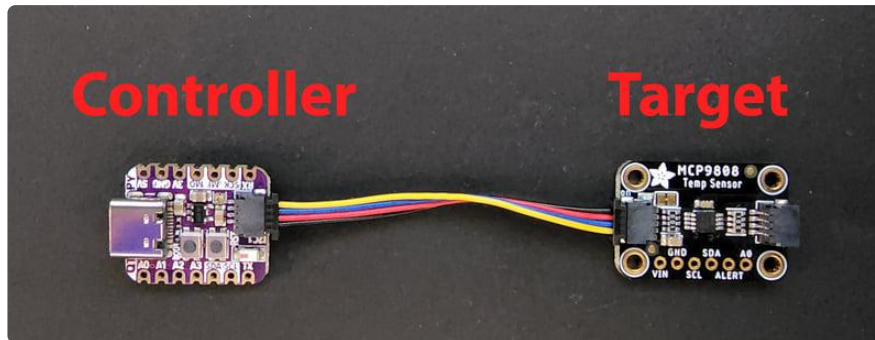

The I2C, or [inter-integrated circuit \(\)](#), is a 2-wire protocol for communicating with simple sensors and devices, which means it uses two connections, or wires, for transmitting and receiving data. One connection is a clock, called SCL. The other is the data line, called SDA. Each pair of clock and data pins are referred to as a bus.

Typically, there is a device that acts as a controller and sends requests to the target devices on each bus. In this case, your microcontroller board acts as the controller, and the sensor breakout acts as the target. Historically, the controller is referred to as the master, and the target is referred to as the slave, so you may run into that terminology elsewhere. The official terminology is [controller and target \(\)](#).

Multiple I2C devices can be connected to the same clock and data lines. Each I2C device has an address, and as long as the addresses are different, you can connect them at the same time. This means you can have many different sensors and devices all connected to the same two pins.

Both I2C connections require pull-up resistors, and most Adafruit I2C sensors and breakouts have pull-up resistors built in. If you're using one that does not, you'll need to add your own 2.2-10kΩ pull-up resistors from SCL and SDA to 3.3V.

I2C and CircuitPython

CircuitPython supports many I2C devices, and makes it super simple to interact with them. There are libraries available for many I2C devices in the [CircuitPython Library Bundle \(\)](#). (If you don't see the sensor you're looking for, keep checking back, more are being written all the time!)

In this section, you'll learn how to scan the I2C bus for all connected devices. Then you'll learn how to interact with an I2C device.

Necessary Hardware

You'll need the following additional hardware to complete the examples on this page.

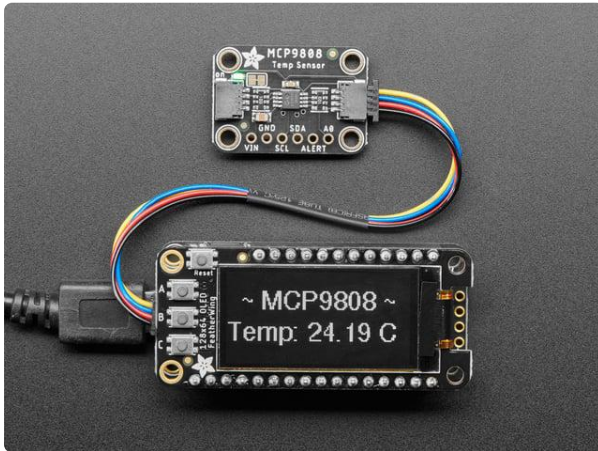

[Adafruit MCP9808 High Accuracy I2C Temperature Sensor Breakout](https://www.adafruit.com/product/5027)

The MCP9808 digital temperature sensor is one of the more accurate/precise we've ever seen, with a typical accuracy of $\pm 0.25^{\circ}\text{C}$ over the sensor's -40°C to...

<https://www.adafruit.com/product/5027>

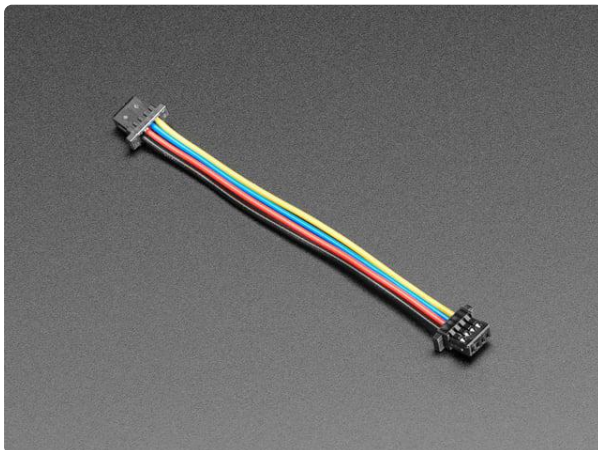

[STEMMA QT / Qwiic JST SH 4-Pin Cable - 50mm Long](https://www.adafruit.com/product/4399)

This 4-wire cable is 50mm / 1.9" long and fitted with JST SH female 4-pin connectors on both ends. Compared with the chunkier JST PH these are 1mm pitch instead of 2mm, but...

<https://www.adafruit.com/product/4399>

While the examples here will be using the [Adafruit MCP9808 \(\)](https://www.adafruit.com/product/5027), a high accuracy temperature sensor, the overall process is the same for just about any I2C sensor or device.

The first thing you'll want to do is get the sensor connected so your board has I2C to talk to.

Wiring the MCP9808

The MCP9808 comes with a STEMMA QT connector, which makes wiring it up quite simple and solder-free.

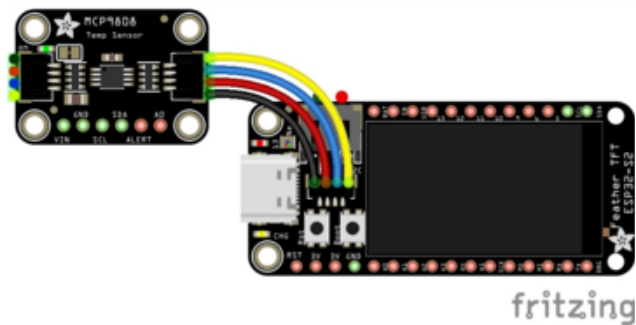

Simply connect the STEMMA QT cable from the STEMMA QT port on your board to the STEMMA QT port on the MCP9808.

Find Your Sensor

The first thing you'll want to do after getting the sensor wired up, is make sure it's wired correctly. You're going to do an I2C scan to see if the board is detected, and if it is, print out its I2C address.

Save the following to your CIRCUITPY drive as code.py.

Click the Download Project Bundle button below to download the necessary libraries and the code.py file in a zip file. Extract the contents of the zip file, find your CircuitPython version, and copy the matching code.py file to your CIRCUITPY drive.

Your CIRCUITPY drive should now look similar to the following image:

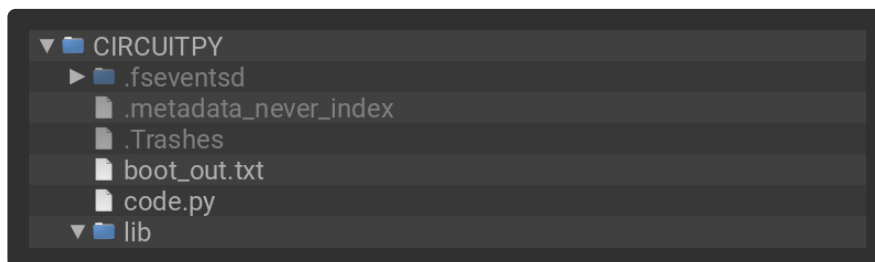

```
# SPDX-FileCopyrightText: 2021 Kattni Rembor for Adafruit Industries
# SPDX-License-Identifier: MIT
"""CircuitPython I2C Device Address Scan"""
import time
import board

i2c = board.I2C() # uses board.SCL and board.SDA
# i2c = board.STEMMA_I2C() # For using the built-in STEMMA QT connector on a
microcontroller

# To create I2C bus on specific pins
# import busio
# i2c = busio.I2C(board.GP1, board.GP0) # Pi Pico RP2040

while not i2c.try_lock():
```

```

pass
try:
    while True:
        print(
            "I2C addresses found:",
            [hex(device_address) for device_address in i2c.scan()],
        )
        time.sleep(2)
finally: # unlock the i2c bus when ctrl-c'ing out of the loop
    i2c.unlock()

```

The TFT Feather comes with one I2C sensor built in. The I2C scan code will show the addresses from the built in sensor and the MCP9808.

```

Auto-reload is on. Simply save files over USB to run them or enter REPL to disable.
code.py output:
I2C addresses found: ['0x18']

```

If you run this and it seems to hang, try manually unlocking your I2C bus by running the following two commands from the REPL.

```

import board
board.I2C().unlock()

```

First you create the `i2c` object, using `board.I2C()`. This convenience routine creates and saves a `busio.I2C` object using the default pins `board.SCL` and `board.SDA`. If the object has already been created, then the existing object is returned. No matter how many times you call `board.I2C()`, it will return the same object. This is called a singleton.

To be able to scan it, you need to lock the I2C down so the only thing accessing it is the code. So next you include a loop that waits until I2C is locked and then continues on to the scan function.

Last, you have the loop that runs the actual scan, `i2c_scan()`. Because I2C typically refers to addresses in hex form, the example includes this bit of code that formats the results into hex format: `[hex(device_address) for device_address in i2c.scan()]`.

Open the serial console to see the results! The code prints out an array of addresses. You've connected the MCP9808 which has a 7-bit I2C address of 0x18. The result for this sensor is `I2C addresses found: ['0x18']`. If no addresses are returned, refer back to the wiring diagrams to make sure you've wired up your sensor correctly.

I2C Sensor Data

Now you know for certain that your sensor is connected and ready to go. Time to find out how to get the data from the sensor!

Save the following to your CIRCUITPY drive as code.py.

Click the Download Project Bundle button below to download the necessary libraries and the code.py file in a zip file. Extract the contents of the zip file, find your CircuitPython version, and copy the matching entire lib folder and code.py file to your CIRCUITPY drive.

Your CIRCUITPY drive should now look similar to the following image:

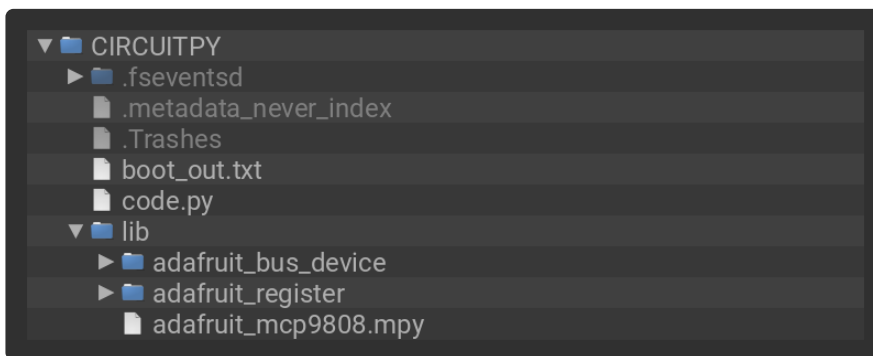

```
# SPDX-FileCopyrightText: 2021 Kattni Rembor for Adafruit Industries
# SPDX-License-Identifier: MIT
"""CircuitPython I2C MCP9808 Temperature Sensor Example"""
import time
import board
import adafruit_mcp9808

i2c = board.I2C() # uses board.SCL and board.SDA
# i2c = board.STEMMA_I2C() # For using the built-in STEMMA QT connector on a
microcontroller
# import busio
# i2c = busio.I2C(board.SCL1, board.SDA1) # For QT Py RP2040, QT Py ESP32-S2
mcp9808 = adafruit_mcp9808.MCP9808(i2c)

while True:
    temperature_celsius = mcp9808.temperature
    temperature_fahrenheit = temperature_celsius * 9 / 5 + 32
    print("Temperature: {:.2f} C {:.2f} F ".format(temperature_celsius,
temperature_fahrenheit))
    time.sleep(2)
```

```
Auto-reload is on. Simply save files over USB to run them or enter REPL to disab
le.
code.py output:
Temperature: 23.38 C 74.07 F
```

For the ESP32-S2 TFT Feather, you'll need to change the I2C setup to the commented out setup included in the code above.

The ESP32-S2 TFT Feather STEMMA QT connector is available on `board.STEMMA_I2C()`. Comment out the current `i2c` setup line, and uncomment the the `i2c = board.STEMMA_I2C()` line to use with your board's STEMMA QT connector.

This code begins the same way as the scan code, except this time, you create your sensor object using the sensor library. You call it `mcp9808` and provide it the `i2c` object.

Then you have a simple loop that prints out the temperature reading using the sensor object you created. Finally, there's a `time.sleep(2)`, so it only prints once every two seconds. Connect to the serial console to see the results. Try touching the MCP9808 with your finger to see the values change!

Where's my I2C?

On many microcontrollers, you have the flexibility of using a wide range of pins for I2C. On some types of microcontrollers, any pin can be used for I2C! Other chips require using bitbangio, but can also use any pins for I2C. There are further microcontrollers that may have fixed I2C pins.

Given the many different types of microcontroller boards available, it's impossible to guarantee anything other than the labeled 'SDA' and 'SCL' pins. So, if you want some other setup, or multiple I2C interfaces, how will you find those pins? Easy! Below is a handy script.

Save the following to your CIRCUITPY drive as code.py.

Click the Download Project Bundle button below to download the necessary libraries and the code.py file in a zip file. Extract the contents of the zip file, find your CircuitPython version, and copy the matching code.py file to your CIRCUITPY drive.

Your CIRCUITPY drive should now look similar to the following image:

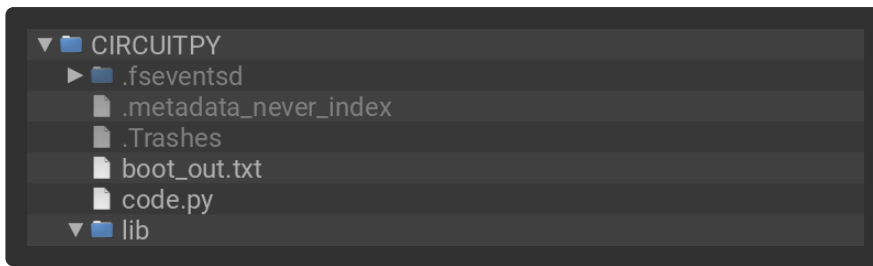

```
# SPDX-FileCopyrightText: 2021 Kattni Rembor for Adafruit Industries
# SPDX-License-Identifier: MIT
"""CircuitPython I2C possible pin-pair identifying script"""
import board
import busio
from microcontroller import Pin

def is_hardware_i2c(scl, sda):
    try:
        p = busio.I2C(scl, sda)
        p.deinit()
        return True
    except ValueError:
        return False
    except RuntimeError:
        return True

def get_unique_pins():
    exclude = [
        getattr(board, p)
        for p in [
            # This is not an exhaustive list of unexposed pins. Your results
            # may include other pins that you cannot easily connect to.
            "NEOPIXEL",
            "DOTSTAR_CLOCK",
            "DOTSTAR_DATA",
            "APA102_SCK",
            "APA102_MOSI",
            "LED",
            "SWITCH",
            "BUTTON",
            "ACCELEROMETER_INTERRUPT",
            "VOLTAGE_MONITOR",
            "MICROPHONE_CLOCK",
            "MICROPHONE_DATA",
        ]
        if p in dir(board)
    ]
    pins = [
        pin
        for pin in [getattr(board, p) for p in dir(board)]
        if isinstance(pin, Pin) and pin not in exclude
    ]
    unique = []
    for p in pins:
        if p not in unique:
            unique.append(p)
    return unique

for scl_pin in get_unique_pins():
    for sda_pin in get_unique_pins():
        if scl_pin is sda_pin:
            continue
```

```
if is_hardware_i2c(scl_pin, sda_pin):  
    print("SCL pin:", scl_pin, "\t SDA pin:", sda_pin)
```

Now, connect to the serial console and check out the output! The results print out a nice handy list of SCL and SDA pin pairs that support I2C.



```
Auto-reload is on. Simply save files over USB to run them or enter REPL to disable.  
code.py output:  
SCL pin: board.D18      SDA pin: board.D17  
SCL pin: board.D18      SDA pin: board.D16  
SCL pin: board.D18      SDA pin: board.D15  
SCL pin: board.D18      SDA pin: board.D14  
SCL pin: board.D18      SDA pin: board.D8  
SCL pin: board.D18      SDA pin: board.D1  
SCL pin: board.D18      SDA pin: board.D10  
SCL pin: board.D18      SDA pin: board.D11
```

The output for the TFT Feather is extremely long! The screenshot shows only the beginning. Run the script yourself to see the full output!

This example only runs once, so if you do not see any output when you connect to the serial console, try CTRL+D to reload.

Analog In

Your microcontroller board has both digital and analog signal capabilities. Some pins are analog, some are digital, and some are capable of both. Check the Pinouts page in this guide for details about your board.

Analog signals are different from digital signals in that they can be any voltage and can vary continuously and smoothly between voltages. An analog signal is like a dimmer switch on a light, whereas a digital signal is like a simple on/off switch.

Digital signals only can ever have two states, they are either are on (high logic level voltage like 3.3V) or off (low logic level voltage like 0V / ground).

By contrast, analog signals can be any voltage in-between on and off, such as 1.8V or 0.001V or 2.98V and so on.

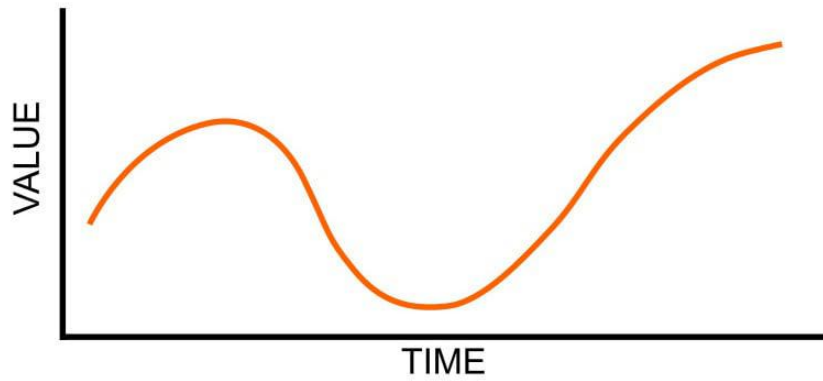

Analog signals are continuous values which means they can be an infinite number of different voltages. Think of analog signals like a floating point or fractional number, they can smoothly transition to any in-between value like 1.8V, 1.81V, 1.801V, 1.8001V, 1.80001V and so forth to infinity.

Many devices use analog signals, in particular sensors typically output an analog signal or voltage that varies based on something being sensed like light, heat, humidity, etc.

Analog to Digital Converter (ADC)

An analog-to-digital-converter, or ADC, is the key to reading analog signals and voltages with a microcontroller. An ADC is a device that reads the voltage of an analog signal and converts it into a digital, or numeric, value. The microcontroller can't read analog signals directly, so the analog signal is first converted into a numeric value by the ADC.

The black line below shows a digital signal over time, and the red line shows the converted analog signal over the same amount of time.

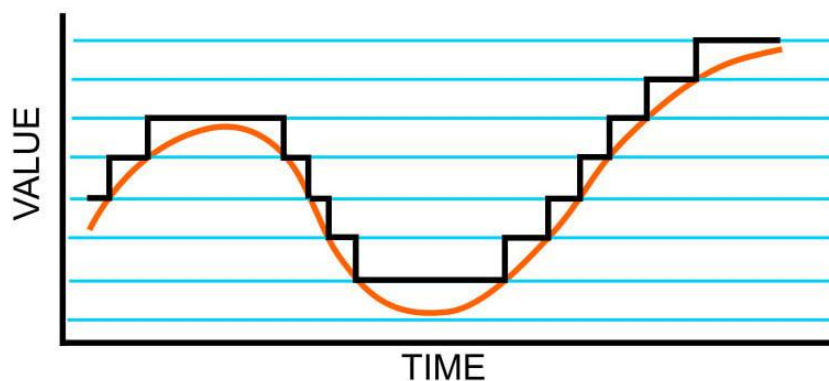

Once that analog signal has been converted by the ADC, the microcontroller can use those digital values any way you like!

Potentiometers

A potentiometer is a small variable resistor that you can twist a knob or shaft to change its resistance. It has three pins. By twisting the knob on the potentiometer you can change the resistance of the middle pin (called the wiper) to be anywhere within the range of resistance of the potentiometer.

By wiring the potentiometer to your board in a special way (called a voltage divider) you can turn the change in resistance into a change in voltage that your board's analog to digital converter can read.

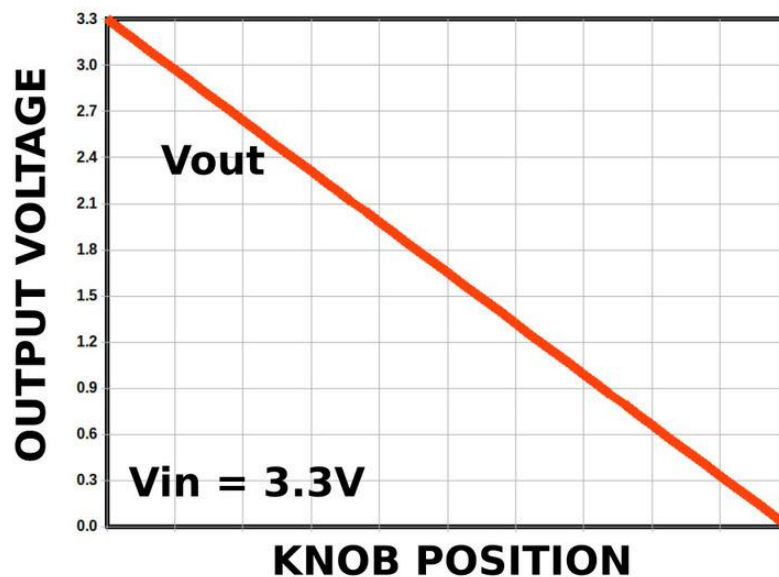

To wire up a potentiometer as a voltage divider:

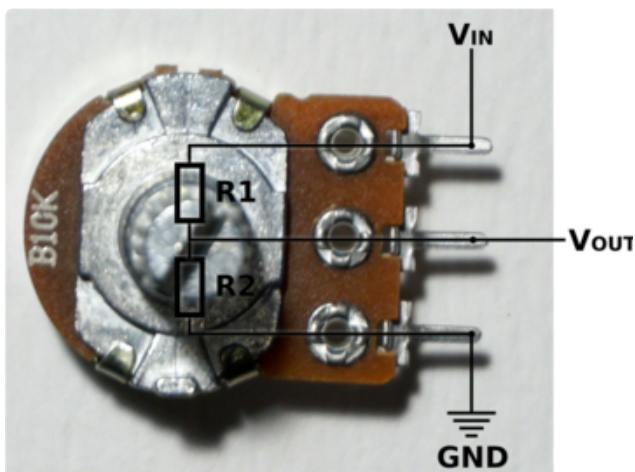

Connect one outside pin to ground
Connect the other outside pin to voltage in (e.g. 3.3V)
Connect the middle pin to an analog pin (e.g. A0)

Hardware

In addition to your microcontroller board, you will need the following hardware to follow along with this example.

Potentiometer

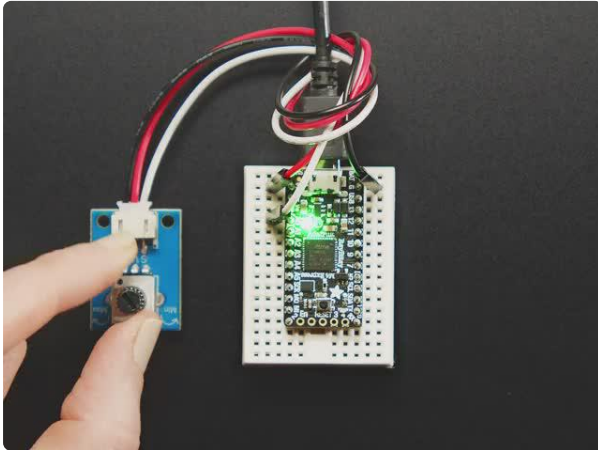

[STEMMA Wired Potentiometer Breakout Board - 10K ohm Linear](https://www.adafruit.com/product/4493)

For the easiest way possible to measure twists, turn to this STEMMA potentiometer breakout (ha!). This plug-n-play pot comes with a JST-PH 2mm connector and a matching

<https://www.adafruit.com/product/4493>

Wire Up the Potentiometer

Connect the potentiometer to your board as follows.

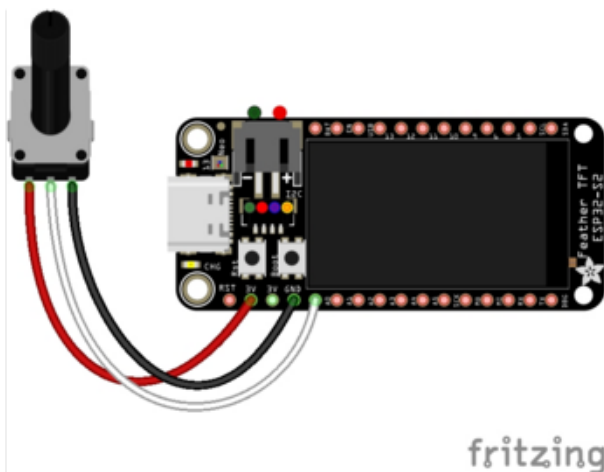

Potentiometer left pin (white wire) to Feather A0

Potentiometer center pin (red wire) to Feather 3.3V

Potentiometer right pin (black wire) to Feather GND

Reading Analog Pin Values

CircuitPython makes it easy to read analog pin values. Simply import two modules, set up the pin, and then print the value inside a loop.

You'll need to [connect to the serial console \(\)](#) to see the values printed out.

In the example below, click the Download Project Bundle button below to download the necessary libraries and the code.py file in a zip file. Extract the contents of the zip file, open the directory CircuitPython_Templates/analog_pin_values/ and then click on the directory that matches the version of CircuitPython you're using and copy the contents of that directory to your CIRCUITPY drive.

Your CIRCUITPY drive should now look similar to the following image:



```
# SPDX-FileCopyrightText: 2021 Kattni Rembor for Adafruit Industries
# SPDX-License-Identifier: MIT
"""CircuitPython analog pin value example"""
import time
import board
import analogio

analog_pin = analogio.AnalogIn(board.A0)

while True:
    print(analog_pin.value)
    time.sleep(0.1)
```

Now, rotate the potentiometer to see the values change.

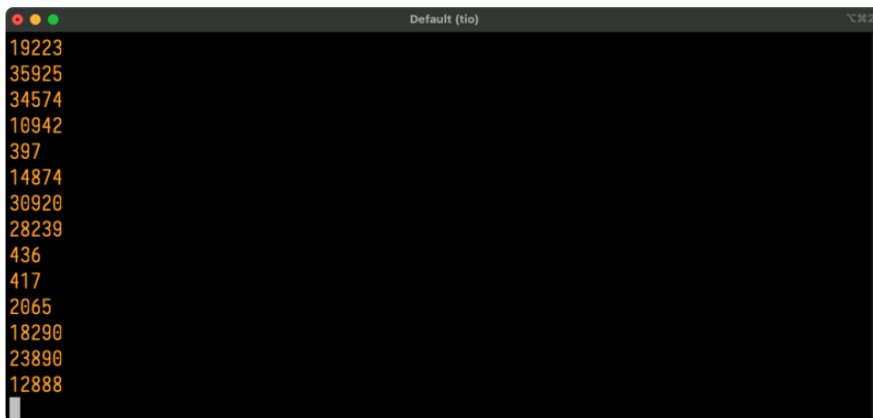

What do these values mean? In CircuitPython ADC values are put into the range of 16-bit unsigned values. This means the possible values you'll read from the ADC fall within the range of 0 to 65535 (or $2^{16} - 1$). When you twist the potentiometer knob to be near ground, or as far to the left as possible, you see a value close to zero.

When you twist it to the right, the value gets bigger up to some value that is dependent on the microcontroller. Many microcontrollers get a value very close to 65535. Some, such as the ESP32-S2, have a smaller limit of about 51000 or 2.57 volts.

The code is simple. You begin by importing three modules: `time`, `board` and `analogio`. All three modules are built into CircuitPython, so you don't need to download anything to get started.

Then, you set up the analog pin by creating an `analogio.AnalogIn()` object, providing it the desired pin using the `board` module, and saving it to the variable `analog_pin`.

Finally, in the loop, you print out the analog value with `analog_pin.value`, including a `time.sleep()` to slow down the values to a human-readable rate.

Reading Analog Voltage Values

These values don't necessarily equate to anything obvious. You can get an idea of the rotation of the potentiometer based on where in the range the value falls, but not without doing some math. Remember, you wired up the potentiometer as a voltage divider. By adding a simple function to your code, you can get a more human-readable value from the potentiometer.

You'll need to [connect to the serial console](#) () to see the values printed out.

In the example below, click the Download Project Bundle button below to download the necessary libraries and the code.py file in a zip file. Extract the contents of the zip file, open the directory `CircuitPython_Templates/analog_voltage_values_ESP32-S2/` and then click on the directory that matches the version of CircuitPython you're using and copy the contents of that directory to your CIRCUITPY drive.

Your CIRCUITPY drive should now look similar to the following image:

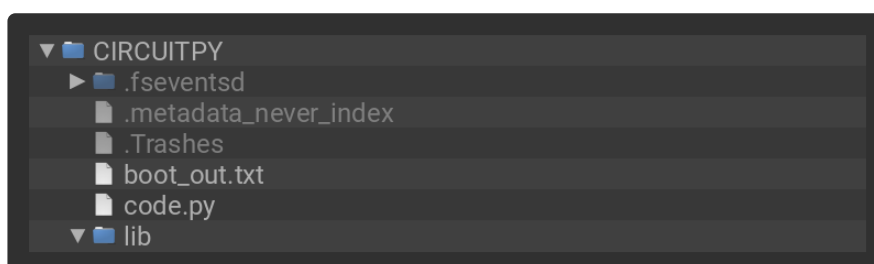

```

# SPDX-FileCopyrightText: 2022 Kattni Rembor for Adafruit Industries
# SPDX-License-Identifier: MIT
"""CircuitPython Analog In Voltage Example for ESP32-S2"""
import time
import board
import analogio

analog_pin = analogio.AnalogIn(board.A0)

def get_voltage(pin):
    return (pin.value * 2.57) / 51000

while True:
    print(get_voltage(analog_pin))
    time.sleep(0.1)

```

Now, rotate the potentiometer to see the values change.

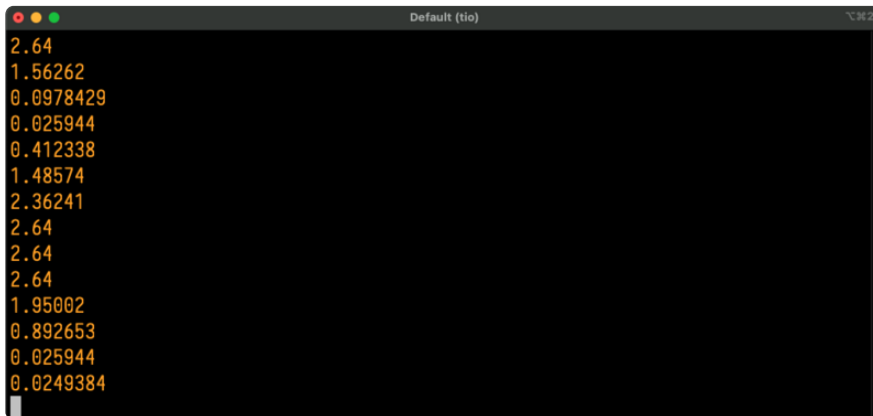

```

2.64
1.56262
0.0978429
0.025944
0.412338
1.48574
2.36241
2.64
2.64
2.64
1.95002
0.892653
0.025944
0.0249384

```

Now the values range from around 0 to 2.57! Note that due to variations in each chip, you may not get all the way to 0 or 2.57, and in some cases, you may exceed 2.57. Both of these possibilities are normal.

The example code begins with the same imports and pin setup.

This time, you include the `get_voltage` helper. This function requires that you provide an analog pin. It then maps the raw analog values, `0` to `51000`, to the voltage values, `0` to `2.57`. It does the math so you don't have to!

Finally, inside the loop, you provide the function with your `analog_pin`, and print the resulting values.

That's all there is to reading analog voltage values using CircuitPython!

NeoPixel LED

Your board has a built-in RGB NeoPixel status LED. You can use CircuitPython code to control the color and brightness of this LED. It is also used to indicate the bootloader status and errors in your CircuitPython code.

A NeoPixel is what Adafruit calls the WS281x family of addressable RGB LEDs. It contains three LEDs - a red one, a green one and a blue one - along side a driver chip in a tiny package controlled by a single pin. They can be used individually (as in the built-in LED on your board), or chained together in strips or other creative form factors. NeoPixels do not light up on their own; they require a microcontroller. So, it's super convenient that the NeoPixel is built in to your microcontroller board!

This page will cover using CircuitPython to control the status RGB NeoPixel built into your microcontroller. You'll learn how to change the color and brightness, and how to make a rainbow. Time to get started!

NeoPixel Location

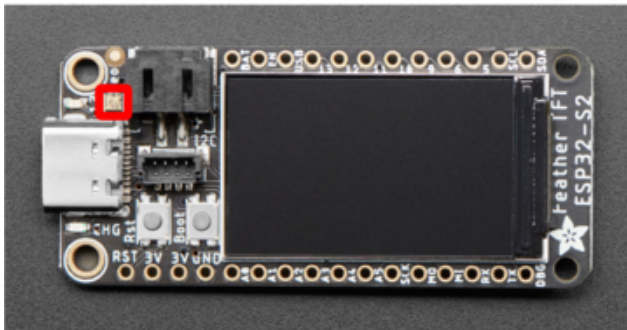

The NeoPixel (highlighted in red in the first image) is located above the USB C connector, next to the JST battery connector.

NeoPixel Color and Brightness

To use with CircuitPython, you need to first install a few libraries, into the lib folder on your CIRCUITPY drive. Then you need to update code.py with the example script.

Thankfully, we can do this in one go. In the example below, click the Download Project Bundle button below to download the necessary libraries and the code.py file in a zip file. Extract the contents of the zip file, open the directory `CircuitPython_Templates/status_led_one_neopixel_rgb/` and then click on the directory that matches the

version of CircuitPython you're using and copy the contents of that directory to your CIRCUITPY drive.

Your CIRCUITPY drive should now look similar to the following image:

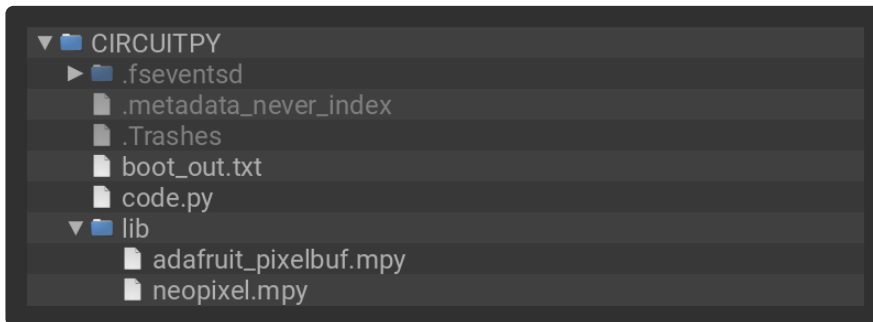

```
# SPDX-FileCopyrightText: 2021 Kattni Rembor for Adafruit Industries
# SPDX-License-Identifier: MIT
"""CircuitPython status NeoPixel red, green, blue example."""
import time
import board
import neopixel

pixel = neopixel.NeoPixel(board.NEOPIXEL, 1)

pixel.brightness = 0.3

while True:
    pixel.fill((255, 0, 0))
    time.sleep(0.5)
    pixel.fill((0, 255, 0))
    time.sleep(0.5)
    pixel.fill((0, 0, 255))
    time.sleep(0.5)
```

The built-in NeoPixel begins blinking red, then green, then blue, and repeats!



First you import two modules, `time` and `board`, and one library, `neopixel`. This makes these modules and libraries available for use in your code. The first two are modules built-in to CircuitPython, so you don't need to download anything to use those. The `neopixel` library is separate, which is why you needed to install it before getting started.

Next, you set up the NeoPixel LED. To interact with hardware in CircuitPython, your code must let the board know where to look for the hardware and what to do with it. So, you create a `neopixel.NeoPixel()` object, provide it the NeoPixel LED pin using the `board` module, and tell it the number of LEDs. You save this object to the variable `pixel`.

Then, you set the NeoPixel brightness using the `brightness` attribute. `brightness` expects float between `0` and `1.0`. A float is essentially a number with a decimal in it. The brightness value represents a percentage of maximum brightness; `0` is 0% and `1.0` is 100%. Therefore, setting `pixel.brightness = 0.3` sets the brightness to 30%. The default brightness, which is to say the brightness if you don't explicitly set it, is `1.0`. The default is really bright! That is why there is an option available to easily change the brightness.

Inside the loop, you turn the NeoPixel red for 0.5 seconds, green for 0.5 seconds, and blue for 0.5 seconds.

To turn the NeoPixel red, you "fill" it with an RGB value. Check out the section below for details on RGB colors. The RGB value for red is `(255, 0, 0)`. Note that the RGB value includes the parentheses. The `fill()` attribute expects the full RGB value including those parentheses. That is why there are two pairs of parentheses in the code.

You can change the RGB values to change the colors that the NeoPixel cycles through. Check out the list below for some examples. You can make any color of the rainbow with the right RGB value combination!

That's all there is to changing the color and setting the brightness of the built-in NeoPixel LED!

RGB LED Colors

RGB LED colors are set using a combination of red, green, and blue, in the form of an (R, G, B) tuple. Each member of the tuple is set to a number between 0 and 255 that determines the amount of each color present. Red, green and blue in different

combinations can create all the colors in the rainbow! So, for example, to set an LED to red, the tuple would be `(255, 0, 0)`, which has the maximum level of red, and no green or blue. Green would be `(0, 255, 0)`, etc. For the colors between, you set a combination, such as cyan which is `(0, 255, 255)`, with equal amounts of green and blue. If you increase all values to the same level, you get white! If you decrease all the values to 0, you turn the LED off.

Common colors include:

- red: `(255, 0, 0)`
- green: `(0, 255, 0)`
- blue: `(0, 0, 255)`
- cyan: `(0, 255, 255)`
- purple: `(255, 0, 255)`
- yellow: `(255, 255, 0)`
- white: `(255, 255, 255)`
- black (off): `(0, 0, 0)`

NeoPixel Rainbow

You should have already installed the library necessary to use the built-in NeoPixel LED. If not, follow the steps at the beginning of the NeoPixel Color and Brightness section to install it.

In the example below, click the Download Project Bundle button below to download the necessary libraries and the code.py file in a zip file. Extract the contents of the zip file, open the directory `CircuitPython_Templates/status_led_one_neopixel_rainbow/` and then click on the directory that matches the version of CircuitPython you're using and copy the contents of that directory to your CIRCUITPY drive.

Your CIRCUITPY drive should now look similar to the following image:

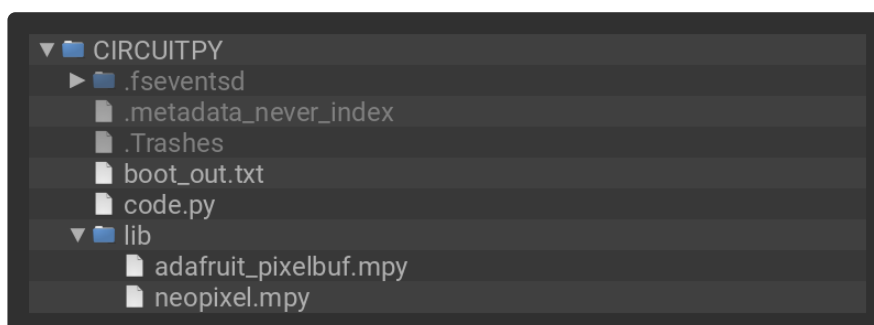

```

# SPDX-FileCopyrightText: 2021 Kattni Rembor for Adafruit Industries
# SPDX-License-Identifier: MIT
"""CircuitPython status NeoPixel rainbow example."""
import time
import board
from rainbowio import colorwheel
import neopixel

pixel = neopixel.NeoPixel(board.NEOPIXEL, 1)
pixel.brightness = 0.3

def rainbow(delay):
    for color_value in range(255):
        pixel[0] = colorwheel(color_value)
        time.sleep(delay)

while True:
    rainbow(0.02)

```

The NeoPixel displays a rainbow cycle!

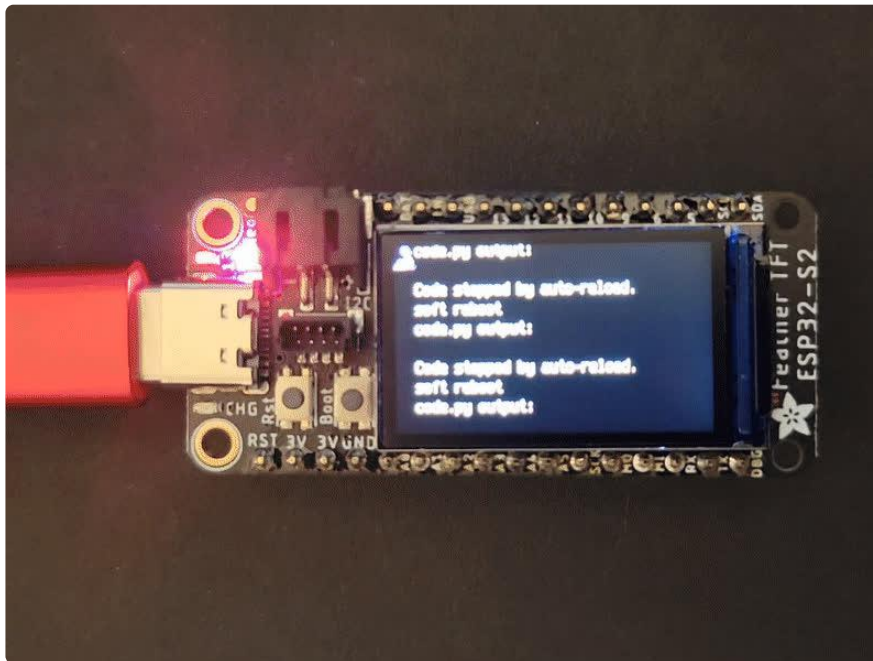

This example builds on the previous example.

First, you import the same three modules and libraries. In addition to those, you import `colorwheel`.

The NeoPixel hardware setup and brightness setting are the same.

Next, you have the `rainbow()` helper function. This helper displays the rainbow cycle. It expects a `delay` in seconds. The higher the number of seconds provided for

`delay`, the slower the rainbow will cycle. The helper cycles through the values of the color wheel to create a rainbow of colors.

Inside the loop, you call the rainbow helper with a 0.2 second delay, by including `rainbow(0.2)`.

That's all there is to making rainbows using the built-in NeoPixel LED!

Digital Input

The CircuitPython `digitalio` module has many applications. The basic Blink program sets up the LED as a digital output. You can just as easily set up a digital input such as a button to control the LED. This example builds on the basic Blink example, but now includes setup for a button switch. Instead of using the `time` module to blink the LED, it uses the status of the button switch to control whether the LED is turned on or off.

LED and Button

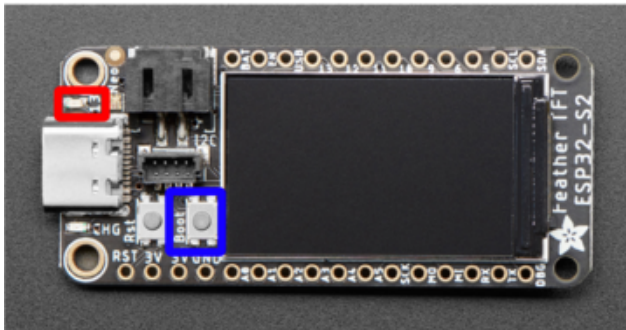

The red LED is located above the USB C connector, below the mounting hole, on the left end of the board.

The Boot button is located between the reset button and the TFT display. It is labeled Boot on the silk.

Controlling the LED with a Button

In the example below, click the Download Project Bundle button below to download the necessary libraries and the code.py file in a zip file. Extract the contents of the zip file, open the directory `CircuitPython_Templates/digital_input_built_in_button_led/` and then click on the directory that matches the version of CircuitPython you're using and copy the contents of that directory to your CIRCUITPY drive.

Your CIRCUITPY drive should now look similar to the following image:

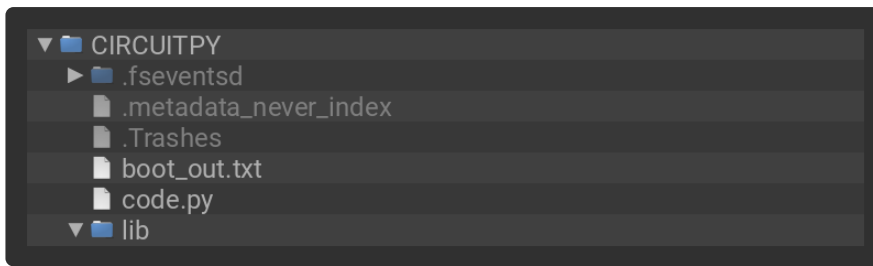

```
# SPDX-FileCopyrightText: 2022 Kattni Rembor for Adafruit Industries
# SPDX-License-Identifier: MIT
"""
CircuitPython Digital Input Example - Blinking an LED using the built-in button.
"""
import board
import digitalio

led = digitalio.DigitalInOut(board.LED)
led.direction = digitalio.Direction.OUTPUT

button = digitalio.DigitalInOut(board.BUTTON)
button.switch_to_input(pull=digitalio.Pull.UP)

while True:
    if not button.value:
        led.value = True
    else:
        led.value = False
```

Now, press the button. The LED lights up! Let go of the button and the LED turns off.

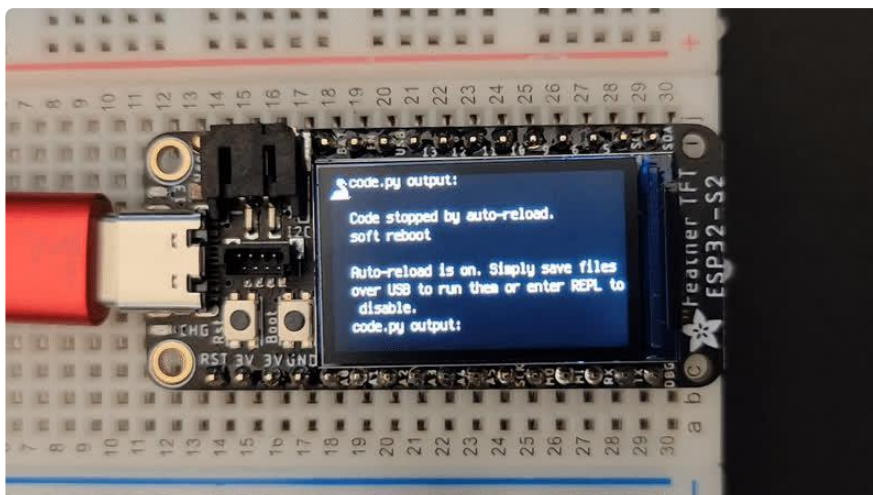

Note that the code is a little less "Pythonic" than it could be. It could also be written as `led.value = not button.value`. That way is more difficult to understand if you're new to programming, so the example is a bit longer than it needed to be to make it easier to read.

First you `import` two modules: `board` and `digitalio`. This makes these modules available for use in your code. Both are built-in to CircuitPython, so you don't need to download anything to get started.

Next, you set up the LED. To interact with hardware in CircuitPython, your code must let the board know where to look for the hardware and what to do with it. So, you create a `digitalio.DigitalInOut()` object, provide it the LED pin using the `board` module, and save it to the variable `led`. Then, you tell the pin to act as an `OUTPUT`.

You include setup for the button as well. It is similar to the LED setup, except the button is an `INPUT`, and requires a pull up.

Inside the loop, you check to see if the button is pressed, and if so, turn on the LED. Otherwise the LED is off.

That's all there is to controlling an LED with a button switch!

Storage

CircuitPython-compatible microcontrollers show up as a CIRCUIPTY drive when plugged into your computer, allowing you to edit code directly on the board. Perhaps you've wondered whether or not you can write data from CircuitPython directly to the board to act as a data logger. The answer is yes!

The `storage` module in CircuitPython enables you to write code that allows CircuitPython to write data to the CIRCUIPTY drive. This process requires you to include a `boot.py` file on your CIRCUIPTY drive, along side your `code.py` file.

The `boot.py` file is special - the code within it is executed when CircuitPython starts up, either from a hard reset or powering up the board. It is not run on soft reset, for example, if you reload the board from the serial console or the REPL. This is in contrast to the code within `code.py`, which is executed after CircuitPython is already running.

The CIRCUIPTY drive is typically writable by your computer; this is what allows you to edit your code directly on the board. The reason you need a `boot.py` file is that you have to set the filesystem to be read-only by your computer to allow it to be writable by CircuitPython. This is because CircuitPython cannot write to the filesystem at the same time as your computer. Doing so can lead to filesystem corruption and loss of all content on the drive, so CircuitPython is designed to only allow one at a time.

You can only have EITHER your computer edit files on the CIRCUITPY drive, OR have CircuitPython edit files. You cannot have both writing to the CIRCUITPY drive at the same time. CircuitPython doesn't allow it!

The boot.py File

The filesystem will NOT automatically be set to read-only on creation of this file! You'll still be able to edit files on CIRCUITPY after saving this boot.py.

```
# SPDX-FileCopyrightText: 2021 Kattni Rembor for Adafruit Industries
# SPDX-License-Identifier: MIT
"""
CircuitPython Essentials Storage CP Filesystem boot.py file
"""
import time
import board
import digitalio
import storage
import neopixel

pixel = neopixel.NeoPixel(board.NEOPIXEL, 1)

button = digitalio.DigitalInOut(board.BUTTON)
button.switch_to_input(pull=digitalio.Pull.UP)

# Turn the NeoPixel white for one second to indicate when to press the boot button.
pixel.fill((255, 255, 255))
time.sleep(1)

# If the button is connected to ground, the filesystem is writable by CircuitPython
storage.remount("/", readonly=button.value)
```

The `storage.remount()` command has a `readonly` keyword argument. This argument refers to the read/write state of CircuitPython. It does NOT refer to the read/write state of your computer.

When the button is pressed, it returns `False`. The `readonly` argument in `boot.py` is set to the `value` of the button. When the `value=True`, the CIRCUITPY drive is read-only to CircuitPython (and writable by your computer). When the `value=False`, the CIRCUITPY drive is writable by CircuitPython (and read-only by your computer).

The code.py File

Save the following as `code.py` on your CIRCUITPY drive.

In the example below, click the Download Project Bundle button below to download the necessary libraries and the `code.py` file in a zip file. Extract the contents of the zip

file, open the directory `Adafruit_Feather_TFT_ESP32-S2/storage/` and then click on the directory that matches the version of CircuitPython you're using and copy the contents of that directory to your CIRCUITPY drive.

Your CIRCUITPY drive should now look similar to the following image:

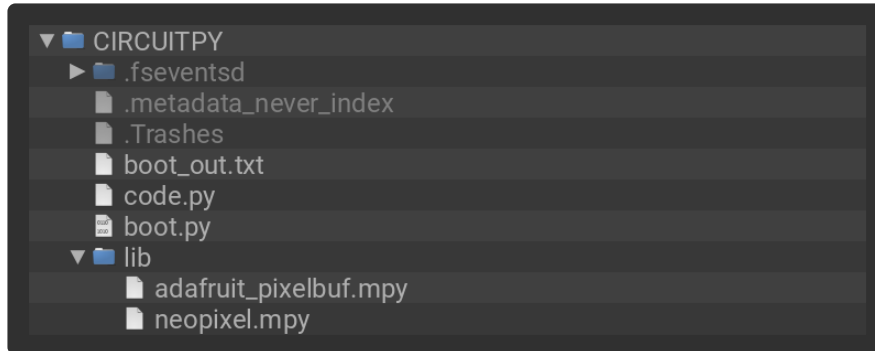

```
# SPDX-FileCopyrightText: 2021 Kattni Rembor for Adafruit Industries
# SPDX-License-Identifier: MIT
"""
CircuitPython Essentials Storage CP Filesystem code.py file
For use with boards with a built-in red LED.
"""
import time
import board
import digitalio
import microcontroller

led = digitalio.DigitalInOut(board.LED)
led.switch_to_output()

try:
    with open("/temperature.txt", "a") as temp_log:
        while True:
            # The microcontroller temperature in Celsius. Include the
            # math to do the C to F conversion here, if desired.
            temperature = microcontroller.cpu.temperature

            # Write the temperature to the temperature.txt file every 10 seconds.
            temp_log.write('{0:.2f}\n'.format(temperature))
            temp_log.flush()

            # Blink the LED on every write...
            led.value = True
            time.sleep(1) # ...for one second.
            led.value = False # Then turn it off...
            time.sleep(9) # ...for the other 9 seconds.

except OSError as e: # When the filesystem is NOT writable by CircuitPython...
    delay = 0.5 # ...blink the LED every half second.
    if e.args[0] == 28: # If the file system is full...
        delay = 0.15 # ...blink the LED every 0.15 seconds!
    while True:
        led.value = not led.value
        time.sleep(delay)
```

First you import the necessary modules to make them available to your code, and you set up the LED.

Next you have a `try / except` block, which is used to handle the three potential states of the board: read/write, read-only, or filesystem full. The code in the `try` block will run if the filesystem is writable by CircuitPython. The code in the `except` block will run if the filesystem is read-only to CircuitPython OR if the filesystem is full.

Under the `try`, you open a `temperature.txt` log file. If it is the first time, it will create the file. For all subsequent times, it opens the file and appends data. Inside the loop, you get the microcontroller temperature value and assign it to a `temperature` variable. Then, you write the temperature value to the log file, followed by clearing the buffer for the next time through the loop. The temperature data is limited to two decimal points to save space for more data. Finally, you turn the LED on for one second, and then turn it off for the next nine seconds. Essentially, you blink the LED for one second every time the temperature is logged to the file which happens every ten seconds.

Next you `except` an `OSError`. An `OSError` number 30 is raised when trying to create, open or write to a file on a filesystem that is read-only to CircuitPython. If any `OSError` other than 28 is raised (e.g. 30), the `delay` is set to 0.5 seconds. If the filesystem fills up, CircuitPython raises `OSError` number 28. If `OSError` number 28 is raised, the `delay` is set to 0.15 seconds. Inside the loop, the LED is turned on for the duration of the `delay`, and turned off for the duration of the `delay`, effectively blinking the LED at the speed of the `delay`.

Logging the Temperature

At the moment, the LED on your board should be blinking once every half second. This indicates that the board is currently read-only to CircuitPython, and writable to your computer, allowing you to update the files on your CIRCUITPY drive as needed.

The way the code in `boot.py` works is, it checks to see if the button is pressed when the board is powered on and `boot.py` is run. To begin logging the temperature, you must press the button.

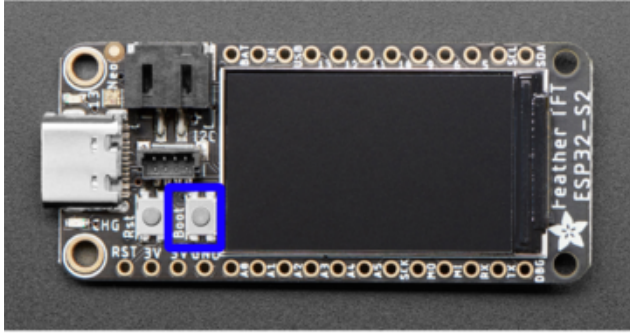

The boot button (highlighted in blue) is between the reset button and the TFT display. It is labeled Boot on the silk.

While holding down the button, you need to either hard reset the board by pressing the reset button, or by unplugging the USB cable and plugging it back in. This will run the code within `boot.py` and set your board to writable by CircuitPython, and therefore, read-only by the computer.

For the Feather TFT, the button-press timing is a little different. Press it when the NeoPixel LED turns white!

For the Feather TFT, it's difficult to get the timing right for when to press the boot button. So, the `boot.py` file includes turning the NeoPixel on bright white for one second. Press the boot button when the NeoPixel is white!

The red blinking will slow down to one second long, every 10 seconds. This indicates that the board is currently logging the temperature, once every 10 seconds.

As long as the button is pressed, you can plug the board in anywhere you have USB power, and log the temperature in that location! The temperature is not the ambient temperature; it is the temperature inside the microcontroller, which will typically be higher than ambient temperature. However, running only this code, once the microcontroller temperature stabilises, it should at least be consistent, and therefore usable for tracking changes in ambient temperature.

If the LED starts blinking really quickly, it means the filesystem is full! You'll need to get your temperature data and delete the temperature log file to begin again.

That's all there is to logging the temperature using CircuitPython!

Recovering a Read-Only Filesystem

In the event that you make your CIRCUITPY drive read-only to your computer, and for some reason, it doesn't easily switch back to writable, there are a couple of things you can do to recover the filesystem.

Even when the CIRCUITPY drive is read-only to your computer, you can still access the serial console and REPL. If you connect to the serial console and enter the REPL, you can run either of the following two sets of commands at the `>>>` prompt. You do not need to run both.

First, you can rename your `boot.py` file to something other than `boot.py`.

```
import os
os.rename("boot.py", "something_else.py")
```

Alternatively, you can remove the `boot.py` file altogether.

```
import os
os.remove("boot.py")
```

Then, restart the board by either hitting the reset button or unplugging USB and plugging it back in. CIRCUITPY should show up on your computer as usual, but now it should be writable by your computer.

Capacitive Touch

Your microcontroller board has capacitive touch capabilities on multiple pins. The CircuitPython `touchio` module makes it simple to detect when you touch a pin, enabling you to use it as an input.

This section first covers using the `touchio` module to read touches on one pin. You'll learn how to setup the pin in your program, and read the touch status. Then, you'll learn how to read touches on multiple pins in a single example. Time to get started!

One Capacitive Touch Pin

The first example covered here will show you how to read touches on one pin.

Pin Location

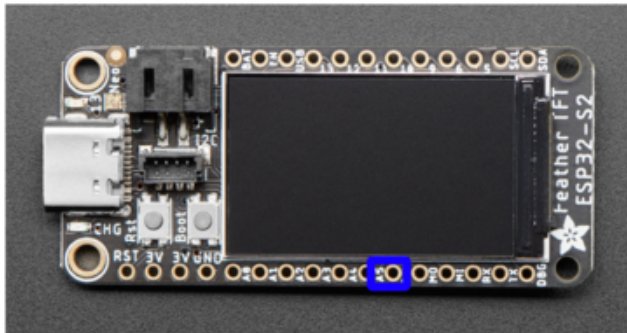

The D5 pin (highlighted in blue) is located along the bottom edge of the board, between A4 and SCK. It is labeled A5 on the silk (the pin has multiple name options).

Reading Touch on the Pin

In the example below, click the Download Project Bundle button below to download the necessary libraries and the code.py file in a zip file. Extract the contents of the zip file, open the directory CircuitPython_Templates/cap_touch_one_pin_ESP32-S2/ and then click on the directory that matches the version of CircuitPython you're using and copy the contents of that directory to your CIRCUITPY drive.

Your CIRCUITPY drive should now look similar to the following image:

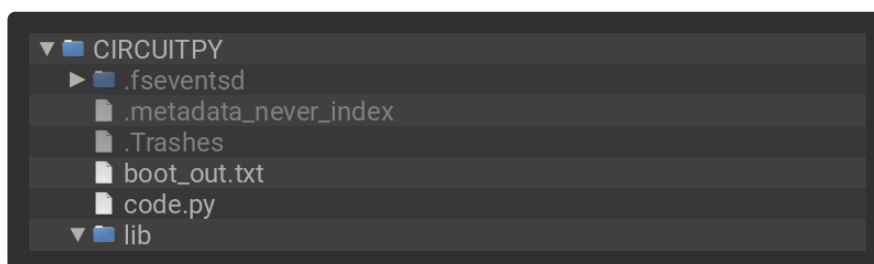

Then, [connect to the serial console \(\)](#).

```
# SPDX-FileCopyrightText: 2021 Kattni Rembor for Adafruit Industries
# SPDX-License-Identifier: MIT
"""
CircuitPython Capacitive Touch Pin Example for ESP32-S2.
Print to the serial console when one pin is touched.
"""
import time
import board
import touchio

touch = touchio.TouchIn(board.D8)

while True:
    if touch.value:
```



```
print("Pin touched!")
time.sleep(0.1)
```

Touch is designed to calibrate on board startup. In some cases, the ESP32-S2 does not calibrate properly, and the board running this code will report the pin as "touched" when you are not touching it. You can update the threshold manually in these cases to resolve this issue. See the end of this page for details.

Now touch the pin indicated in the diagram above. You'll see `Pin touched!` printed to the serial console!

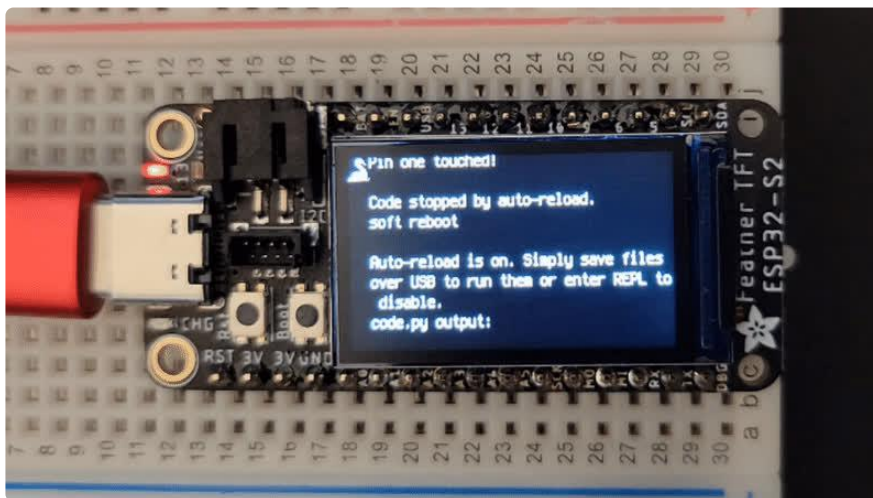

First you `import` three modules: `time`, `board` and `touchio`. This makes these modules available for use in your code. All three are built-in to CircuitPython, so you don't find any library files in the Project Bundle.

Next, you create the `touchio.TouchIn()` object, and provide it the pin name using the `board` module. You save that to the `touch` variable.

Inside the loop, you check to see if the pin is touched. If so, you print to the serial console. Finally, you include a `time.sleep()` to slow it down a bit so the output is readable.

That's all there is to reading touch on a single pin using `touchio` in CircuitPython!

Multiple Capacitive Touch Pins

The next example shows you how to read touches on multiple pins in a single program.

Pin Location

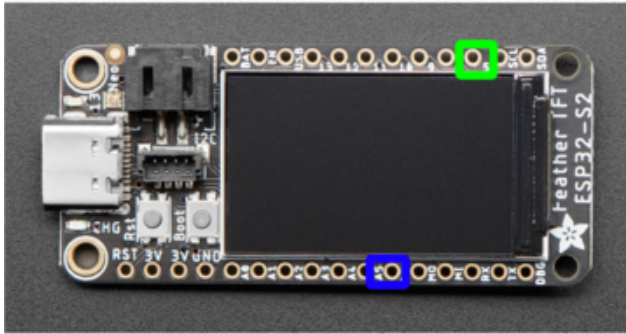

The A5 pin (highlighted in blue) is located along the bottom edge of the board, between A4 and SCK. It is labeled A5 on the silk.

The D5 pin (highlighted in green) is located along the top edge of the board, between D6 and SCL. It is labeled 5 on the silk.

Reading Touch on the Pins

In the example below, click the Download Project Bundle button below to download the necessary libraries and the code.py file in a zip file. Extract the contents of the zip file, open the directory `CircuitPython_Templates/cap_touch_two_pins_ESP32-S2/` and then click on the directory that matches the version of CircuitPython you're using and copy the contents of that directory to your CIRCUITPY drive.

Your CIRCUITPY drive should now look similar to the following image:

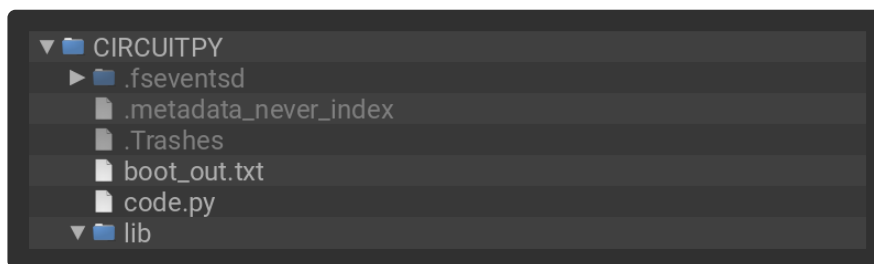

Then, [connect to the serial console \(\)](#).

```
# SPDX-FileCopyrightText: 2021 Kattni Rembor for Adafruit Industries
# SPDX-License-Identifier: MIT
"""
CircuitPython Capacitive Two Touch Pin Example for ESP32-S2
Print to the serial console when a pin is touched.
"""
import time
import board
import touchio

touch_one = touchio.TouchIn(board.D8)
touch_two = touchio.TouchIn(board.D5)

while True:
```

```
if touch_one.value:
    print("Pin one touched!")
if touch_two.value:
    print("Pin two touched!")
time.sleep(0.1)
```

Touch is designed to calibrate on board startup. In some cases, the ESP32-S2 does not calibrate properly, and the board running this code will report the pins as "touched" when you are not touching them. You can update the threshold manually in these cases to resolve this issue. See the end of this page for details.

Touch the pins to see the messages printed to the serial console!

This example builds on the first. The imports remain the same.

The `touchio.TouchIn()` object is created, but is instead saved to `touch_one`. A second `touchio.TouchIn()` object is also created, the second pin is provided to it using the `board` module, and is saved to `touch_two`.

Inside the loop, we check to see if pin one and pin two are touched, and if so, print to the serial console `Pin one touched!` and `Pin two touched!`, respectively. The same `time.sleep()` is included.

If more touch-capable pins are available on your board, you can easily add them by expanding on this example!

The Available Touch-Capable Pins

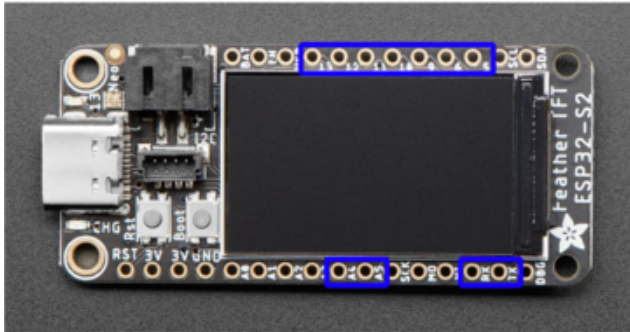

- A4 - CircuitPython `board.A4` . Arduino `14` .
- A5 - CircuitPython `board.A5` . Arduino `8` .
- TX - CircuitPython `board.TX` . Arduino `1` .
- RX - CircuitPython `board.RX` . Arduino `2` .
- D13 - CircuitPython `board.D13` . Arduino `13` .
- D12 - CircuitPython `board.D12` . Arduino `12` .
- D11 - CircuitPython `board.D11` . Arduino `11` .
- D10 - CircuitPython `board.D10` . Arduino `10` .
- D9 - CircuitPython `board.D9` . Arduino `9` .
- D6 - CircuitPython `board.D6` . Arduino `6` .
- D5 - CircuitPython `board.D5` . Arduino `5` .

Setting Touch Threshold Manually

In some cases, the ESP32-S2 fails to calibrate the touch threshold properly on board startup. In those cases, the board running this code will show the pin as touched (printed in the serial console) when you are not touching it. In this event, you can set the threshold manually. Setting the threshold manually involves two steps: obtaining the current touch `threshold` and `raw_value`, and setting the `threshold` once that information is known.

First, add the following to your code inside the loop (after the `while True:` which is included below for reference). The following code works exactly as-is for the one-pin example. Duplicate these two lines, and update `touch` to `touch_one` and `touch_two` for the two-pin example.

```
while True:
    print("Raw value: ", touch.raw_value)
    print("Threshold: ", touch.threshold)
```

Now, if you haven't already, connect to the serial console. You will see two new lines of information printed out. Make a mental note of what the current threshold is. The more important piece of information is the raw value. Note what the value is when you are not touching the pin. Now, touch the pin, and make a note of that value. The value

you choose for updating `threshold` should be higher than when you are not touching the pin, and lower than when you are.

Once you've chosen your value, you can delete the lines you added above. Then, add the following line of code BEFORE the loop, but after the touch object is created. Replace `NEW_VALUE` with the value you chose based on the data provided. Again, for use with the two-pin example, duplicate these two lines, and update `touch` to `touch_one` and `touch_two`.

```
touch.threshold = NEW_VALUE
```

Now, your board should automatically reload, and you should see nothing printed to the serial console. Try touching the pin. `Pin touched!`

If you're still seeing it printing to the serial console when not touched, try changing the `threshold` value to something higher than you currently have.

That's all there is to manually setting the threshold for a touch pin!

CPU Temperature

There is a temperature sensor built into the CPU on your microcontroller board. It reads the internal CPU temperature, which varies depending on how long the board has been running or how intense your code is.

CircuitPython makes it really simple to read this data from the temperature sensor built into the microcontroller. Using the built-in `microcontroller` module, you can easily read the temperature.

Microcontroller Location

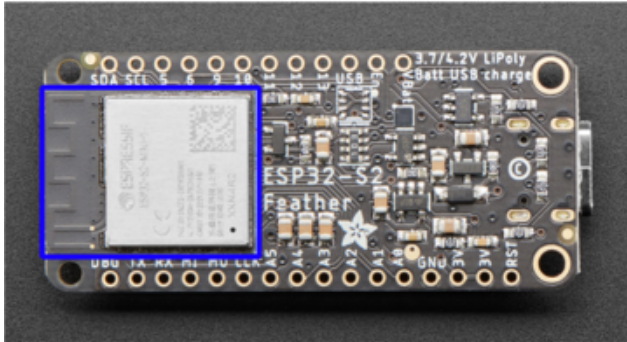

The ESP32-S2 microcontroller (highlighted in blue) is located on the bottom of the board, opposite the USB C connector.

Reading the Microcontroller Temperature

The data is read using two lines of code. All necessary modules are built into CircuitPython, so you don't need to download any extra files to get started.

[Connect to the serial console \(\)](#), and then update your code.py to the following.

In the example below, click the Download Project Bundle button below to download the necessary libraries and the code.py file in a zip file. Extract the contents of the zip file, open the directory CircuitPython_Templates/cpu_temperature/ and then click on the directory that matches the version of CircuitPython you're using and copy the contents of that directory to your CIRCUITPY drive.

Your CIRCUITPY drive should now look similar to the following image:

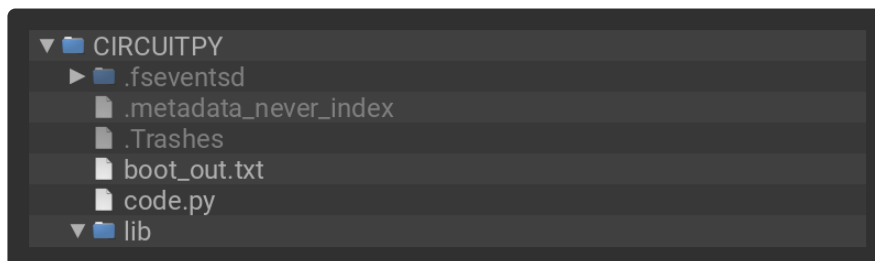

```
# SPDX-FileCopyrightText: 2021 Kattni Rembor for Adafruit Industries
# SPDX-License-Identifier: MIT
"""CircuitPython CPU temperature example in Celsius"""
import time
import microcontroller

while True:
```

```
print(microcontroller.cpu.temperature)
time.sleep(0.15)
```

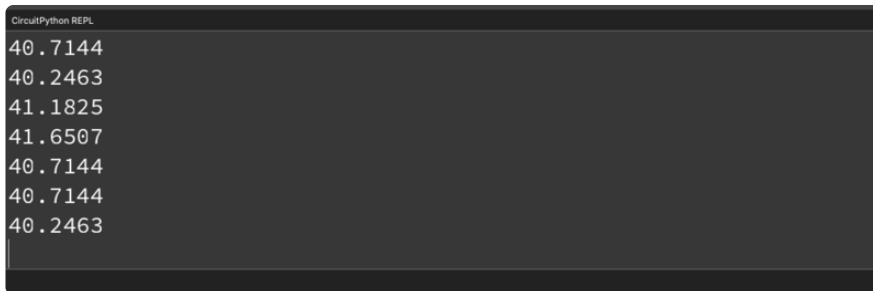

```
CircuitPython REPL
40.7144
40.2463
41.1825
41.6507
40.7144
40.7144
40.2463
```

The CPU temperature in Celsius is printed out to the serial console!

Try putting your finger on the microcontroller to see the temperature change.

The code is simple. First you import two modules: `time` and `microcontroller`. Then, inside the loop, you print the microcontroller CPU temperature, and the `time.sleep()` slows down the print enough to be readable. That's it!

You can easily print out the temperature in Fahrenheit by adding a little math to your code, using this simple formula: Celsius * (9/5) + 32.

In the example below, click the Download Project Bundle button below to download the necessary libraries and the code.py file in a zip file. Extract the contents of the zip file, open the directory `CircuitPython_Templates/cpu_temperature_f/` and then click on the directory that matches the version of CircuitPython you're using and copy the contents of that directory to your CIRCUITPY drive.

Your CIRCUITPY drive should now look similar to the following image:

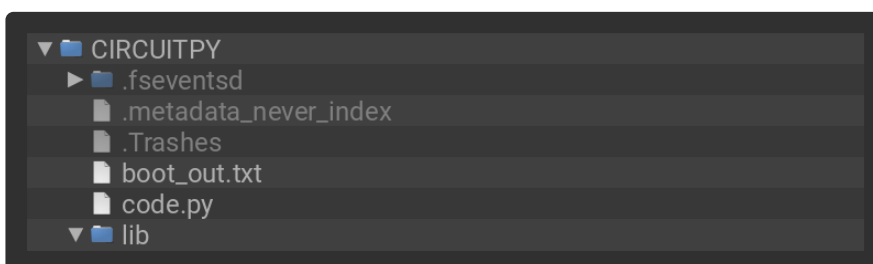

```
# SPDX-FileCopyrightText: 2021 Kattni Rembor for Adafruit Industries
# SPDX-License-Identifier: MIT
"""CircuitPython CPU temperature example in Fahrenheit"""
import time
import microcontroller

while True:
    print(microcontroller.cpu.temperature * (9 / 5) + 32)
    time.sleep(0.15)
```

```
CircuitPython REPL
104.443
104.443
105.286
104.443
106.971
101.915
103.601
```

The CPU temperature in Fahrenheit is printed out to the serial console!

That's all there is to reading the CPU temperature using CircuitPython!

Arduino IDE Setup

The ESP32-S2/S3 bootloader does not have USB serial support for Windows 7 or 8. (See <https://github.com/espressif/arduino-esp32/issues/5994>) please update to version 10 which is supported by espressif! Alternatively you can try this community-crafted Windows 7 driver (<https://github.com/kutukvpavel/Esp32-Win7-VCP-drivers>)

The first thing you will need to do is to download the latest release of the Arduino IDE. You will need to be using version 1.8 or higher for this guide

[Arduino IDE Download](#)

The ESP32-S2/S3 Arduino board support package is currently part of the 2.0.0 or later release. To use the ESP32-S2/S3 with Arduino, you'll need to follow the steps below for your operating system. You can also [check out the Espressif Arduino repository for the most up to date details on how to install it \(\)](#).

After you have downloaded and installed the latest version of Arduino IDE, you will need to start the IDE and navigate to the Preferences menu. You can access it from the File menu in Windows or Linux, or the Arduino menu on OS X.

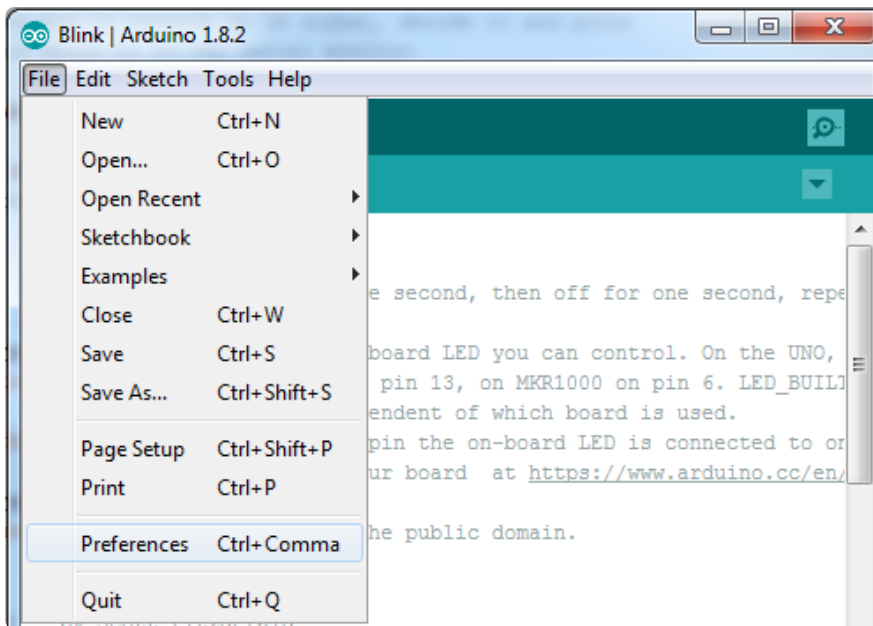

A dialog will pop up just like the one shown below.

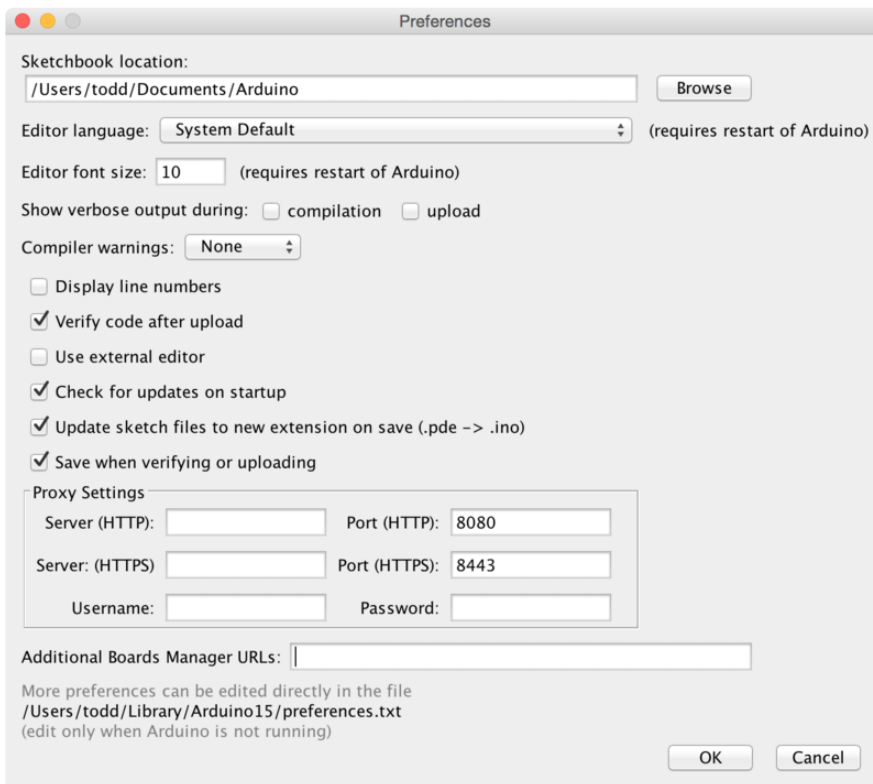

We will be adding a URL to the new Additional Boards Manager URLs option. The list of URLs is comma separated, and you will only have to add each URL once. New Adafruit boards and updates to existing boards will automatically be picked up by the Board Manager each time it is opened. The URLs point to index files that the Board Manager uses to build the list of available & installed boards.

To find the most up to date list of URLs you can add, you can visit the list of [third party board URLs on the Arduino IDE wiki](#) (). We will only need to add one URL to the IDE in this example, but you can add multiple URLs by separating them with commas. Copy and paste the link below into the Additional Boards Manager URLs option in the Arduino IDE preferences.

https://raw.githubusercontent.com/espressif/arduino-esp32/gh-pages/package_esp32_dev_index.json

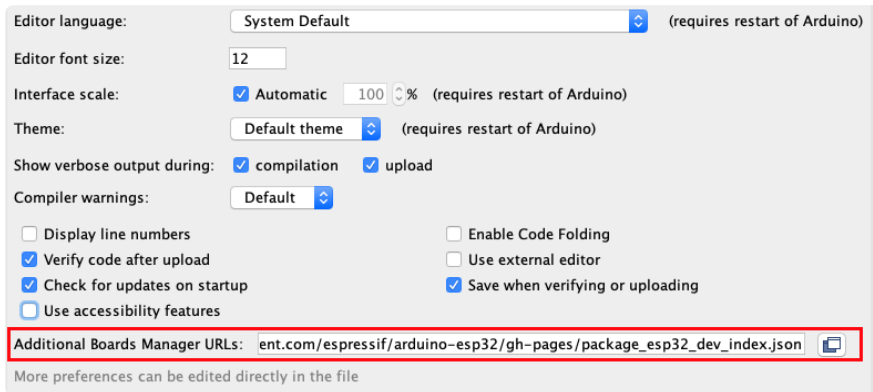

If you have multiple boards you want to support, say ESP8266 and Adafruit, have both URLs in the text box separated by a comma (,)

Once done click OK to save the new preference settings.

The next step is to actually install the Board Support Package (BSP). Go to the Tools → Board → Board Manager submenu. A dialog should come up with various BSPs. Search for esp32.

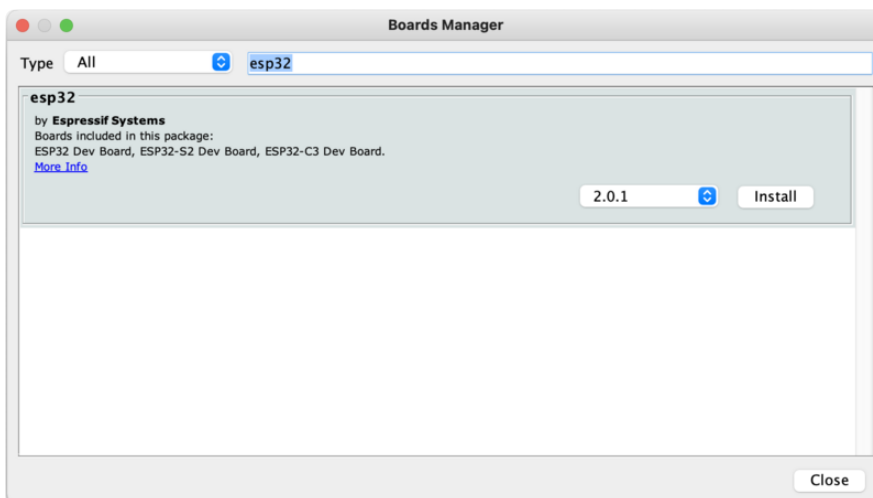

Click the Install button and wait for it to finish. Once it is finished, you can close the dialog.

In the Tools → Board submenu you should see ESP32 Arduino and in that dropdown it should contain the ESP32 boards along with all the latest ESP32-S2/S3 boards.

Look for the board called Adafruit Feather ESP32-S2 TFT.

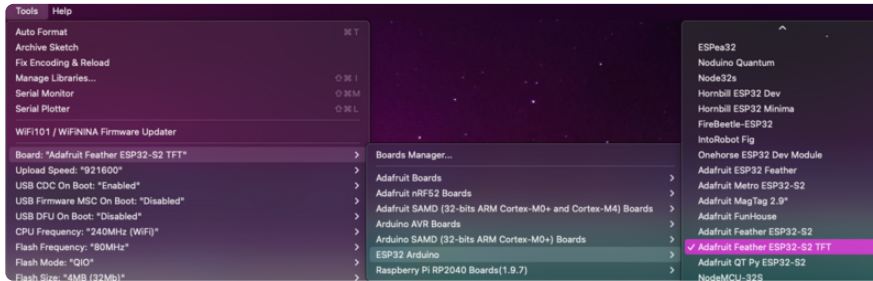

Using with Arduino IDE

Blink

Now you can upload your first blink sketch!

Plug in the ESP32-S2/S3 board and wait for it to be recognized by the OS (just takes a few seconds).

Select ESP32-S2/S3 Board in Arduino IDE

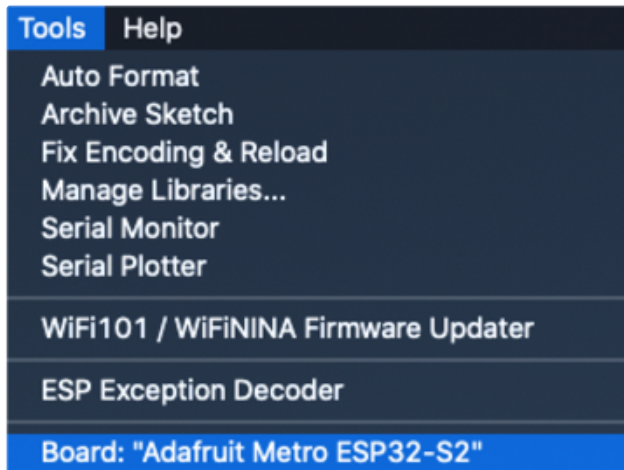

On the Arduino IDE, click:

Tools -> Board -> ESP32 Arduino -> Your Adafruit ESP32-S2/S3 board

The screenshot shows Metro S2 but you may have a different board. Make sure the name matches the exact product you purchased. If you don't see your board, make sure you have the latest version of the ESP32 board support package

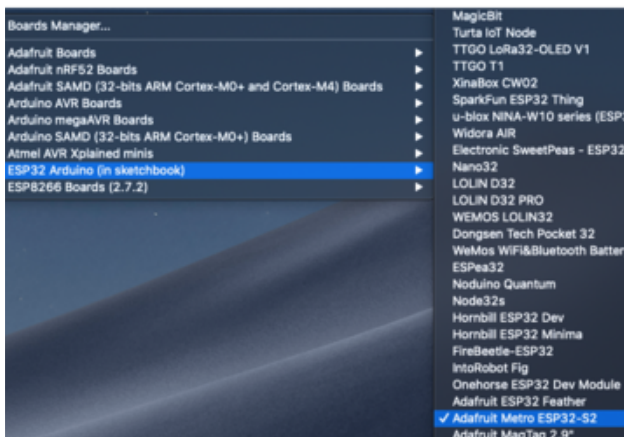

Launch ESP32-S2/S3 ROM Bootloader

ESP32-S2/S3 support in Arduino uses native USB which can crash. If you ever DON'T see a serial/COM port, you can always manually enter bootloading mode. This bootloader is in ROM, it is 'un-brickable' so you can always use this technique to get into the bootloader. However, after uploading your Arduino code you MUST press reset to start the sketch

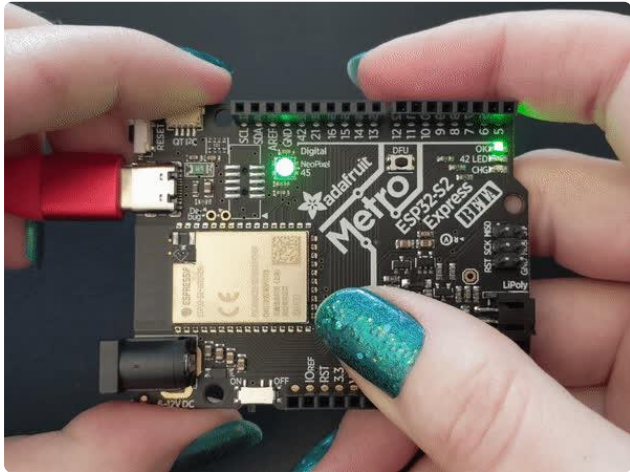

Before we upload a sketch, [place your ESP32-S2/S3 board into ROM bootloader mode \(\)](#).

Look for the Reset button and a second DFU / BOOT0 button

HOLD down the DFU/Boot0 button while you click Reset. Then release DFU/Boot0 button

The GIF shows a Metro S2 but your board may look different. It will still have BOOT and Reset buttons somewhere

It should appear under Tools -> Port as ESP32-S2/S3 Dev Module.

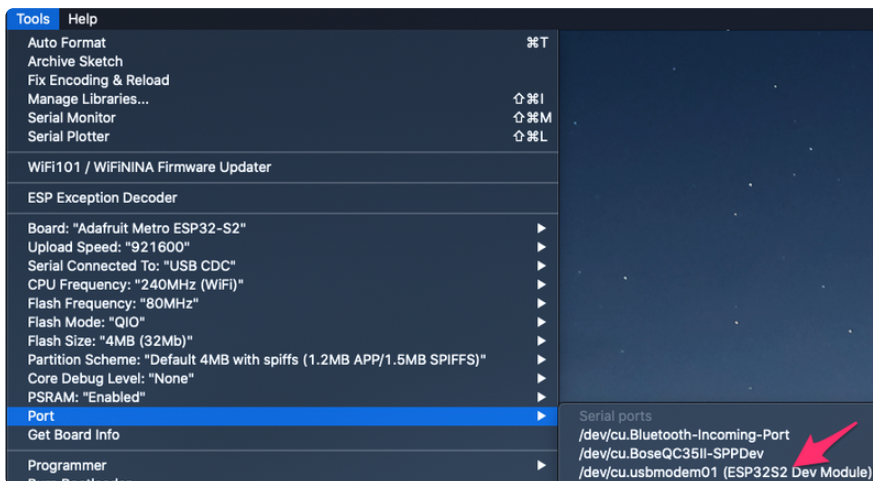

Do not select any other port than the one that is called "ESP32S2 Dev Module" or "ESP32S3 Dev Module"

Load Blink Sketch

Now open up this Blink example in a new sketch window

```
// the setup function runs once when you press reset or power the board
void setup() {
  // initialize built in LED pin as an output.
  pinMode(LED_BUILTIN, OUTPUT);
  // initialize USB serial converter so we have a port created
  Serial.begin();
}

// the loop function runs over and over again forever
```

```

void loop() {
  digitalWrite(LED_BUILTIN, HIGH); // turn the LED on (HIGH is the voltage level)
  delay(1000); // wait for a second
  digitalWrite(LED_BUILTIN, LOW); // turn the LED off by making the voltage LOW
  delay(1000); // wait for a second
}

```

Note that we use LED_BUILTIN not pin 13 for the LED pin. That's because we don't always use pin 13 for the LED on boards. For example, on the Metro ESP32-S2 the LED is on pin 42!

And click upload! After uploading, you may see something like this:

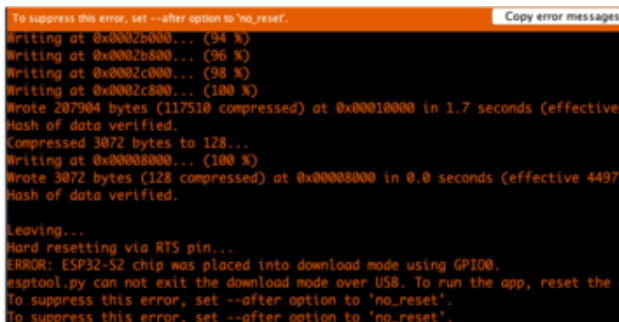

And click upload! After uploading, you may see something like this, warning you that we could not get out of reset.

This is normal! Press the RESET button on your board to launch the sketch

That's it, you will be able to see the red LED blink. You will also see a new serial port created.

You may call `Serial.begin();` in your sketch to create the serial port so don't forget it, it is not required for other Arduinos or previous ESP boards!

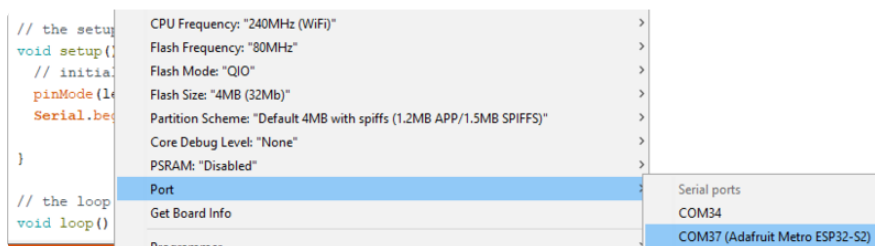

You can now select the new serial port name which will be different than the bootloader serial port. Arduino IDE will try to use auto-reset to automatically put the board into bootloader mode when you ask it to upload new code

If you ever DON'T see a serial port, or something is not working out with upload you can always manually enter bootloader mode:

- Reset board into ROM bootloader with DFU/BOOT0 + Reset buttons
- Select the ESP32S2/S3 Dev Board ROM bootloader serial port in Tools->Port menu
- Upload sketch
- Click reset button to launch code

Arduino Blink

The first and most basic program you can upload to your Arduino is the classic Blink sketch. This takes something on the board and makes it, well, blink! On and off. It's a great way to make sure everything is working and you're uploading your sketch to the right board and right configuration.

When all else fails, you can always come back to Blink!

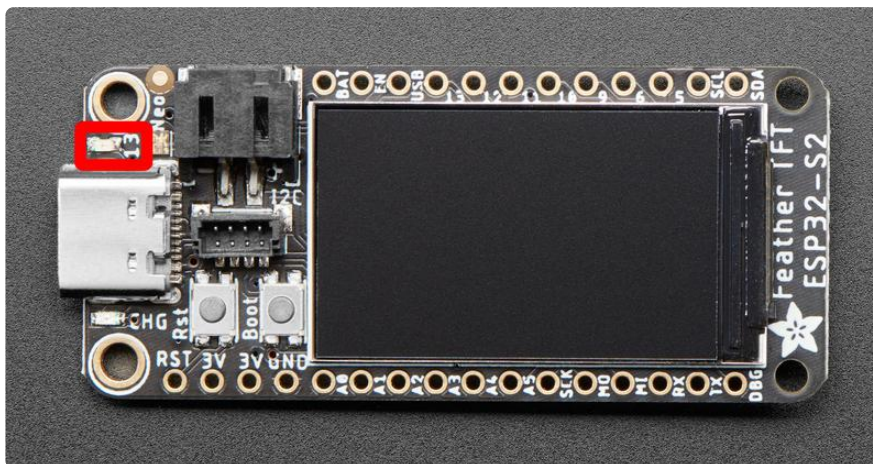

Pre-Flight Check: Get Arduino IDE & Hardware Set Up

This lesson assumes you have Arduino IDE set up. This is a generalized checklist, some elements may not apply to your hardware. If you haven't yet, check the previous steps in the guide to make sure you:

- Install the very latest Arduino IDE for Desktop (not all boards are supported by the Web IDE so we don't recommend it).

- Install any board support packages (BSP) required for your hardware. Some boards are built in defaults on the IDE, but lots are not! You may need to install plug-in support which is called the BSP.
- Get a Data/Sync USB cable for connecting your hardware. A significant amount of problems folks have stem from not having a USB cable with data pins. Yes, these cursed cables roam the land, making your life hard. If you find a USB cable that doesn't work for data/sync, throw it away immediately! There is no need to keep it around, cables are very inexpensive these days.
- Install any drivers required - If you have a board with a FTDI or CP210x chip, you may need to get separate drivers. If your board has native USB, it probably doesn't need anything. After installing, reboot to make sure the driver sinks in.
- Connect the board to your computer. If your board has a power LED, make sure its lit. Is there a power switch? Make sure its turned On!

Start up Arduino IDE and Select Board/Port

OK now you are prepared! Open the Arduino IDE on your computer. Now you have to tell the IDE what board you are using, and how you want to connect to it.

In the IDE find the Tools menu. You will use this to select the board. If you switch boards, you must switch the selection! So always double-check before you upload code in a new session.

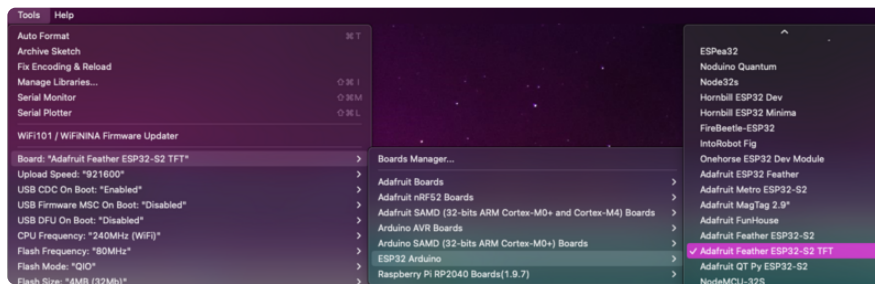

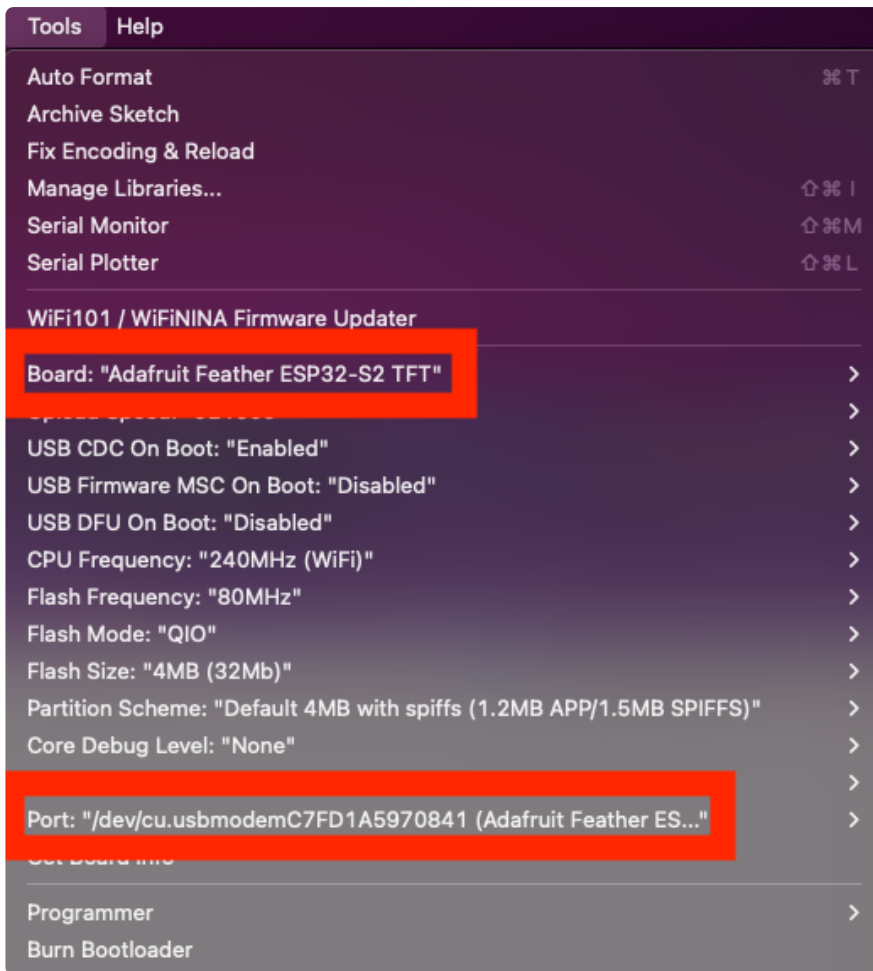

New Blink Sketch

OK lets make a new blink sketch! From the File menu, select New

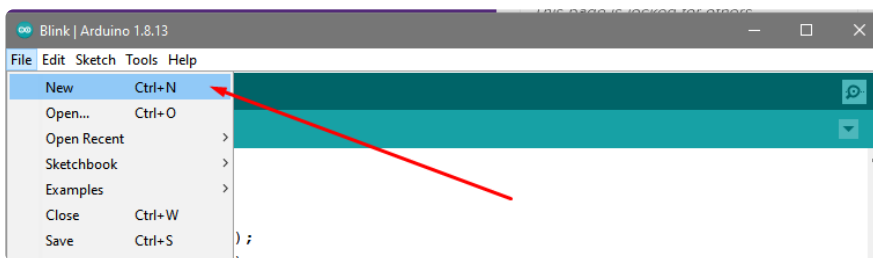

Then in the new window, copy and paste this text:

```
int led = LED_BUILTIN;

void setup() {
  // Some boards work best if we also make a serial connection
  Serial.begin(115200);

  // set LED to be an output pin
  pinMode(led, OUTPUT);
}
```

```
void loop() {  
  // Say hi!  
  Serial.println("Hello!");  
  
  digitalWrite(led, HIGH); // turn the LED on (HIGH is the voltage level)  
  delay(500); // wait for a half second  
  digitalWrite(led, LOW); // turn the LED off by making the voltage LOW  
  delay(500); // wait for a half second  
}
```

Note that in this example, we are not only blinking the LED but also printing to the Serial monitor, think of it as a little bonus to test the serial connection.

One note you'll see is that we reference the LED with the constant `LED_BUILTIN` rather than a number. That's because, historically, the built in LED was on pin 13 for Arduinos. But in the decades since, boards don't always have a pin 13, or maybe it could not be used for an LED. So the LED could have moved to another pin. It's best to use `LED_BUILTIN` so you don't get the pin number confused!

The red LED is located next to the USB connector, and is labeled 13 on the silk.

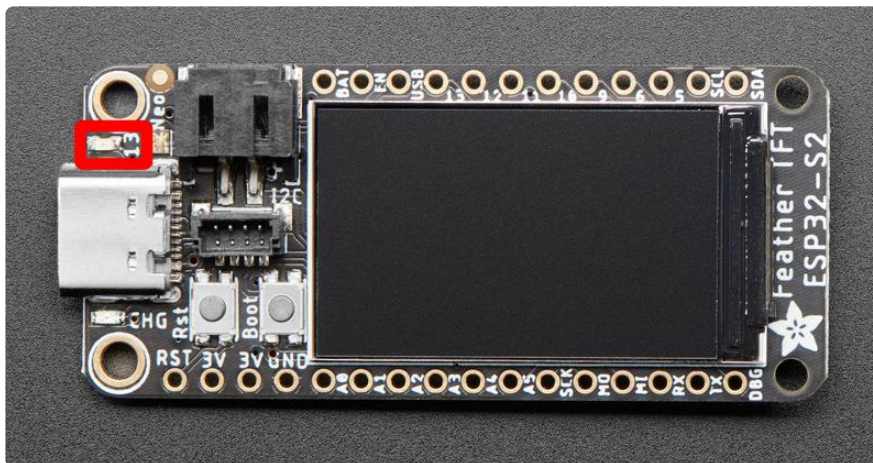

On the Feather TFT ESP32-S2, the red LED is on pin 13.

Verify (Compile) Sketch

OK now you can click the Verify button to convert the sketch into binary data to be uploaded to the board.

Note that Verifying a sketch is the same as Compiling a sketch - so we will use the words interchangeably

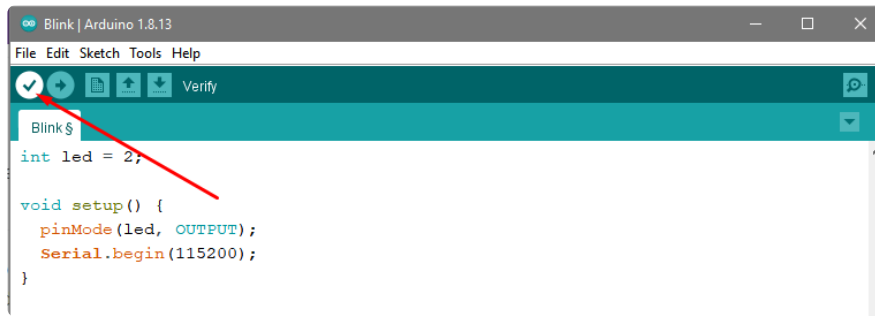

During verification/compilation, the computer will do a bunch of work to collect all the libraries and code and the results will appear in the bottom window of the IDE.

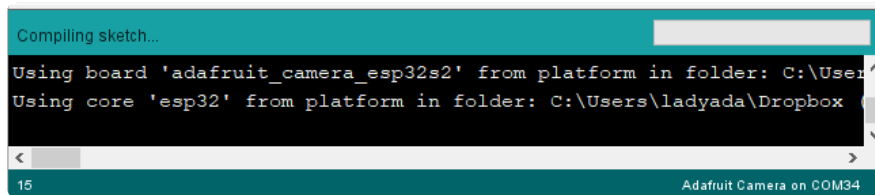

If something went wrong with compilation, you will get red warning/error text in the bottom window letting you know what the error was. It will also highlight the line with an error.

For example, here I had the wrong board selected - and the selected board does not have a built in LED!

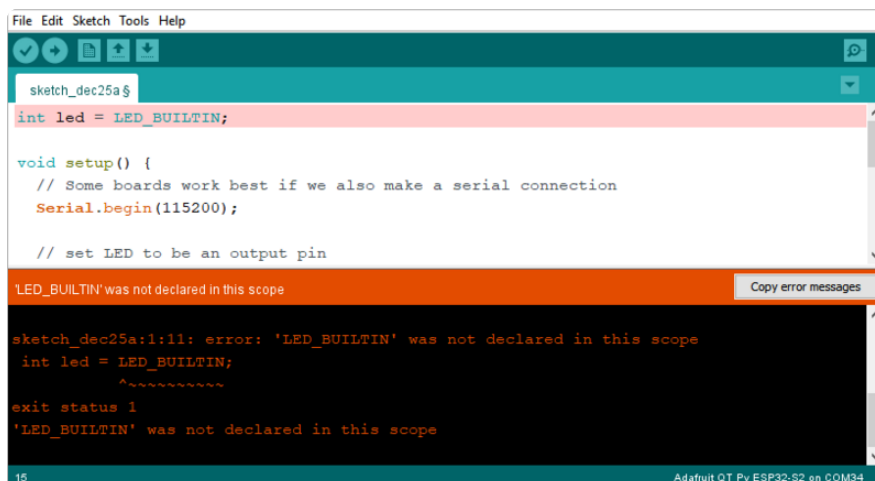

Here's another common error, in my haste I forgot to add a `;` at the end of a line. The compiler warns me that it's looking for one - note that the error is actually a few lines up!

```
sketch_dec25a$
int led = LED_BUILTIN;

void setup() {
  // Some boards work best if we also make a serial connection
  Serial.begin(115200);

  // set LED to be an output pin
}

error: expected \',\' or \';\' before \'void\'
void setup() {
  ^~~~~
exit status 1
error: expected \',\' or \';\' before \'void\'
```

Turning on detailed compilation warnings and output can be very helpful sometimes - Its in Preferences under "Show Verbose Output During:" and check the Compilation button. If you ever need to get help from others, be sure to do this and then provide all the text that is output. It can assist in nailing down what happened!

On success you will see something like this white text output and the message Done compiling. in the message area.

```
Done compiling.

Sketch uses 219874 bytes (16%) of program storage space. Maximum is 1310720 bytes.
Global variables use 17956 bytes (5%) of dynamic memory, leaving 309724 bytes for local
```

Upload Sketch

Once the code is verified/compiling cleanly you can upload it to your board. Click the Upload button.

```
sketch_dec25a$
int led = LED_BUILTIN;

void setup() {
  // Some boards work best if we also make a serial connection
  Serial.begin(115200);

  // set LED to be an output pin
}
```

The IDE will try to compile the sketch again for good measure, then it will try to connect to the board and upload a the file.

This is actually one of the hardest parts for beginners because it's where a lot of things can go wrong.

However, let's start with what it looks like on success! Here's what your board upload process looks like when it goes right:

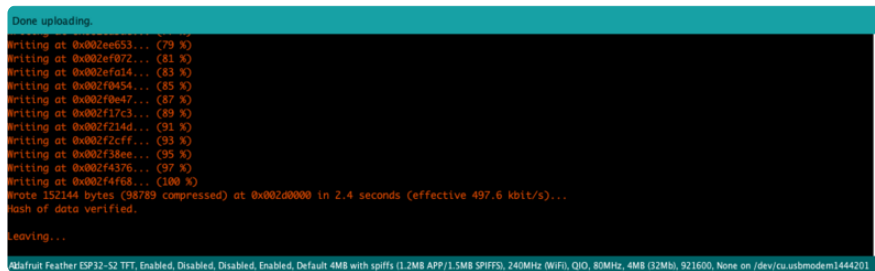

```
Done uploading.
Writing at 0x002ee653... (79 %)
Writing at 0x002ef072... (81 %)
Writing at 0x002efa14... (83 %)
Writing at 0x002f0454... (85 %)
Writing at 0x002f0e47... (87 %)
Writing at 0x002f17c3... (89 %)
Writing at 0x002f2140... (91 %)
Writing at 0x002f2cfe... (93 %)
Writing at 0x002f38ee... (95 %)
Writing at 0x002f4376... (97 %)
Writing at 0x002f4f68... (100 %)
Wrote 152144 bytes (98789 compressed) at 0x002d0000 in 2.4 seconds (effective 497.6 kbit/s)...
Hash of data verified.
Leaving...
```

Often times you will get a warning like this, which is kind of vague:

No device found on COM66 (or whatever port is selected)
An error occurred while uploading the sketch

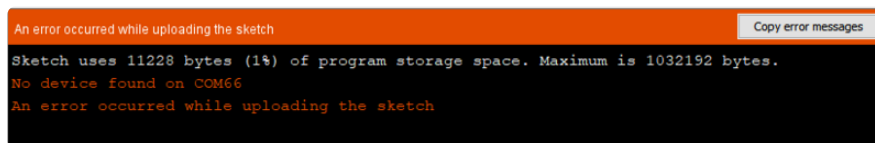

```
An error occurred while uploading the sketch
Sketch uses 11228 bytes (1%) of program storage space. Maximum is 1032192 bytes.
No device found on COM66
An error occurred while uploading the sketch
```

This could be a few things.

First up, check again that you have the correct board selected! Many electronics boards have very similar names or look, and often times folks grab a board different from what they thought.

If you're positive the right board is selected, we recommend the next step is to put the board into manual bootloading mode.

Native USB and manual bootloading

Historically, microcontroller boards contained two chips: the main micro chip (say, ATmega328 or ESP8266 or ESP32) and a separate chip for USB interface that would be used for bootloading (a CH430, FT232, CP210x, etc). With these older designs, the microcontroller is put into a bootloading state for uploading code by the separate chip. It allows for easier uploading but is more expensive as two chips are needed, and also the microcontroller can't act like a keyboard or disk drive.

Modern chips often have 'native' USB - that means that there is no separate chip for USB interface. It's all in one! Great for cost savings, simplicity of design, reduced size and more control. However, it means the chip must be self-aware enough to be able to put itself into bootload/upload mode on its own. That's fine 99% of the time but is very likely you will at some point get the board into an odd state that makes it too confused to bootload.

A lot of beginners have a little freakout the first time this happens, they think the board is ruined or 'bricked' - it's almost certainly not, it is just crashed and/or confused. You may need to perform a little trick to get the board back into a good state, at which point you won't need to manually bootload again.

Before continuing we really, really suggest turning on Verbose Upload messages, it will help in this process because you will be able to see what the IDE is trying to do. It's a checkbox in the Preferences menu.

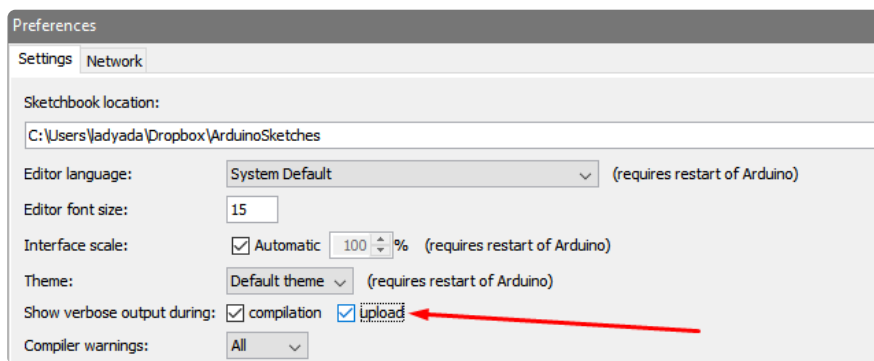

Enter Manual Bootload Mode

OK now you know it's probably time to try manual bootloading. No problem! Here is how you do that for this board:

Hold down the BOOT button, and while continuing to hold it, press the Reset button. Keep holding BOOT for a few seconds! The ROM bootloader does not show a drive, so nothing will happen when it is successful!

Once you are in manual bootload mode, go to the Tools menu, and make sure you have selected the bootloader serial port. It is almost certain that the serial port has changed now that the bootloader is enabled

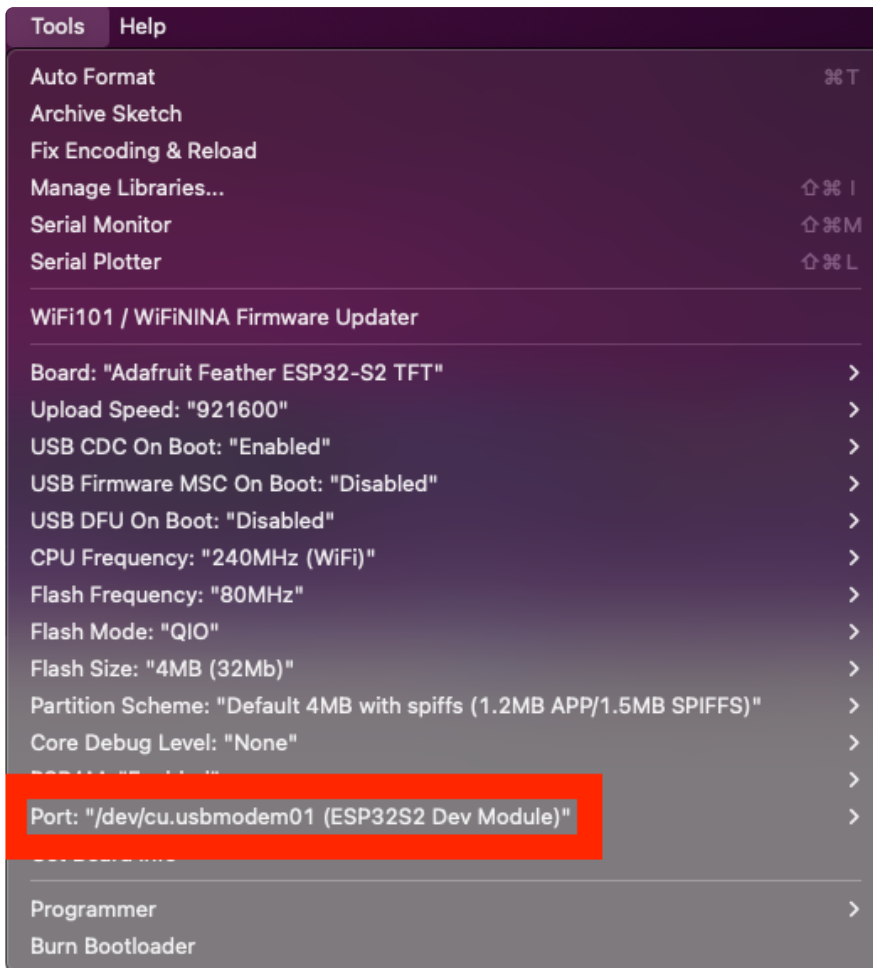

Now you can try uploading again!



Did you remember to select the new Port in the Tools menu since the bootloader port has changed?

This time, you should have success!

After uploading this way, be sure to click the reset button - it sort of makes sure that the board got a good reset and will come back to life nicely.

After uploading with Manual Bootloader - don't forget to re-select the old Port again

It's also a good idea to try to re-upload the sketch again now that you've performed a manual bootload to get the chip into a good state. It should perform an auto-reset the second time, so you don't have to manually bootload again.

Finally, a Blink!

OK it was a journey but now we're here and you can enjoy your blinking LED. Next up, try to change the delay between blinks and re-upload. It's a good way to make sure your upload process is smooth and practiced.

I2C Scan Test

A lot of sensors, displays, and devices can connect over I2C. I2C is a 2-wire 'bus' that allows multiple devices to all connect on one set of pins so it's very convenient for wiring!

When using your board, you'll probably want to connect up I2C devices, and it can be a little tricky the first time. The best way to debug I2C is go through a checklist and then perform an I2C scan

Common I2C Connectivity Issues

- Have you connected four wires (at a minimum) for each I2C device? Power the device with whatever is the logic level of your microcontroller board (probably 3.3V), then a ground wire, and a SCL clock wire, and and a SDA data wire.
- If you're using a STEMMA QT board - check if the power LED is lit. It's usually a green LED to the left side of the board.
- Does the STEMMA QT/I2C port have switchable power or pullups? To reduce power, some boards have the ability to cut power to I2C devices or the pullup resistors. Check the documentation if you have to do something special to turn on the power or pullups.
- If you are using a DIY I2C device, do you have pullup resistors? Many boards do not have pullup resistors built in and they are required! We suggest any common 2.2K to 10K resistors. You'll need two: one each connects from SDA to positive power, and SCL to positive power. Again, positive power (a.k.a VCC, VDD or V+) is often 3.3V
- Do you have an address collision? You can only have one board per address. So you cannot, say, connect two AHT20's to one I2C port because they have the

same address and will interfere. Check the sensor or documentation for the address. Sometimes there are ways to adjust the address.

- Does your board have multiple I2C ports? Historically, boards only came with one. But nowadays you can have two or even three! This can help solve the "hey, but what if I want two devices with the same address" problem: just put one on each bus.
- Are you hot-plugging devices? I2C does not support dynamic re-connection, you cannot connect and disconnect sensors as you please. They should all be connected on boot and not change. ([Only exception is if you're using a hot-plug assistant but that'll cost you \(\)](#)).
- Are you keeping the total bus length reasonable? I2C was designed for maybe 6" max length. We like to push that with plug-n-play cables, but really please keep them as short as possible! ([Only exception is if you're using an active bus extender \(\)](#)).

The TFT Feather has 10k pullups on I2C pins SCL and SDA. I2C shared by the broken out pins and the STEMMA QT connector.

There is a lipo battery monitor, LC709203F, on the I2C bus. There is a space for a BME280.

Perform an I2C scan!

Install TestBed Library

To scan I2C, the Adafruit TestBed library is used. This library and example just makes the scan a little easier to run because it takes care of some of the basics. You will need to add support by installing the library. Good news: it is very easy to do it. Go to the Arduino Library Manager.

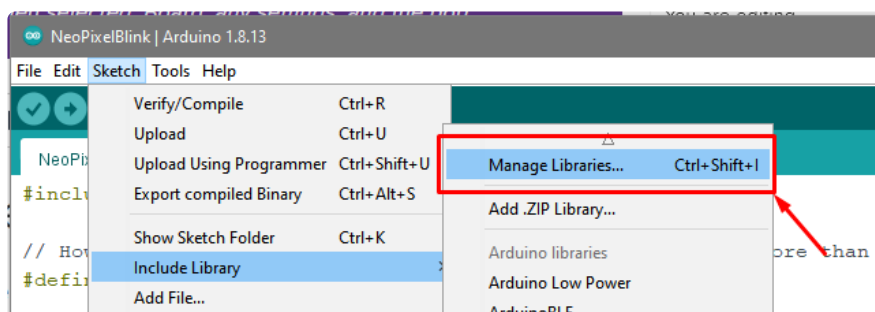

Search for TestBed and install the Adafruit TestBed library

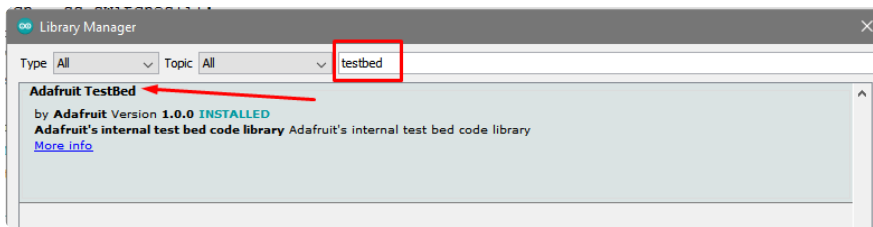

Now open up the I2C Scan example

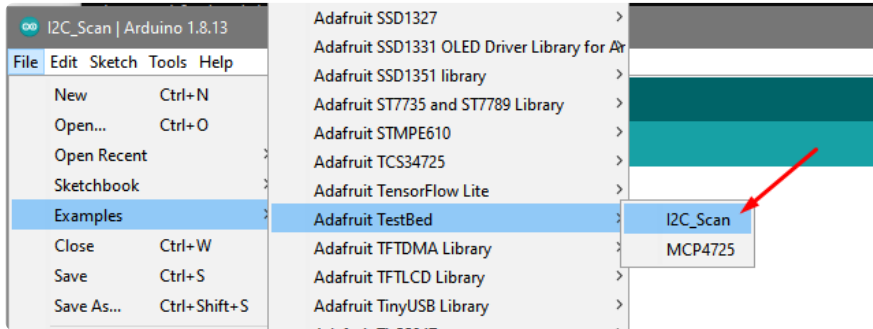

```
#include <Adafruit_TestBed.h>
extern Adafruit_TestBed TB;

#define DEFAULT_I2C_PORT &Wire

// Some boards have TWO I2C ports, how nifty. We should scan both
#if defined(ARDUINO_ARCH_RP2040) \
  || defined(ARDUINO_ADAFRUIT_QTPY_ESP32S2) \
  || defined(ARDUINO_ADAFRUIT_QTPY_ESP32S3_NOPSRAM) \
  || defined(ARDUINO_ADAFRUIT_QTPY_ESP32S3) \
  || defined(ARDUINO_ADAFRUIT_QTPY_ESP32_PICO) \
  || defined(ARDUINO_SAM_DUE)
  #define SECONDARY_I2C_PORT &Wire1
#endif

void setup() {
  Serial.begin(115200);

  // Wait for Serial port to open
  while (!Serial) {
    delay(10);
  }
  delay(500);
  Serial.println("Adafruit I2C Scanner");

  #if defined(ARDUINO_ADAFRUIT_QTPY_ESP32S2) || \
    defined(ARDUINO_ADAFRUIT_QTPY_ESP32S3_NOPSRAM) || \
    defined(ARDUINO_ADAFRUIT_QTPY_ESP32S3) || \
    defined(ARDUINO_ADAFRUIT_QTPY_ESP32_PICO)
    // ESP32 is kinda odd in that secondary ports must be manually
    // assigned their pins with setPins()!
    Wire1.setPins(SDA1, SCL1);
  #endif

  #if defined(ARDUINO_ADAFRUIT_FEATHER_ESP32S2)
    // turn on the I2C power by setting pin to opposite of 'rest state'
    pinMode(PIN_I2C_POWER, INPUT);
    delay(1);
    bool polarity = digitalRead(PIN_I2C_POWER);
    pinMode(PIN_I2C_POWER, OUTPUT);
    digitalWrite(PIN_I2C_POWER, !polarity);
  #endif
}
```

```

#if defined(ARDUINO_ADAFRUIT_FEATHER_ESP32S2_TFT)
  pinMode(TFT_I2C_POWER, OUTPUT);
  digitalWrite(TFT_I2C_POWER, HIGH);
#endif

#if defined(ARDUINO_ADAFRUIT_FEATHER_ESP32S2_REVTFT)
  pinMode(TFT_I2C_POWER, OUTPUT);
  digitalWrite(TFT_I2C_POWER, HIGH);
#endif

#if defined(ADAFRUIT_FEATHER_ESP32_V2)
  // Turn on the I2C power by pulling pin HIGH.
  pinMode(NEOPIXEL_I2C_POWER, OUTPUT);
  digitalWrite(NEOPIXEL_I2C_POWER, HIGH);
#endif
}

void loop() {
  Serial.println("");
  Serial.println("");

  Serial.print("Default port (Wire) ");
  TB.theWire = DEFAULT_I2C_PORT;
  TB.printI2CBusScan();

  #if defined(SECONDARY_I2C_PORT)
  Serial.print("Secondary port (Wire1) ");
  TB.theWire = SECONDARY_I2C_PORT;
  TB.printI2CBusScan();
  #endif

  delay(3000); // wait 3 seconds
}

```

Wire up I2C device

While the examples here will be using the [Adafruit MCP9808 \(\)](#), a high accuracy temperature sensor, the overall process is the same for just about any I2C sensor or device.

The first thing you'll want to do is get the sensor connected so your board has I2C to talk to.

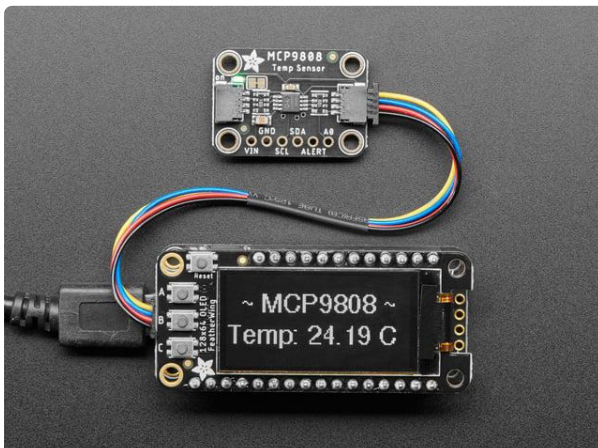

Adafruit MCP9808 High Accuracy I2C Temperature Sensor Breakout

The MCP9808 digital temperature sensor is one of the more accurate/precise we've ever seen, with a typical accuracy of $\pm 0.25^{\circ}\text{C}$ over the sensor's -40°C to...

<https://www.adafruit.com/product/5027>

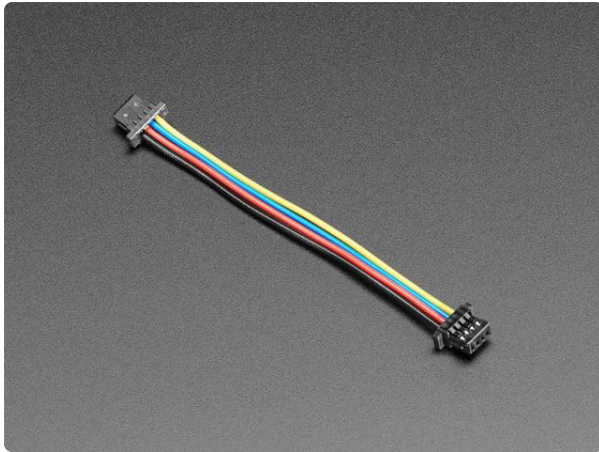

STEMMA QT / Qwiic JST SH 4-Pin Cable - 50mm Long

This 4-wire cable is 50mm / 1.9" long and fitted with JST SH female 4-pin connectors on both ends. Compared with the chunkier JST PH these are 1mm pitch instead of 2mm, but...

<https://www.adafruit.com/product/4399>

Wiring the MCP9808

The MCP9808 comes with a STEMMA QT connector, which makes wiring it up quite simple and solder-free.

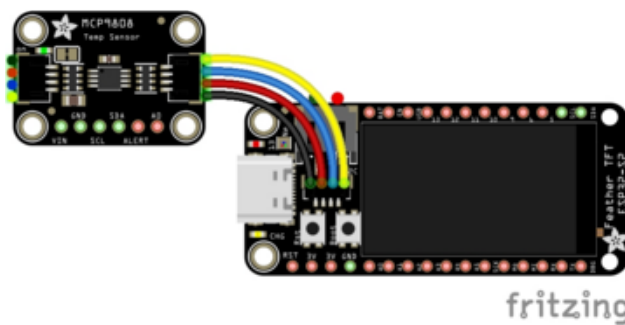

Using a [STEMMA QT cable](#) (), connect the STEMMA QT connector on the MCP9808 to the STEMMA QT connector on the Feather.

Now upload the scanning sketch to your microcontroller and open the serial port to see the output. You should see something like this:



I2C: On-Board LC709203 Battery Monitor

Your microcontroller board comes with an LC709203 lithium ion polymer (lipoly) battery monitor built right onto the board. The LC709203 is available over I2C.

The sensor comes with its own Adafruit CircuitPython library that makes it simple to write code to read data from it. This example will be using, among other things, the [Adafruit LC709203F \(\)](#) library.

The example simply reads data from the sensor and prints it to the serial console. It is designed to show you how to get data from the sensor.

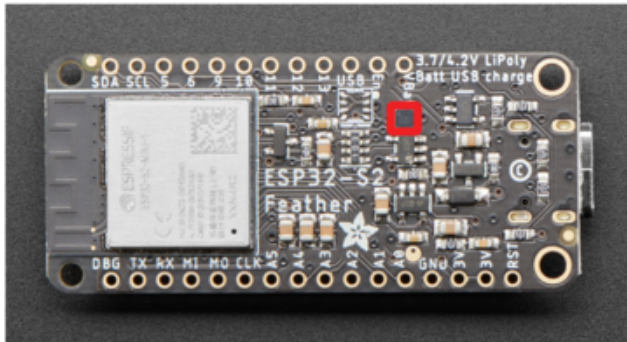

The LC709203 battery monitor (highlighted in red) is located on the bottom of the board near the VBAT pin label. Its I2C address is 0x0B. (0xb, which is returned by I2C scan, is the same as 0x0B, which simply has leading zeros.)

Arduino Library Installation

You can install the necessary libraries from the Library Manager. To open, click Sketch > Include Library > Manage Libraries...

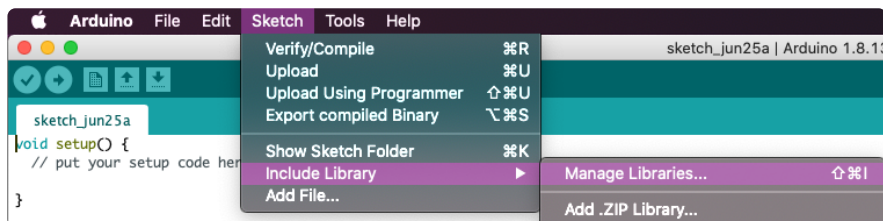

Search for LC709203F, and install the Adafruit LC709203F library.

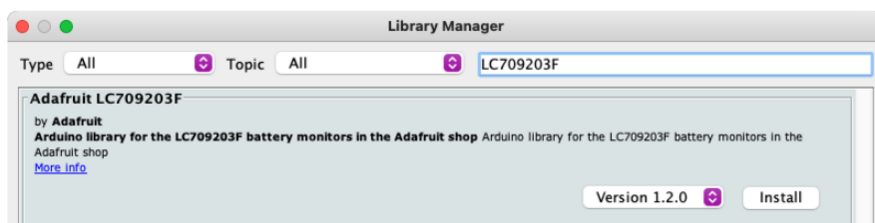

When asked about installing dependencies, click Install all.

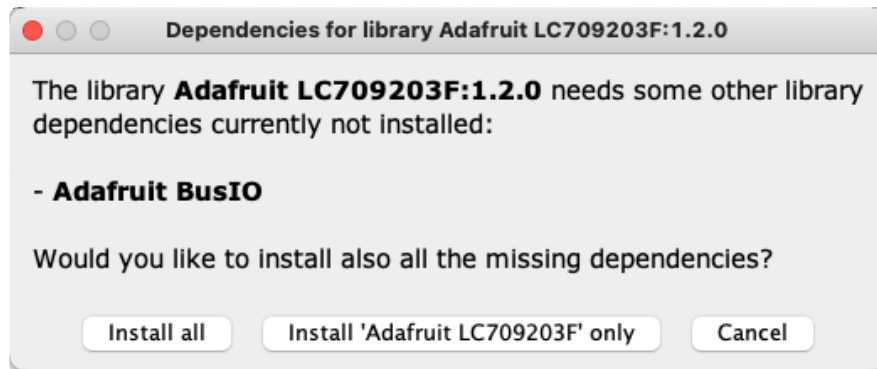

LC709203 Simple Data Example

Click File > Examples > Adafruit LC709203F > LC709203F_demo to open the example.

```
#include "Adafruit_LC709203F.h"

Adafruit_LC709203F lc;

void setup() {
  Serial.begin(115200);
  delay(10);
  Serial.println("\nAdafruit LC709203F demo");

  // For the Feather ESP32-S2, we need to enable I2C power first!
  // this section can be deleted for other boards
#ifdef ARDUINO_ADAFRUIT_FEATHER_ESP32S2
  // turn on the I2C power by setting pin to opposite of 'rest state'
  pinMode(PIN_I2C_POWER, INPUT);
  delay(1);
  bool polarity = digitalRead(PIN_I2C_POWER);
  pinMode(PIN_I2C_POWER, OUTPUT);
  digitalWrite(PIN_I2C_POWER, !polarity);
#endif

  if (!lc.begin()) {
    Serial.println(F("Couldnt find Adafruit LC709203F?\nMake sure a battery is
plugged in!"));
    while (1) delay(10);
  }
  Serial.println(F("Found LC709203F"));
  Serial.print("Version: 0x"); Serial.println(lc.getICversion(), HEX);

  lc.setThermistorB(3950);
  Serial.print("Thermistor B = "); Serial.println(lc.getThermistorB());

  lc.setPackSize(LC709203F_APA_500MAH);

  lc.setAlarmVoltage(3.8);
}

void loop() {
  Serial.print("Batt_Voltage:");
  Serial.print(lc.cellVoltage(), 3);
  Serial.print("\t");
  Serial.print("Batt_Percent:");
  Serial.print(lc.cellPercent(), 1);
  Serial.print("\t");
  Serial.print("Batt_Temp:");
```

```
Serial.println(lc.getCellTemperature(), 1);  
delay(2000); // dont query too often!  
}
```

After opening the LC709203F_demo file, upload it to your microcontroller. Open the Serial Monitor at 115200 baud. You should see the following as the sketch starts up.

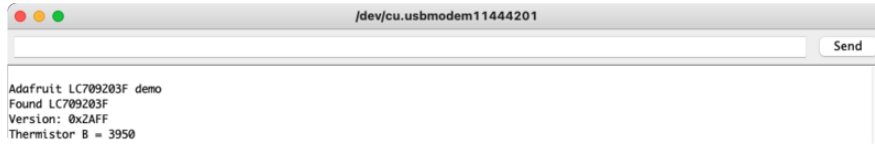

Once the sketch begins running, you should see something like the following.



That's all there is to reading battery data from the LC709203 using Arduino!

Built-In TFT

Your microcontroller board comes with a lovely TFT display built right in. The Arduino ST7735 and ST7789 Library enables you to use the TFT on your board with Arduino. This page shows you how to install the necessary libraries, and provides a graphics test example.

Arduino Library Installation

You'll need to install the ST7735 and ST7789 library to compile and run the following example. Open the Arduino IDE and then open the Library manager.

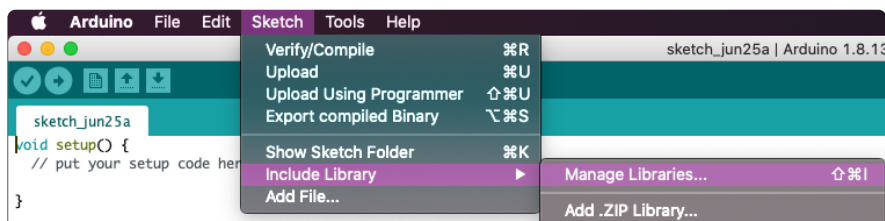

Click the Manage Libraries ... menu item, search for ST7789, and select the Adafruit ST7735 and ST7789 Library:



When asked to install any dependencies, click Install all.

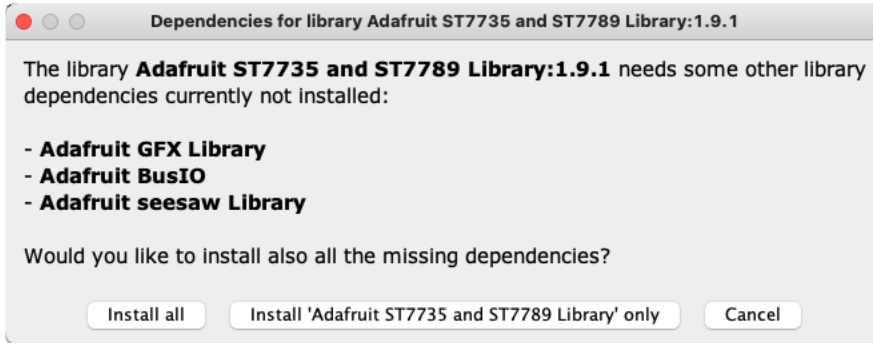

Graphics Test Example Code

The next thing you'll want to do is load the example code onto your board.

You can find the example through the Arduino IDE by clicking File > Adafruit ST7735 and ST7789 Library > graphicstest_feather_esp32s2_tft.

```
/******  
  This is a library for several Adafruit displays based on ST77* drivers.  
  
  Works with the Adafruit ESP32-S2 TFT Feather  
  ----> http://www.adafruit.com/products/5300  
  
  Check out the links above for our tutorials and wiring diagrams.  
  
  Adafruit invests time and resources providing this open source code,  
  please support Adafruit and open-source hardware by purchasing  
  products from Adafruit!  
  
  Written by Limor Fried/Ladyada for Adafruit Industries.  
  MIT license, all text above must be included in any redistribution  
  *****/  
  
#include <Adafruit_GFX.h>    // Core graphics library  
#include <Adafruit_ST7789.h> // Hardware-specific library for ST7789  
#include <SPI.h>  
  
// Use dedicated hardware SPI pins  
Adafruit_ST7789 tft = Adafruit_ST7789(TFT_CS, TFT_DC, TFT_RST);  
  
float p = 3.1415926;  
  
void setup(void) {  
  Serial.begin(9600);  
  Serial.print(F("Hello! Feather TFT Test"));  
  
  // turn on backlight
```



```

pinMode(TFT_BACKLITE, OUTPUT);
digitalWrite(TFT_BACKLITE, HIGH);

// turn on the TFT / I2C power supply
pinMode(TFT_I2C_POWER, OUTPUT);
digitalWrite(TFT_I2C_POWER, HIGH);
delay(10);

// initialize TFT
tft.init(135, 240); // Init ST7789 240x135
tft.setRotation(3);
tft.fillScreen(ST77XX_BLACK);

Serial.println(F("Initialized"));

uint16_t time = millis();
tft.fillScreen(ST77XX_BLACK);
time = millis() - time;

Serial.println(time, DEC);
delay(500);

// large block of text
tft.fillScreen(ST77XX_BLACK);
testdrawtext(
  "Lorem ipsum dolor sit amet, consectetur adipiscing elit. Curabitur "
  "adipiscing ante sed nibh tincidunt feugiat. Maecenas enim massa, "
  "fringilla sed malesuada et, malesuada sit amet turpis. Sed porttitor "
  "neque ut ante pretium vitae malesuada nunc bibendum. Nullam aliquet "
  "ultrices massa eu hendrerit. Ut sed nisi lorem. In vestibulum purus a "
  "tortor imperdiet posuere. ",
  ST77XX_WHITE);
delay(1000);

// tft print function!
tftPrintTest();
delay(4000);

// a single pixel
tft.drawPixel(tft.width() / 2, tft.height() / 2, ST77XX_GREEN);
delay(500);

// line draw test
testlines(ST77XX_YELLOW);
delay(500);

// optimized lines
testfastlines(ST77XX_RED, ST77XX_BLUE);
delay(500);

testdrawrects(ST77XX_GREEN);
delay(500);

testfillrects(ST77XX_YELLOW, ST77XX_MAGENTA);
delay(500);

tft.fillScreen(ST77XX_BLACK);
testfillcircles(10, ST77XX_BLUE);
testdrawcircles(10, ST77XX_WHITE);
delay(500);

testroundrects();
delay(500);

testtriangles();
delay(500);

mediabuttons();
delay(500);

```

```

Serial.println("done");
delay(1000);
}

void loop() {
  tft.invertDisplay(true);
  delay(500);
  tft.invertDisplay(false);
  delay(500);
}

void testlines(uint16_t color) {
  tft.fillScreen(ST77XX_BLACK);
  for (int16_t x = 0; x < tft.width(); x += 6) {
    tft.drawLine(0, 0, x, tft.height() - 1, color);
    delay(0);
  }
  for (int16_t y = 0; y < tft.height(); y += 6) {
    tft.drawLine(0, 0, tft.width() - 1, y, color);
    delay(0);
  }

  tft.fillScreen(ST77XX_BLACK);
  for (int16_t x = 0; x < tft.width(); x += 6) {
    tft.drawLine(tft.width() - 1, 0, x, tft.height() - 1, color);
    delay(0);
  }
  for (int16_t y = 0; y < tft.height(); y += 6) {
    tft.drawLine(tft.width() - 1, 0, 0, y, color);
    delay(0);
  }

  tft.fillScreen(ST77XX_BLACK);
  for (int16_t x = 0; x < tft.width(); x += 6) {
    tft.drawLine(0, tft.height() - 1, x, 0, color);
    delay(0);
  }
  for (int16_t y = 0; y < tft.height(); y += 6) {
    tft.drawLine(0, tft.height() - 1, tft.width() - 1, y, color);
    delay(0);
  }

  tft.fillScreen(ST77XX_BLACK);
  for (int16_t x = 0; x < tft.width(); x += 6) {
    tft.drawLine(tft.width() - 1, tft.height() - 1, x, 0, color);
    delay(0);
  }
  for (int16_t y = 0; y < tft.height(); y += 6) {
    tft.drawLine(tft.width() - 1, tft.height() - 1, 0, y, color);
    delay(0);
  }
}

void testdrawtext(char *text, uint16_t color) {
  tft.setCursor(0, 0);
  tft.setTextColor(color);
  tft.setTextWrap(true);
  tft.print(text);
}

void testfastlines(uint16_t color1, uint16_t color2) {
  tft.fillScreen(ST77XX_BLACK);
  for (int16_t y = 0; y < tft.height(); y += 5) {
    tft.drawFastHLine(0, y, tft.width(), color1);
  }
  for (int16_t x = 0; x < tft.width(); x += 5) {
    tft.drawFastVLine(x, 0, tft.height(), color2);
  }
}

```

```

}

void testdrawrects(uint16_t color) {
  tft.fillScreen(ST77XX_BLACK);
  for (int16_t x = 0; x < tft.width(); x += 6) {
    tft.drawRect(tft.width() / 2 - x / 2, tft.height() / 2 - x / 2, x, x,
                 color);
  }
}

void testfillrects(uint16_t color1, uint16_t color2) {
  tft.fillScreen(ST77XX_BLACK);
  for (int16_t x = tft.width() - 1; x > 6; x -= 6) {
    tft.fillRect(tft.width() / 2 - x / 2, tft.height() / 2 - x / 2, x, x,
                 color1);
    tft.drawRect(tft.width() / 2 - x / 2, tft.height() / 2 - x / 2, x, x,
                 color2);
  }
}

void testfillcircles(uint8_t radius, uint16_t color) {
  for (int16_t x = radius; x < tft.width(); x += radius * 2) {
    for (int16_t y = radius; y < tft.height(); y += radius * 2) {
      tft.fillCircle(x, y, radius, color);
    }
  }
}

void testdrawcircles(uint8_t radius, uint16_t color) {
  for (int16_t x = 0; x < tft.width() + radius; x += radius * 2) {
    for (int16_t y = 0; y < tft.height() + radius; y += radius * 2) {
      tft.drawCircle(x, y, radius, color);
    }
  }
}

void testtriangles() {
  tft.fillScreen(ST77XX_BLACK);
  uint16_t color = 0xF800;
  int t;
  int w = tft.width() / 2;
  int x = tft.height() - 1;
  int y = 0;
  int z = tft.width();
  for (t = 0; t <= 15; t++) {
    tft.drawTriangle(w, y, y, x, z, x, color);
    x -= 4;
    y += 4;
    z -= 4;
    color += 100;
  }
}

void testroundrects() {
  tft.fillScreen(ST77XX_BLACK);
  uint16_t color = 100;
  int i;
  int t;
  for (t = 0; t <= 4; t += 1) {
    int x = 0;
    int y = 0;
    int w = tft.width() - 2;
    int h = tft.height() - 2;
    for (i = 0; i <= 16; i += 1) {
      tft.drawRoundRect(x, y, w, h, 5, color);
      x += 2;
      y += 3;
      w -= 4;
      h -= 6;
    }
  }
}

```

```

        color += 1100;
    }
    color += 100;
}

void tftPrintTest() {
    tft.setTextWrap(false);
    tft.fillScreen(ST77XX_BLACK);
    tft.setCursor(0, 30);
    tft.setTextColor(ST77XX_RED);
    tft.setTextSize(1);
    tft.println("Hello World!");
    tft.setTextColor(ST77XX_YELLOW);
    tft.setTextSize(2);
    tft.println("Hello World!");
    tft.setTextColor(ST77XX_GREEN);
    tft.setTextSize(3);
    tft.println("Hello World!");
    tft.setTextColor(ST77XX_BLUE);
    tft.setTextSize(4);
    tft.print(1234.567);
    delay(1500);
    tft.setCursor(0, 0);
    tft.fillScreen(ST77XX_BLACK);
    tft.setTextColor(ST77XX_WHITE);
    tft.setTextSize(0);
    tft.println("Hello World!");
    tft.setTextSize(1);
    tft.setTextColor(ST77XX_GREEN);
    tft.print(p, 6);
    tft.println(" Want pi?");
    tft.println(" ");
    tft.print(8675309, HEX); // print 8,675,309 out in HEX!
    tft.println(" Print HEX!");
    tft.println(" ");
    tft.setTextColor(ST77XX_WHITE);
    tft.println("Sketch has been");
    tft.println("running for: ");
    tft.setTextColor(ST77XX_MAGENTA);
    tft.print(millis() / 1000);
    tft.setTextColor(ST77XX_WHITE);
    tft.print(" seconds.");
}

void mediabuttons() {
    // play
    tft.fillScreen(ST77XX_BLACK);
    tft.fillRoundRect(25, 5, 78, 60, 8, ST77XX_WHITE);
    tft.fillTriangle(42, 12, 42, 60, 90, 40, ST77XX_RED);
    delay(500);
    // pause
    tft.fillRoundRect(25, 70, 78, 60, 8, ST77XX_WHITE);
    tft.fillRoundRect(39, 78, 20, 45, 5, ST77XX_GREEN);
    tft.fillRoundRect(69, 78, 20, 45, 5, ST77XX_GREEN);
    delay(500);
    // play color
    tft.fillTriangle(42, 12, 42, 60, 90, 40, ST77XX_BLUE);
    delay(50);
    // pause color
    tft.fillRoundRect(39, 78, 20, 45, 5, ST77XX_RED);
    tft.fillRoundRect(69, 78, 20, 45, 5, ST77XX_RED);
    // play color
    tft.fillTriangle(42, 12, 42, 60, 90, 40, ST77XX_GREEN);
}

```

The initial setup in this example is specific to your board.

First, create an instance of the TFT, passing in the appropriate pins.

```
Adafruit_ST7789 tft = Adafruit_ST7789(TFT_CS, TFT_DC, TFT_RST);
```

Next, you'll turn on the backlight.

```
pinMode(TFT_BACKLITE, OUTPUT);  
digitalWrite(TFT_BACKLITE, HIGH);
```

Then, you'll turn on the power to the TFT.

```
pinMode(TFT_I2C_POWER, OUTPUT);  
digitalWrite(TFT_I2C_POWER, HIGH);  
delay(10);
```

Finally, you'll initialise the display with the width and height in pixels. Then, you'll set the rotation.

```
tft.init(135, 240);  
tft.setRotation(3);
```

Now, you're ready to display all sorts of text and graphics on your TFT. That's all there is to using the built in TFT on your board with Arduino!

For more details about this example, check out [this guide](#) ().

WiFi Test

Thankfully if you have ESP32 sketches, they'll 'just work' with variations of ESP32. You can find a wide range of examples in the File->Examples->Examples for Adafruit Metro ESP32-S2 subheading (the name of the board may vary so it could be "Examples for Adafruit Feather ESP32 V2" etc)

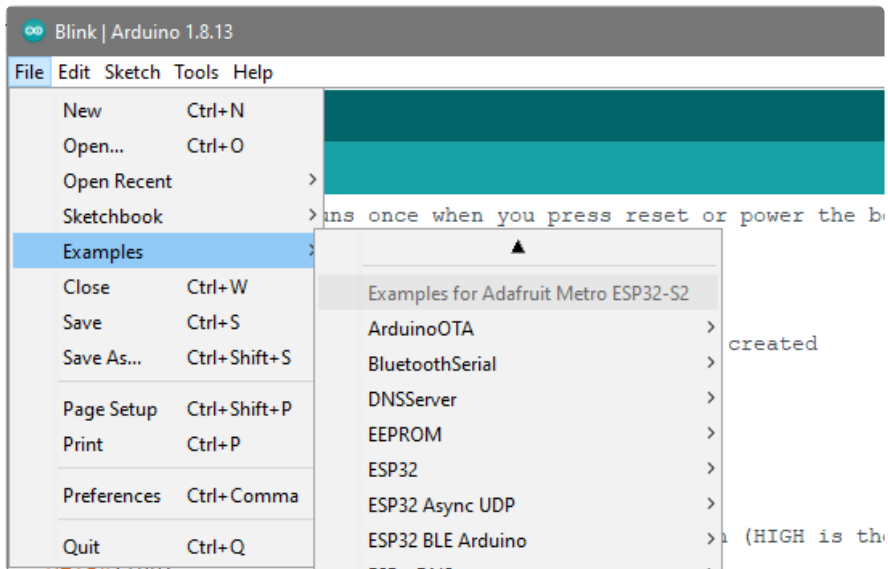

Let's start by scanning the local networks.

Load up the WiFiScan example under Examples->Examples for YOUR BOARDNAME->WiFi->WiFiScan

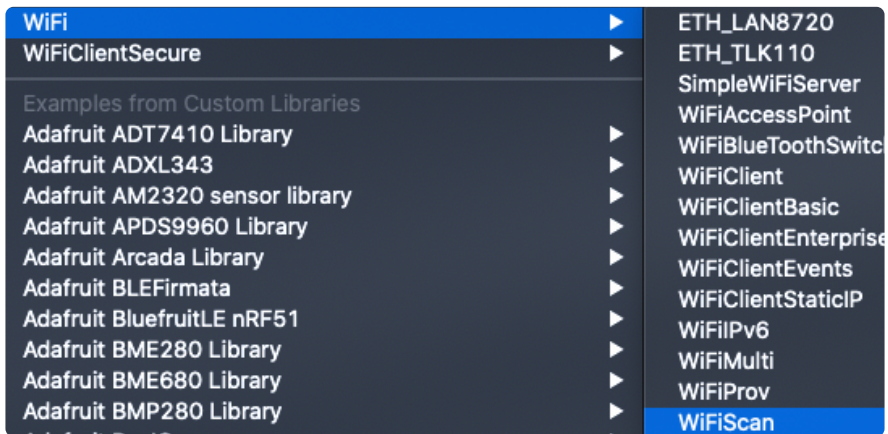

And upload this example to your board. The ESP32 should scan and find WiFi networks around you.

For ESP32, open the serial monitor, to see the scan begin.

For ESP32-S2, -S3 and -C3, don't forget you have to click Reset after uploading through the ROM bootloader. Then select the new USB Serial port created by the ESP32. It will take a few seconds for the board to complete the scan.

```
COM37
18:16:20.283 -> scan start
18:16:25.389 -> scan done
18:16:25.389 -> 12 networks found
18:16:25.389 -> 1: adafruit (-54)*
18:16:25.436 -> 2: MySpectrumWiFi73-2G (-56)*
18:16:25.436 -> 3: Sally (-57)*
18:16:25.436 -> 4: MySpectrumWiFi7C-2G (-58)*
18:16:25.436 -> 5: FiOS-K57GI (-68)*
18:16:25.436 -> 6: linksys_SES_2868 (-76)*
18:16:25.482 -> 7: patrick's Network (-76)*
18:16:25.482 -> 8: eufy RoboVac 30C-FA66 (-79)
18:16:25.482 -> 9: linksys_SES_2868 (-81)*
18:16:25.482 -> 10: VVCBR (-83)*
18:16:25.528 -> 11: FiOS-K57GI (-83)*
18:16:25.528 -> 12: Patrick (-83)*
18:16:25.528 ->
18:16:30.520 -> scan start
```

If you can not scan any networks, check your power supply. You need a solid power supply in order for the ESP32 to not brown out. A skinny USB cable or drained battery can cause issues.

WiFi Connection Test

Now that you can scan networks around you, its time to connect to the Internet!

Copy the example below and paste it into the Arduino IDE:

```
// SPDX-FileCopyrightText: 2020 Brent Rubell for Adafruit Industries
//
// SPDX-License-Identifier: MIT

/*
  Web client

  This sketch connects to a website (wifitest.adafruit.com/testwifi/index.html)
  using the WiFi module.

  This example is written for a network using WPA encryption. For
  WEP or WPA, change the Wifi.begin() call accordingly.

  This example is written for a network using WPA encryption. For
  WEP or WPA, change the Wifi.begin() call accordingly.

  created 13 July 2010
  by dlf (Metodo2 srl)
  modified 31 May 2012
  by Tom Igoe
  */

#include <WiFi.h>
```

```

// Enter your WiFi SSID and password
char ssid[] = "YOUR_SSID";           // your network SSID (name)
char pass[] = "YOUR_SSID_PASSWORD";  // your network password (use for WPA, or
use as key for WEP)
int keyIndex = 0;                    // your network key Index number (needed
only for WEP)

int status = WL_IDLE_STATUS;
// if you don't want to use DNS (and reduce your sketch size)
// use the numeric IP instead of the name for the server:
//IPAddress server(74,125,232,128); // numeric IP for Google (no DNS)

char server[] = "wifitest.adafruit.com"; // name address for adafruit test
char path[] = "/testwifi/index.html";

// Initialize the Ethernet client library
// with the IP address and port of the server
// that you want to connect to (port 80 is default for HTTP):
WiFiClient client;

void setup() {
  //Initialize serial and wait for port to open:
  Serial.begin(115200);
  while (!Serial) {
    ; // wait for serial port to connect. Needed for native USB port only
  }

  // attempt to connect to Wifi network:
  Serial.print("Attempting to connect to SSID: ");
  Serial.println(ssid);

  WiFi.begin(ssid, pass);
  while (WiFi.status() != WL_CONNECTED) {
    delay(500);
    Serial.print(".");
  }

  Serial.println("");
  Serial.println("Connected to WiFi");
  printWifiStatus();

  Serial.println("\nStarting connection to server...");
  // if you get a connection, report back via serial:
  if (client.connect(server, 80)) {
    Serial.println("connected to server");
    // Make a HTTP request:
    client.print("GET "); client.print(path); client.println(" HTTP/1.1");
    client.print("Host: "); client.println(server);
    client.println("Connection: close");
    client.println();
  }
}

void loop() {
  // if there are incoming bytes available
  // from the server, read them and print them:
  while (client.available()) {
    char c = client.read();
    Serial.write(c);
  }

  // if the server's disconnected, stop the client:
  if (!client.connected()) {
    Serial.println();
    Serial.println("disconnecting from server.");
    client.stop();

    // do nothing forevermore:
    while (true) {

```



```

        delay(100);
    }
}

void printWifiStatus() {
  // print the SSID of the network you're attached to:
  Serial.print("SSID: ");
  Serial.println(WiFi.SSID());

  // print your board's IP address:
  IPAddress ip = WiFi.localIP();
  Serial.print("IP Address: ");
  Serial.println(ip);

  // print the received signal strength:
  long rssi = WiFi.RSSI();
  Serial.print("signal strength (RSSI):");
  Serial.print(rssi);
  Serial.println(" dBm");
}

```

NOTE: You must change the **SECRET_SSID** and **SECRET_PASS** in the example code to your WiFi SSID and password before uploading this to your board.

```

// Enter your WiFi SSID and password
char ssid[] = "YOUR_SSID";           // your network SSID (name)
char pass[] = "YOUR_SSID_PASSWORD"; // your network password (use for WPA, or use as key for WEP)
int keyIndex = 0;                    // your network key Index number (needed only for WEP)

```

After you've set it correctly, upload and check the serial monitor. You should see the following. If not, go back, check wiring, power and your SSID/password

```
Attempting to connect to SSID: Transit
.....
Connected to WiFi
SSID: Transit
IP Address: 192.168.1.182
signal strength (RSSI):-57 dBm

Starting connection to server...
connected to server
HTTP/1.1 200 OK
Server: nginx/1.10.3 (Ubuntu)
Date: Wed, 11 Nov 2020 20:51:30 GMT
Content-Type: text/html
Content-Length: 70
Last-Modified: Thu, 16 May 2019 18:21:16 GMT
Connection: close
ETag: "5cddaa1c-46"
Accept-Ranges: bytes

This is a test of Adafruit WiFi!
If you can read this, its working :)

disconnecting from server.
```

Secure Connection Example

Many servers today do not allow non-SSL connectivity. Lucky for you the ESP32 has a great TLS/SSL stack so you can have that all taken care of for you. Here's an example of a using a secure WiFi connection to connect to the Twitter API.

Copy and paste it into the Arduino IDE:

```
// SPDX-FileCopyrightText: 2015 Arturo Guadalupi
// SPDX-FileCopyrightText: 2020 Brent Rubell for Adafruit Industries
//
// SPDX-License-Identifier: MIT

/*
This example creates a client object that connects and transfers
data using always SSL.

It is compatible with the methods normally related to plain
connections, like client.connect(host, port).

Written by Arturo Guadalupi
last revision November 2015

*/

#include <WiFiClientSecure.h>
```

```

// Enter your WiFi SSID and password
char ssid[] = "YOUR_SSID";           // your network SSID (name)
char pass[] = "YOUR_SSID_PASSWORD";  // your network password (use for WPA, or
use as key for WEP)
int keyIndex = 0;                     // your network key Index number (needed
only for WEP)

int status = WL_IDLE_STATUS;
// if you don't want to use DNS (and reduce your sketch size)
// use the numeric IP instead of the name for the server:
//IPAddress server(74,125,232,128); // numeric IP for Google (no DNS)

#define SERVER "cdn.syndication.twimg.com"
#define PATH   "/widgets/followbutton/info.json?screen_names=adafruit"

// Initialize the SSL client library
// with the IP address and port of the server
// that you want to connect to (port 443 is default for HTTPS):
WiFiClientSecure client;

void setup() {
  //Initialize serial and wait for port to open:
  Serial.begin(115200);
  while (!Serial) {
    ; // wait for serial port to connect. Needed for native USB port only
  }

  // attempt to connect to Wifi network:
  Serial.print("Attempting to connect to SSID: ");
  Serial.println(ssid);

  WiFi.begin(ssid, pass);
  while (WiFi.status() != WL_CONNECTED) {
    delay(500);
    Serial.print(".");
  }

  Serial.println("");
  Serial.println("Connected to WiFi");
  printWifiStatus();

  client.setInsecure(); // don't use a root cert

  Serial.println("\nStarting connection to server...");
  // if you get a connection, report back via serial:
  if (client.connect(SERVER, 443)) {
    Serial.println("connected to server");
    // Make a HTTP request:
    client.println("GET " PATH " HTTP/1.1");
    client.println("Host: " SERVER);
    client.println("Connection: close");
    client.println();
  }
}

uint32_t bytes = 0;

void loop() {
  // if there are incoming bytes available
  // from the server, read them and print them:
  while (client.available()) {
    char c = client.read();
    Serial.write(c);
    bytes++;
  }

  // if the server's disconnected, stop the client:
  if (!client.connected()) {
    Serial.println();

```

```

Serial.println("disconnecting from server.");
client.stop();
Serial.print("Read "); Serial.print(bytes); Serial.println(" bytes");

// do nothing forevermore:
while (true);
}
}

void printWifiStatus() {
// print the SSID of the network you're attached to:
Serial.print("SSID: ");
Serial.println(WiFi.SSID());

// print your board's IP address:
IPAddress ip = WiFi.localIP();
Serial.print("IP Address: ");
Serial.println(ip);

// print the received signal strength:
long rssi = WiFi.RSSI();
Serial.print("signal strength (RSSI):");
Serial.print(rssi);
Serial.println(" dBm");
}

```

As before, update the ssid and password first, then upload the example to your board.

Note we use `WiFiClientSecure client` instead of `WiFiClient client`; to require a SSL connection! This example will connect to a twitter server to download a JSON snippet that says how many followers adafruit has

```

Attempting to connect to SSID: Transit
.....
Connected to WiFi
SSID: Transit
IP Address: 192.168.1.182
signal strength (RSSI):-52 dBm

Starting connection to server...
connected to server
HTTP/1.1 200 OK
Accept-Ranges: bytes
Access-Control-Allow-Origin: platform.twitter.com
Access-Control-Allow-Methods: GET
Age: 12
cache-control: must-revalidate, max-age=600
content-disposition: attachment; filename=json.json
Content-Type: application/json;charset=utf-8
Date: Wed, 11 Nov 2020 20:58:39 GMT
expires: Wed, 11 Nov 2020 21:08:39 GMT
Last-Modified: Wed, 11 Nov 2020 20:58:27 GMT
Server: ECS (agb/52BA)
strict-transport-security: max-age=631138519
timing-allow-origin: *
X-Cache: HIT
x-connection-hash: a50988a9020759ec70520caef6c38bcf
x-content-type-options: nosniff
x-frame-options: SAMEORIGIN
x-response-time: 12
x-transaction: 003d88570028acec
x-tw-cdn: VZ
x-tw-cdn: VZ
x-xss-protection: 0
Content-Length: 197
Connection: close

[{"following":false,"id":"20731304","screen_name":"adafruit","name":"adafruit industries"},
disconnecting from server.
Read 966 bytes

```

JSON Parsing Demo

This example is a little more advanced - many sites will have API's that give you JSON data. We will build on the previous SSL example to connect to twitter and get that JSON data chunk

Then we'll use [ArduinoJSON \(\)](#) to convert that to a format we can use and then display that data on the serial port (which can then be re-directed to a display of some sort)

First up, [use the Library manager to install ArduinoJSON \(\)](#).

Then load the example JSONdemo by copying the code below and pasting it into your Arduino IDE.

```
// SPDX-FileCopyrightText: 2014 Benoit Blanchon
// SPDX-FileCopyrightText: 2014 Arturo Guadalupi
// SPDX-FileCopyrightText: 2020 Brent Rubell for Adafruit Industries
//
// SPDX-License-Identifier: MIT

/*
This example creates a client object that connects and transfers
data using always SSL, then shows how to parse a JSON document in an HTTP response.

It is compatible with the methods normally related to plain
connections, like client.connect(host, port).

Written by Arturo Guadalupi + Copyright Benoit Blanchon 2014-2019
last revision November 2015

*/

#include <WiFiClientSecure.h>
#include <ArduinoJson.h>
#include <Wire.h>

// uncomment the next line if you have a 128x32 OLED on the I2C pins
// #define USE_OLED
// uncomment the next line to deep sleep between requests
// #define USE_DEEPSLEEP

#if defined(USE_OLED)
// Some boards have TWO I2C ports, how nifty. We should use the second one sometimes
#if defined(ARDUINO_ADAFRUIT_QTPY_ESP32S2) || \
    defined(ARDUINO_ADAFRUIT_QTPY_ESP32S3_NOPSRAM) || \
    defined(ARDUINO_ADAFRUIT_QTPY_ESP32_PICO)
    #define OLED_I2C_PORT &Wire1
#else
    #define OLED_I2C_PORT &Wire
#endif
#endif

#include <Adafruit_SSD1306.h>
Adafruit_SSD1306 display = Adafruit_SSD1306(128, 32, OLED_I2C_PORT);
#endif

// Enter your WiFi SSID and password
char ssid[] = "YOUR_SSID"; // your network SSID (name)
```

```

char pass[] = "YOUR_SSID_PASSWORD"; // your network password (use for WPA, or
use as key for WEP)
int keyIndex = 0; // your network key Index number (needed
only for WEP)

int status = WL_IDLE_STATUS;
// if you don't want to use DNS (and reduce your sketch size)
// use the numeric IP instead of the name for the server:
//IPAddress server(74,125,232,128); // numeric IP for Google (no DNS)

#define SERVER "cdn.syndication.twimg.com"
#define PATH "/widgets/followbutton/info.json?screen_names=adafruit"

void setup() {
  //Initialize serial and wait for port to open:
  Serial.begin(115200);

  // Connect to WPA/WPA2 network
  WiFi.begin(ssid, pass);

  #if defined(USE_OLED)
    setupI2C();
    delay(200); // wait for OLED to reset

    if(!display.begin(SSD1306_SWITCHCAPVCC, 0x3C)) { // Address 0x3C for 128x32
      Serial.println(F("SSD1306 allocation failed"));
      for(;;); // Don't proceed, loop forever
    }
    display.display();
    display.setTextSize(1);
    display.setTextColor(WHITE);
    display.clearDisplay();
    display.setCursor(0,0);
  #else
    // Don't wait for serial if we have an OLED
    while (!Serial) {
      // wait for serial port to connect. Needed for native USB port only
      delay(10);
    }
  #endif
  // attempt to connect to Wifi network:
  Serial.print("Attempting to connect to SSID: ");
  Serial.println(ssid);
  #if defined(USE_OLED)
    display.clearDisplay(); display.setCursor(0,0);
    display.print("Connecting to SSID\n"); display.println(ssid);
    display.display();
  #endif

  while (WiFi.status() != WL_CONNECTED) {
    delay(500);
    Serial.print(".");
  }

  Serial.println("");
  Serial.println("Connected to WiFi");

  #if defined(USE_OLED)
    display.print("...OK!");
    display.display();
  #endif

  printWifiStatus();
}

uint32_t bytes = 0;

```

```

void loop() {
  WiFiClientSecure client;
  client.setInsecure(); // don't use a root cert

  Serial.println("\nStarting connection to server...");
  #if defined(USE_OLED)
    display.clearDisplay(); display.setCursor(0,0);
    display.print("Connecting to "); display.print(SERVER);
    display.display();
  #endif

  // if you get a connection, report back via serial:
  if (client.connect(SERVER, 443)) {
    Serial.println("connected to server");
    // Make a HTTP request:
    client.println("GET " PATH " HTTP/1.1");
    client.println("Host: " SERVER);
    client.println("Connection: close");
    client.println();
  }

  // Check HTTP status
  char status[32] = {0};
  client.readBytesUntil('\r', status, sizeof(status));
  if (strcmp(status, "HTTP/1.1 200 OK") != 0) {
    Serial.print(F("Unexpected response: "));
    Serial.println(status);
  #if defined(USE_OLED)
    display.print("Connection failed, code: "); display.println(status);
    display.display();
  #endif

  return;
}

// wait until we get a double blank line
client.find("\r\n\r\n", 4);

// Allocate the JSON document
// Use arduinojson.org/v6/assistant to compute the capacity.
const size_t capacity = JSON_ARRAY_SIZE(1) + JSON_OBJECT_SIZE(8) + 200;
DynamicJsonDocument doc(capacity);

// Parse JSON object
DeserializationError error = deserializeJson(doc, client);
if (error) {
  Serial.print(F("deserializeJson() failed: "));
  Serial.println(error.c_str());
  return;
}

// Extract values
JsonObject root_0 = doc[0];
Serial.println(F("Response:"));
const char* root_0_screen_name = root_0["screen_name"];
long root_0_followers_count = root_0["followers_count"];

Serial.print("Twitter username: "); Serial.println(root_0_screen_name);
Serial.print("Twitter followers: "); Serial.println(root_0_followers_count);
#if defined(USE_OLED)
  display.clearDisplay(); display.setCursor(0,0);
  display.setTextSize(2);
  display.println(root_0_screen_name);
  display.println(root_0_followers_count);
  display.display();
  display.setTextSize(1);
#endif
}

```

```

// Disconnect
client.stop();
delay(1000);

#if defined(USE_DEEPSLEEP)
#if defined(USE_OLED)
  display.clearDisplay();
  display.display();
#endif // OLED
#if defined(NEOPIXEL_POWER)
  digitalWrite(NEOPIXEL_POWER, LOW); // off
#elif defined(NEOPIXEL_I2C_POWER)
  digitalWrite(NEOPIXEL_I2C_POWER, LOW); // off
#endif
  // wake up 1 second later and then go into deep sleep
  esp_sleep_enable_timer_wakeup(10 * 1000UL * 1000UL); // 10 sec
  esp_deep_sleep_start();
#else
  delay(10 * 1000);
#endif
}

void setupI2C() {
  #if defined(ARDUINO_ADAFRUIT_QTPY_ESP32S2) || \
    defined(ARDUINO_ADAFRUIT_QTPY_ESP32S3_NOPSRAM) || \
    defined(ARDUINO_ADAFRUIT_QTPY_ESP32_PICO)
    // ESP32 is kinda odd in that secondary ports must be manually
    // assigned their pins with setPins()!
    Wire1.setPins(SDA1, SCL1);
  #endif

  #if defined(NEOPIXEL_I2C_POWER)
  pinMode(NEOPIXEL_I2C_POWER, OUTPUT);
  digitalWrite(NEOPIXEL_I2C_POWER, HIGH); // on
  #endif

  #if defined(ARDUINO_ADAFRUIT_FEATHER_ESP32S2)
  // turn on the I2C power by setting pin to opposite of 'rest state'
  pinMode(PIN_I2C_POWER, INPUT);
  delay(1);
  bool polarity = digitalRead(PIN_I2C_POWER);
  pinMode(PIN_I2C_POWER, OUTPUT);
  digitalWrite(PIN_I2C_POWER, !polarity);
  #endif
}

void printWifiStatus() {
  // print the SSID of the network you're attached to:
  Serial.print("SSID: ");
  Serial.println(WiFi.SSID());

  // print your board's IP address:
  IPAddress ip = WiFi.localIP();
  Serial.print("IP Address: ");
  Serial.println(ip);

  // print the received signal strength:
  long rssi = WiFi.RSSI();
  Serial.print("signal strength (RSSI):");
  Serial.print(rssi);
  Serial.println(" dBm");
}

```

By default it will connect to to the Twitter banner image API, parse the username and followers, and display them.

```
Attempting to connect to SSID: Transit
.....
Connected to WiFi
SSID: Transit
IP Address: 192.168.1.182
signal strength (RSSI):-54 dBm

Starting connection to server...
connected to server
Response:
Twitter username: adafruit
Twitter followers: 176400
```

Usage with Adafruit IO

The ESP32-S2/S3 is an affordable, all-in-one, option for connecting your projects to the internet [using our IoT platform, Adafruit IO \(\)](#).

- For more information and guides about Adafruit IO, check out the [Adafruit IO Basics Series. \(\)](#)

Install Libraries

In the Arduino IDE, navigate to Sketch -> Include Library->Manage Libraries...

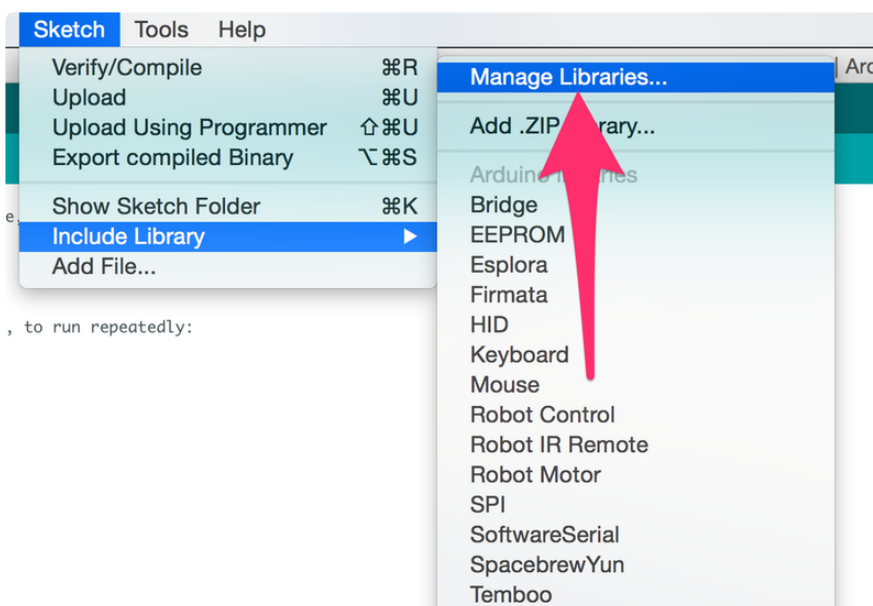

Enter Adafruit IO Arduino into the search box, and click Install on the Adafruit IO Arduino library option to install version 4.0.0 or higher.

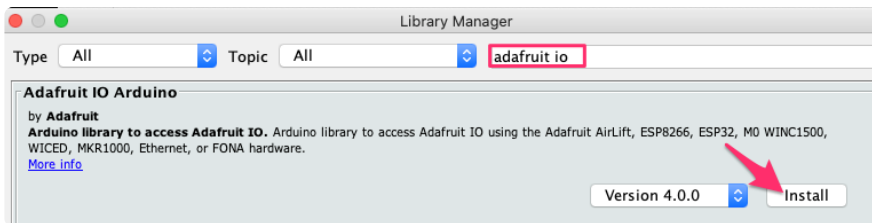

When asked to install dependencies, click Install all.

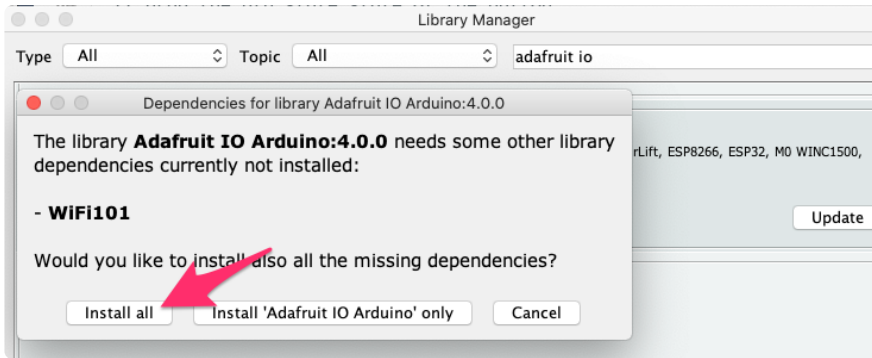

Adafruit IO Setup

If you do not already have an Adafruit IO account, [create one now](#) (). Next, navigate to the Adafruit IO Dashboards page.

We'll create a dashboard to visualize and interact with the data being sent between your ESP32-S2/S3 board and Adafruit IO.



brubell > Dashboards



Create a new Dashboard ×

Name

Description

Show Header Image

Header Image
 No file chosen
[Sample header image with breakpoints marked.](#)

Click the New Dashboard button.
Name your dashboard My ESP32-S2 or My ESP32-S3 depending on your board.
Your new dashboard should appear in the list.
Click the link to be brought to your new dashboard.

<input type="checkbox"/> LoRa Feather Network	lora-feather-network
<input type="checkbox"/> My Air Quality Sensor	my-air-quality-sensor
<input type="checkbox"/> My ESP32-S2	my-esp32-s2
<input type="checkbox"/> My Garage	my-garage

We'll want to turn the board's LED on or off from Adafruit IO. To do this, we'll need to add a toggle button to our dashboard.

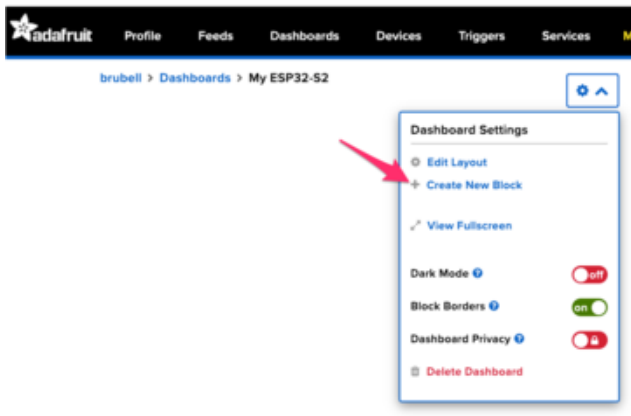

Create a new block

Click on the block you would like to add to your dashboard. You can switch the block type later if you change your mind.

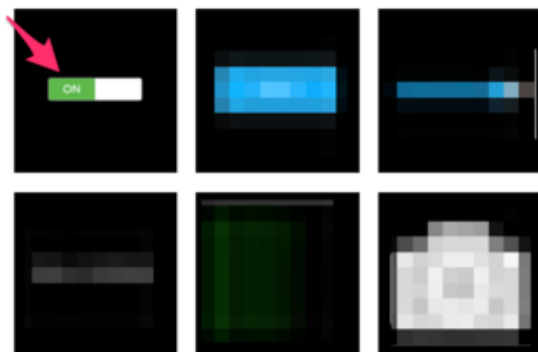

<input type="checkbox"/>	led	HIGH	9 minutes
<input type="checkbox"/>	lwill	rip	over 1 year
<input type="checkbox"/>	moisture	2	1 day
<input type="checkbox"/>	neopixel		2 days
<input type="checkbox"/>	outdoor-lights	#000000	about 2 ye
<input type="checkbox"/>	relay	morning	about 3 ho
<input type="checkbox"/>	temperature	72	1 day
<input type="checkbox"/>	test	66	2 days
<input type="checkbox"/>	timecube	4.5	almost 2 ye
<input type="checkbox"/>	zapemail	Gary Thompson...	1 day
<input type="text" value="led"/>	<input type="button" value="Create"/>		

My Feeds

Feed Name	Last value	Recorded
<input type="checkbox"/> battery	55	1 day
<input type="checkbox"/> digital	1	about 17 hours
<input type="checkbox"/> humidity	10	2 days
<input type="checkbox"/> image	/9j/4QAWRXhp...	5 months
<input type="checkbox"/> indoor-lights	#000000	about 2 years
<input checked="" type="checkbox"/> led		less than a min...
<input type="checkbox"/> lwill	rip	over 1 year
<input type="checkbox"/> moisture	2	1 day
<input type="checkbox"/> neopixel		2 days
<input type="checkbox"/> outdoor-lights	#000000	about 2 years

Click the cog at the top right hand corner of your dashboard.
 In the dashboard settings dropdown, click Create New Block.
 Select the toggle block.
 Under My Feeds, enter led as a feed name. Click Create.
 Choose the led feed to connect it to the toggle block. Click Next step.

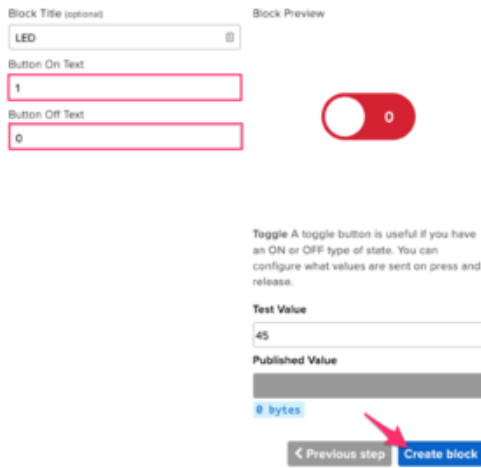

Under Block Settings,

Change Button On Text to 1
Change Button Off Text to 0
Click Create block

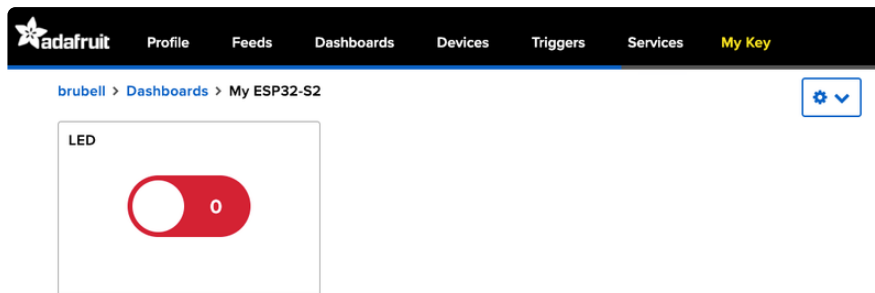

Next up, we'll want to display button press data from your board on Adafruit IO. To do this, we'll add a gauge block to the Adafruit IO dashboard. A gauge is a read only block type that shows a fixed range of values.

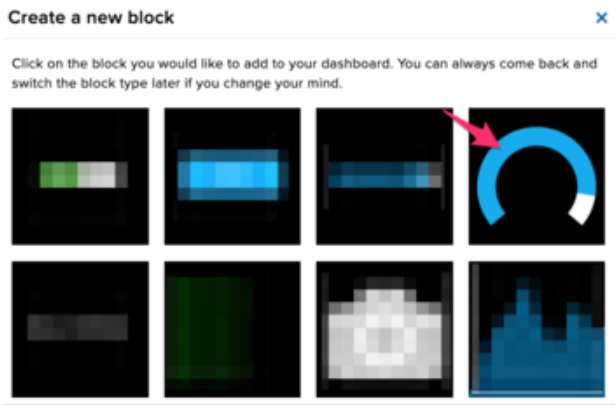

Block Name	Feed Name	Last Update	Lock Icon
<input type="checkbox"/> image	/9j/4QAWRXhp...	5 months	🔒
<input type="checkbox"/> indoor-lights	#000000	about 2 years	🔒
<input type="checkbox"/> led		16 minutes	🔒
<input type="checkbox"/> lwill	rip	over 1 year	🔒
<input type="checkbox"/> moisture	2	1 day	🔒
<input type="checkbox"/> neopixel		2 days	🔒
<input type="checkbox"/> outdoor-lights	#000000	about 2 years	🔒
<input type="checkbox"/> relay	morning	about 3 hours	🔒
<input type="checkbox"/> temperature	72	1 day	🔒
<input type="checkbox"/> test	66	2 days	🔒
<input type="checkbox"/> timecube	4.5	almost 2 years	🔒
<input type="checkbox"/> zapemail	Gary Thompson...	1 day	🔒
<input type="text" value="button"/>			

Click the cog at the top right hand corner of your dashboard.
 In the dashboard settings dropdown, click Create New Block.
 Select the gauge block.
 Under My Feeds, enter button as a feed name.
 Click Create.
 Choose the button feed to connect it to the toggle block.
 Click Next step.

Create a Gauge Block

A gauge is a read only block type that shows a fixed range of values. Choose a single feed you would like to connect to this gauge feed within a group.

My Feeds

Feed Name	Last value
<input type="checkbox"/> battery	55
<input checked="" type="checkbox"/> button	

Block settings



In this final step, you can give your block a title and see a preview of how it will look. Customize the look and feel of your block with the remaining settings. When you are ready, click the "Create Block" button to send it to your dashboard.

Block Title (optional)

Gauge Min Value

Gauge Max Value

Gauge Width

Gauge Label

Low Warning Value

Block Preview



Gauge A gauge is a read only block type that shows a fixed range of values.

Under block settings,

Change Block Title to Button Value

Change Gauge Min Value to 0, the button's state when it's off

Change Gauge Max Value to 1, the button's state when it's on

Click Create block

Your dashboard should look like the following:

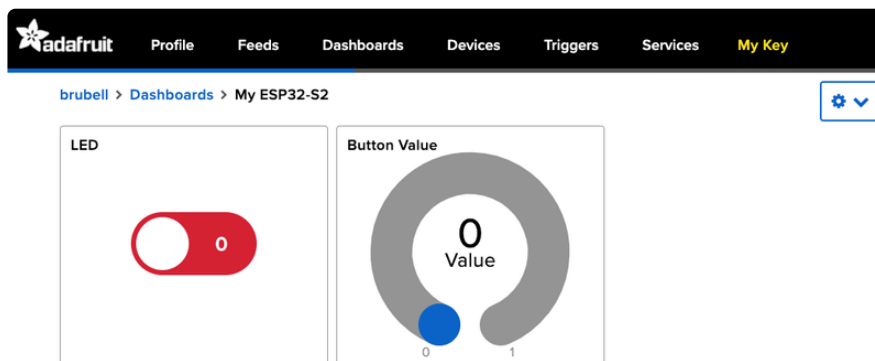

Code Usage

For this example, you will need to open the `adafruitio_26_led_btn` example included with the Adafruit IO Arduino library. In the Arduino IDE, navigate to File -> Examples -> Adafruit IO Arduino -> `adafruitio_26_led_btn`.

Before uploading this code to the ESP32-S2/S3, you'll need to add your network and Adafruit IO credentials. Click on the `config.h` tab in the sketch.

Obtain your Adafruit IO Credentials from [navigating to io.adafruit.com](https://io.adafruit.com) and clicking [My Key \(\)](#). Copy and paste these credentials next to `IO_USERNAME` and `IO_KEY`.

```

adafruitio_26_led_btn - config.h | Arduino 1.8.13
adafruitio_26_led_btn config.h
1 /***** Adafruit IO Config *****/
2
3 // visit io.adafruit.com if you need to create an account,
4 // or if you need your Adafruit IO key.
5 #define IO_USERNAME "your_username"
6 #define IO_KEY "your_key"
7

```

Enter your network credentials next to `WIFI_SSID` and `WIFI_PASS`.

```

adafruitio_26_led_btn config.h
20
21 #define WIFI_SSID "your_ssid"
22 #define WIFI_PASS "your_pass"
23
24 // uncomment the following line if you are using airlift
25 //#define USE_AIRLIFT
26
27 // uncomment the following line if you are using winc1500
28 // #define USE_WINC1500
29

```

Click the Upload button to upload your sketch to the ESP32-S2/S3. After uploading, press the RESET button on your board to launch the sketch.

Open the Arduino Serial monitor and navigate to the Adafruit IO dashboard you created. You should see the gauge response to button press and the board's LED light up in response to the Toggle Switch block.

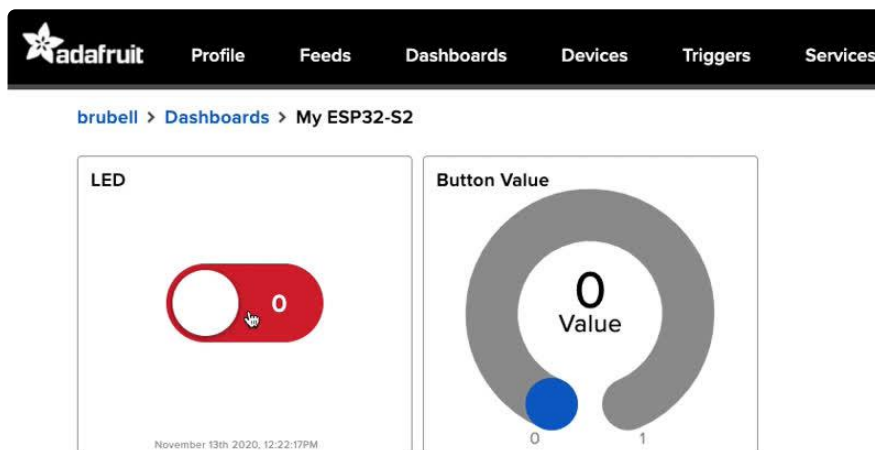

You should also see the ESP32-S2/S3's LED turning on and off when the LED is toggled:

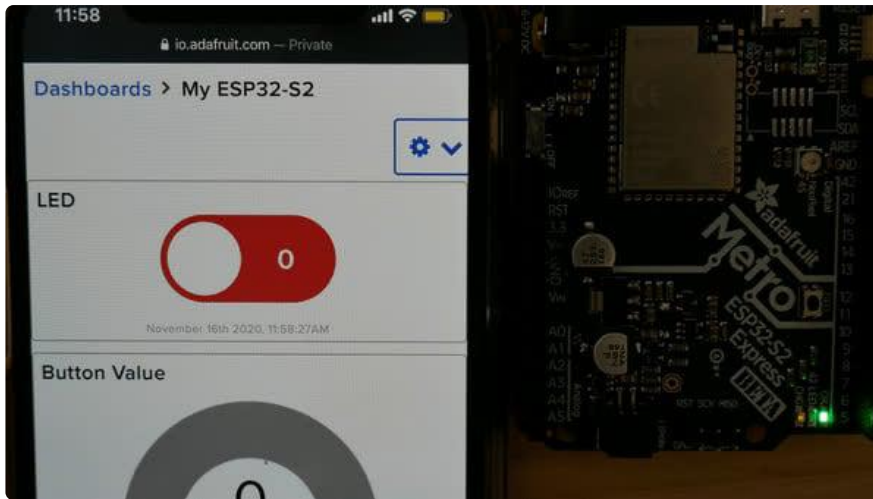

Factory Shipped Demo

Your Adafruit ESP32-S2 TFT Feather ships from the factory with a I2C and graphics test demo. You can download a UF2 of the demo from the [Factory Reset page](#) (). The UF2 does not give you access to the source code to allow you to see what is going on in the code and potentially edit it. This page provides the factory demo source code, including walking you through what libraries to install to get it going.

Arduino Library Installation

You can install the necessary libraries from the Library Manager. To open, click Sketch > Include Library > Manage Libraries...

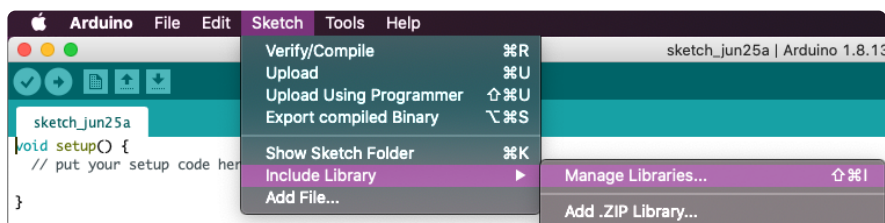

Next, you'll search for the following libraries, and install them and any necessary dependencies.

Search for LC709203F and install the Adafruit LC709203F Library.

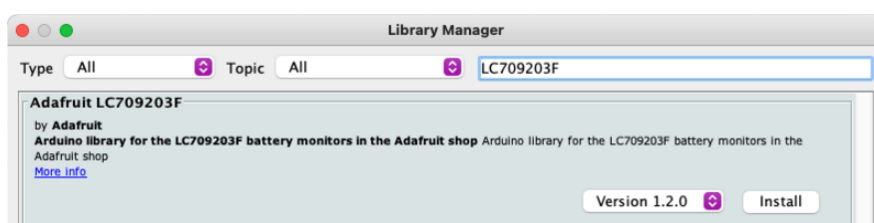

When asked to install dependencies, click Install all.

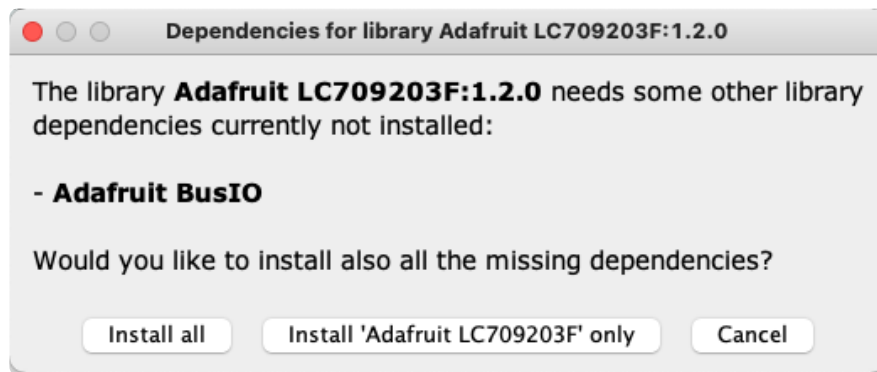

Search for NeoPixel and install the Adafruit NeoPixel library.

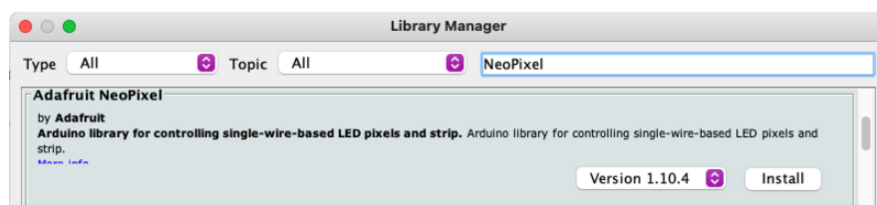

Search for TestBed and install the Adafruit TestBed library.

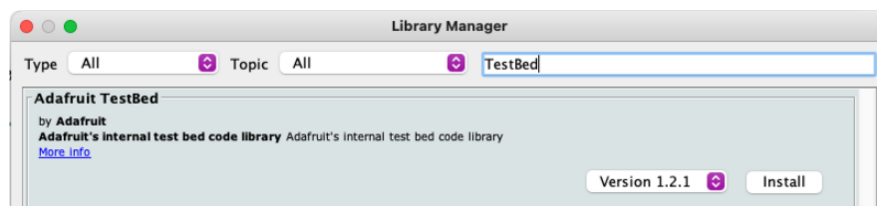

When asked to install dependencies, click Install all.



Search for BME280 and install the Adafruit BME280 Library.

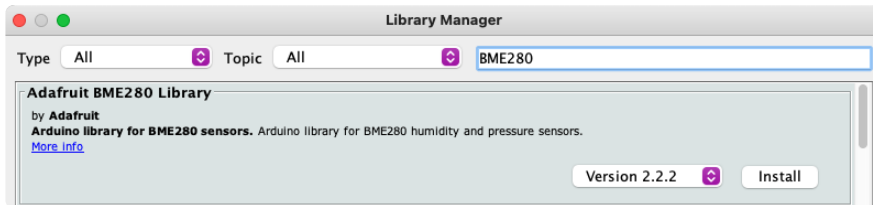

When asked to install dependencies, click Install all.

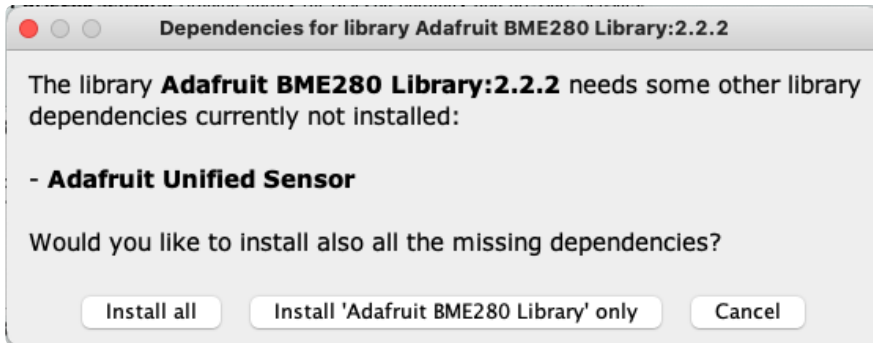

Search for ST7789 and install the Adafruit ST7735 and ST7789 Library.

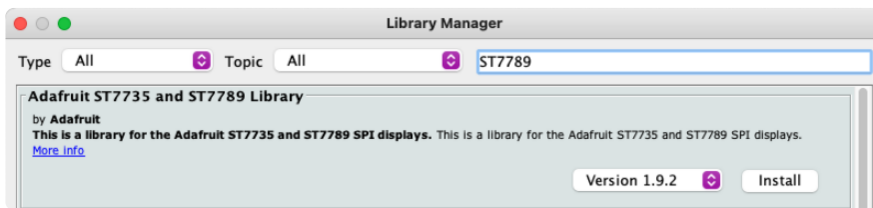

When asked to install dependencies, click Install all.

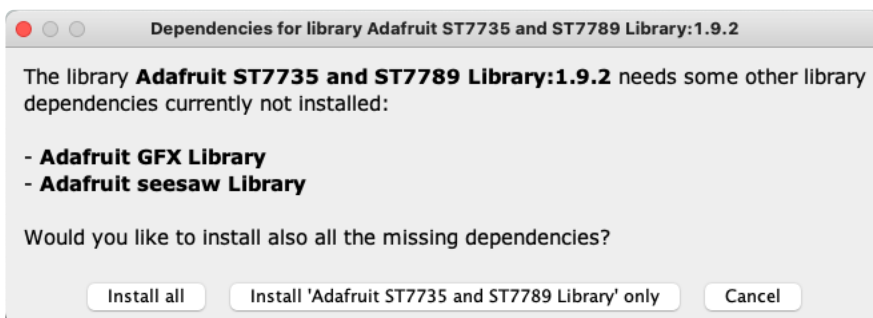

Factory Demo Example Code

Now, you'll want to upload the following sketch onto your ESP32-S2 TFT Feather.

```
// SPDX-FileCopyrightText: 2022 Limor Fried for Adafruit Industries
//
// SPDX-License-Identifier: MIT

#include <Arduino.h>
#include "Adafruit_LC709203F.h"
#include <Adafruit_NeoPixel.h>
```

```

#include "Adafruit_TestBed.h"
#include <Adafruit_BME280.h>
#include <Adafruit_ST7789.h>
#include <Fonts/FreeSans12pt7b.h>

Adafruit_BME280 bme; // I2C
bool bmeFound = false;
extern Adafruit_TestBed TB;

Adafruit_LC709203F lc;
Adafruit_ST7789 display = Adafruit_ST7789(TFT_CS, TFT_DC, TFT_RST);

GFXcanvas16 canvas(240, 135);

void setup() {
  Serial.begin(115200);
  // while (! Serial) delay(10);

  delay(100);

  // turn on the TFT / I2C power supply
  pinMode(TFT_I2C_POWER, OUTPUT);
  digitalWrite(TFT_I2C_POWER, HIGH);

  pinMode(NEOPIXEL_POWER, OUTPUT);
  digitalWrite(NEOPIXEL_POWER, HIGH);
  delay(10);

  TB.neopixelPin = PIN_NEOPIXEL;
  TB.neopixelNum = 1;
  TB.begin();
  TB.setColor(WHITE);

  display.init(135, 240);          // Init ST7789 240x135
  display.setRotation(3);
  canvas.setFont(&FreeSans12pt7b);
  canvas.setTextColor(ST77XX_WHITE);

  if (!lc.begin()) {
    Serial.println(F("Couldnt find Adafruit LC709203F?\nMake sure a battery is
plugged in!"));
    while (1);
  }

  Serial.println("Found LC709203F");
  Serial.print("Version: 0x"); Serial.println(lc.getICversion(), HEX);
  lc.setPacking(LC709203F_APA_500MAH);

  if (TB.scanI2Cbus(0x77)) {
    Serial.println("BME280 address");

    unsigned status = bme.begin();
    if (!status) {
      Serial.println("Could not find a valid BME280 sensor, check wiring, address,
sensor ID!");
      Serial.print("SensorID was: 0x"); Serial.println(bme.sensorID(),16);
      Serial.print("          ID of 0xFF probably means a bad address, a BMP 180 or
BMP 085\n");
      Serial.print("          ID of 0x56-0x58 represents a BMP 280,\n");
      Serial.print("          ID of 0x60 represents a BME 280.\n");
      Serial.print("          ID of 0x61 represents a BME 680.\n");
      return;
    }
    Serial.println("BME280 found OK");
    bmeFound = true;
  }
}

uint8_t j = 0;

```

```

void loop() {
  Serial.println("*****");

  TB.printI2CScan();

  if (j % 5 == 0) {
    canvas.fillScreen(ST77XX_BLACK);
    canvas.setCursor(0, 25);
    canvas.setTextColor(ST77XX_RED);
    canvas.println("Adafruit Feather");
    canvas.setTextColor(ST77XX_YELLOW);
    canvas.println("ESP32-S2 TFT Demo");
    canvas.setTextColor(ST77XX_GREEN);
    canvas.print("Battery: ");
    canvas.setTextColor(ST77XX_WHITE);
    canvas.print(lc.cellVoltage(), 1);
    canvas.print(" V / ");
    canvas.print(lc.cellPercent(), 0);
    canvas.println("%");
    canvas.setTextColor(ST77XX_BLUE);
    canvas.print("I2C: ");
    canvas.setTextColor(ST77XX_WHITE);
    for (uint8_t a=0x01; a<=0x7F; a++) {
      if (TB.scanI2CBus(a, 0)) {
        canvas.print("0x");
        canvas.print(a, HEX);
        canvas.print(", ");
      }
    }
    display.drawRGBBitmap(0, 0, canvas.getBuffer(), 240, 135);
    pinMode(TFT_BACKLITE, OUTPUT);
    digitalWrite(TFT_BACKLITE, HIGH);
  }

  TB.setColor(TB.Wheel(j++));
  delay(10);
  return;
}

```

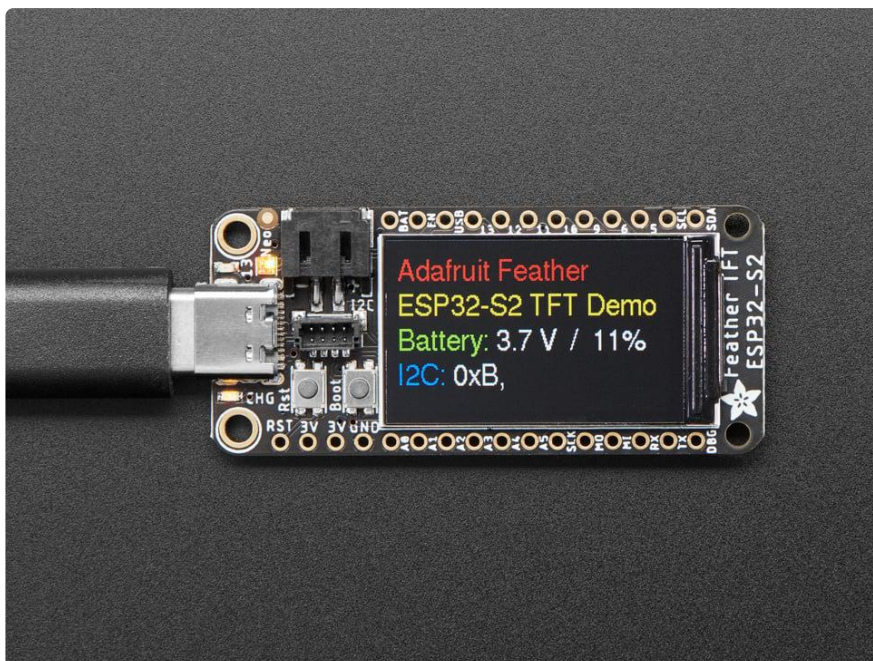

Open the serial monitor to see the data printed out.



Now your Feather TFT is back to the state in which it shipped! And, loading it from code allows you to learn more, or change it to do something different.

WipperSnapper Setup

The WipperSnapper firmware and ecosystem are in BETA and are actively being developed to add functionality, more boards, more sensors, and fix bugs. We encourage you to try out WipperSnapper with the understanding that it is not final release software and is still in development.

If you encounter any bugs, glitches, or difficulties during the beta period, or with this guide, please contact us via <http://io.adafruit.com/support>

What is WipperSnapper

WipperSnapper is a firmware designed to turn any WiFi-capable board into an Internet-of-Things device without programming a single line of code. WipperSnapper connects to [Adafruit IO \(\)](#), a web platform designed [\(by Adafruit! \(\)\)](#) to display, respond, and interact with your project's data.

Simply load the WipperSnapper firmware onto your board, add credentials, and plug it into power. Your board will automatically register itself with your Adafruit IO account.

From there, you can add components to your board such as buttons, switches, potentiometers, sensors, and more! Components are dynamically added to hardware, so you can immediately start interacting, logging, and streaming the data your projects produce without writing code.

Sign up for Adafruit.io

You will need an Adafruit IO account to use WipperSnapper on your board. If you do not already have one, head over to [io.adafruit.com \(\)](http://io.adafruit.com) to create a free account.

Add a New Device to Adafruit IO

Log into your [Adafruit IO \(\)](#) account. Click the New Device button at the top of the page.

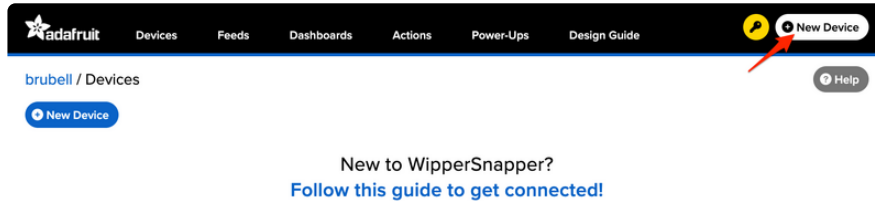

After clicking New Device, you should be on the board selector page. This page displays every board that is compatible with the WipperSnapper firmware.

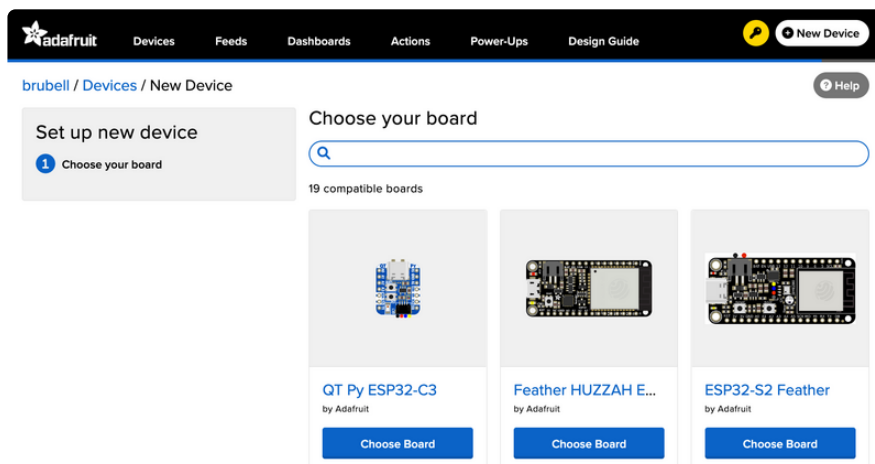

In the board selector page's search bar, search for the ESP32-S2 TFT Feather. Once you've located the board you'd like to install WipperSnapper on, click the Choose Board button to bring you to the self-guided installation wizard.

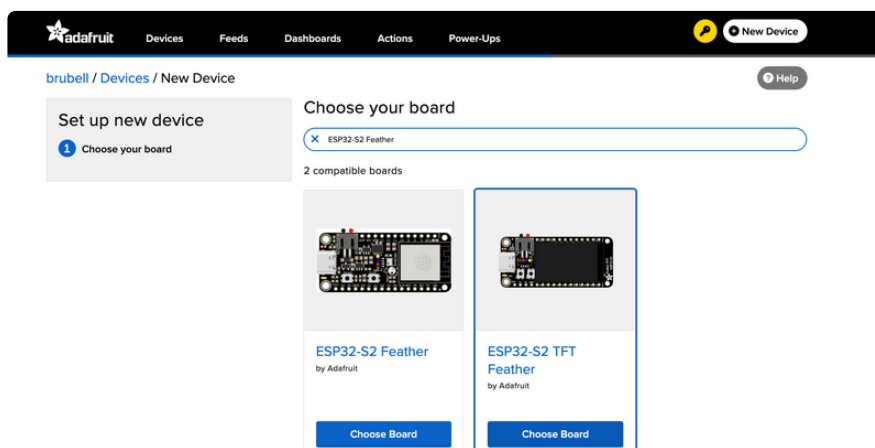

Follow the step-by-step instructions on the page to install Wippersnapper on your device and connect it to Adafruit IO.

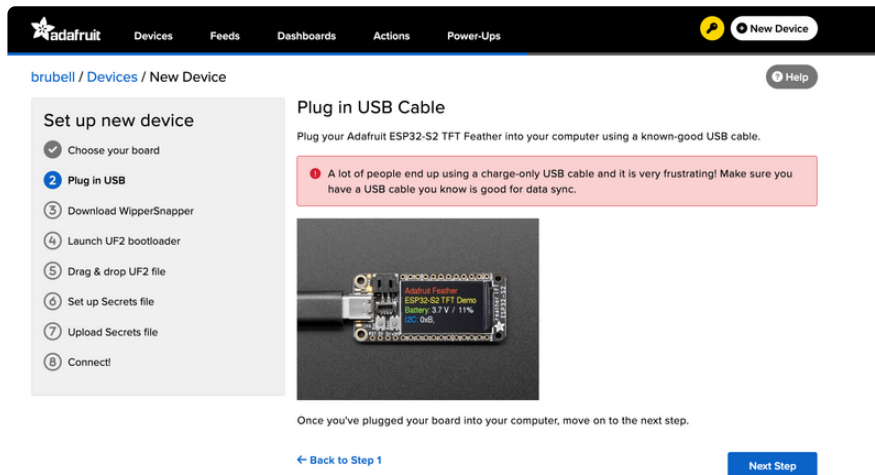

If the installation was successful, a popover should appear displaying that your board has successfully been detected by Adafruit IO.

Give your board a name and click "Continue to Device Page".

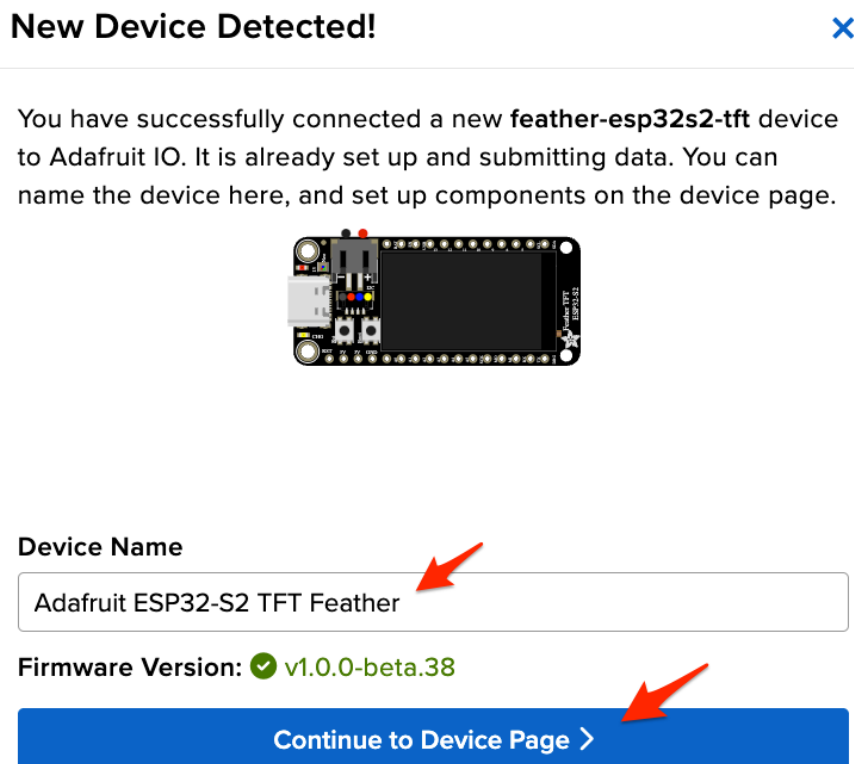

You should be brought to your board's device page.

Next, Visit this guide's WipperSnapper Essentials pages to learn how to interact with your board using Adafruit IO.

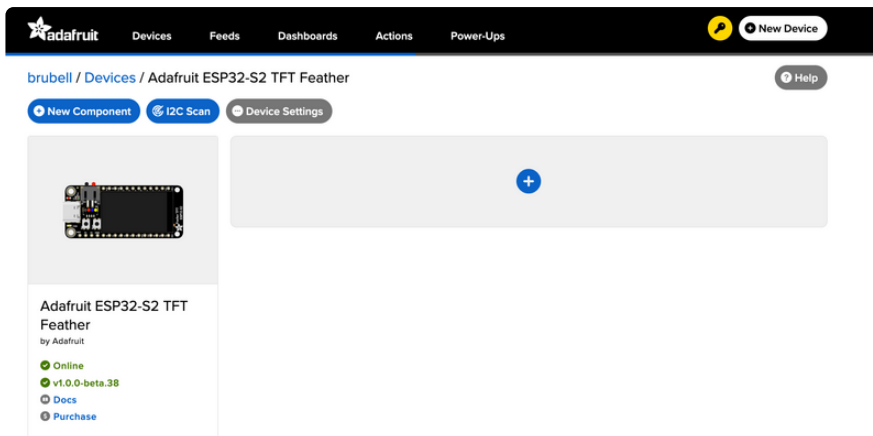

Feedback

Adafruit.io WipperSnapper is in beta and you can help improve it!

If you have suggestions or general feedback about the installation process - visit <https://io.adafruit.com/support> (), click "Contact Adafruit IO Support" and select "I have feedback or suggestions for the WipperSnapper Beta".

Troubleshooting

If you encountered an issue during installation, please try the steps below first.

If you're still unable to resolve the issue, or if your issue is not listed below, get in touch with us directly at <https://io.adafruit.com/support> (). Make sure to click "Contact Adafruit IO Support" and select "There is an issue with WipperSnapper. Something is broken!"

I don't see my board on Adafruit IO, it is stuck connecting to WiFi

First, make sure that you selected the correct board on the board selector.

Next, please make sure that you entered your WiFi credentials properly, there are no spaces/special characters in either your network name (SSID) or password, and that you are connected to a 2.4GHz wireless network.

If you're still unable to connect your board to WiFi, please [make a new post on the WipperSnapper technical support forum with the error you're experiencing, the LED colors which are blinking, and the board you're using.](#) ()

I don't see my board on Adafruit IO, it is stuck "Registering with Adafruit IO"

Try hard-resetting your board by unplugging it from USB power and plugging it back in.

If the error is still occurring, please [make a new post on the WipperSnapper technical support forum with information about what you're experiencing, the LED colors which are blinking \(if applicable\), and the board you're using.](#) ()

"Uninstalling" WipperSnapper

WipperSnapper firmware is an application that is loaded onto your board. There is nothing to "uninstall". However, you may want to "move" your board from running WipperSnapper to running Arduino or CircuitPython. You also may need to restore your board to the state it was shipped to you from the Adafruit factory.

Moving from WipperSnapper to CircuitPython

Follow the steps on the [Installing CircuitPython page](#) () to install CircuitPython on your board running WipperSnapper.

- If you are unable to double-tap the RST button to enter the UF2 bootloader, follow the "Factory Resetting a WipperSnapper Board" instructions below.

Uploading this sketch will overwrite WipperSnapper. If you want to re-install WipperSnapper, follow the instructions at the top of this page.

Moving from WipperSnapper to Arduino

If you want to use your board with Arduino, you will use the Arduino IDE to load any sketch onto your board.

First, follow the page below to set up your Arduino IDE environment for use with your board.

[Setup Arduino IDE](#)

Then, follow the page below to upload the "Arduino Blink" sketch to your board.

Upload Arduino "Blink" Sketch

Uploading this sketch will overwrite WipperSnapper. If you want to re-install WipperSnapper, follow the instructions at the top of this page.

Factory Resetting a WipperSnapper Board

Sometimes, hardware gets into a state that requires it to be "restored" to the original state it shipped in. If you'd like to get your board back to its original factory state, follow the guide below.

Factory Reset Adafruit ESP32-S2
TFT Feather

WipperSnapper Essentials

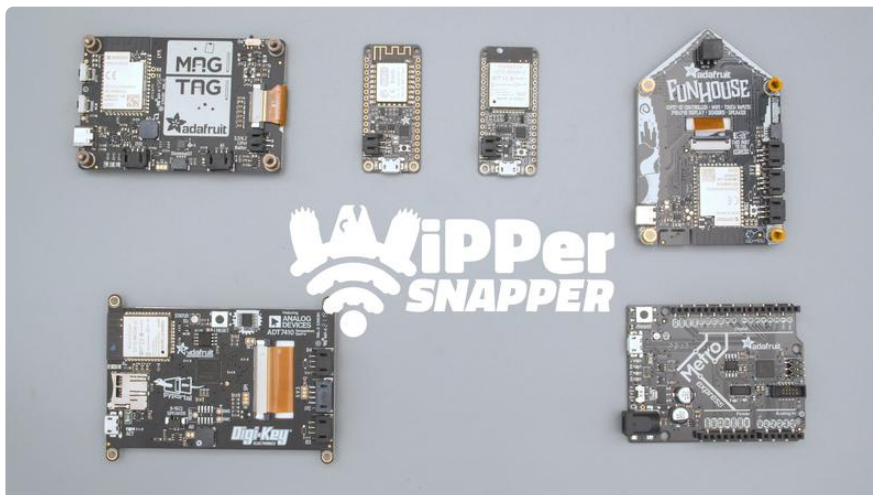

You've installed WipperSnapper firmware on your board and connected it to Adafruit IO. Next, to learn how to use Adafruit IO!

The Adafruit IO supports a large number of components. Components are physical parts such as buttons, switches, sensors, servos, LEDs, RGB LEDs, and more.

The following pages will get you up and running with WipperSnapper as you interact with your board's LED, read the value of a push button, send the value of an I2C sensor to the internet, and wirelessly control colorful LEDs.

LED Blink

In this demo, we show controlling an LED from Adafruit IO. But the same kind of control can be used for relays, lights, motors, or solenoids.

One of the first programs you typically write to get used to embedded programming is a sketch that repeatably blinks an LED. IoT projects are wireless, so after completing this section, you'll be able to turn on (or off) the LED built into your board from anywhere in the world.

Where is the LED on my board?

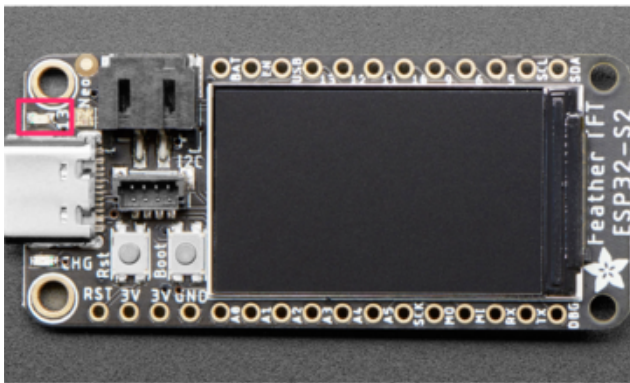

The ESP32-S2 TFT Feather has a red LED located directly above the USB-C port, highlighted in pink.

Create a LED Component on Adafruit IO

On the device page, click the New Component (or "+") button to open the component picker.

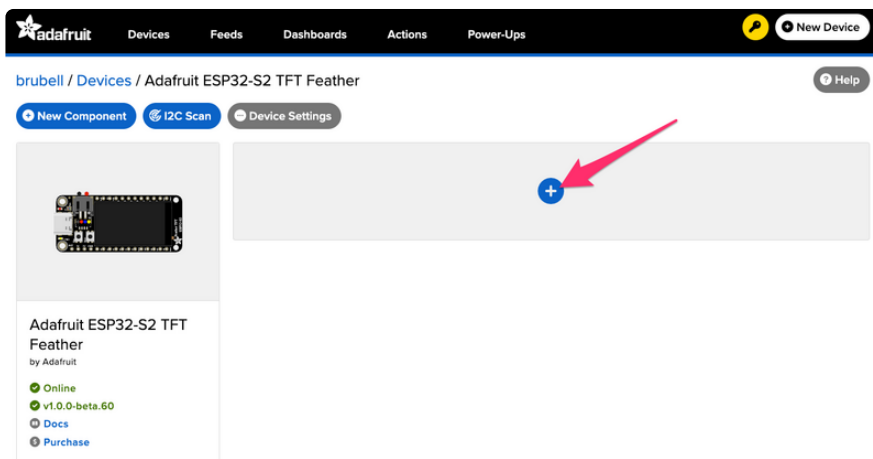

From the component picker, select the LED.

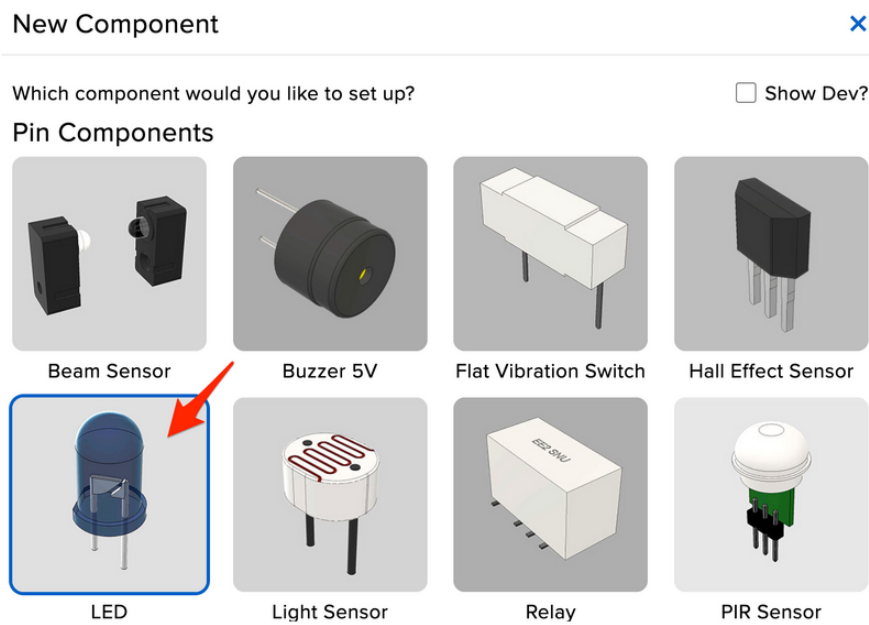

On the Create LED Component form, the board's LED pin is pre-selected.

Click Create Component.

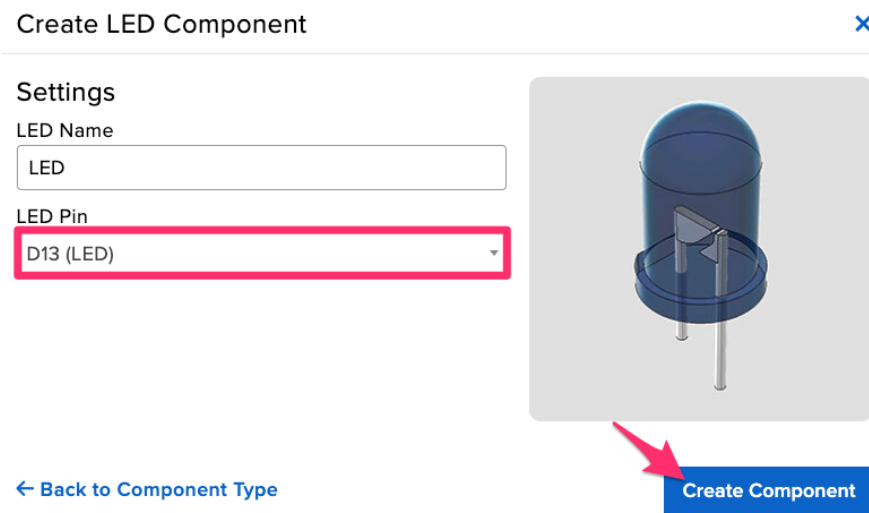

Behind the scenes, Adafruit IO sends send a command to your board running WipperSnapper telling it to configure "LED Pin" as a digital output.

Your board's page on Adafruit IO shows a new LED component.

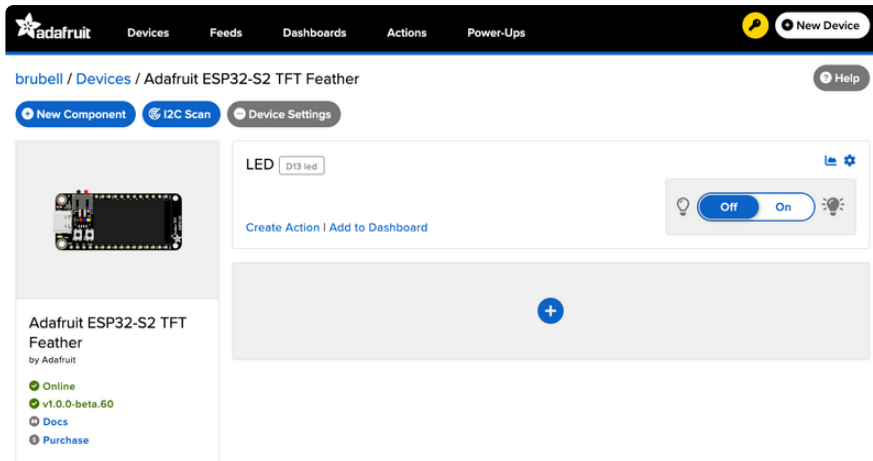

Usage

On the board page, toggle the LED component by clicking the toggle switch. This should turn your board's built-in LED on or off.

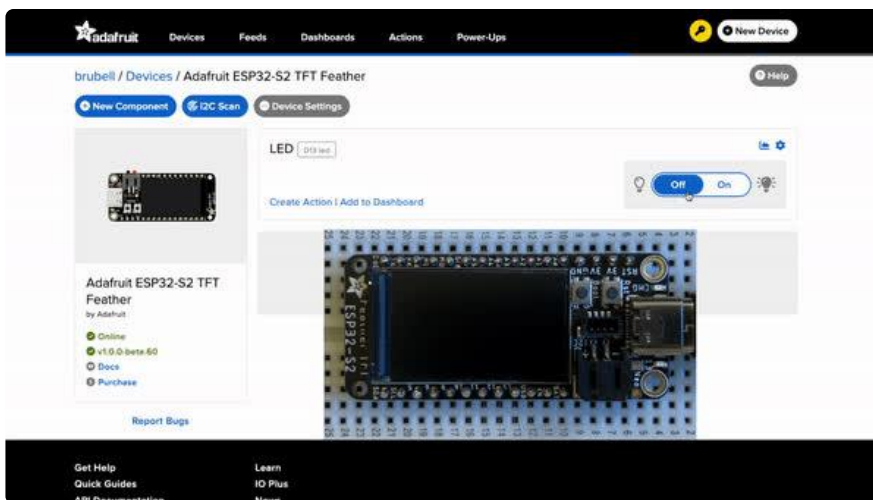

NeoPixel LED

Your board has a WS281x RGB LED (NeoPixel, in Adafruit jargon) built in. Boards running the WipperSnapper firmware can be wirelessly controlled by Adafruit IO to interact with NeoPixels.

On this page, you'll learn how to change the color and brightness of the NeoPixel built into your board from Adafruit IO.

Where is the NeoPixel on my board?

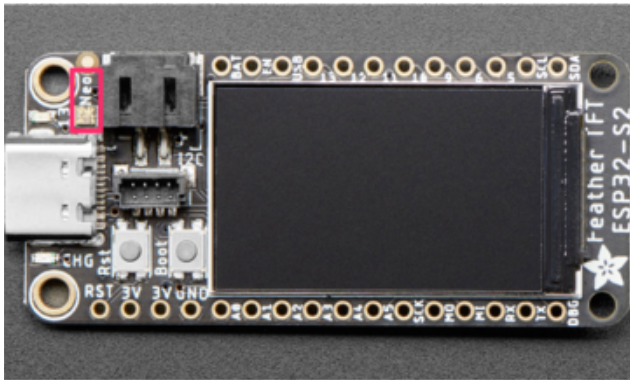

The Adafruit ESP32-S2 TFT Feather has a NeoPixel located above the JST connector, highlighted in pink.

Create the NeoPixel Component

On the device page, click the New Component (or "+") button to open the component picker.

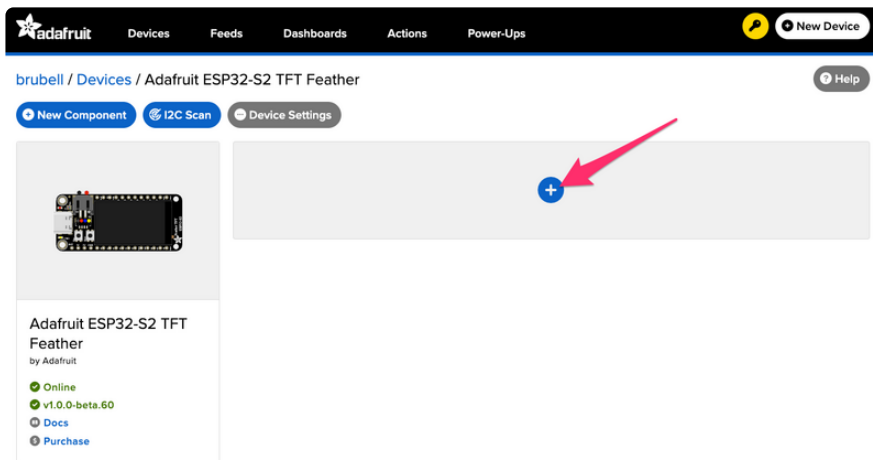

Under the Pixel Components header on the component picker, click NeoPixel.

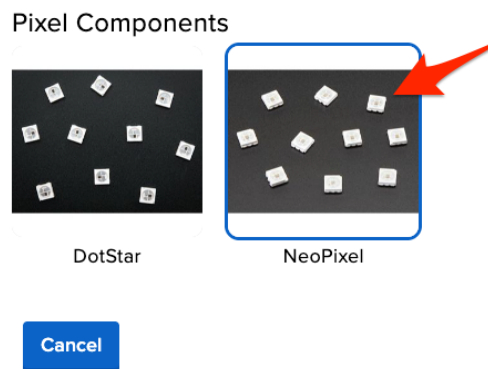

The board NeoPixel pin is automatically found and selected.

Click Create Component

Create NeoPixel Component ✕

Settings

NeoPixel Name

NeoPixel Pin

Number of Pixels

Color Order

Brightness

[← Back to Component Type](#) Create Component

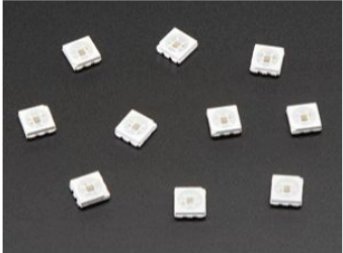

Behind the scenes, Adafruit IO sends a command to your board running WipperSnapper firmware telling it to configure the pin as a NeoPixel component with the settings from the form.

The Device page shows the NeoPixel component.

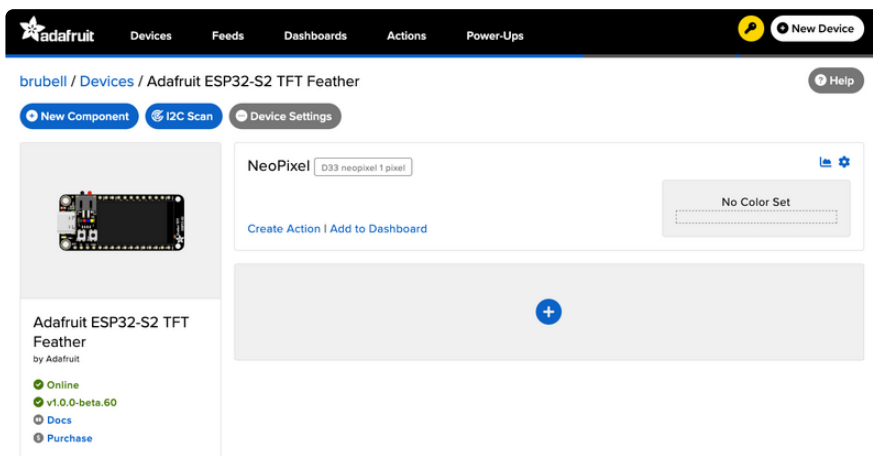

Set the NeoPixel's RGB Color

Since no colors have been set yet, the color picker's default value is `#000000` (black in hex color code) and appears "off". Let's change that to make the NeoPixel shine brightly!

On the NeoPixel component, click the gray "No Color Set" button.

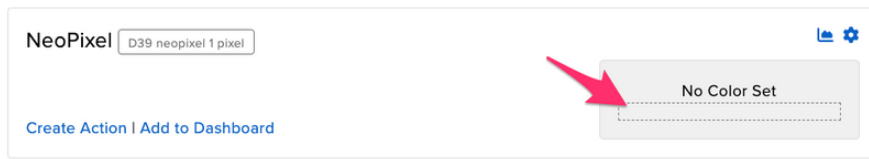

A color picker pops open! Next, let's learn how Adafruit IO uses hex color codes to represent the colors on your NeoPixel.

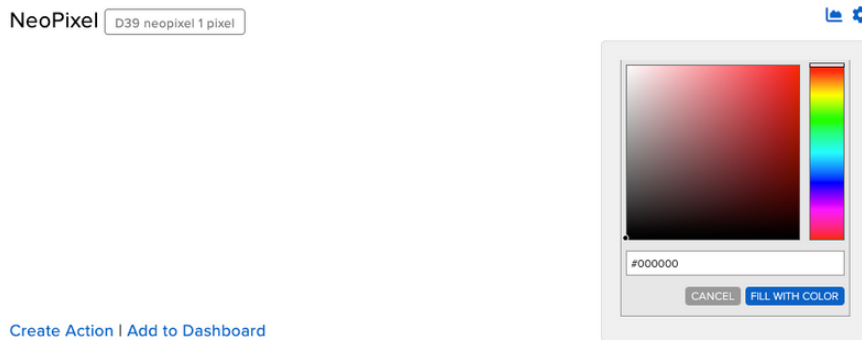

Hex Colors 101

The color picker on Adafruit IO uses hex color codes to represent Red, Green, and Blue values. For example, `#FF0000` is the hex color code for the color red. The colors (`#FF0000`) red component is `FF` (255 translated to decimal), the green component is `00` and the blue component is `00`. Translated to RGB format, the color is `RGB (255, 0, 0)`.

Using the color picker, or by manually entering a hex color code, select a color.



When you're ready to set the color of your device's NeoPixel, click FILL WITH COLOR. The NeoPixel will immediately glow!

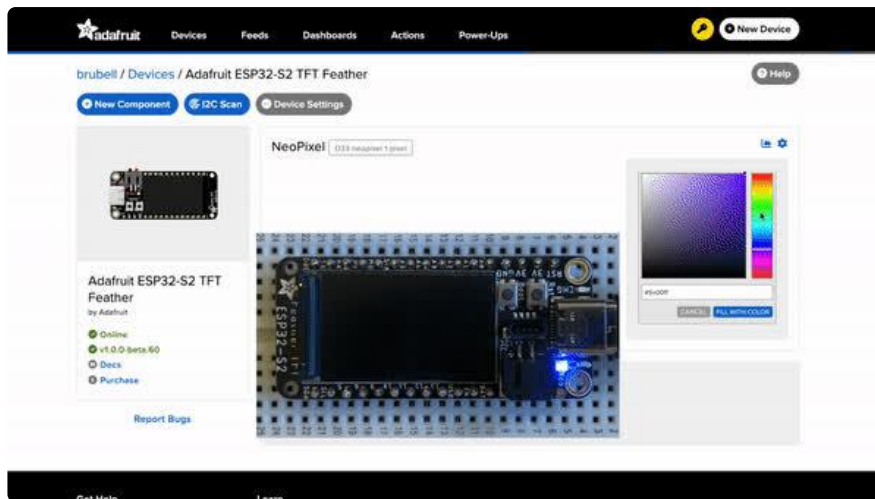

Set NeoPixel Brightness

If the NeoPixel is too bright (or too dim), you can change its brightness. Click the gear/cog icon on the NeoPixel component to open its settings.

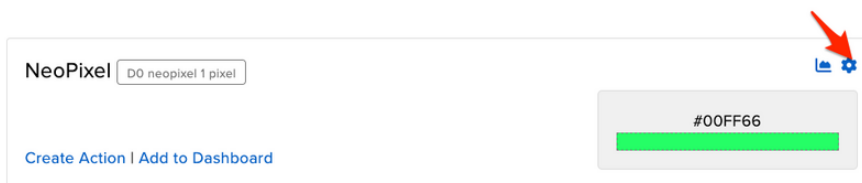

On the NeoPixel component form, set Brightness to a value between 0 (fully off) and 255 (full brightness).

Click the Update Component button to send the updated configuration to your device.

Settings

NeoPixel Name

NeoPixel Pin

Number of Pixels

Color Order

Brightness

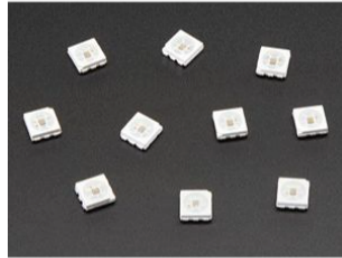
[← Change Component Type](#)[Update Component](#)

Read a Push-button

In this demo, we show reading the state of a push-button from WipperSnapper. But the same kind of control can be used for reading switches, break beam sensors, and other digital sensors.

You can configure a board running WipperSnapper to read data from standard input buttons, switches, or digital sensors, and send the value to Adafruit IO.

From Adafruit IO, you will configure one of the pushbuttons on your board as a push button component. Then, when the button is pressed (or released), a value will be published to Adafruit IO.

Button Location

This example uses the board's built-in push-button and internal pull-up resistor instead of wiring a push-button up.

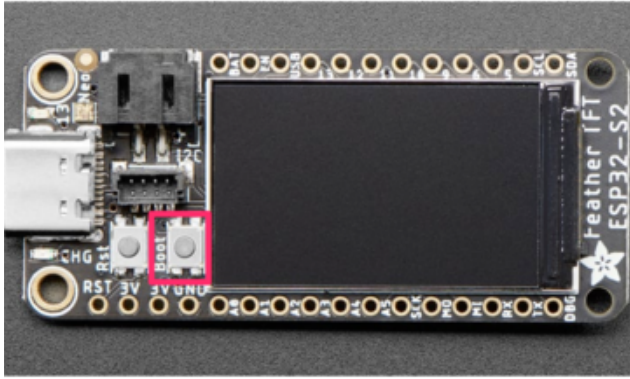

The ESP32-S2 TFT Feather's push button we're using in this example is located directly next to the TFT. On the silkscreen, it is identified as BOOT.

Create a Push-button Component on Adafruit IO

On the device page, click the New Component (or "+") button to open the component picker.

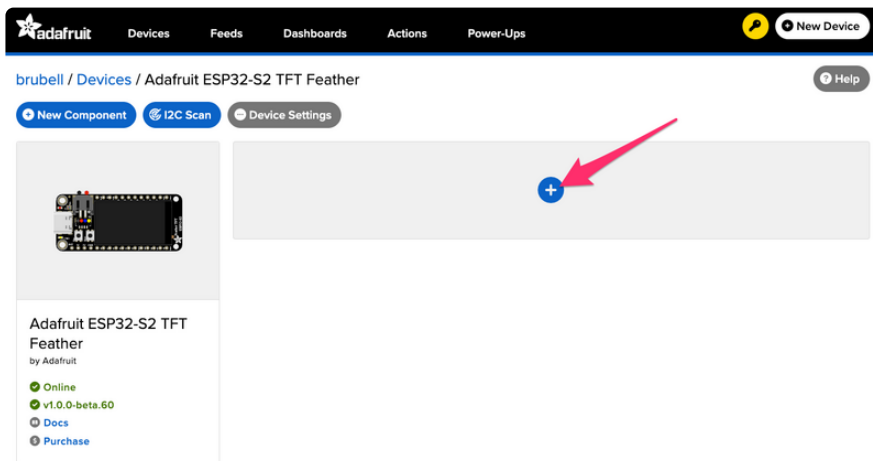

From the component picker, select the Push Button.

New Component



Which component would you like to set up?

Show Dev?

Pin Components



Beam Sensor

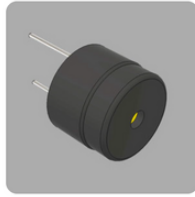

Buzzer 5V

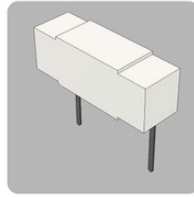

Flat Vibration Switch

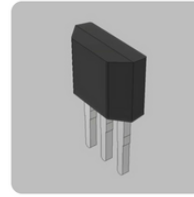

Hall Effect Sensor



LED

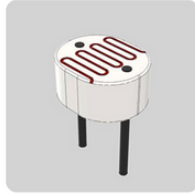

Light Sensor

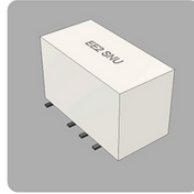

Relay

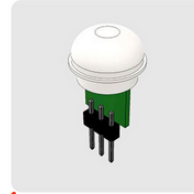

PIR Sensor



Potentiometer



Power Switch

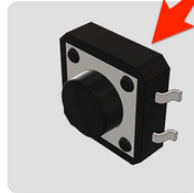

Push Button

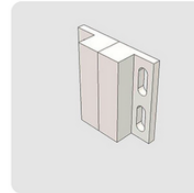

Reed Switch

The "Create Push Button Component" form presents you with options for configuring the push button.

Start by selecting the board's pin connected to the push button.

Create Push Button Component



Settings

Push Button Name

Push Button Pin

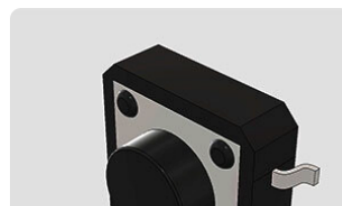

The Return Interval dictates how frequently the value of the push-button will be sent from the board to Adafruit IO.

For this example, you will configure the push button's value to be only sent when the value changes (i.e. when it's either pressed or depressed).

Create Push Button Component



Settings

Push Button Name

Push Button Pin

Return Interval

- On Change
 Periodically

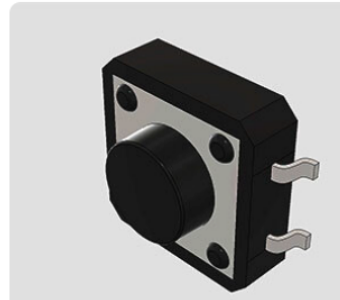

Finally, check the Specify Pin Pull Direction checkbox and select the pull direction.

Create Push Button Component



Settings

Push Button Name

Push Button Pin

Return Interval

- On Change
 Periodically
 Specify Pin Pull Direction?

- Pull Up
 Pull Down



Make sure the form's settings look like the following screenshot. Then, click Create Component.

Create Push Button Component



Settings

Push Button Name

Push Button Pin

Return Interval

- On Change
 Periodically
 Specify Pin Pull Direction?

- Pull Up
 Pull Down



[← Back to Component Type](#)

[Create Component](#)

Adafruit IO sends a command to your WipperSnapper board, telling it to configure the GPIO pin you selected to behave as a digital input pin and to enable it to pull up the internal resistor.

Your board's page should also show the new push-button component.

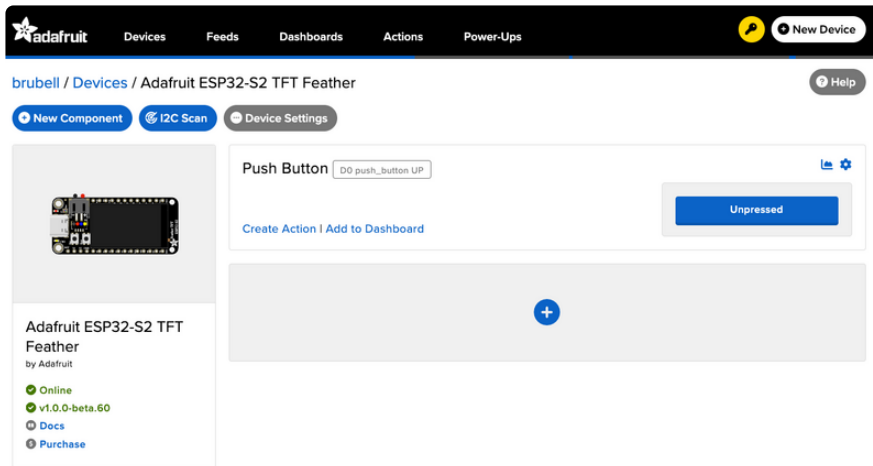

Push the button on your board to change the value of the push-button component on Adafruit IO.

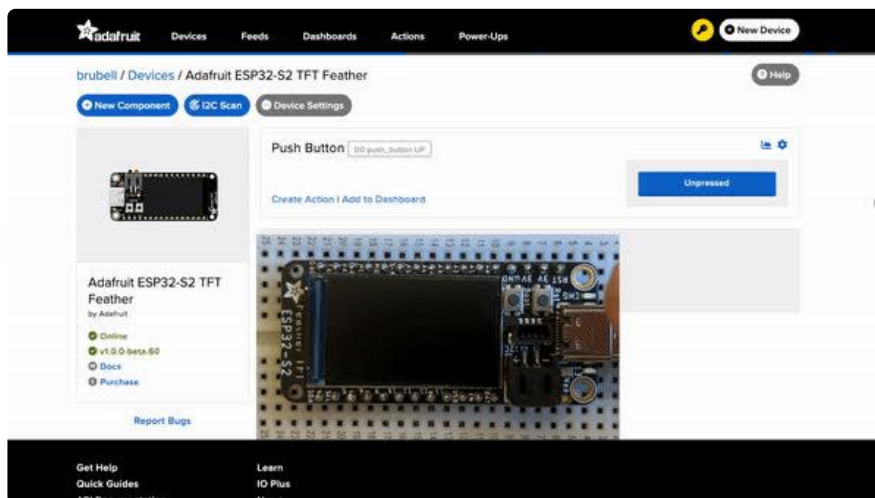

Analog Input

Your microcontroller board has both digital and analog signal capabilities. Some pins are analog, some are digital, and some are capable of both. Check the Pinouts page in this guide for details about your board.

Analog signals are different from digital signals in that they can be any voltage and can vary continuously and smoothly between voltages. An analog signal is like a dimmer switch on a light, whereas a digital signal is like a simple on/off switch.

Digital signals only can ever have two states, they are either on (high logic level voltage like 3.3V) or off (low logic level voltage like 0V / ground).

By contrast, analog signals can be any voltage in-between on and off, such as 1.8V or 0.001V or 2.98V and so on.

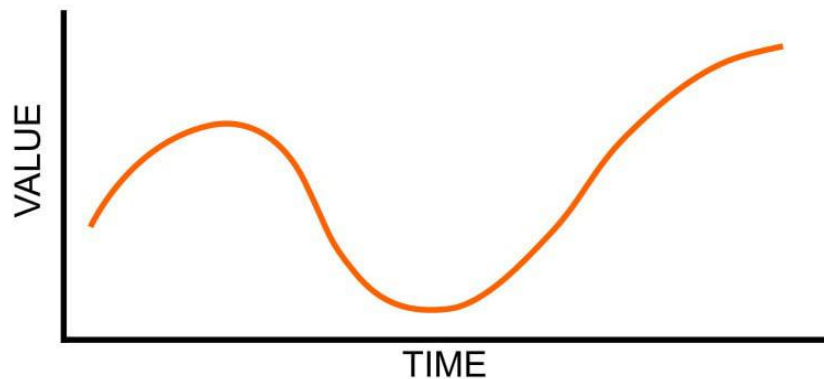

Analog signals are continuous values which means they can be an infinite number of different voltages. Think of analog signals like a floating point or fractional number, they can smoothly transiting to any in-between value like 1.8V, 1.81V, 1.801V, 1.8001V, 1.80001V and so forth to infinity.

Many devices use analog signals, in particular sensors typically output an analog signal or voltage that varies based on something being sensed like light, heat, humidity, etc.

Analog to Digital Converter (ADC)

An analog-to-digital-converter, or ADC, is the key to reading analog signals and voltages with a microcontroller. An ADC is a device that reads the voltage of an analog signal and converts it into a digital, or numeric, value. The microcontroller can't read analog signals directly, so the analog signal is first converted into a numeric value by the ADC.

The black line below shows a digital signal over time, and the red line shows the converted analog signal over the same amount of time.

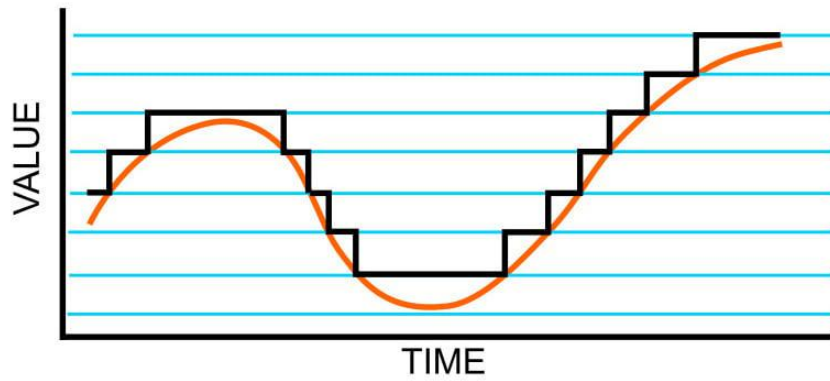

Once that analog signal has been converted by the ADC, the microcontroller can use those digital values any way you like!

Potentiometers

A potentiometer is a small variable resistor that you can twist a knob or shaft to change its resistance. It has three pins. By twisting the knob on the potentiometer you can change the resistance of the middle pin (called the wiper) to be anywhere within the range of resistance of the potentiometer.

By wiring the potentiometer to your board in a special way (called a voltage divider) you can turn the change in resistance into a change in voltage that your board's analog to digital converter can read.

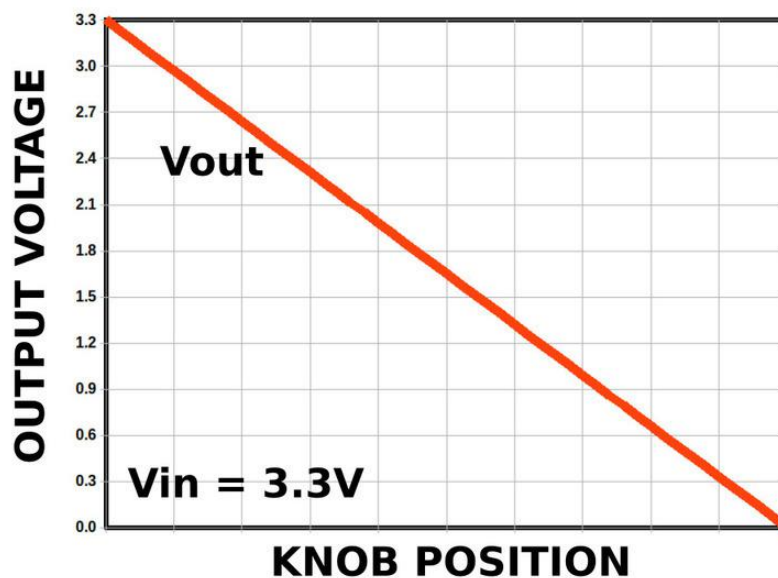

To wire up a potentiometer as a voltage divider:

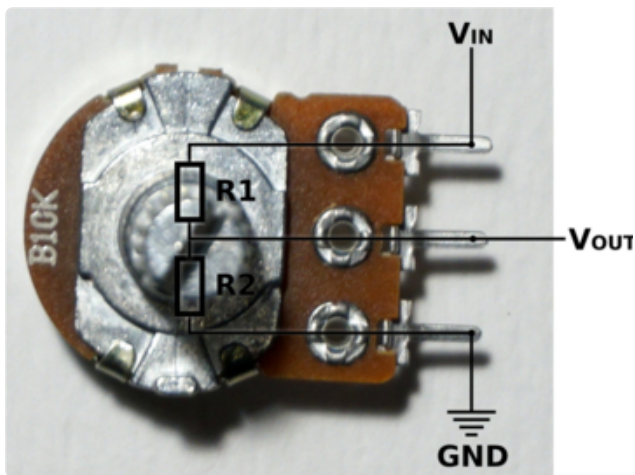

Connect one outside pin to ground
Connect the other outside pin to voltage in
(e.g. 3.3V)
Connect the middle pin to an analog pin
(e.g. A0)

Hardware

In addition to your microcontroller board, you will need the following hardware to follow along with this example.

Potentiometer

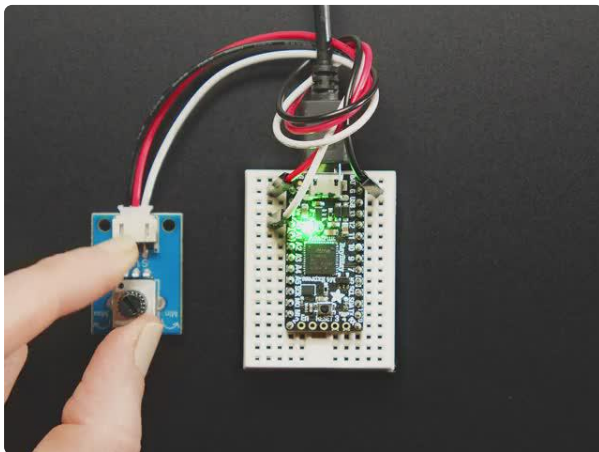

[STEMMA Wired Potentiometer Breakout Board - 10K ohm Linear](https://www.adafruit.com/product/4493)

For the easiest way possible to measure twists, turn to this STEMMA potentiometer breakout (ha!). This plug-n-play pot comes with a JST-PH 2mm connector and a matching

<https://www.adafruit.com/product/4493>

Wire Up the Potentiometer

Connect the potentiometer to your board as follows.

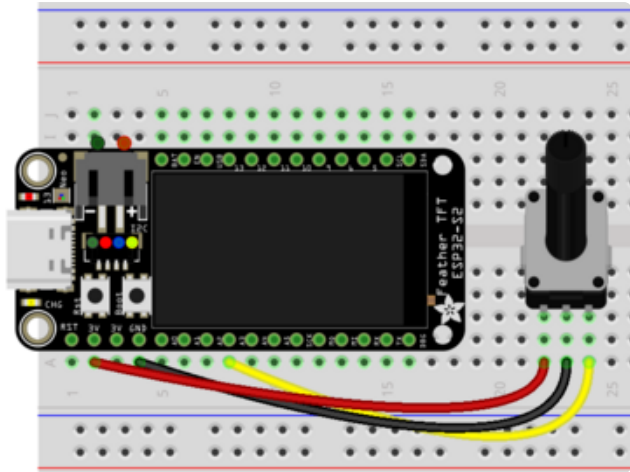

Feather 3.3V to potentiometer left pin
Feather A2 to potentiometer middle pin
Feather GND to potentiometer right pin

Create a Potentiometer Component on Adafruit IO

On the device page, click the New Component (or "+") button to open the component picker.

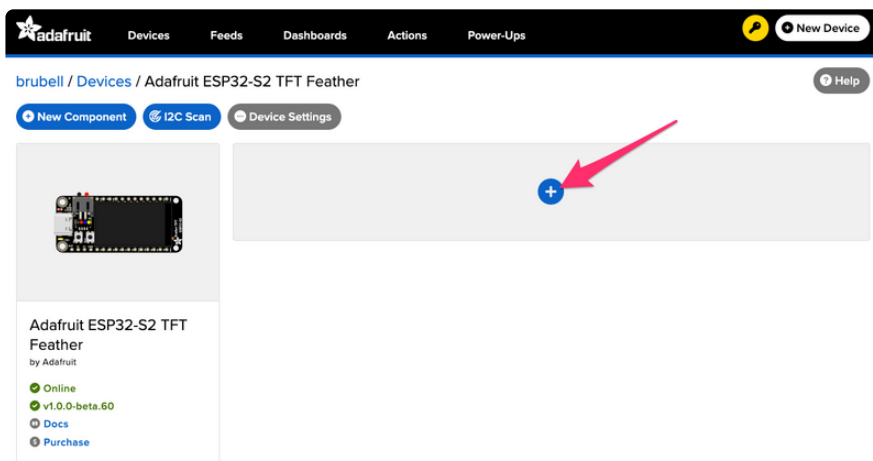

On the component picker, click the potentiometer.

New Component



Which component would you like to set up?

Show Dev?

Pin Components

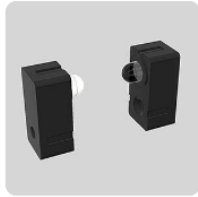

Beam Sensor

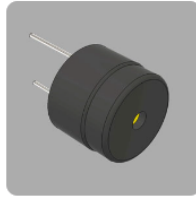

Buzzer 5V

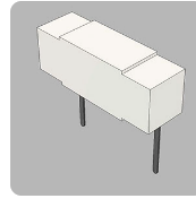

Flat Vibration Switch

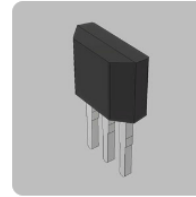

Hall Effect Sensor

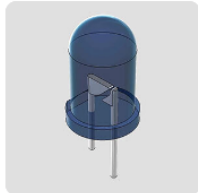

LED



Light Sensor

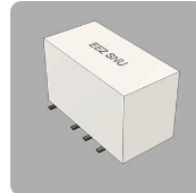

Relay

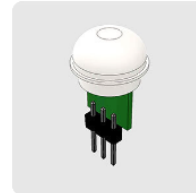

PIR Sensor



Potentiometer



Power Switch



Push Button

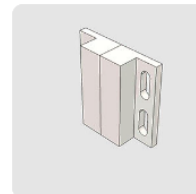

Reed Switch

On the Create Potentiometer Component form:

- Set Potentiometer Pin to A2
- Select "On Change" as the Return Interval
- Select Raw Analog Value as the Return Type

Then, click Create Component

Create Potentiometer Component



Settings

Potentiometer Name

Potentiometer

Potentiometer Pin

A2

Return Interval

On Change

Periodically

Return Type

Raw Analog Value

Voltage



[← Back to Component Type](#)

[Create Component](#)

The potentiometer component appears on your board page! Next, learning to read values from it.

brubell / Devices / Adafruit ESP32-S2 TFT Feather

New Component I2C Scan Device Settings Help

Potentiometer A16 potentiometer

Value: 35272.00

Create Action | Add to Dashboard

Adafruit ESP32-S2 TFT Feather by Adafruit

- Online
- v1.0.0-beta.60
- Docs
- Purchase

Read Analog Pin Values

Rotate the potentiometer to see the value change.

Potentiometer A34 potentiometer

Value: 0.00

Create Action | Add to Dashboard

What do these values mean?

WipperSnapper reports ADC "raw values" as 16-bit unsigned integer values. Your potentiometer will read between 0 (twisting the pot to the leftmost position) and 65535 (twisting the pot to the rightmost position).

Read Analog Pin Voltage Values

You can update the potentiometer component (or any analog pin component in WipperSnapper) to report values in Volts. To do this, on the right-hand side of the potentiometer component, click the cog button.

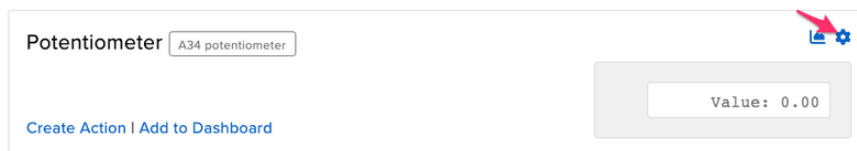

Under Return Type, click Voltage.

Click Update Component to send the updated component settings to your board running WipperSnapper.



Now, twist the potentiometer to see the value reported to Adafruit IO in Volts!

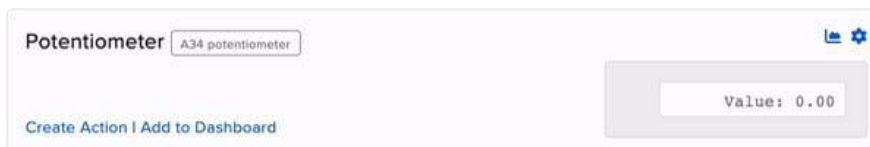

I2C Sensors

While this page uses the "MCP9808 High Accuracy I2C Temperature Sensor Breakout", the process for adding an I2C sensor to your board running WipperSnapper is similar for all I2C sensors.

Inter-Integrated Circuit, aka I2C, is a two-wire protocol for connecting sensors and "devices" to a microcontroller. A large number of sensors, including the ones sold by Adafruit, use I2C to communicate.

Typically, using I2C with a microcontroller involves programming. Adafruit IO and WipperSnapper let you configure a microcontroller to read data from an I2C sensor and publish that data to the internet without writing code.

The WipperSnapper firmware supports a number of I2C sensors, [viewable in list format here](#) ().

- If you do not see the I2C sensor you're attempting to use with WipperSnapper, [Adafruit has a guide on adding a component to Adafruit IO WipperSnapper here](#) ().

On this page, you'll learn how to wire up an I2C sensor to your board. Then, you'll create a new component on Adafruit IO for your I2C sensor and send the sensor values to Adafruit IO. Finally, you'll learn how to locate, interpret, and download the data produced by your sensors.

Parts

You will need the following parts to complete this page:

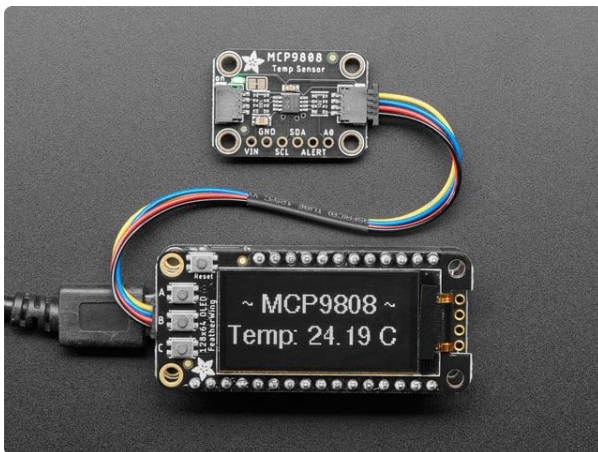

[Adafruit MCP9808 High Accuracy I2C Temperature Sensor Breakout](#)

The MCP9808 digital temperature sensor is one of the more accurate/precise we've ever seen, with a typical accuracy of $\pm 0.25^{\circ}\text{C}$ over the sensor's -40°C to... <https://www.adafruit.com/product/5027>

Wiring

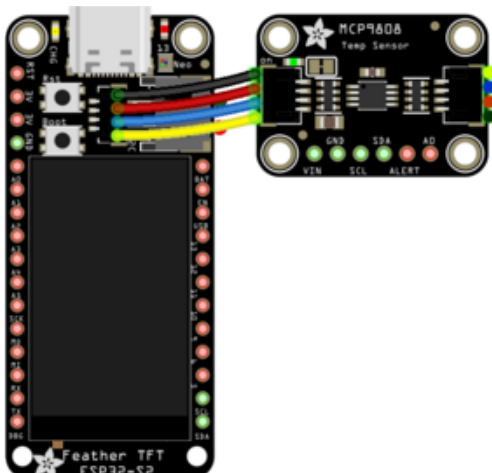

Connect the Board STEMMA QT Port to the MCP9808's STEMMA QT Port

Add an MCP9808 Component

On the device page, click the New Component (or "+") button to open the component picker.

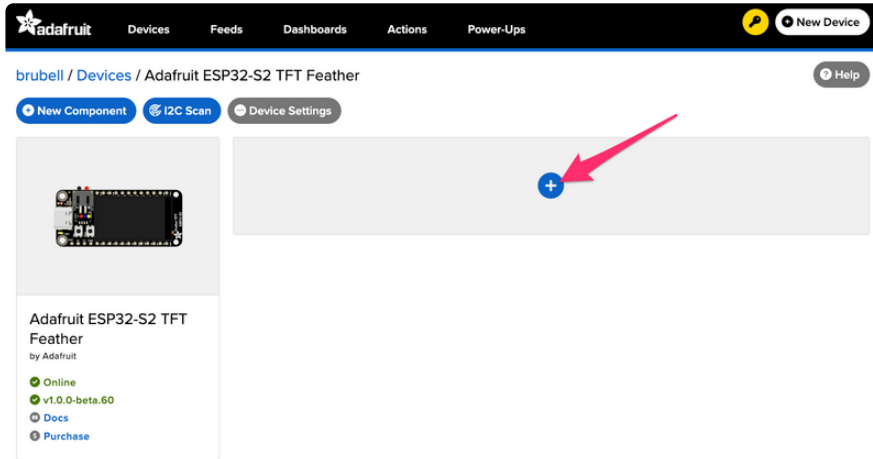

Under the I2C Components header, click MCP9808.

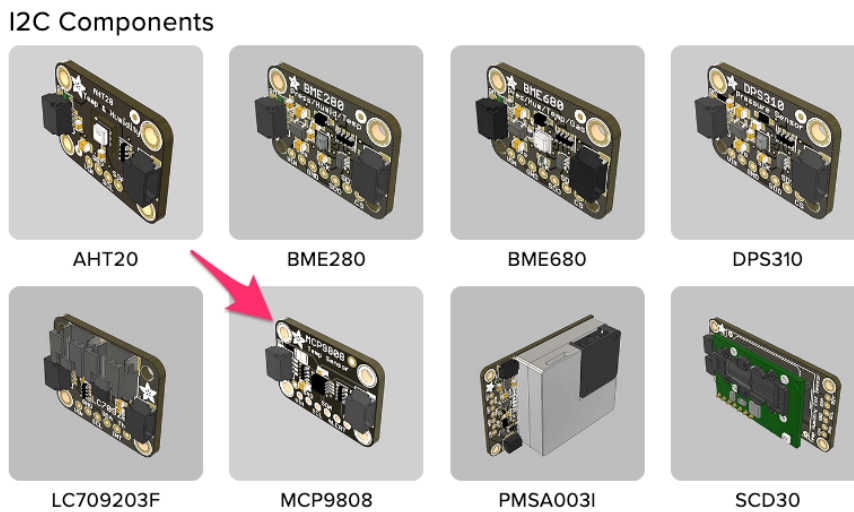

On the component configuration page, the MCP9808's I2C sensor address should be listed along with the sensor's settings.

Create MCP9808 Component



Select I2C Address:

0x18

Enable MCP9808: Temperature Sensor (°C)?

Name:

MCP9808: Temperature Sensor (°C)

Send Every:

Every 15 minutes

Enable MCP9808: Temperature Sensor (°F)?

Name:

MCP9808: Temperature Sensor (°F)

Send Every:

Every 15 minutes

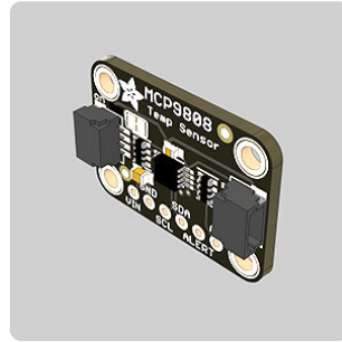

The MCP9808 sensor can measure ambient temperature. This page has individual options for reading the ambient temperature, in either Celsius or Fahrenheit. You may select the readings which are appropriate to your application and region.

The Send Every option is specific to each sensor measurement. This option will tell the board how often it should read from the sensor and send the data to Adafruit IO. Measurements can range from every 30 seconds to every 24 hours.

For this example, set the Send Every interval for both seconds to Every 30 seconds. Click Create Component.

Create MCP9808 Component



Select I2C Address:

0x18

Enable MCP9808: Temperature Sensor (°C)?

Enable MCP9808: Temperature Sensor (°F)?

Name:

MCP9808: Temperature Sensor (°F)

Send Every:

Every 30 seconds

[← Back to Component Type](#)

[Create Component](#)

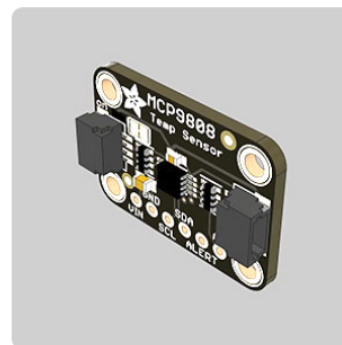

The board page should now show the MCP9808 component you created. After the interval you configured elapses, the WipperSnapper firmware running on your board automatically reads values from the sensor and sends them to Adafruit IO.

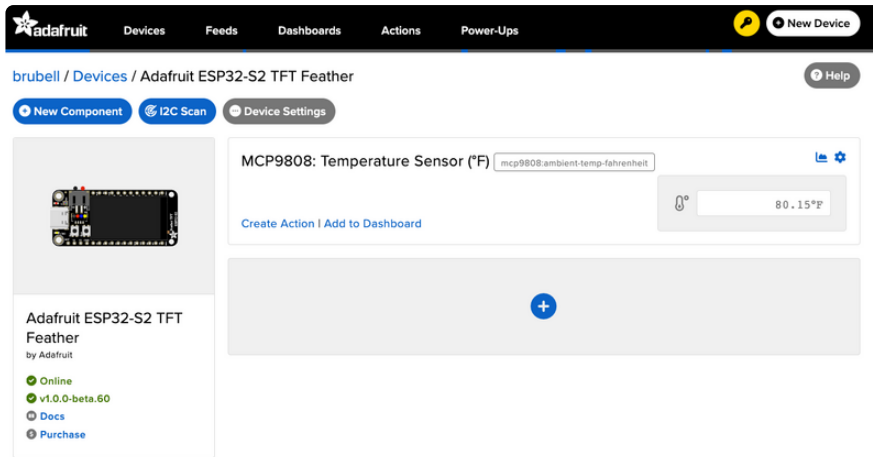

Read I2C Sensor Values

Now to look behind the scenes at a powerful element of using Adafruit IO and WipperSnapper. When a new component is created on Adafruit IO, an [Adafruit IO Feed \(\)](#) is also created. This Feed holds your sensor component values for long-term storage (30 days of storage for Adafruit IO Free and 60 days for Adafruit IO Plus plans).

Aside from holding the values read by a sensor, the component's feed also holds metadata about the data pushed to Adafruit IO. This includes settings for whether the data is public or private, what license the stored sensor data falls under, and a general description of the data.

Next, to look at the sensor temperature feed. To navigate to a component's feed, click on the chart icon in the upper-right-hand corner of the component.



On the component's feed page, you'll see each data point read by your sensor and when they were reported to Adafruit IO.

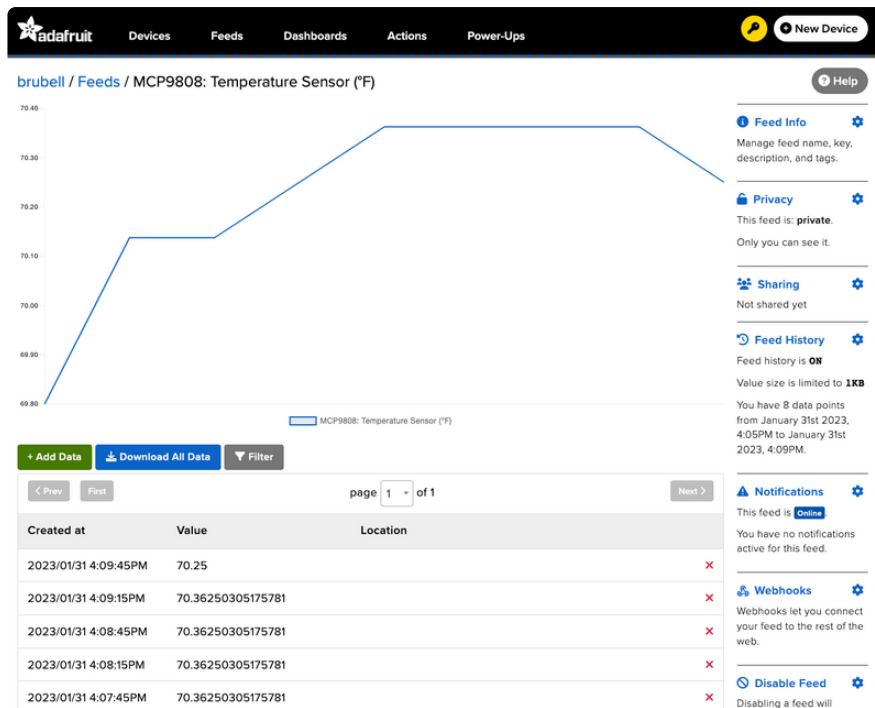

Doing more with your sensor's Adafruit IO Feed

This only scratches the surface of what Adafruit IO Feeds can accomplish for your IoT projects. For a complete overview of Adafruit IO Feeds, including tasks like downloading feed data, sharing a feed, removing erroneous data points from a feed, and more, [head over to the "Adafruit IO Basics: Feed" learning guide \(\)](#).

Battery Monitor (MAX17048)

There are two ways to power your Feather:

- 1) Power with a USB Cable connected to a power source.
- 2) Connect a 4.2/3.7V Lithium Polymer (LiPo/LiPoly) or Lithium Ion (Lilon) battery to the JST jack. This lets you run the Feather without wires, untethered!

If you're running off of a battery, chances are you want to know what the voltage is! That way you can tell when the battery needs recharging.

In this section, you'll connect a battery to your Feather, and configure a battery monitor component from Adafruit IO to report the board's battery voltage and charge percentage.

Where is the Battery Monitor on my Feather?

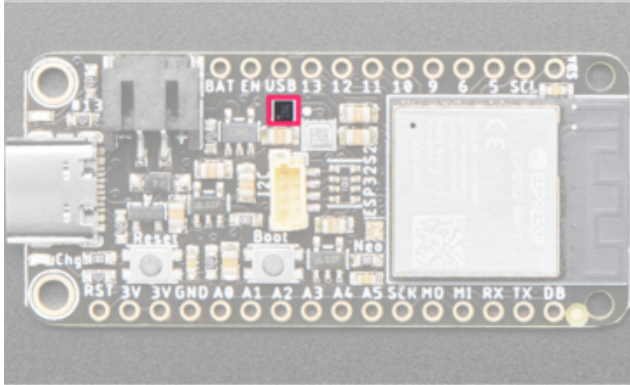

The Feather's MAX17048 Battery Monitor is located directly above the STEMMA port, highlighted in pink.

Powering the Feather with a Battery

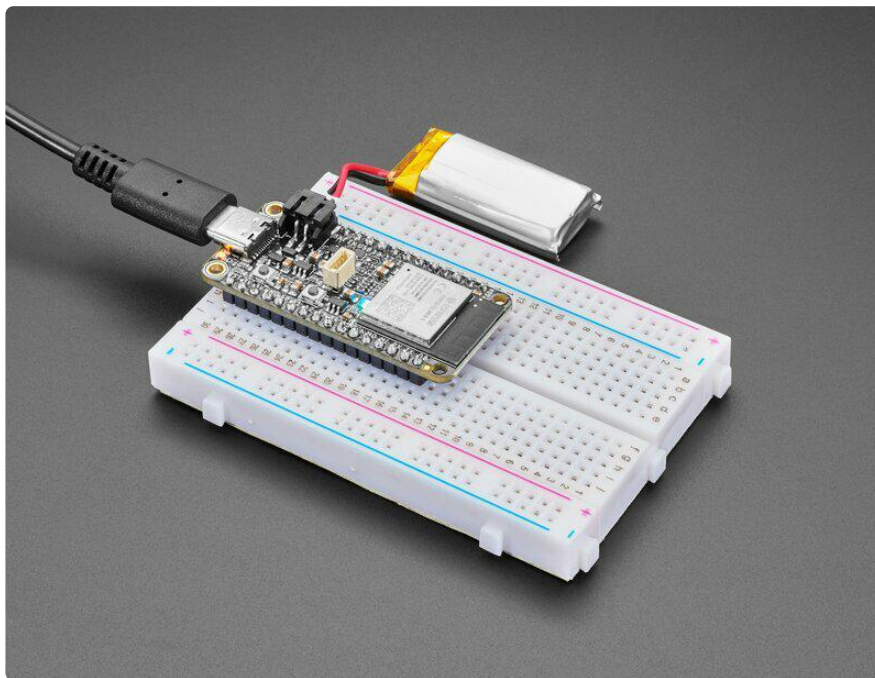

Adafruit highly advises using Adafruit batteries. They have the correct wiring and built in short circuit protection. Batteries from other sources may have incorrect wiring and/or no short protection.

You can plug any 250mAh or larger 3.7/4.2V Lipoly battery into the JST 2-PH port (identified in the diagram below) to power your Feather and charge the battery. The battery will charge from the USB power when USB is plugged in. If the battery is plugged in and USB is plugged in, the Feather will power itself from USB and charge the battery up.

For more information about powering your Feather, visit the [Power Management Page in this guide >>> \(\)](#)

Add Battery Monitor Component to Adafruit IO

From your device page, click the New Component (or +) button.

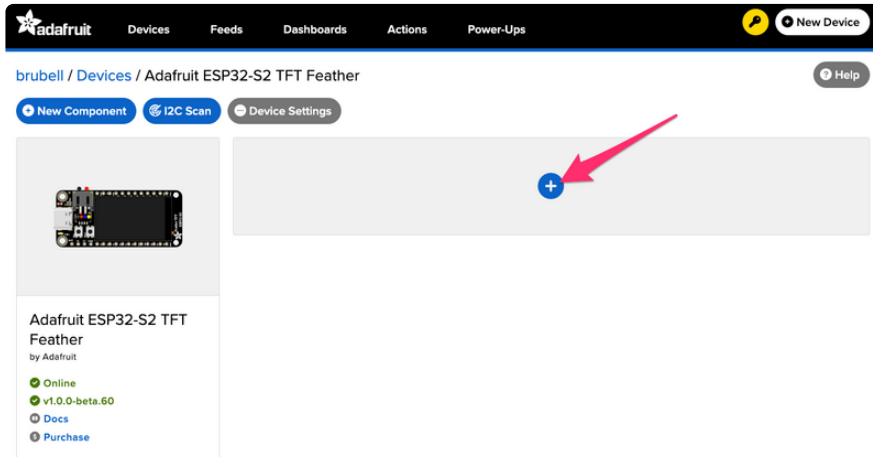

From the component picker, select the MAX17048.

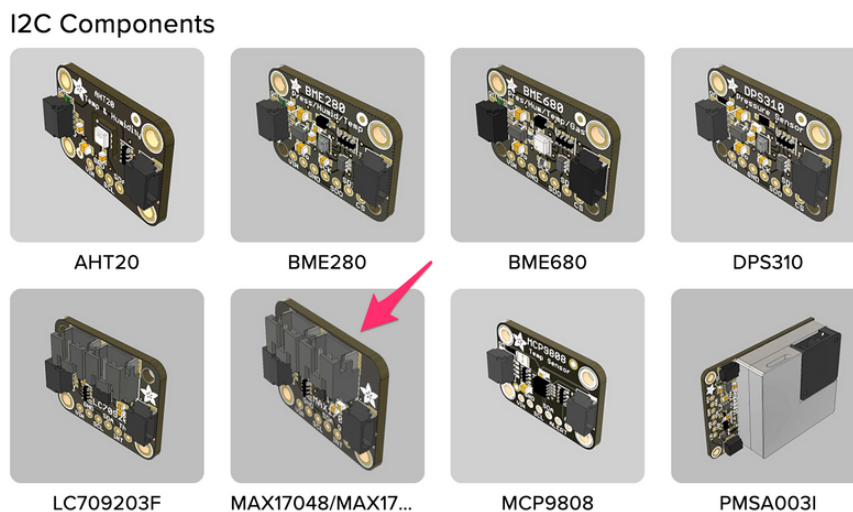

On the Create MAX17048 Component form, there are two options:

1. Enabling the battery cell voltage reading will cause the Feather to report the status of its battery expressed in Volts.
2. Enabling the battery cell percent reading will cause the Feather to report the status of its battery expressed as a percent.

Then, the battery measurement will be read and sent to Adafruit IO every "Send Every" period.

In the screenshot below, we've configured the battery monitor to report its battery cell voltage and percent to Adafruit IO every 30 seconds.

After configuring the MAX17048 component, click Create Component.

Create MAX17048/MAX17049 Component ✕

Select I2C Address:

Enable MAX17048/MAX17049: Battery Cell Voltage?
Name:

Send Every:

Enable MAX17048/MAX17049: Battery Cell Percent?
Name:

Send Every:

[← Back to Component Type](#) Create Component

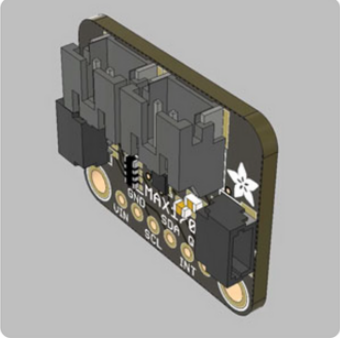

Every 30 seconds, the Feather uses the MAX17048 component to measure its battery cell percent and voltage, and report it back to Adafruit IO.

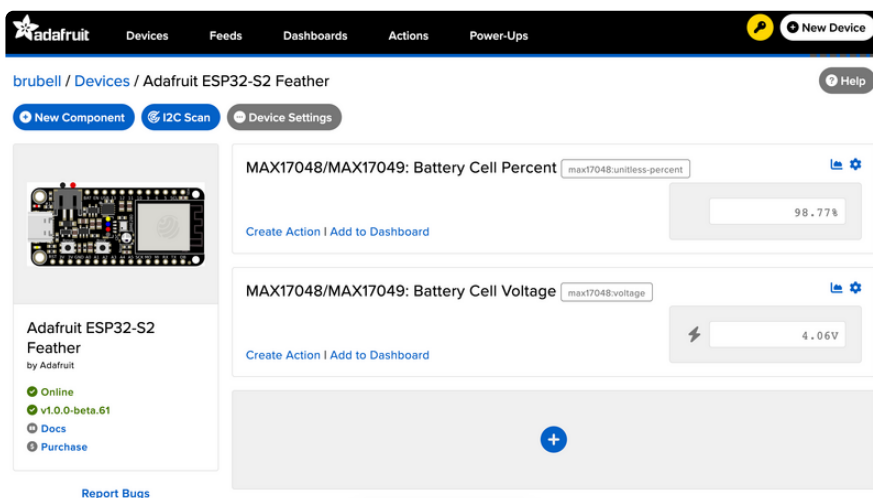

adafruit Devices Feeds Dashboards Actions Power-Ups New Device

brubell / Devices / Adafruit ESP32-S2 Feather Help

[New Component](#) [I2C Scan](#) [Device Settings](#)

Adafruit ESP32-S2 Feather by Adafruit

- Online
- v1.0.0-beta.61
- Docs
- Purchase

[Report Bugs](#)

MAX17048/MAX17049: Battery Cell Percent max17048:unitless-percent 98.77%

MAX17048/MAX17049: Battery Cell Voltage max17048:voltage 4.06V

[+](#)

Going Further

Now that you have a battery monitor component set up on Adafruit IO, [follow this guide to configure Adafruit IO Action for receiving an SMS when your Feather's battery level is below a threshold.](#) ()

Battery Monitor (LC709203F)

As of February 8, 2023, the now-discontinued LC709203 battery monitor chip has been replaced with the MAX17048. Unsure which one you have? Check the silk on the back of the board. If your board does NOT have "MAX17048 Monitor" in the upper left corner, then you have the LC709203 version.

There are two ways to power your Feather:

- 1) Power with a USB Cable connected to a power source.
- 2) Connect a 4.2/3.7V Lithium Polymer (LiPo/LiPoly) or Lithium Ion (Lilon) battery to the JST jack. This lets you run the Feather without wires, untethered!

If you're running off of a battery, chances are you want to know what the voltage is! That way you can tell when the battery needs recharging.

In this section, you'll connect a battery to your Feather, and configure a battery monitor component from Adafruit IO to report the board's battery voltage and charge percentage.

Where is the Battery Monitor on my Feather?

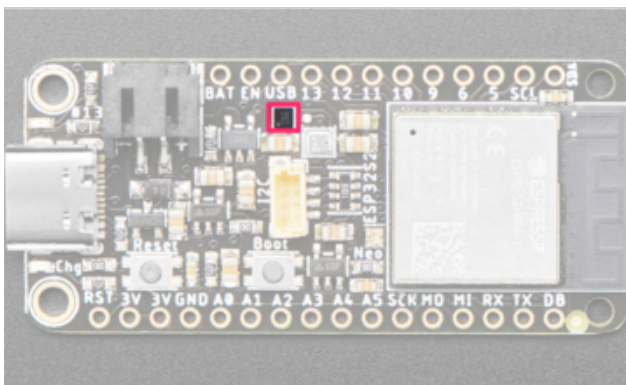

The Feather's LC709203F LiPoly / Lilon Fuel Gauge and Battery Monitor is located directly above the STEMMA port, highlighted in pink.

Powering the Feather with a Battery

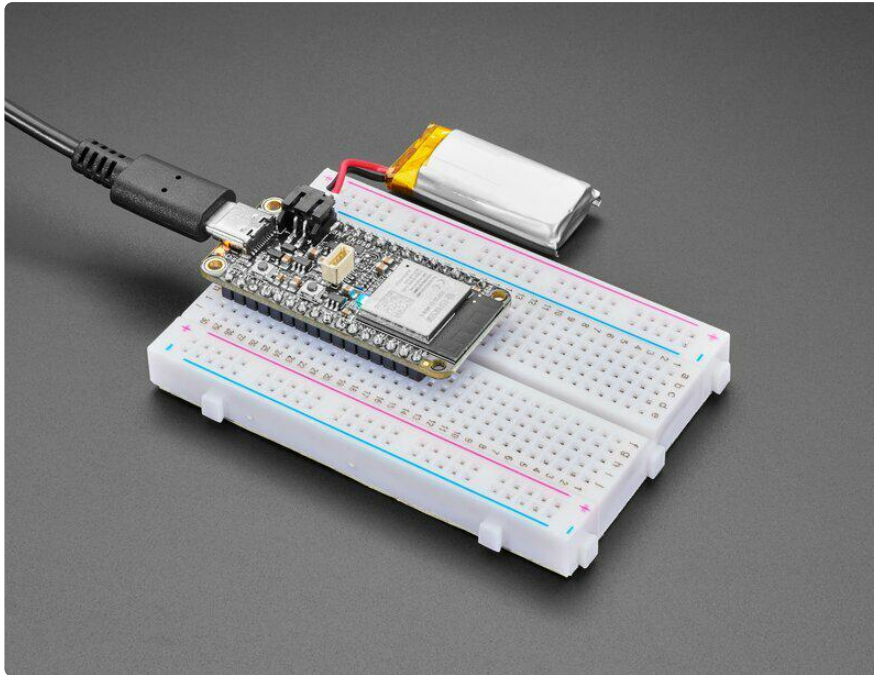

Adafruit highly advises using Adafruit batteries. They have the correct wiring and built in short circuit protection. Batteries from other sources may have incorrect wiring and/or no short protection.

You can plug any 250mAh or larger 3.7/4.2V Lipoly battery into the JST 2-PH port (identified in the diagram below) to power your Feather and charge the battery. The battery will charge from the USB power when USB is plugged in. If the battery is plugged in and USB is plugged in, the Feather will power itself from USB and charge the battery up.

For more information about powering your Feather, visit the [Power Management Page in this guide >>> \(\)](#)

Add Battery Monitor Component to Adafruit IO

From your device page, click the New Component (or +) button.

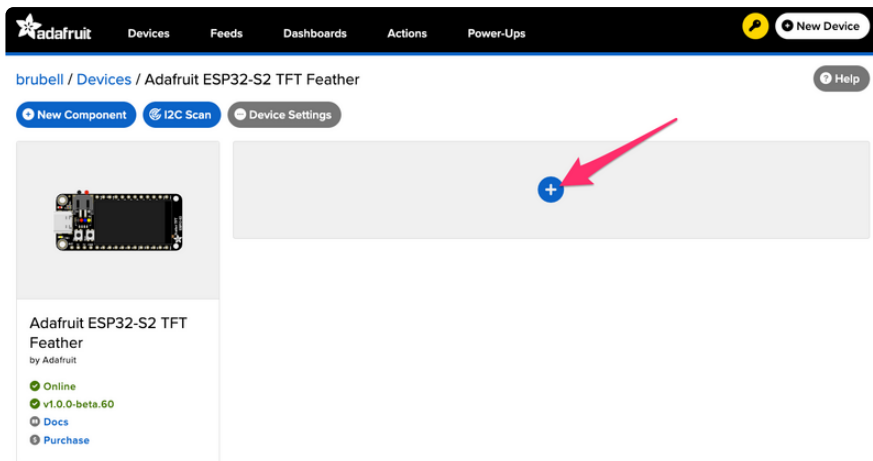

From the component picker, select the LC709203F.

I2C Components

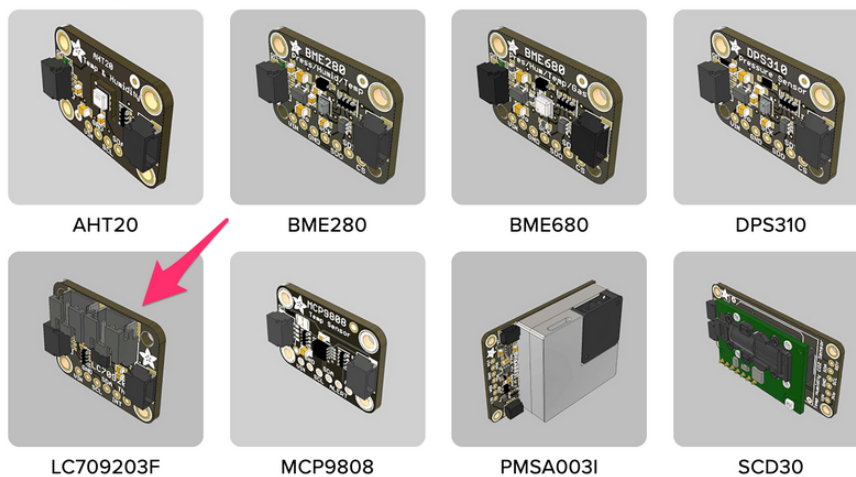

On the Create LC709203F Component form, there are two options:

1. Enabling the battery cell voltage reading will cause the Feather to report the status of its battery expressed in Volts.
2. Enabling the battery cell percent reading will cause the Feather to report the status of its battery expressed as a percent.

Then, the battery measurement will be read and sent to Adafruit IO every "Send Every" period.

In the screenshot below, we've configured the battery monitor to report its battery cell voltage and percent to Adafruit IO every 30 seconds.

After configuring the LC709203F component, click Create Component.

Create LC709203F Component

Select I2C Address:

0xb

Enable LC709203F: Battery Cell Voltage?

Name:

LC709203F: Battery Cell Voltage

Send Every:

Every 30 seconds

Enable LC709203F: Battery Cell Percent?

Name:

LC709203F: Battery Cell Percent

Send Every:

Every 30 seconds

[← Back to Component Type](#)

[Create Component](#)

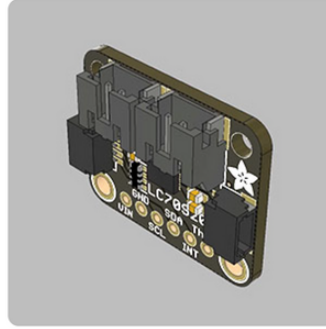

Every 30 seconds, the Feather uses the LC709203F component to measure its battery cell percent and voltage, and report it back to Adafruit IO.

The screenshot shows the Adafruit IO dashboard for a device named 'brubell / Devices / Adafruit ESP32-S2 TFT Feather'. Under the 'Device Settings' tab, two components are listed:

- LC709203F: Battery Cell Percent** (ID: lc709203f:unitless-percent) showing a value of 100.00%.
- LC709203F: Battery Cell Voltage** (ID: lc709203f:voltage) showing a value of 4.18V.

Each component has a 'Create Action | Add to Dashboard' link. The device status is 'Online' with version 'v1.0.0-beta.60'. Navigation options include 'New Component', 'I2C Scan', and 'Device Settings'.

Going Further

Now that you have a battery monitor component set up on Adafruit IO, [follow this guide to configure Adafruit IO Action for receiving an SMS when your Feather's battery level is below a threshold.](#) ()

Factory Reset

The Adafruit ESP32-S2 TFT Feather microcontroller ships running a diagnostic demo with data shown on the display, and a NeoPixel rainbow swirl. It's lovely, but you

probably had other plans for the board. As you start working with your board, you may want to return to the original code to begin again, or you may find your board gets into a bad state. Either way, this page has you covered.

You're probably used to seeing the FTHRS2BOOT drive when loading CircuitPython or Arduino. The FTHRS2BOOT drive is part of the UF2 bootloader, and allows you to drag and drop files, such as CircuitPython. However, on the ESP32-S2 the UF2 bootloader can become damaged.

Factory Reset Firmware UF2

If you have a bootloader still installed - which means you can double-click to get the FTHRS2BOOT drive to appear, then you can simply drag this UF2 file over to the BOOT drive.

To enter bootloader mode, plug in the board into a USB cable with data/sync capability. Press the reset button once, wait till the RGB LED turns purple, then press the reset button again. Then drag this file over:

[Click to download the TFT Feather factory reset UF2](#)

Your board is now back to its factory-shipped state! You can now begin again with your plans for your board.

Factory Reset and Bootloader Repair

What if you tried double-tapping the reset button, and you still can't get into the UF2 bootloader? Whether your board shipped without the UF2 bootloader, or something damaged it, this section has you covered.

There is no bootloader protection for the UF2 bootloader. That means it is possible to erase or damage the UF2 bootloader, especially if you upload an Arduino sketch to an ESP32-S2/S3 board that doesn't "know" there's a bootloader it should not overwrite!

It turns out, however, the ESP32-S2/S3 comes with a second bootloader: the ROM bootloader. Thanks to the ROM bootloader, you don't have to worry about damaging the UF2 bootloader. The ROM bootloader can never be disabled or erased, so its

always there if you need it! You can simply re-load the UF2 bootloader from the ROM bootloader.

Completing a factory reset will erase your board's firmware which is also used for storing CircuitPython/Arduino/Files! Be sure to back up your data first.

There are two ways to do a factory reset and bootloader repair. The first is using WebSerial through a Chromium-based browser, and the second is using `esptool` via command line. We highly recommend using WebSerial through Chrome/Chromium.

The next section walks you through the prerequisite steps needed for both methods.

Download .bin and Enter Bootloader

Step 1. Download the factory-reset-and-bootloader.bin file

Save the following file wherever is convenient for you. You will need to access it from the WebSerial ESPTool.

Note that this file is approximately 3MB. This is not because the bootloader is 3MB, it is because the bootloader is near the end of the available flash. Most of the file is empty but its easier to program if you use a combined file.

[Click to download TFT Feather factory reset and bootloader .bin](#)

Step 2. Enter ROM bootloader mode

Entering the ROM bootloader is easy. Complete the following steps.

Before you start, make sure your ESP32-S2/S3 is plugged into USB port to your computer using a data/sync cable. Charge-only cables will not work!

To enter the bootloader:

1. Press and hold the BOOT/DFU button down. Don't let go of it yet!
2. Press and release the Reset button. You should still have the BOOT/DFU button pressed while you do this.

3. Now you can release the BOOT/DFU button.

No USB drive will appear when you've entered the ROM bootloader. This is normal!

Now that you've downloaded the .bin file and entered the bootloader, you're ready to continue with the factory reset and bootloader repair process. The next two sections walk you through using WebSerial and `esptool`.

The WebSerial ESPTool Method

We highly recommend using WebSerial ESPTool method to perform a factory reset and bootloader repair. However, if you'd rather use esptool via command line, you can skip this section.

This method uses the WebSerial ESPTool through Chrome or a Chromium-based browser. The WebSerial ESPTool was designed to be a web-capable option for programming ESP32-S2/S3 boards. It allows you to erase the contents of the microcontroller and program up to four files at different offsets.

You will have to use a Chromium browser (like Chrome, Opera, Edge...) for this to work, Safari and Firefox, etc. are not supported because we need Web Serial and only Chromium is supporting it to the level needed.

Follow the steps to complete the factory reset.

If you're using Chrome 88 or older, see the Older Versions of Chrome section at the end of this page for instructions on enabling Web Serial.

Connect

You should have plugged in only the ESP32-S2/S3 that you intend to flash. That way there's no confusion in picking the proper port when it's time!



In the Chrome browser visit https://adafruit.github.io/Adafruit_WebSerial_ESPTool/ (). You should see something like the image shown.

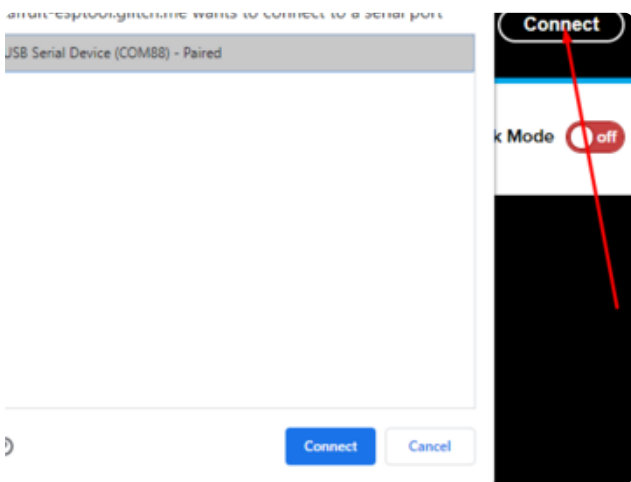

Press the Connect button in the top right of the web browser. You will get a pop up asking you to select the COM or Serial port.

Remember, you should remove all other USB devices so only the ESP32-S2/S3 board is attached, that way there's no confusion over multiple ports!

On some systems, such as MacOS, there may be additional system ports that appear in the list.

```

ESP Web Flasher loaded.
Connecting...
Connected successfully.
Try hard reset.
Chip type ESP32-S2
Connected to ESP32-S2
MAC Address: 7C:DF:A1:06:8D:D0
Uploading stub...
Running stub...
Stub is now running...
Detecting Flash Size
FlashId: 0x164020
Flash Manufacturer: 20
Flash Device: 4016
Auto-detected Flash size: 4MB

```

The JavaScript code will now try to connect to the ROM bootloader. It may timeout for a bit until it succeeds. On success, you will see that it is Connected and will print out a unique MAC address identifying the board along with other information that was detected.

Offset: 0x

Offset: 0x

Offset: 0x

Offset: 0x

```
Adafruit WebSerial ESPTool loaded.
Connecting...
Connected successfully.
Timed out after 100 milliseconds
Timed out after 100 milliseconds
Timed out after 100 milliseconds
Timed out after 100 milliseconds
Timed out after 100 milliseconds
Timed out after 100 milliseconds
Timed out after 100 milliseconds
Timed out after 100 milliseconds
Timed out after 100 milliseconds
Timed out after 100 milliseconds
Changed baud rate to 921600
Connected to ESP32-S2
MAC Address: E6:85:6D:92:AA:32
```

Once you have successfully connected, the command toolbar will appear.

Erase the Contents

This will erase everything on your board! If you have access, and wish to keep any code, now is the time to ensure you've backed up everything.



To erase the contents, click the Erase button. You will be prompted whether you want to continue. Click OK to continue or if you changed your mind, just click cancel.

```
Erasing flash memory. Please wait...
Finished. Took 15899ms to erase.
```

You'll see "Erasing flash memory. Please wait..." This will eventually be followed by "Finished." and the amount of time it took to erase.

Do not disconnect! Immediately continue on to programming the ESP32-S2/S3.

Do not disconnect after erasing! Immediately continue on to the next step!

Program the ESP32-S2/S3

Programming the microcontroller can be done with up to four files at different locations, but with the board-specific factory-reset.bin file, which you should have downloaded under Step 1 on this page, you only need to use one file.

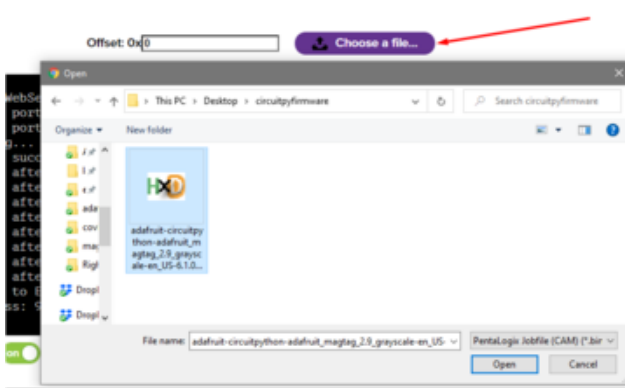

Click on the first Choose a file.... (The tool will only attempt to program buttons with a file and a unique location.) Then, select the *-factory-reset.bin file you downloaded in Step 1 that matches your board.

Verify that the Offset box next to the file location you used is (0x) 0.

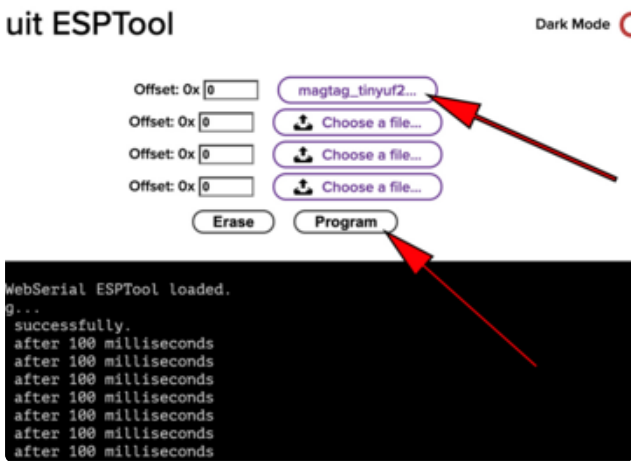

Once you choose a file, the button text will change to match your filename. You can then select the Program button to begin flashing.

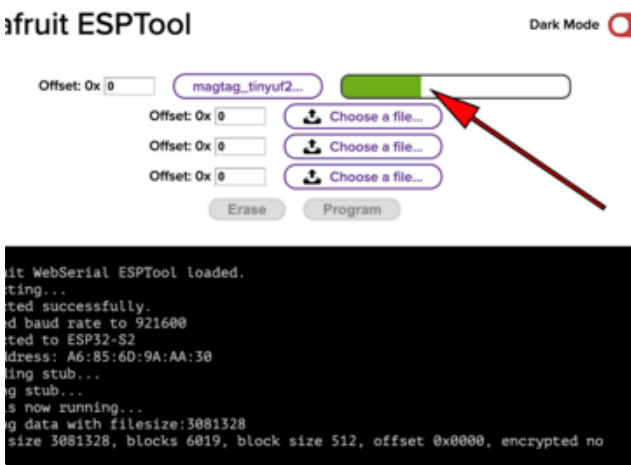

A progress bar will appear and after a minute or two, you will have written the firmware.

Once completed, you can skip down to the section titled Reset the Board.

The `esptool` Method (for advanced users)

If you used WebSerial ESPTool, you do not need to complete the steps in this section!

Once you have entered ROM bootloader mode, you can then [use Espressif's esptool program \(\)](#) to communicate with the chip! `esptool` is the 'official' programming tool and is the most common/complete way to program an ESP chip.

Install ESPTool.py

You will need to use the command line / Terminal to install and run `esptool`.

You will also need to have pip and Python installed (any version!).

Install the latest version using pip (you may be able to run `pip` without the `3` depending on your setup):

```
pip3 install --upgrade esptool
```

Then, you can run:

```
esptool.py
```

Make sure you are running esptool v3.0 or higher, which adds ESP32-S2/S3 support.

Test the Installation

Run `esptool.py` in a new terminal/command line and verify you get something like the below:

```
C:\Users\ladyada>python3 C:\ESP32\esp-idf\components\esptool_py\esptool\esptool.py
esptool.py v3.0-dev
usage: esptool [-h] [--chip {auto,esp8266,esp32,esp32s2}] [--port PORT] [--baud BAUD]
              [--before {default_reset,no_reset,no_reset_no_sync}]
              [--after {hard_reset,soft_reset,no_reset}] [--no-stub] [--trace]
              [--override-vddsdio [{1.8V,1.9V,OFF}]] [--connect-attempts CONNECT_ATTEMPTS]
              {load_ram,dump_mem,read_mem,write_mem,write_flash,run,image_info,make_image,elf2image,read
_mac,chip_id,flash_id,read_flash_status,write_flash_status,read_flash,verify_flash,erase_flash,erase_regi
on,version,get_security_info}
              ...
```

Connect

Run the following command, replacing the identifier after `--port` with the `COMxx`, `/dev/cu.usbmodemxx` or `/dev/ttySxx` you found above.

```
esptool.py --port COM88 chip_id
```

You should get a notice that it connected over that port and found an ESP32-S2/S3.

```
C:\Users\ladyada>python3 C:\ESP32\esp-idf\components\esptool_py\esptool\esptool.py --port COM88 chip_id
esptool.py v3.0-dev
Serial port COM88
Connecting...
Detecting chip type... ESP32-S2
Chip is ESP32-S2
Features: WiFi, ADC and temperature sensor calibration in BLK2 of efuse
Crystal is 40MHz
MAC: 7c:df:a1:00:3f:3e
Uploading stub...
Running stub...
Stub running...
Warning: ESP32-S2 has no Chip ID. Reading MAC instead.
MAC: 7c:df:a1:00:3f:3e
Hard resetting via RTS pin...
ERROR: ESP32-S2 chip was placed into download mode using GPIO0.
esptool.py can not exit the download mode over USB. To run the app, reset the chip manually.
To suppress this error, set --after option to 'no_reset'.
```

Installing the Bootloader

Run this command and replace the serial port name with your matching port and the file you just downloaded

```
esptool.py --port COM88 write_flash 0x0 tinyuf2_combo.bin
```

Don't forget to change the `--port` name to match.

There might be a bit of a 'wait' when programming, where it doesn't seem like it's working. Give it a minute, it has to erase the old flash code which can cause it to seem like it's not running.

You'll finally get an output like this:

```
esptool.py v3.0-dev
Serial port COM88
Connecting...
Detecting chip type... ESP32-S2
Chip is ESP32-S2
Features: WiFi, ADC and temperature sensor calibration in BLK2 of efuse
Crystal is 40MHz
MAC: 7c:df:a1:05:f8:9a
Uploading stub...
Running stub...
Stub running...
Configuring flash size...
Auto-detected Flash size: 4MB
Compressed 3081264 bytes to 98937...
Wrote 3081264 bytes (98937 compressed) at 0x00000000 in 22.8 seconds (effective 1080.0 kbit/s)...
Hash of data verified.
Leaving...
Hard resetting via RTS pin...
ERROR: ESP32-S2 chip was placed into download mode using GPIO0.
esptool.py can not exit the download mode over USB. To run the app, reset the chip manually.
To suppress this error, set --after option to 'no_reset'.
```

Once completed, you can continue to the next section.

Reset the board

Now that you've reprogrammed the board, you need to reset it to continue. Click the reset button to launch the new firmware.

The display will show colored text including the battery status and I2C port scan results, and the NeoPixel will light up in a rainbow swirl.

You've successfully returned your board to a factory reset state!

Older Versions of Chrome

As of chrome 89, Web Serial is already enabled, so this step is only necessary on older browsers.

We suggest updating to Chrome 89 or newer, as Web Serial is enabled by default.

If you must continue using an older version of Chrome, follow these steps to enable Web Serial.

Sorry, **Web Serial** is not supported on this device, make sure you're running Chrome 78 or later and have enabled the `#enable-experimental-web-platform-features` flag in `chrome://flags`

If you receive an error like the one shown when you visit the WebSerial ESPTool site, you're likely running an older version of Chrome.

You must be using Chrome 78 or later to use Web Serial.

WARNING: EXPERIMENTAL FEATURES AHEAD! By enabling these features, you could lose browser data or compromise your security or privacy. Enabled features apply to all users of this browser.

Interested in cool new Chrome features? Try our [beta channel](#).

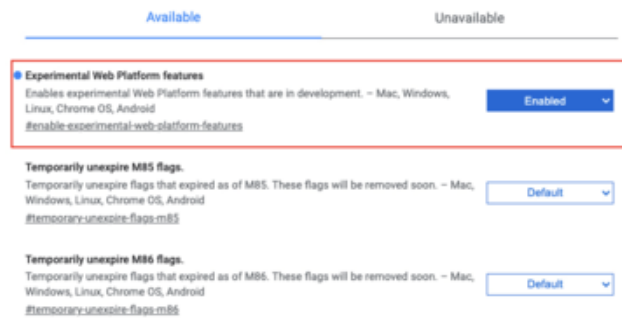

To enable Web Serial in Chrome versions 78 through 88:

Visit `chrome://flags` from within Chrome. Find and enable the Experimental Web Platform features
Restart Chrome

The Flash an Arduino Sketch Method

This section outlines flashing an Arduino sketch onto your ESP32-S2/S3 board, which automatically installs the UF2 bootloader as well.

Arduino IDE Setup

If you don't already have the Arduino IDE installed, the first thing you will need to do is to download the latest release of the Arduino IDE. ESP32-S2/S3 requires version 1.8 or higher. Click the link to download the latest.

[Arduino IDE Download](#)

After you have downloaded and installed the latest version of Arduino IDE, you will need to start the IDE and navigate to the Preferences menu. You can access it from the File > Preferences menu in Windows or Linux, or the Arduino > Preferences menu on OS X.

The Preferences window will open.

In the Additional Boards Manager URLs field, you'll want to add a new URL. The list of URLs is comma separated, and you will only have to add each URL once. The URLs point to index files that the Board Manager uses to build the list of available & installed boards.

Copy the following URL.

https://raw.githubusercontent.com/espressif/arduino-esp32/gh-pages/package_esp32_dev_index.json

Add the URL to the the Additional Boards Manager URLs field (highlighted in red below).

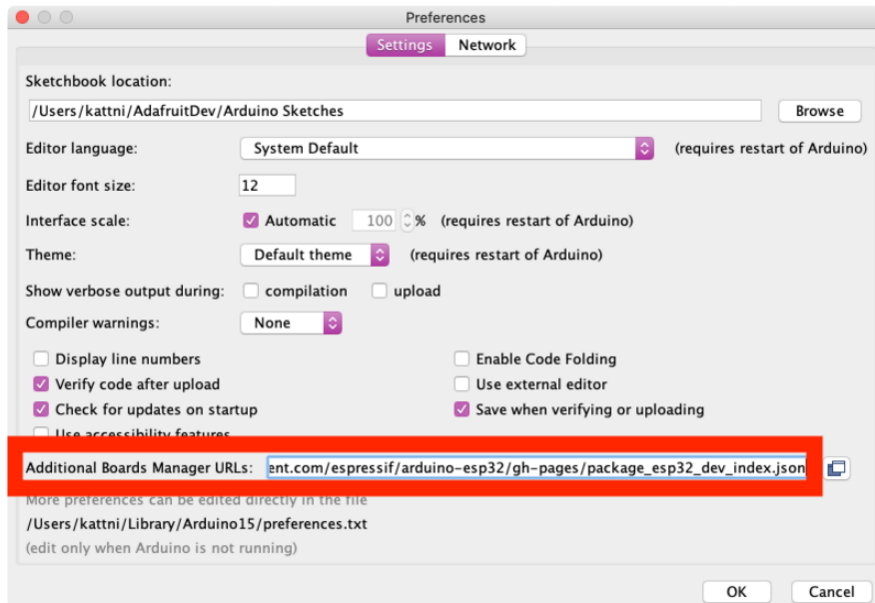

Click OK to save and close Preferences.

In the Tools > Boards menu you should see the ESP32 Arduino menu. In the expanded menu, it should contain the ESP32 boards along with all the latest ESP32-S2 boards.

Now that your IDE is setup, you can continue on to loading the sketch.

Load the Blink Sketch

In the Tools > Boards menu you should see the ESP32 Arduino menu. In the expanded menu, look for the menu option for the Adafruit Feather ESP32-S2 TFT, and click on it to choose it.

Open the Blink sketch by clicking through File > Examples > 01.Basics > Blink.

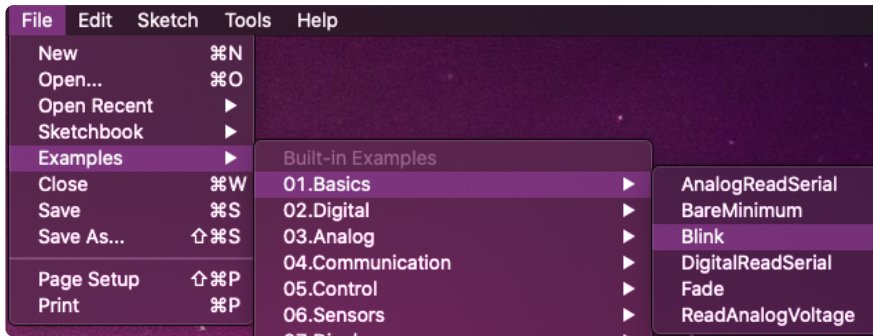

Once open, click Upload from the sketch window.

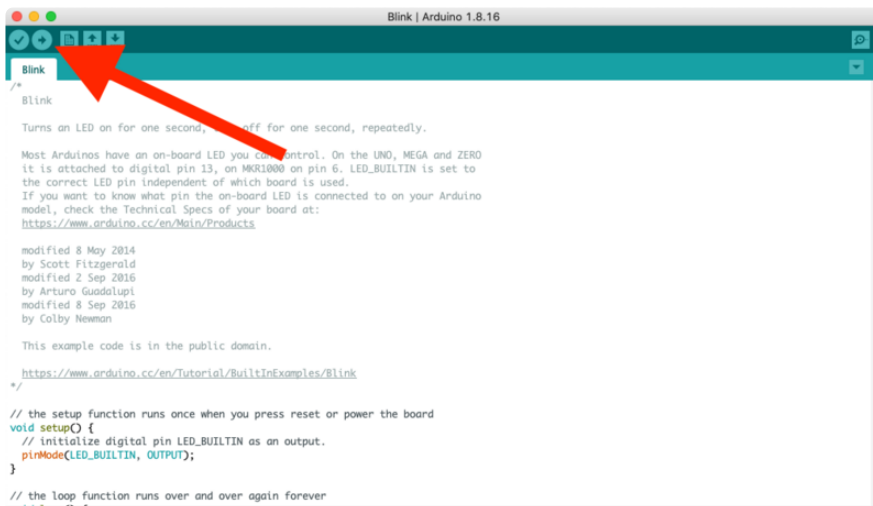

Once successfully uploaded, the little red LED will begin blinking once every second. At that point, you can now enter the bootloader.

Install UF2 Bootloader

If your board has a UF2 bootloader, you do not need to follow the steps on this page. Try to enter the UF2 bootloader before continuing! Double-tap the reset button to do so.

The Adafruit ESP32-S2 Feather TFT ships with a UF2 bootloader which allows the board to show up as FTTHRS2BOOT when you double-tap the reset button, and enables you to drag and drop UF2 files to update the firmware.

On ESP32-S2/S3, there is no bootloader protection for the UF2 bootloader. That means it is possible to erase or damage the UF2 bootloader, especially if you upload an Arduino sketch to an ESP32-S2/S3 board that doesn't "know" there's a bootloader it should not overwrite!

It turns out, however, the ESP32-S2/S3 comes with a second bootloader: the ROM bootloader. Thanks to the ROM bootloader, you don't have to worry about damaging the UF2 bootloader. The ROM bootloader can never be disabled or erased, so its always there if you need it! You can simply re-load the UF2 bootloader from the ROM bootloader.

If your UF2 bootloader ends up damaged or overwritten, you can follow the steps found in the [Factory Reset and Bootloader Repair \(\)](#) section of the Factory Reset page in this guide.

Once completed, you'll return to where the board was when you opened the package. Then you'll be back in business, and able to continue with your existing plans!

Downloads

Files

- [ESP32-S2 product page with resources \(\)](#)
- [ESP32-S2 datasheet \(\)](#)
- [ESP32-S2 Technical Reference \(\)](#)
- [EagleCAD PCB files on GitHub \(\)](#)
- [3D Models on GitHub \(\)](#)
- [Fritzing object in the Adafruit Fritzing Library \(\)](#)
- [PrettyPins PDF on GitHub \(\)](#)
- [PrettyPins SVG \(\)](#)

Factory test source code

Schematic and Fab Print

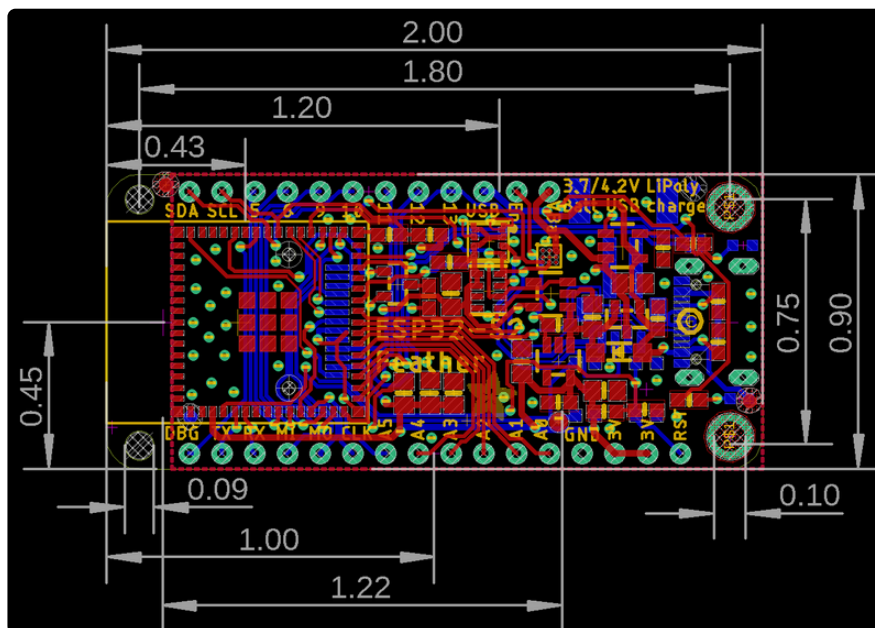
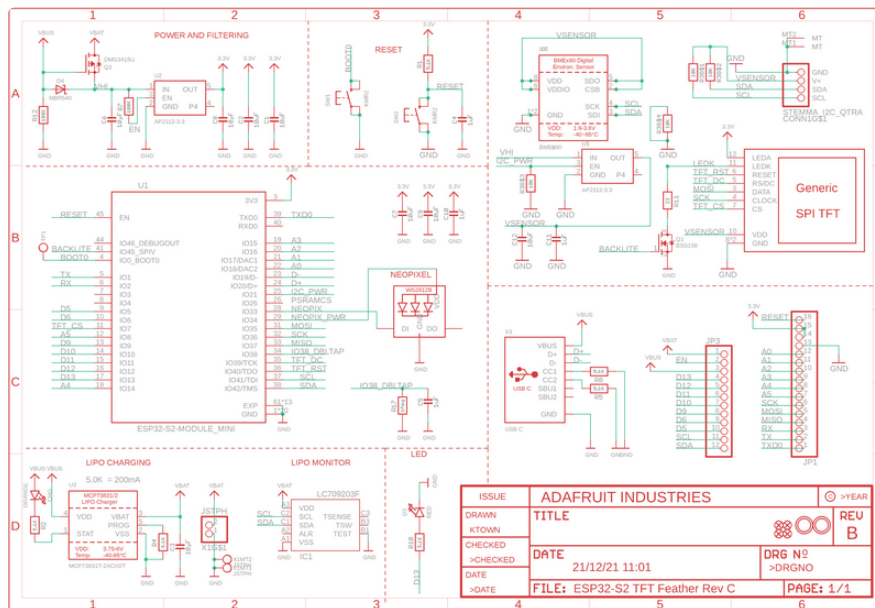

3D Model

