

SUMMARY

Wires

Low voltage 10



Image is for illustrative purpose only

Series 2F
Termination type Female crimp
IP rating 67
AWG wire size 24.00 - 20.00
Cable Ø 5.30 - 14.00 mm
Status active
Matching parts [EGS.2F.310.XLC](#)

Download

[Request a quote](#)

[Catalog](#)

TECHNICAL DETAILS

Mechanics

Shell Style/Model FG*: Straight plug
Keying 3 keys (beta=155, gamma=50, plug: female contacts, receptacle: male contacts)
Housing Material Aluminium (nickel plated [SAE AMS QQ N 290], anthracite color) shell and nut, other pieces bronze/brass
Weight 12.47 g

Performance

Configuration 2F.310 : 10 Low Voltage
Insulator L: PEEK (UL 94 / V-0/1.5)
Rated Current 8 Amps

Specifications

Contact Type: Crimp
Contact Retention: 30 N
Contact Dia.: 0.9 mm (0.035in)
Bucket Dia.: 1.1 mm (0.043in)
Min. Conductor: 0.25 mm² (AWG 24)
Max. Conductor: 0.5 mm² (AWG 20)
R (max): 4.8 mOhm
Vtest (contact-shell): 2100 V (AC), 2970 V (DC)

LEMO products and services are provided "as is". LEMO makes no warranties or representations with regard to LEMO product & services or use of them, express, implied or statutory, including for accuracy, completeness, or security. The user is fully responsible for his products and applications using LEMO components.

Vtest (contact-contact): 1800 V (AC), 2550 V (DC)

Others

Endurance (Shell): 1000 mating cycles
Temp (min / max): -15°C / +200°C
Humidity (max): <=95% [at 60 deg C / 140 F]
Vibration: 15 g [10 Hz - 2000 Hz]
Shock Resistance: 100 g [6 ms]
Climatical Category: 15/200/21 (Aluminium shell)
Salt Spray Corrosion: max. 48 hr

DRAWINGS

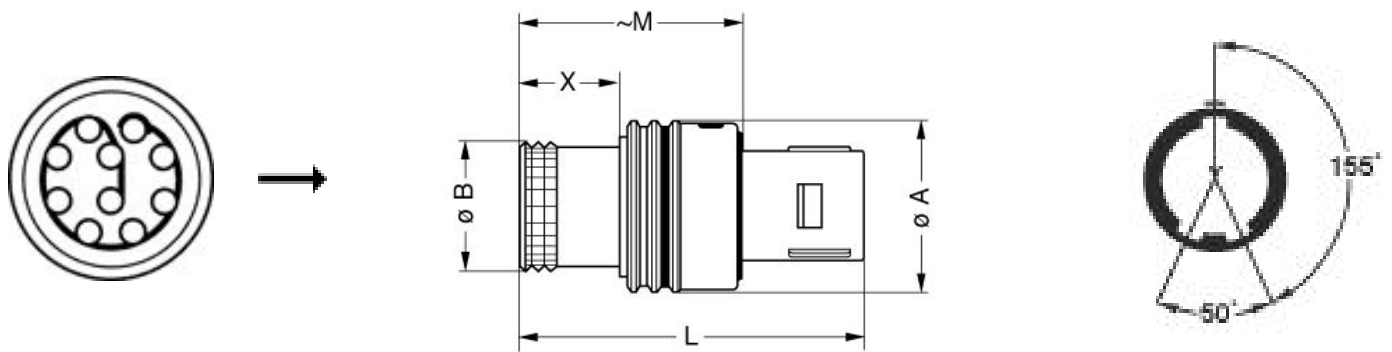

Dimensions

	A	B	L	M	X
mm.	17	14	27.8	17.9	8
in.	0,67	0,55	1,09	0,70	0,31

RECOMMENDED BY LEMO

Tools









Crimp Tool: [DPC.91.701.V](#)

Crimp settings: AWG/Selector = 20-22-24/6-5-5

LEMO products and services are provided "as is". LEMO makes no warranties or representations with regard to LEMO product & services or use of them, express, implied or statutory, including for accuracy, completeness, or security. The user is fully responsible for his products and applications using LEMO components.

Positionner: [DCE.91.090.BVM](#)
 Extractor: [DCC.09.05B.LAG](#)
 Replacement contact: EGG.0B.660.ZZM

Cables

CMN.10.T20.080PGZE		Grey	
CMN.10.T20.080PNZE			
CMN.10.T20.080QGC	TPR	Grey	
CMN.10.T22.068QGZE	TPR (medical)	Grey	
CMN.10.T28.053QGZE	TPR (medical)	Grey	
110220	PVC	Black	
110240	PTFE	White	
110280	PVC	Black	
210140	PVC	Grey	
210240	PVC	Black	
210250	PVC	Grey	
210260	PVC	Black	

LEMO products and services are provided "as is". LEMO makes no warranties or representations with regard to LEMO product & services or use of them, express, implied or statutory, including for accuracy, completeness, or security. The user is fully responsible for his products and applications using LEMO components.