

C4BTDBX5100ZAF J

C4BT, Film, Metallized Polypropylene, Power, 10 uF, 5%, 250 VDC, 70°C, Lead Spacing = 25.5mm

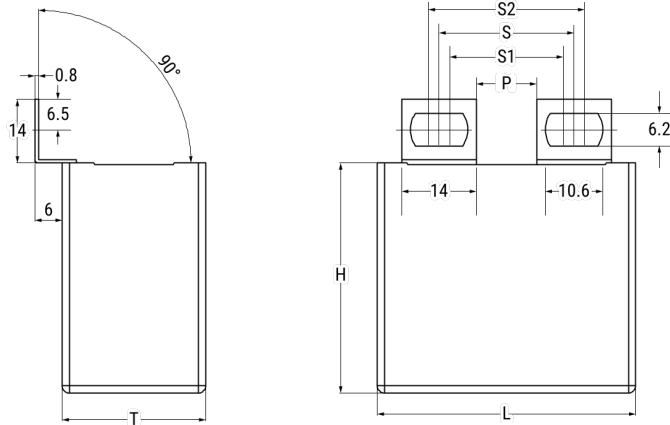

Click [here](#) for the 3D model.

Dimensions	
L	41.5mm +1.5/-0.7mm
H	40mm +0.2/-0.7mm
T	20mm +0.4/-0.7mm
S	25.5mm +/-0.2mm
S1	21.5mm +/-0.2mm
S2	29.5mm +/-0.2mm
P	10.5mm NOM

Packaging Specifications	
Packaging	Bulk, Bag
Packaging Quantity	52

General Information	
Series	C4BT
Dielectric	Metallized Polypropylene
Style	Radial
Features	Switching
RoHS	Yes
Lead	Flat Tabs
AEC-Q200	No
Miscellaneous	KEMET Style A Tabs. Peak Voltage = 600 VDC.

Specifications	
Capacitance	10 uF
Capacitance Tolerance	5%
Voltage DC	250 VDC
Temperature Range	-40/+85°C
Rated Temperature	70°C
Max dV/dt	40 V/us
Resistance	2.6 mOhms (100kHz)
Ripple Current	27 Amps (100kHz 70C), 402 Amps (Peak)
Inductance	41 nH

Statements of suitability for certain applications are based on our knowledge of typical operating conditions for such applications, but are not intended to constitute - and we specifically disclaim - any warranty concerning suitability for a specific customer application or use. This Information is intended for use only by customers who have the requisite experience and capability to determine the correct products for their application. Any technical advice inferred from this Information or otherwise provided by us with reference to the use of our products is given gratis, and we assume no obligation or liability for the advice given or results obtained.