



LED Display Product Data Sheet LTC-2723JD

Spec No.: DS30-2001-233

Effective Date: 02/21/2002

Revision: -

LITE-ON DCC

RELEASE

BNS-OD-FC001/A4

FEATURES

- * 0.28 inch (7.0 mm) DIGIT HEIGHT.
- * CONTINUOUS UNIFORM SEGMENTS.
- * LOW POWER REQUIREMENT.
- * EXCELLENT CHARACTERS APPEARANCE.
- * HIGH BRIGHTNESS & HIGH CONTRAST.
- * WIDE VIEWING ANGLE.
- * SOLID STATE RELIABILITY.
- * CATEGORIZED FOR LUMINOUS INTENSITY.

DESCRIPTION

The LTC-2723JD is a 0.28 inch (7.0 mm) digit height quadruple digit seven-segment display. This device utilizes AlInGaP hi.-eff. red LED chips, which are made from AlInGaP on a non-transparent GaAs substrate, and has a gray face and white segments.

DEVICE

PART NO.	DESCRIPTION
AlInGaP HI.-EFF. RED	Multiplex Common Cathode Rt. Hand Decimal
LTC-2723JD	

PACKAGE DIMENSIONS

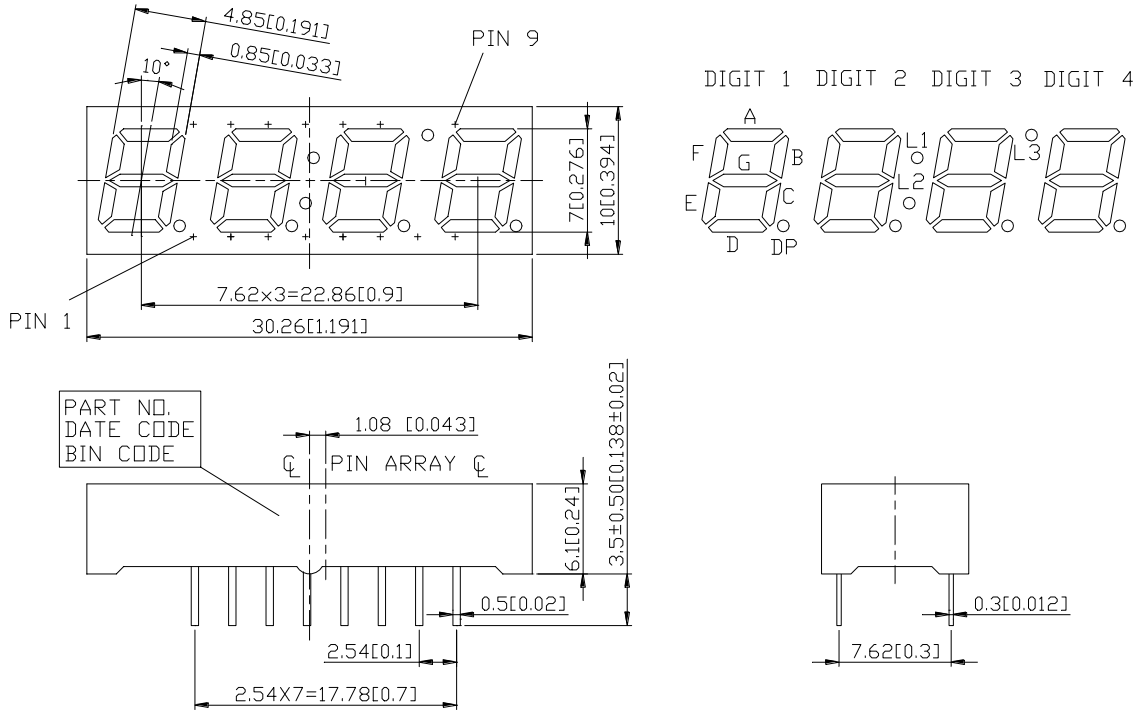

NOTES: All dimensions are in millimeters. Tolerances are ± 0.25-mm (0.01“) unless otherwise noted.

INTERNAL CIRCUIT DIAGRAM

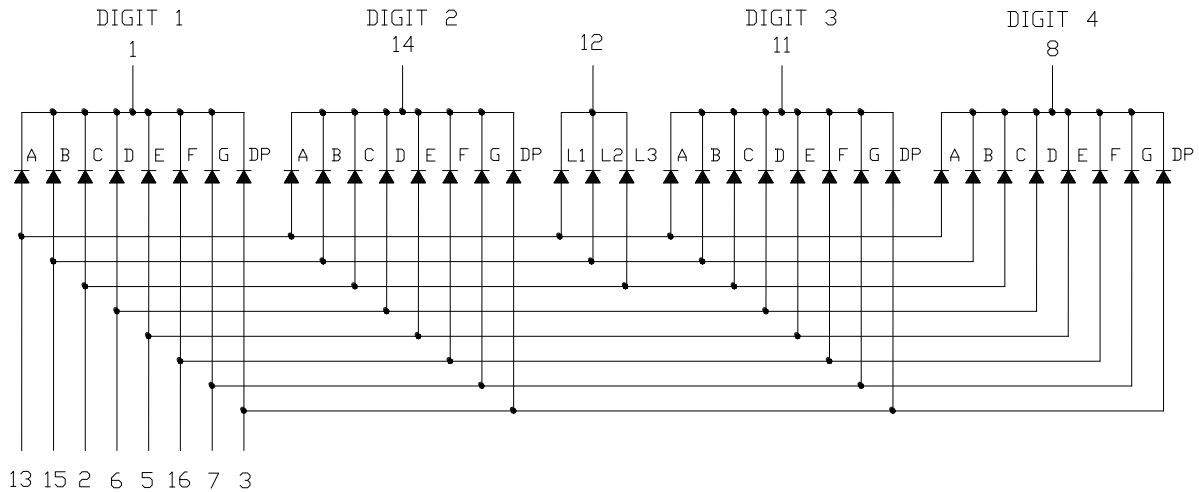

PIN CONNECTION

NO	CONNECTION
1	COMMON CATHODE (DIGIT 1)
2	ANODE C, L3
3	ANODE D.P.
4	NO CONNECTION
5	ANODE E
6	ANODE D
7	ANODE G
8	COMMON CATHODE (DIGIT 4)
9	NO CONNECTION
10	NO PIN
11	COMMON CATHODE (DIGIT 3)
12	COMMON CATHODE L1, L2, L3
13	ANODE A, L1
14	COMMON CATHODE (DIGIT 2)
15	ANODE B, L2
16	ANODE F

ABSOLUTE MAXIMUM RATING AT T_A=25°C

PARAMETER	MAXIMUM RATING	UNIT
Power Dissipation Per Segment	70	mW
Peak Forward Current Per Segment (1/10 Duty Cycle, 0.1ms Pulse Width)	100	mA
Continuous Forward Current Per Segment Derating Linear From 25°C Per Segment	25 0.33	mA mA/°C
Reverse Voltage Per Segment	5	V
Operating Temperature Range	-35°C to +85°C	
Storage Temperature Range	-35°C to +85°C	
Solder Temperature 1/16 inch Below Seating Plane for 3 Seconds at 260°C		

ELECTRICAL / OPTICAL CHARACTERISTICS AT T_A=25°C

PARAMETER	SYMBOL	MIN.	TYP.	MAX.	UNIT	TEST CONDITION
Average Luminous Intensity	I _v	200	600		μcd	I _F =1mA
Peak Emission Wavelength	λ _p		656		nm	I _F =20mA
Spectral Line Half-Width	Δλ		22		nm	I _F =20mA
Dominant Wavelength	λ _d		640		nm	I _F =20mA
Forward Voltage Per Segment	V _F		2.1	2.6	V	I _F =20mA
Reverse Current Per Segment	I _R			10	μA	V _R =5V
Luminous Intensity Matching Ratio	I _v -m			2:1		I _F =10mA

Note: Luminous intensity is measured with a light sensor and filter combination that approximates the CIE (Commision Internationale De L'Eclairage) eye-response curve.

TYPICAL ELECTRICAL / OPTICAL CHARACTERISTIC CURVES

(25°C Ambient Temperature Unless Otherwise Noted)

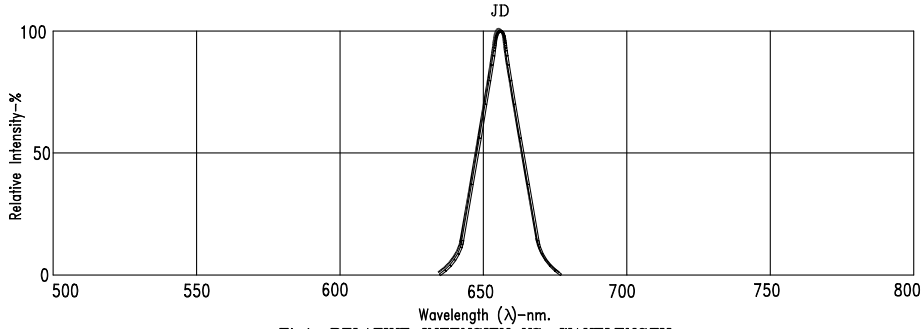

Fig1. RELATIVE INTENSITY VS. WAVELENGTH

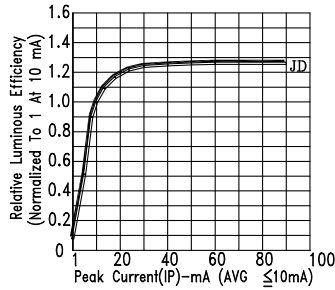

Fig2. RELATIVE LUMINOUS EFFICIENCY (LUMINOUS INTENSITY PER UNIT CURRENT) VS. PEAK CURRENT

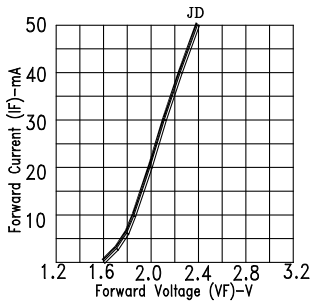

Fig3. FORWARD CURRENT VS. FORWARD VOLTAGE

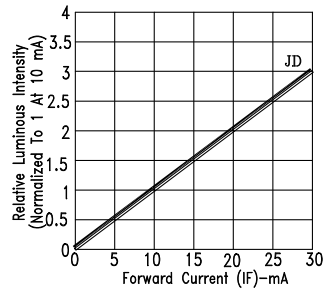

Fig4. RELATIVE LUMINOUS INTENSITY VS. FORWARD CURRENT

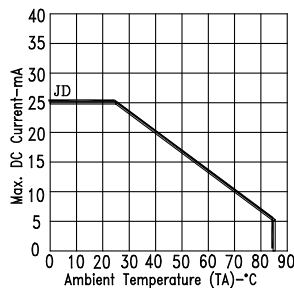

Fig5. MAX. ALLOWABLE DC CURRENT VS. AMBIENT TEMPERATURE.

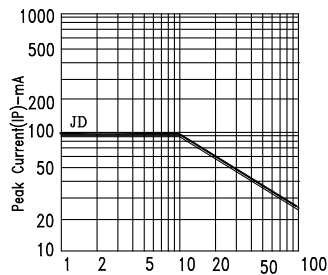

Fig6. MAX. PEAK CURRENT VS. DUTY CYCLE % (REFRESH RATE 1KHz)

NOTE : JD=AlInGaP HI.-EFF. RED