

NCP4306 Synchronous Rectification Evaluation Board User's Manual



ON Semiconductor®

www.onsemi.com

Description

This evaluation board user's manual describes a high efficiency synchronous rectification evaluation board that can easily replace a secondary side rectification diode in an SMPS.

The NCP4306 is used as synchronous rectification controller. The evaluation board has very few external components and illustrates how small and effective such a design can be.

The NCP4306 features a very precise 0 mV turn-off comparator that supports even very low current flowing through the MOSFET even when very low RDSON synchronous MOSFETs is used. NCP4306 can be used in application working in CCM without external synchronization thanks to very low propagation delay and strong driver.

Key Features

- Precise Turn-off Comparator
- Wide Input Voltage Range
- High Operation Frequency
- Strong MOSFET Driver
- High Efficiency
- Adjustable Minimum On and Off Times
- Adjustable Light Load Detection Feature
- Capable to Operate in Positive and Negative Branch
- Small Size

EVAl BOARD USER'S MANUAL

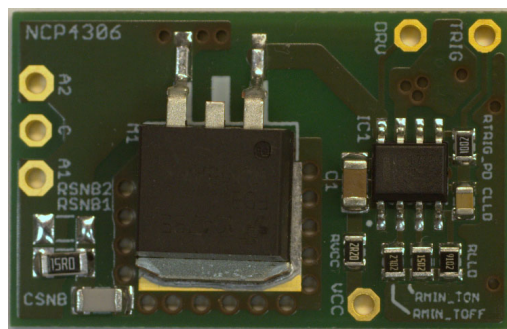

CONNECTION DIAGRAM

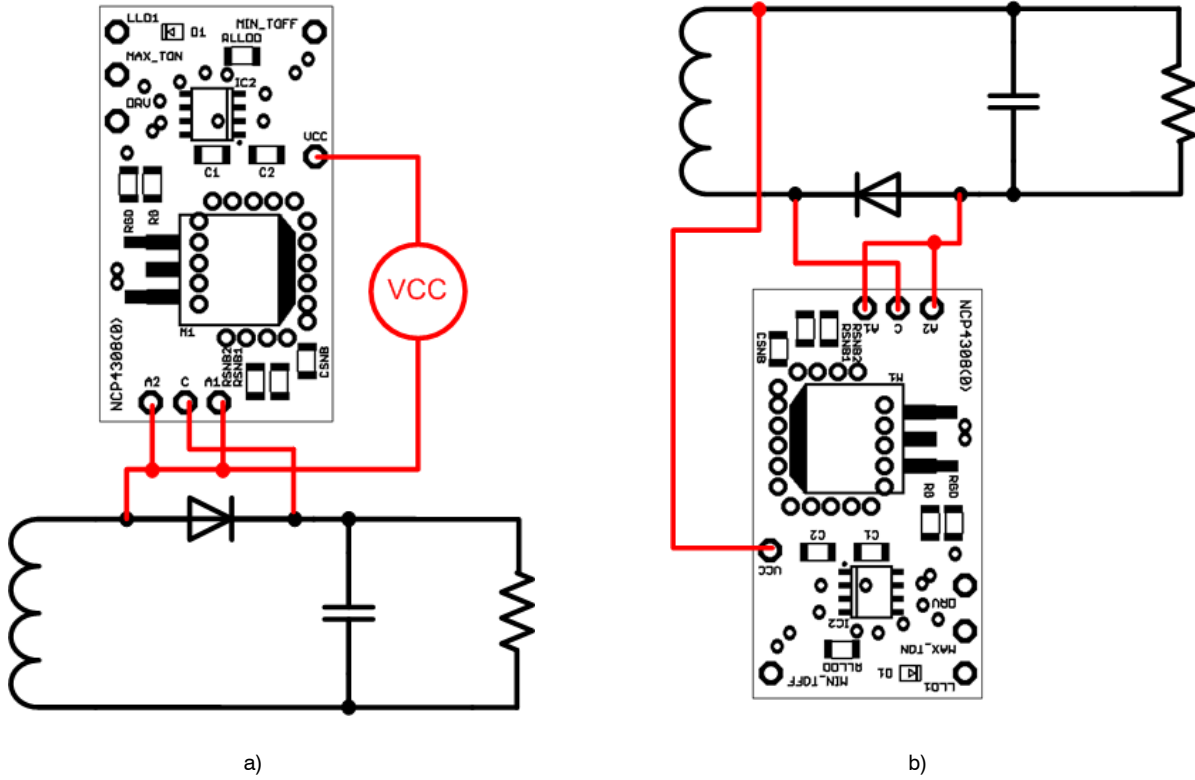

Figure 2. Possible Connections into Circuit

The evaluation board can be connected in circuit where the rectification diode is in the positive or negative branch. When connection to a positive branch is used, it is necessary

to use an external power supply (or auxiliary winding with rectification) to provide power to the evaluation board. VCC should be referenced to A1 or A2 points.

CIRCUIT LAYOUT

The PCB consists of a 2 layer FR4 board with 35 μm copper cladding. All components are surface mount. Critical component such as blocking capacitor C1 has to be placed carefully near the IC. The synchronous driver path to the MOSFET was done with very low resistance and parasitic inductance to minimize emissions and minimize turn-on

and turn-off times. The same is true for the CS pin. For the CS pin, a kelvin contact was done to be able to sense the voltage directly at the drain. Improper connection of the GND and CS connects can impact the turn-off process especially when a very low $R_{\text{DS(on)}}$ MOSFET is used.

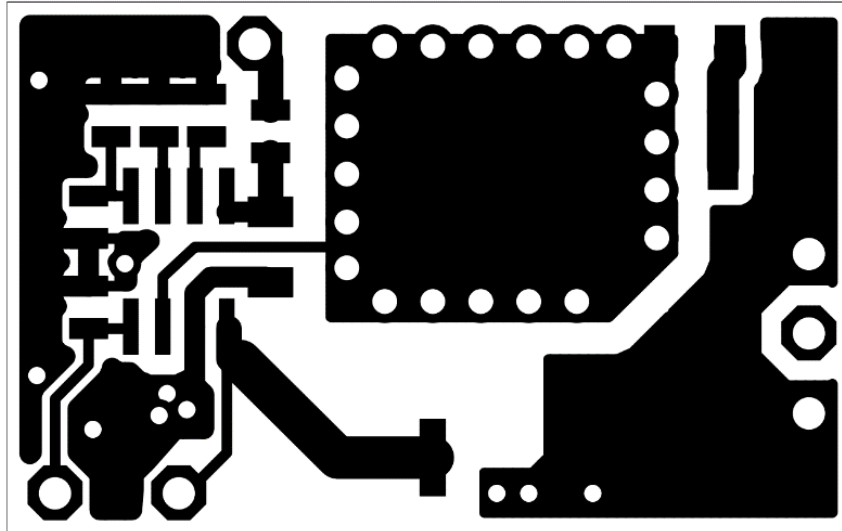

Figure 4. Top Layer

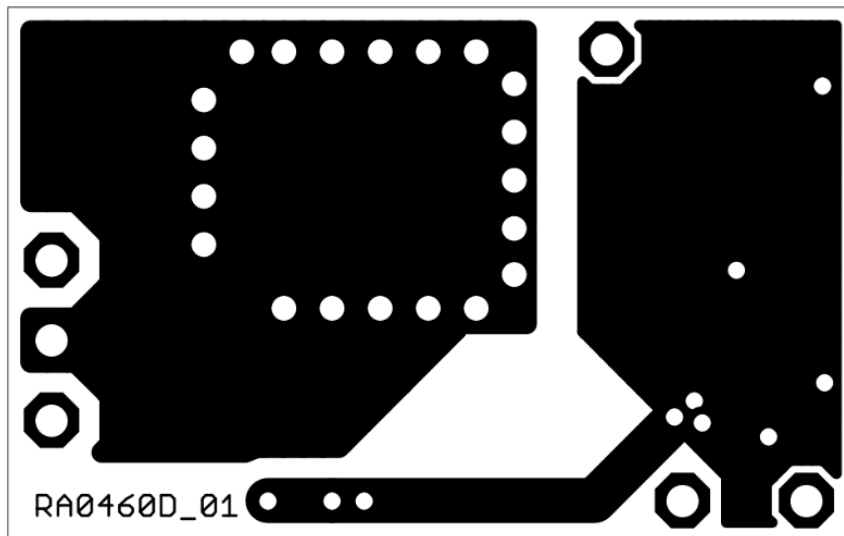

Figure 5. Bottom Layer

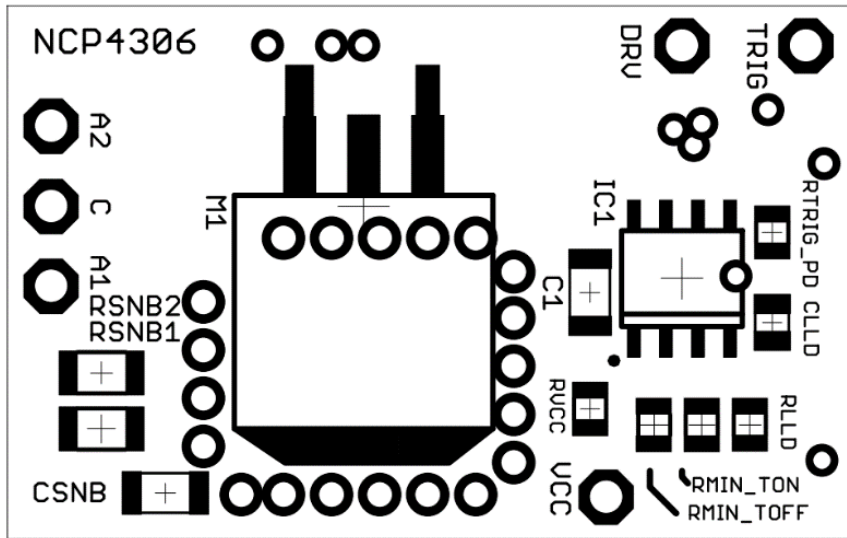

Figure 6. Top Side Components

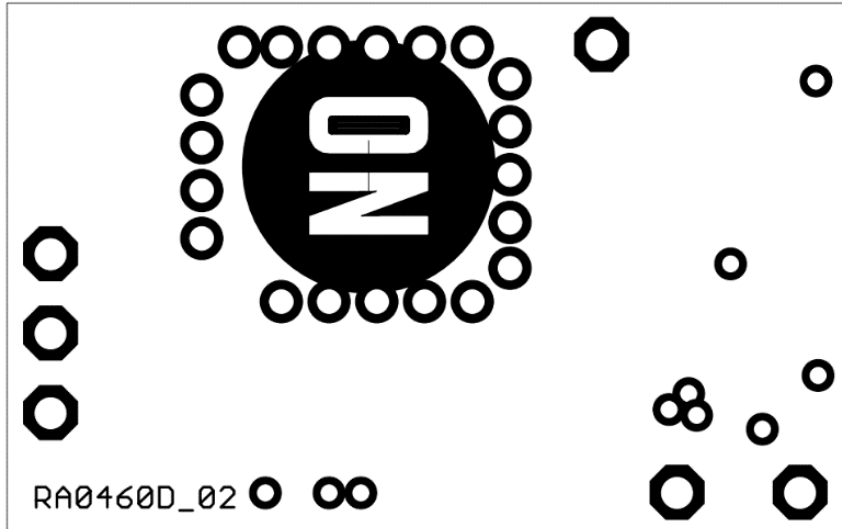

Figure 7. Bottom Side Components

EVBUM2520/D

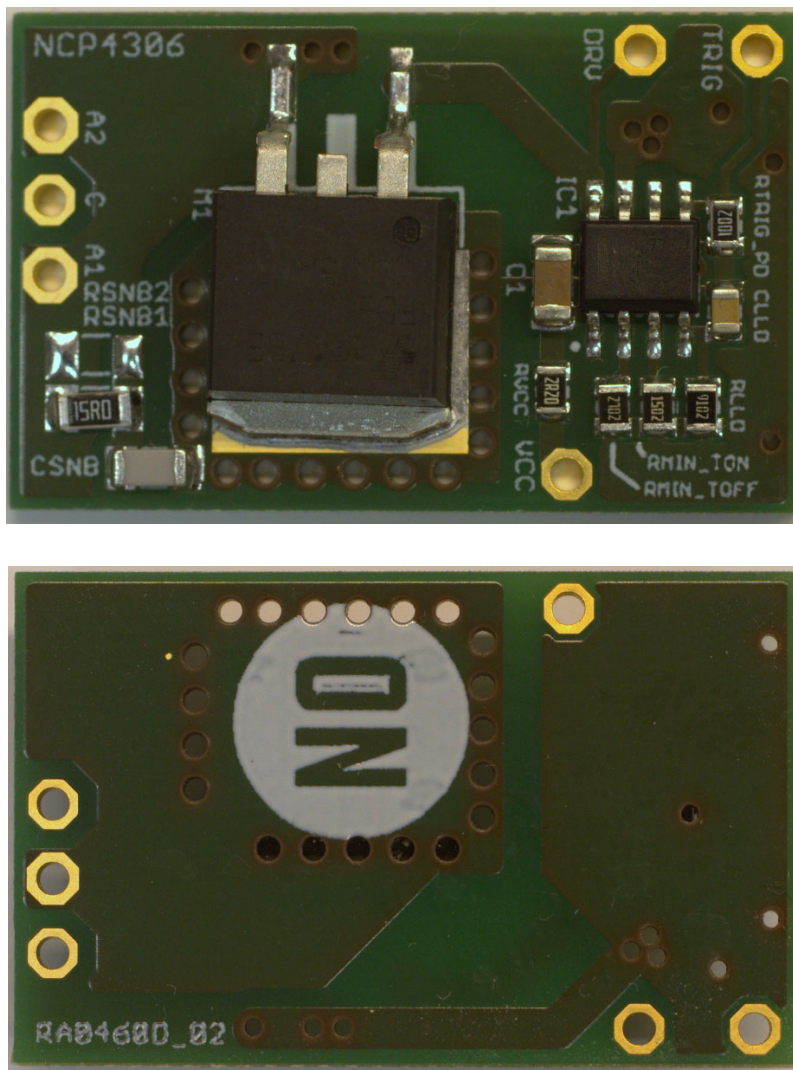

Figure 8. Evaluation Board Photos

EVBUM2520/D

BILL OF MATERIAL

Table 2. BILL OF MATERIAL FOR THE NCP4306 PUT-IN BOARD D2PAK 150 V

Designator	Qty	Description	Value	Tolerance	Footprint	Manufacturer	Manufacturer Part Number	Substitution Allowed
C1	1	Ceramic Capacitor	2.2 μ F / 50 V	10%	1206	KEMET	C1206C225K5RACTU	Yes
CLLD	1	Ceramic Capacitor	1n	20%	0805	KEMET	C0805C102M5RACTU	Yes
CSNB	1	Ceramic Capacitor	1n2	5%	1206	TDK Corporation	C3216C0G2J122J085AA	Yes
IC1	1	Secondary Side Synchronous Rectification Controller	NCP4306AADZZA	-	SOIC-08	ON Semiconductor	NCP4306AADZZAD R2G	No
M1	1	N-Channel Power MOSFET	FDB110N15A	-	D2PAK	ON Semiconductor	FDB110N15A	Yes
RVCC	1	Resistor SMD	2.2 Ω	1%	0805	YAGEO	RC0805FR-072R2L	Yes
RLLD	1	Resistor SMD	91 k Ω	1%	0805	YAGEO	RC0805FR-0791KL	Yes
R _{MIN_TOFF}	1	Resistor SMD	27 k Ω	1%	0805	YAGEO	RC0805FR-0727KL	Yes
R _{MIN_TON}	1	Resistor SMD	15 k Ω	1%	0805	YAGEO	RC0805FR-0715KL	Yes
R _{TRIG_PD}	1	Resistor SMD	10 k Ω	1%	0805	YAGEO	RC0805FR-0710KL	Yes
RSNB1	1	Resistor SMD	15 Ω	1%	1206	YAGEO	RC1206FR-0715RL	Yes
RSNB2	1	Resistor SMD	NU	-	1206	-	-	Yes

NOTE: All components are Pb-Free.

onsemi, **Onsemi**, and other names, marks, and brands are registered and/or common law trademarks of Semiconductor Components Industries, LLC dba "**onsemi**" or its affiliates and/or subsidiaries in the United States and/or other countries. **onsemi** owns the rights to a number of patents, trademarks, copyrights, trade secrets, and other intellectual property. A listing of **onsemi's** product/patent coverage may be accessed at www.onsemi.com/site/pdf/Patent-Marking.pdf. **onsemi** is an Equal Opportunity/Affirmative Action Employer. This literature is subject to all applicable copyright laws and is not for resale in any manner.

The evaluation board/kit (research and development board/kit) (hereinafter the "board") is not a finished product and is not available for sale to consumers. The board is only intended for research, development, demonstration and evaluation purposes and will only be used in laboratory/development areas by persons with an engineering/technical training and familiar with the risks associated with handling electrical/mechanical components, systems and subsystems. This person assumes full responsibility/liability for proper and safe handling. Any other use, resale or redistribution for any other purpose is strictly prohibited.

THE BOARD IS PROVIDED BY ONSEMI TO YOU "AS IS" AND WITHOUT ANY REPRESENTATIONS OR WARRANTIES WHATSOEVER. WITHOUT LIMITING THE FOREGOING, ONSEMI (AND ITS LICENSORS/SUPPLIERS) HEREBY DISCLAIMS ANY AND ALL REPRESENTATIONS AND WARRANTIES IN RELATION TO THE BOARD, ANY MODIFICATIONS, OR THIS AGREEMENT, WHETHER EXPRESS, IMPLIED, STATUTORY OR OTHERWISE, INCLUDING WITHOUT LIMITATION ANY AND ALL REPRESENTATIONS AND WARRANTIES OF MERCHANTABILITY, FITNESS FOR A PARTICULAR PURPOSE, TITLE, NON-INFRINGEMENT, AND THOSE ARISING FROM A COURSE OF DEALING, TRADE USAGE, TRADE CUSTOM OR TRADE PRACTICE.

onsemi reserves the right to make changes without further notice to any board.

You are responsible for determining whether the board will be suitable for your intended use or application or will achieve your intended results. Prior to using or distributing any systems that have been evaluated, designed or tested using the board, you agree to test and validate your design to confirm the functionality for your application. Any technical, applications or design information or advice, quality characterization, reliability data or other services provided by **onsemi** shall not constitute any representation or warranty by **onsemi**, and no additional obligations or liabilities shall arise from **onsemi** having provided such information or services.

onsemi products including the boards are not designed, intended, or authorized for use in life support systems, or any FDA Class 3 medical devices or medical devices with a similar or equivalent classification in a foreign jurisdiction, or any devices intended for implantation in the human body. You agree to indemnify, defend and hold harmless **onsemi**, its directors, officers, employees, representatives, agents, subsidiaries, affiliates, distributors, and assigns, against any and all liabilities, losses, costs, damages, judgments, and expenses, arising out of any claim, demand, investigation, lawsuit, regulatory action or cause of action arising out of or associated with any unauthorized use, even if such claim alleges that **onsemi** was negligent regarding the design or manufacture of any products and/or the board.

This evaluation board/kit does not fall within the scope of the European Union directives regarding electromagnetic compatibility, restricted substances (RoHS), recycling (WEEE), FCC, CE or UL, and may not meet the technical requirements of these or other related directives.

FCC WARNING – This evaluation board/kit is intended for use for engineering development, demonstration, or evaluation purposes only and is not considered by **onsemi** to be a finished end product fit for general consumer use. It may generate, use, or radiate radio frequency energy and has not been tested for compliance with the limits of computing devices pursuant to part 15 of FCC rules, which are designed to provide reasonable protection against radio frequency interference. Operation of this equipment may cause interference with radio communications, in which case the user shall be responsible, at its expense, to take whatever measures may be required to correct this interference.

onsemi does not convey any license under its patent rights nor the rights of others.

LIMITATIONS OF LIABILITY: **onsemi** shall not be liable for any special, consequential, incidental, indirect or punitive damages, including, but not limited to the costs of requalification, delay, loss of profits or goodwill, arising out of or in connection with the board, even if **onsemi** is advised of the possibility of such damages. In no event shall **onsemi's** aggregate liability from any obligation arising out of or in connection with the board, under any theory of liability, exceed the purchase price paid for the board, if any.

The board is provided to you subject to the license and other terms per **onsemi's** standard terms and conditions of sale. For more information and documentation, please visit www.onsemi.com.

PUBLICATION ORDERING INFORMATION

LITERATURE FULFILLMENT:

Email Requests to: orderlit@onsemi.com

onsemi Website: www.onsemi.com

TECHNICAL SUPPORT

North American Technical Support:

Voice Mail: 1 800-282-9855 Toll Free USA/Canada

Phone: 011 421 33 790 2910

Europe, Middle East and Africa Technical Support:

Phone: 00421 33 790 2910

For additional information, please contact your local Sales Representative