

CIRCUIT	PART NO.	DIM A	COLOR
2	171692-0202	8.35	BLACK
4	171692-0204	12.05	
6	171692-0206	17.75	
8	171692-0208	23.45	
10	171692-0210	29.15	
12	171692-0212	34.85	

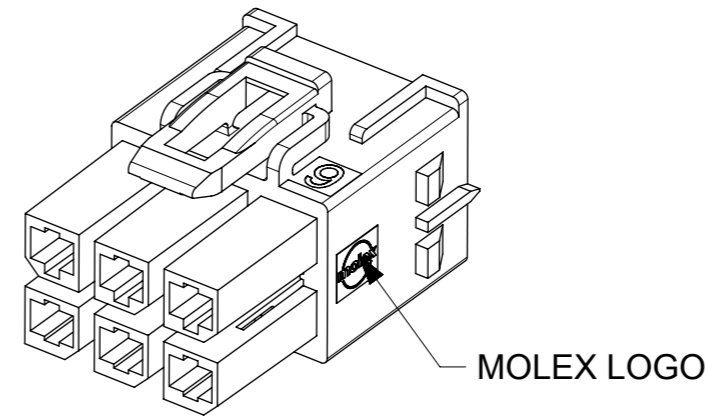

NOTES:

- MATERIAL :**
 NYLON, UL 94V-0 AND GLOW WIRE CAPABLE PER IEC60335-1.
 COLOR BLACK .
- PART USED WITH MOLEX SERIES.**
 HEADER:76829,172065;76825,172064
 PLUG: 105411
 TPA-CAPABLE FEMALE TERMINAL:76823,172063
 TPA:105415
- PRODUCT SPECIFICATION:**1054171000-PS/1720631000-PS
- PAKAGING SPECIFICATION:**1716920200
- APPLICATION SPECIFICATION:**768232000-AS

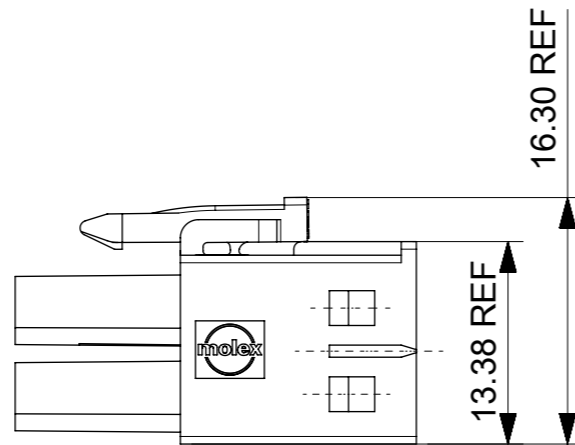
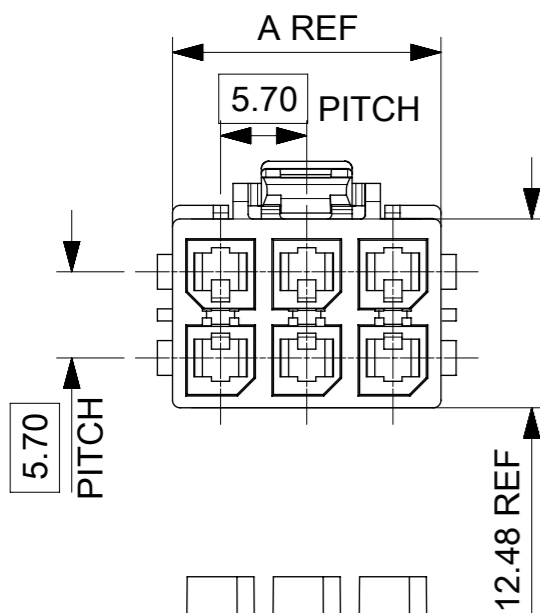
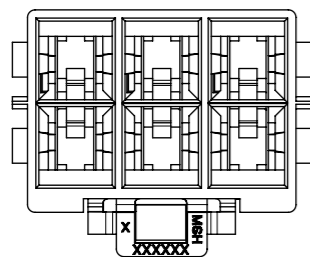
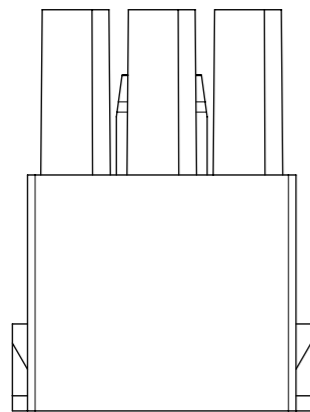

THIS DRAWING CONTAINS INFORMATION THAT IS PROPRIETARY TO MOLEX ELECTRONIC TECHNOLOGIES, LLC AND SHOULD NOT BE USED WITHOUT WRITTEN PERMISSION									
DIMENSION UNITS	SCALE	CURRENT REV DESC:			molex				
mm									
GENERAL TOLERANCES (UNLESS SPECIFIED)					MEGA-FIT RECEPTACLE DR TPA				
ANGULAR TOL	± 0.5 °	EC NO: 628261			PRODUCT CUSTOMER DRAWING				
4 PLACES	±	DRWN: ALUO02 2019/11/14			DOCUMENT NUMBER				
3 PLACES	±	CHK'D: AYIN 2019/12/11			1716920200				
2 PLACES	± 0.25	APPR: AYIN 2019/12/11			DOC TYPE				
1 PLACE	± 0.35	INITIAL REVISION:			PSD				
0 PLACES	±	DRWN: YXZHENG 2016/12/15			DOC PART				
DRAFT WHERE APPLICABLE MUST REMAIN WITHIN DIMENSIONS					000				
THIRD ANGLE PROJECTION					REVISION				
DRAWING					D1				
SERIES					SHEET NUMBER				
A3-SIZE 171692					1 OF 2				
MATERIAL NUMBER					CUSTOMER				
SEE CHART					GENERAL MARKET				

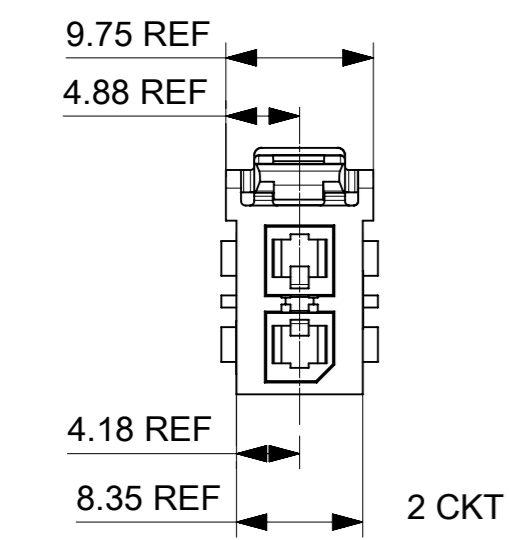

2 CKT

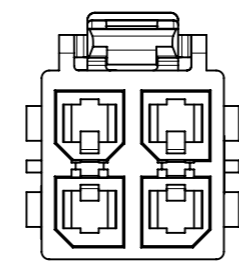
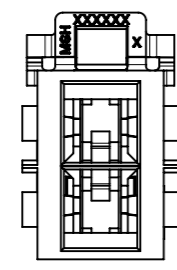

4 CKT

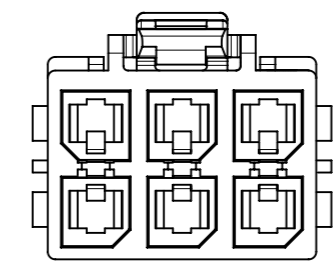
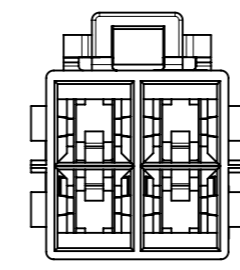

6 CKT

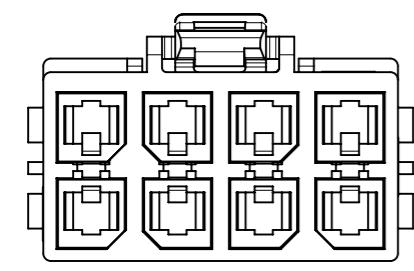
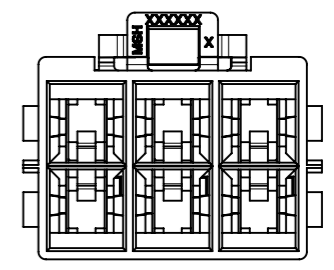

8 CKT

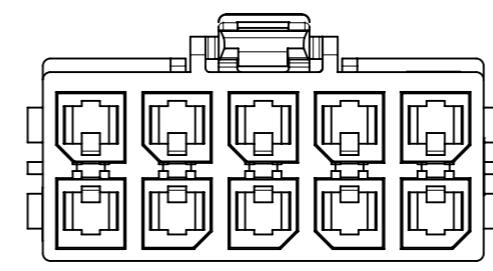
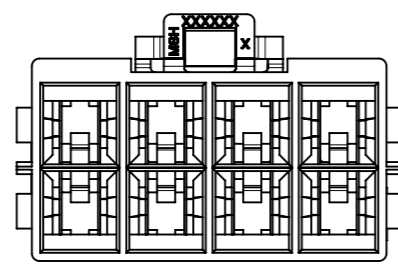

10 CKT

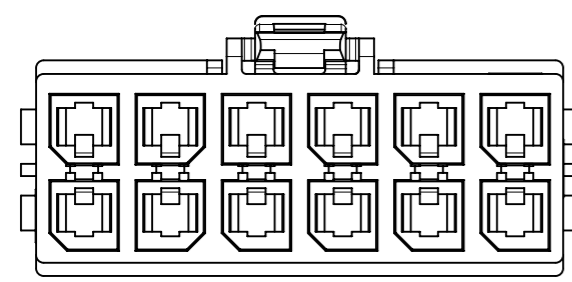
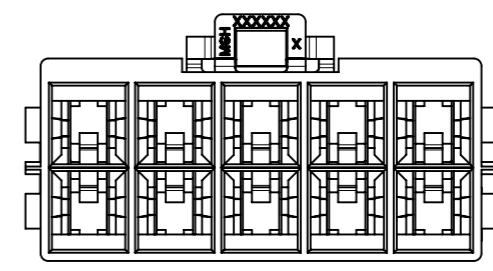

12 CKT

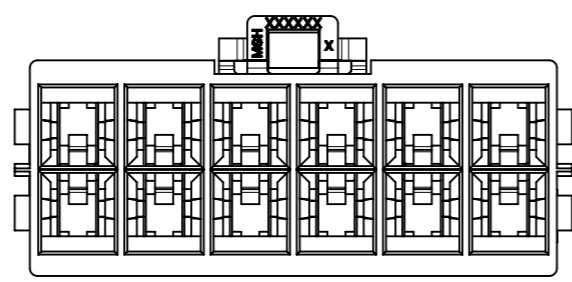

THIS DRAWING CONTAINS INFORMATION THAT IS PROPRIETARY TO MOLEX ELECTRONIC TECHNOLOGIES, LLC AND SHOULD NOT BE USED WITHOUT WRITTEN PERMISSION									
DIMENSION UNITS		SCALE		CURRENT REV DESC:				molex	
mm									
GENERAL TOLERANCES (UNLESS SPECIFIED)				EC NO: 628261				MEGA-FIT RECEPTACLE DR TPA	
ANGULAR TOL ± 0.5°				DRWN: ALUO02 2019/11/14					
4 PLACES ±				CHK'D: AYIN 2019/12/11					
3 PLACES ±				APPR: AYIN 2019/12/11					
2 PLACES ± 0.25				INITIAL REVISION:				PRODUCT CUSTOMER DRAWING	
1 PLACE ± 0.35				DRWN: YXZHENG 2016/12/15				DOCUMENT NUMBER	
0 PLACES ±				APPR: YXZHENG 2018/08/06				1716920200	
DRAFT WHERE APPLICABLE MUST REMAIN WITHIN DIMENSIONS		THIRD ANGLE PROJECTION		DRAWING		SERIES		MATERIAL NUMBER	
				A3-SIZE		171692		SEE CHART	
				CUSTOMER		REVISION		SHEET NUMBER	
				GENERAL MARKET		D1		2 OF 2	