

ALF70G912KP200

Aliases (A556KW912M200G)

ALF70, Aluminum Electrolytic, 9,100 uF, 20%, 200 VDC, -40/+85°C

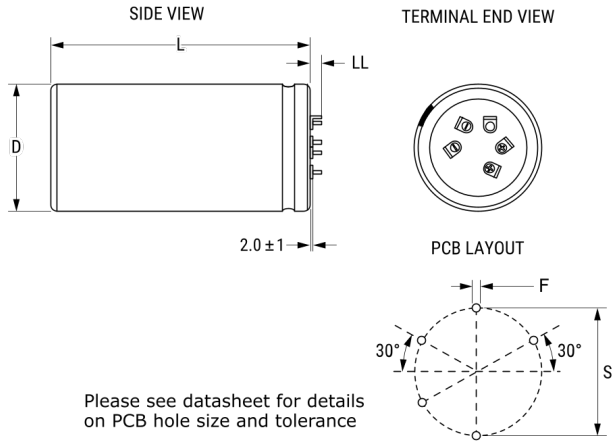

Click [here](#) for the 3D model.

Dimensions

D	50mm +1mm
L	105mm +/-2mm
S	25mm +/-0.1mm
LL	5.5mm +/-1mm
F	1.486mm +/-0.076mm

Packaging Specifications

Sleeving	Yes
Packaging	Bulk

General Information

Series	ALF70
Dielectric	Aluminum Electrolytic
Style	Press-Fit
Description	Press-Fit, Aluminum Electrolytic
RoHS	Yes
Lead	5 Pin Press-Fit
AEC-Q200	No
Halogen Free	Yes
Component Weight	310 g
Notes	Dimensions D And L Include Sleeving.
Shelf Life	156 Weeks

Specifications

Capacitance	9,100 uF
Capacitance Tolerance	20%
Voltage DC	200 VDC, 230 VDC (Surge)
Temperature Range	-40/+85°C
Rated Temperature	85°C
Life	18000 Hrs (Rated Voltage and Ripple Current at 85C), 29000 Hrs (Rated Voltage at 85C)
Resistance	29.47 mOhms (100Hz 20C), 20.04 mOhms (10kHz 20C)
Ripple Current	11.39 Amps (100Hz 85C), 16.89 Amps (10kHz 85C)
Leakage Current	6000 uA (5min 20°C)