

Data sheet | Item number: 235-408/331-000

PCB terminal block; push-button; 1.5 mm<sup>2</sup>; Pin spacing 5/5.08 mm; 8-pole;  
Push-in CAGE CLAMP®; 1,50 mm<sup>2</sup>; gray

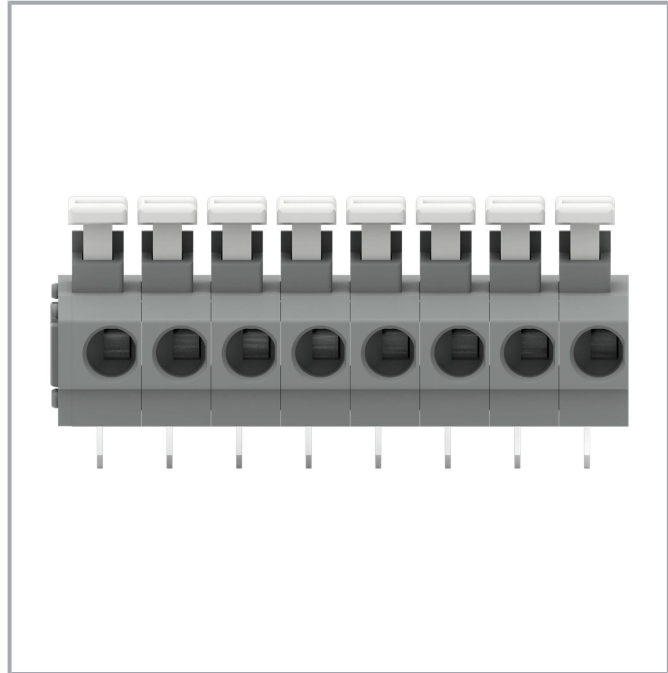

[www.wago.com/235-408/331-000](http://www.wago.com/235-408/331-000)

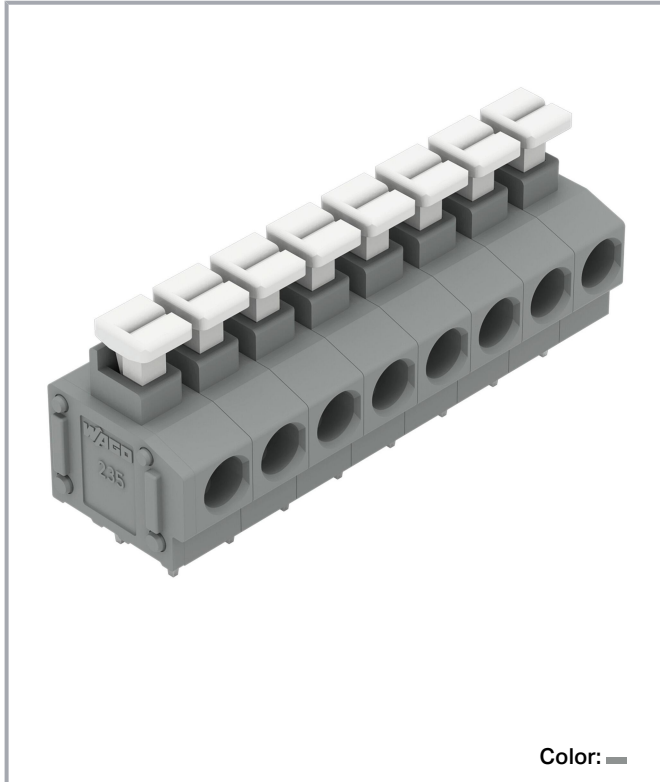

Subject to changes. Please also observe the further product documentation!

WAGO GmbH & Co. KG  
Hansastr. 27  
32423 Minden  
Phone: +49571 887-0 | Fax: +49571 887-169  
Email: [info.de@wago.com](mailto:info.de@wago.com) | Web: [www.wago.com](http://www.wago.com)

Do you have any questions about our products?  
We are always happy to take your call at +49 (571) 887-44222.

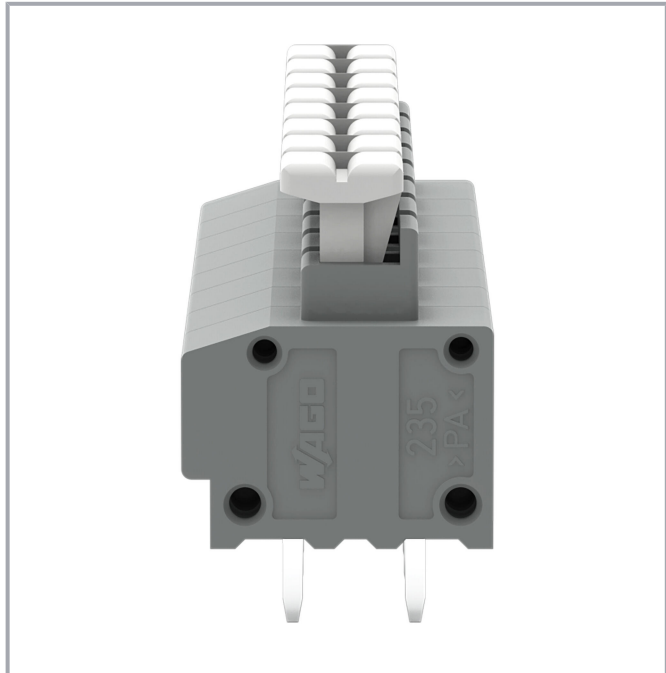
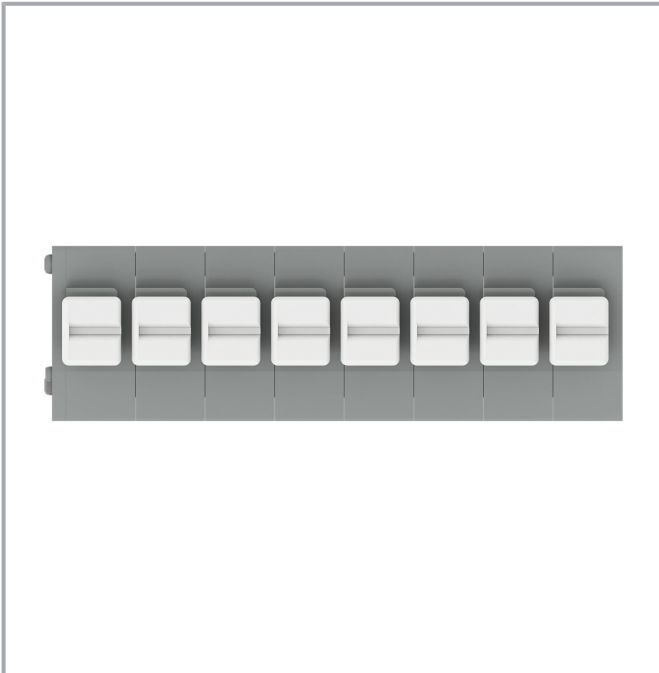

**Current-Carrying Capacity Curve**

Pin spacing: 5 mm / Conductor cross-section: 1.5 mm<sup>2</sup> "e"  
Based on: EN 60512-5-2 / Reduction factor: 1

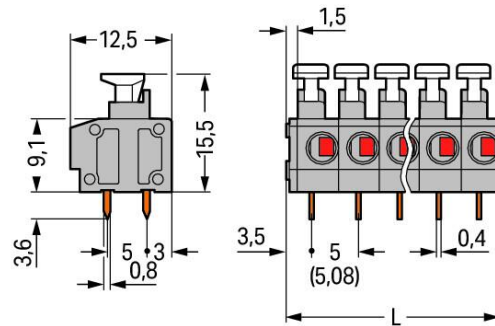
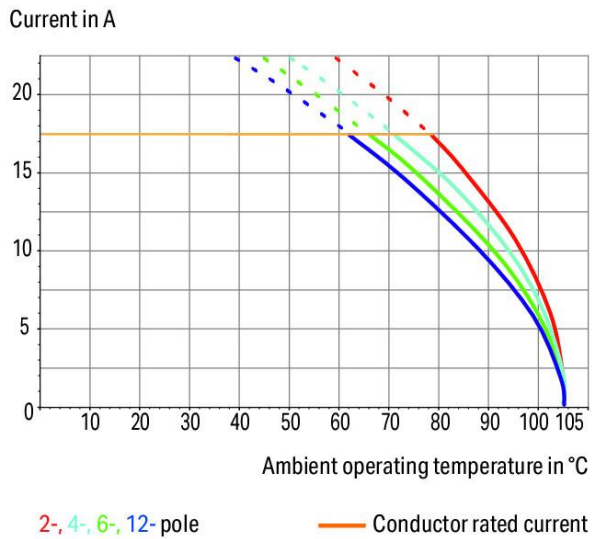

Dimensions in mm

$L = (\text{pole no.} \times \text{pin spacing}) + 1.5 \text{ mm}$

Subject to changes. Please also observe the further product documentation!

WAGO GmbH & Co. KG  
Hansastr. 27  
32423 Minden  
Phone: +49571 887-0 | Fax: +49571 887-169  
Email: [info.de@wago.com](mailto:info.de@wago.com) | Web: [www.wago.com](http://www.wago.com)

Do you have any questions about our products?  
We are always happy to take your call at +49 (571) 887-44222.



## Item description

- PCB terminal strips with push-buttons
- Push-in termination of solid and ferruled conductors
- Convenient termination/removal of fine-stranded conductors via push-buttons
- Set to metric or inch pin spacing by compressing terminal strips or pulling them apart

## Data

### Notes

|           |  |
|-----------|--|
| Variants: | Other pole numbers   |
|           | Other colors   |
|           | Terminal strips with 7.5/7.62 mm and 10/10.16 mm pin spacing   |
|           | Mixed-color PCB connector strips   |
|           | Direct marking   |
|           | Other versions (or variants) can be requested from WAGO Sales or configured at <a href="https://configurator.wago.com/">https://configurator.wago.com/</a> . |

## Electrical data

### Ratings per IEC/EN

|                               |   |
|-------------------------------|---|
| Ratings per                   | IEC/EN 60664-1  |
| Nominal voltage (III/3)       | 250 V   |
| Rated impulse voltage (III/3) | 4 kV  |
| Rated voltage (III/2)         | 320 V   |
| Rated impulse voltage (III/2) | 4 kV  |
| Nominal voltage (II/2)        | 630 V   |
| Rated surge voltage (II/2)    | 4 kV  |
| Rated current                 | 17.5 A  |
| Legend (ratings)              | (III / 2) ≙ Overvoltage category III / Pollution degree 2 |

### Ratings per UL 1059

|                                |         |
|--------------------------------|---------|
| Approvals per                  | UL 1059 |
| Rated voltage UL (Use Group B) | 300 V   |
| Rated current UL (Use Group B) | 10 A    |
| Rated voltage UL (Use Group D) | 300 V   |
| Rated current UL (Use Group D) | 10 A    |

Subject to changes. Please also observe the further product documentation!

WAGO GmbH & Co. KG  
 Hansastr. 27  
 32423 Minden  
 Phone: +49571 887-0 | Fax: +49571 887-169  
 Email: [info.de@wago.com](mailto:info.de@wago.com) | Web: [www.wago.com](http://www.wago.com)

Do you have any questions about our products?  
 We are always happy to take your call at +49 (571) 887-44222.

## Ratings per CSA

|                                 |       |
|---------------------------------|-------|
| Approvals per                   | CSA   |
| Rated voltage CSA (Use Group B) | 300 V |
| Rated current CSA (Use Group B) | 15 A  |

## Connection data

|                            |   |
|----------------------------|---|
| Connection points          | 8 |
| Total number of potentials | 8 |
| Number of connection types | 1 |
| Number of levels           | 1 |

## Connection 1

|   |  |
|---|--|
| Connection technology                             | Push-in CAGE CLAMP®  |
| Actuation type                                    | Push-button  |
| Solid conductor                                   | 0.2 ... 1.5 mm <sup>2</sup> / 20 ... 14 AWG  |
| Fine-stranded conductor                           | 0.75 ... 1.5 mm <sup>2</sup> / 20 ... 14 AWG   |
| Fine-stranded conductor; with insulated ferrule   | 0.25 ... 1 mm <sup>2</sup>   |
| Fine-stranded conductor; with uninsulated ferrule | 0.25 ... 1 mm <sup>2</sup>   |
| Note (conductor cross-section)                    | Fine-stranded conductor 0,25 ... 0,5 mm <sup>2</sup> (I max. 2 A)<br>Fine-stranded conductor 0,75 ... 1,5 mm <sup>2</sup> (I max. 6 A) |
| Strip length                                      | 9 ... 10 mm / 0.35 ... 0.39 inches   |
| Conductor connection direction to PCB             | 0°   |
| Pole number                                       | 8  |

## Physical data

|                                      |                              |
|--------------------------------------|------------------------------|
| Pin spacing                          | 5/5.08 mm / 0.197/0.2 inches |
| Width                                | 41.5 mm / 1.634 inches       |
| Height                               | 19.1 mm / 0.752 inches       |
| Height from the surface              | 15.5 mm / 0.61 inches        |
| Depth                                | 12.5 mm / 0.492 inches       |
| Solder pin length                    | 3.6 mm                       |
| Solder pin dimensions                | 0.4 x 0.8 mm                 |
| Drilled hole diameter with tolerance | 1 <sup>(+0.1)</sup> mm       |

## Plug-in connection

|                                      |    |
|--------------------------------------|----|
| Plugging without loss of pin spacing | No |
|--------------------------------------|----|

Subject to changes. Please also observe the further product documentation!

## PCB contact

|                                     |  |
|-------------------------------------|--|
| PCB contact                         | THT                                      |
| Solder pin arrangement              | over the entire terminal strip (in-line) |
| Number of solder pins per potential | 2  |

## Material Data

|                             |  |
|-----------------------------|--|
| Note (material data)        | Information on material specifications can be found here |
| Color                       | gray   |
| Material group              | I  |
| Insulation material         | Polyamide (PA66)   |
| Flammability class per UL94 | V0   |
| Clamping spring material    | Chrome-nickel spring steel (CrNi)                        |
| Contact material            | Electrolytic copper (E <sub>Cu</sub> )                   |
| Contact plating             | Tin  |
| Fire load                   | 0.116 MJ   |
| Weight                      | 6.2 g  |

## Environmental requirements

|                         |                 |
|-------------------------|-----------------|
| Limit temperature range | -60 ... +105 °C |
|-------------------------|-----------------|

## Commercial data

|                       |                                |
|-----------------------|--------------------------------|
| Product Group         | 4 (Printed Circuit Connectors) |
| eCl@ss 10.0           | 27-44-04-01                    |
| eCl@ss 9.0            | 27-44-04-01                    |
| ETIM 8.0              | EC002643                       |
| ETIM 7.0              | EC002643                       |
| PU (SPU)              | 100 (25) pcs                   |
| Packaging type        | box                            |
| Country of origin     | CN                             |
| GTIN                  | 4055143258913                  |
| Customs tariff number | 85369010000                    |

Subject to changes. Please also observe the further product documentation!







## Environmental Product Compliance

RoHS Compliance Status

Compliant, No Exemption

## Approvals / Certificates

### General approvals

| Logo   | Approval                              | Additional Approval Text | Certificate name |
|--|---------------------------------------|--------------------------|------------------|
|    | CCA<br>DEKRA Certification B.V.       | EN 60947                 | NTR NL-7144      |
|    | CCA<br>DEKRA Certification B.V.       | EN 60998                 | NTR NL-6919      |
|    | CCA<br>DEKRA Certification B.V.       | EN 60947-7-4             | NTR NL-7774      |
|  | CSA<br>DEKRA Certification B.V.       | C22.2                    | 1673956          |
|  | KEMA/KEUR<br>DEKRA Certification B.V. | EN 60947                 | 2160584.38       |
|  | UL<br>UL International Germany GmbH   | -                        | E45172           |

### Declarations of conformity and manufacturer's declarations

| Logo   | Approval   | Additional Approval Text | Certificate name |
|--|--|--------------------------|------------------|
|  | EU-Declaration of Conformity<br>WAGO GmbH & Co. KG | -                        | -                |
|  | UK-Declaration of Conformity<br>WAGO GmbH & Co. KG | -                        | -                |



Subject to changes. Please also observe the further product documentation!

WAGO GmbH & Co. KG  
 Hansastr. 27  
 32423 Minden  
 Phone: +49571 887-0 | Fax: +49571 887-169  
 Email: [info.de@wago.com](mailto:info.de@wago.com) | Web: [www.wago.com](http://www.wago.com)

Do you have any questions about our products?  
 We are always happy to take your call at +49 (571) 887-44222.





## Approvals for marine applications





| Logo   | Approval  | Additional Approval Text | Certificate name         |
|--|---|--------------------------|--------------------------|
|  | <b>ABS</b><br>American Bureau of Shipping               | -                        | 19-<br>HG1869876-<br>PDA |
|  | <b>DNV GL</b><br>Det Norske Veritas, Germanischer Lloyd | -                        | TAE000016Z               |

## Optional accessories

## Tool

| Operating tool   |   |  |
|--|---|--|
|    | <b>Item no.: 210-657</b><br>Operating tool; Blade: 3.5 x 0.5 mm; with a partially insulated shaft; short; multicoloured | <a href="http://www.wago.com/210-657">www.wago.com/210-657</a> |
|  | <b>Item no.: 210-720</b><br>Operating tool; Blade: 3.5 x 0.5 mm; with a partially insulated shaft; multicoloured        | <a href="http://www.wago.com/210-720">www.wago.com/210-720</a> |

## Marking accessories

| Marking strip  |  |  |
|--|--|--|
|  | <b>Item no.: 210-332/500-202</b><br>Marking strips; as a DIN A4 sheet; MARKED; 1-16 (160x); Height of marker strip: 3 mm; Strip length 182 mm; Horizontal marking; Self-adhesive; white  | <a href="http://www.wago.com/210-332/500-202">www.wago.com/210-332/500-202</a> |
|  | <b>Item no.: 210-332/500-206</b><br>Marking strips; as a DIN A4 sheet; MARKED; 33-48 (160x); Height of marker strip: 3 mm; Strip length 182 mm; Horizontal marking; Self-adhesive; white | <a href="http://www.wago.com/210-332/500-206">www.wago.com/210-332/500-206</a> |
|  | <b>Item no.: 210-332/500-205</b><br>Marking strips; as a DIN A4 sheet; MARKED; 1-32 (80x); Height of marker strip: 3 mm; Strip length 182 mm; Horizontal marking; Self-adhesive; white   | <a href="http://www.wago.com/210-332/500-205">www.wago.com/210-332/500-205</a> |
|  | <b>Item no.: 210-332/508-202</b><br>Marking strips; as a DIN A4 sheet; MARKED; 1-16 (160x); Height of marker strip: 3 mm; Strip length 182 mm; Horizontal marking; Self-adhesive; white  | <a href="http://www.wago.com/210-332/508-202">www.wago.com/210-332/508-202</a> |

Subject to changes. Please also observe the further product documentation!

|  |  |  |
|--|--|--|
|  | <b>Item no.: 210-332/500-204</b><br>Marking strips; as a DIN A4 sheet; MARKED; 17-32 (160x); Height of marker strip: 3 mm; Strip length 182 mm; Horizontal marking; Self-adhesive; white | <a href="http://www.wago.com/210-332/500-204">www.wago.com/210-332/500-204</a> |
|  | <b>Item no.: 210-332/508-204</b><br>Marking strips; as a DIN A4 sheet; MARKED; 17-32 (160x); Height of marker strip: 3 mm; Strip length 182 mm; Horizontal marking; Self-adhesive; white | <a href="http://www.wago.com/210-332/508-204">www.wago.com/210-332/508-204</a> |
|  | <b>Item no.: 210-332/508-206</b><br>Marking strips; as a DIN A4 sheet; MARKED; 33-48 (160x); Height of marker strip: 3 mm; Strip length 182 mm; Horizontal marking; Self-adhesive; white | <a href="http://www.wago.com/210-332/508-206">www.wago.com/210-332/508-206</a> |
|  | <b>Item no.: 210-332/508-205</b><br>Marking strips; as a DIN A4 sheet; MARKED; 1-32 (80x); Height of marker strip: 3 mm; Strip length 182 mm; Horizontal marking; Self-adhesive; white   | <a href="http://www.wago.com/210-332/508-205">www.wago.com/210-332/508-205</a> |

**Ferrule**

| Ferrule   |  |  |
|---|--|--|
|    | <b>Item no.: 216-101</b><br>Ferrule; Sleeve for 0.5 mm <sup>2</sup> / AWG 22; uninsulated; electro-tin plated; silver-colored  | <a href="http://www.wago.com/216-101">www.wago.com/216-101</a> |
|    | <b>Item no.: 216-102</b><br>Ferrule; Sleeve for 0.75 mm <sup>2</sup> / AWG 20; uninsulated; electro-tin plated; silver-colored   | <a href="http://www.wago.com/216-102">www.wago.com/216-102</a> |
|    | <b>Item no.: 216-103</b><br>Ferrule; Sleeve for 1 mm <sup>2</sup> / AWG 18; uninsulated; electro-tin plated  | <a href="http://www.wago.com/216-103">www.wago.com/216-103</a> |
|  | <b>Item no.: 216-123</b><br>Ferrule; Sleeve for 1 mm <sup>2</sup> / AWG 18; uninsulated; electro-tin plated; silver-colored  | <a href="http://www.wago.com/216-123">www.wago.com/216-123</a> |
|  | <b>Item no.: 216-122</b><br>Ferrule; Sleeve for 0.75 mm <sup>2</sup> / AWG 20; uninsulated; electro-tin plated; silver-colored   | <a href="http://www.wago.com/216-122">www.wago.com/216-122</a> |
|  | <b>Item no.: 216-142</b><br>Ferrule; Sleeve for 0.75 mm <sup>2</sup> / 18 AWG; uninsulated; electro-tin plated; electrolytic copper; gastight crimped; acc. to DIN 46228, Part 1/08.92 | <a href="http://www.wago.com/216-142">www.wago.com/216-142</a> |
|  | <b>Item no.: 216-132</b><br>Ferrule; Sleeve for 0.34 mm <sup>2</sup> / AWG 24; uninsulated; electro-tin plated   | <a href="http://www.wago.com/216-132">www.wago.com/216-132</a> |
|  | <b>Item no.: 216-121</b><br>Ferrule; Sleeve for 0.5 mm <sup>2</sup> / AWG 22; uninsulated; electro-tin plated; silver-colored  | <a href="http://www.wago.com/216-121">www.wago.com/216-121</a> |
|  | <b>Item no.: 216-143</b><br>Ferrule; Sleeve for 1 mm <sup>2</sup> / AWG 18; uninsulated; electro-tin plated; electrolytic copper; gastight crimped; acc. to DIN 46228, Part 1/08.92    | <a href="http://www.wago.com/216-143">www.wago.com/216-143</a> |
|  | <b>Item no.: 216-131</b><br>Ferrule; Sleeve for 0.25 mm <sup>2</sup> / AWG 24; uninsulated; electro-tin plated; silver-colored   | <a href="http://www.wago.com/216-131">www.wago.com/216-131</a> |
|  | <b>Item no.: 216-141</b><br>Ferrule; Sleeve for 0.5 mm <sup>2</sup> / 20 AWG; uninsulated; electro-tin plated; electrolytic copper; gastight crimped; acc. to DIN 46228, Part 1/08.92  | <a href="http://www.wago.com/216-141">www.wago.com/216-141</a> |
|  | <b>Item no.: 216-152</b>   |  |

Subject to changes. Please also observe the further product documentation!





|  |  |  |
|--|--|--|
|  | Ferrule; Sleeve for 0.34 mm <sup>2</sup> / AWG 24; uninsulated; electro-tin plated   | <a href="http://www.wago.com/216-152">www.wago.com/216-152</a> |
|  | <b>Item no.: 216-203</b><br>Ferrule; Sleeve for 1 mm <sup>2</sup> / AWG 18; insulated; electro-tin plated; red   | <a href="http://www.wago.com/216-203">www.wago.com/216-203</a> |
|  | <b>Item no.: 216-202</b><br>Ferrule; Sleeve for 0.75 mm <sup>2</sup> / 18 AWG; insulated; electro-tin plated; gray   | <a href="http://www.wago.com/216-202">www.wago.com/216-202</a> |
|  | <b>Item no.: 216-151</b><br>Ferrule; Sleeve for 0.25 mm <sup>2</sup> / AWG 24; uninsulated; electro-tin plated   | <a href="http://www.wago.com/216-151">www.wago.com/216-151</a> |
|  | <b>Item no.: 216-201</b><br>Ferrule; Sleeve for 0.5 mm <sup>2</sup> / 20 AWG; insulated; electro-tin plated; white   | <a href="http://www.wago.com/216-201">www.wago.com/216-201</a> |
|  | <b>Item no.: 216-223</b><br>Ferrule; Sleeve for 1 mm <sup>2</sup> / AWG 18; insulated; electro-tin plated; red   | <a href="http://www.wago.com/216-223">www.wago.com/216-223</a> |
|  | <b>Item no.: 216-241</b><br>Ferrule; Sleeve for 0.5 mm <sup>2</sup> / 20 AWG; insulated; electro-tin plated; electrolytic copper; gastight crimped; acc. to DIN 46228, Part 4/09.90; white | <a href="http://www.wago.com/216-241">www.wago.com/216-241</a> |
|  | <b>Item no.: 216-242</b><br>Ferrule; Sleeve for 0.75 mm <sup>2</sup> / 18 AWG; insulated; electro-tin plated; electrolytic copper; gastight crimped; acc. to DIN 46228, Part 4/09.90; gray | <a href="http://www.wago.com/216-242">www.wago.com/216-242</a> |
|  | <b>Item no.: 216-222</b><br>Ferrule; Sleeve for 0.75 mm <sup>2</sup> / 18 AWG; insulated; electro-tin plated; gray   | <a href="http://www.wago.com/216-222">www.wago.com/216-222</a> |
|  | <b>Item no.: 216-221</b><br>Ferrule; Sleeve for 0.5 mm <sup>2</sup> / 20 AWG; insulated; electro-tin plated; white   | <a href="http://www.wago.com/216-221">www.wago.com/216-221</a> |
|  | <b>Item no.: 216-243</b><br>Ferrule; Sleeve for 1 mm <sup>2</sup> / AWG 18; insulated; electro-tin plated; electrolytic copper; gastight crimped; acc. to DIN 46228, Part 4/09.90; red     | <a href="http://www.wago.com/216-243">www.wago.com/216-243</a> |
|  | <b>Item no.: 216-263</b><br>Ferrule; Sleeve for 1 mm <sup>2</sup> / AWG 18; insulated; electro-tin plated; electrolytic copper; gastight crimped; acc. to DIN 46228, Part 4/09.90; red     | <a href="http://www.wago.com/216-263">www.wago.com/216-263</a> |
|  | <b>Item no.: 216-262</b><br>Ferrule; Sleeve for 0.75 mm <sup>2</sup> / 18 AWG; insulated; electro-tin plated; electrolytic copper; gastight crimped; acc. to DIN 46228, Part 4/09.90; gray | <a href="http://www.wago.com/216-262">www.wago.com/216-262</a> |
|  | <b>Item no.: 216-301</b><br>Ferrule; Sleeve for 0.25 mm <sup>2</sup> / AWG 24; insulated; electro-tin plated; yellow   | <a href="http://www.wago.com/216-301">www.wago.com/216-301</a> |
|  | <b>Item no.: 216-321</b><br>Ferrule; Sleeve for 0.25 mm <sup>2</sup> / AWG 24; insulated; electro-tin plated; yellow   | <a href="http://www.wago.com/216-321">www.wago.com/216-321</a> |
|  | <b>Item no.: 216-322</b><br>Ferrule; Sleeve for 0.34 mm <sup>2</sup> / 22 AWG; insulated; electro-tin plated; light turquoise  | <a href="http://www.wago.com/216-322">www.wago.com/216-322</a> |
|  | <b>Item no.: 216-302</b><br>Ferrule; Sleeve for 0.34 mm <sup>2</sup> / 22 AWG; insulated; electro-tin plated; light turquoise  | <a href="http://www.wago.com/216-302">www.wago.com/216-302</a> |

Subject to changes. Please also observe the further product documentation!



## Downloads

### Documentation

#### Additional Information

|                        |            |        |          |
|------------------------|------------|--------|----------|
| Technical Section      | 2019 Apr 3 | pdf    | Download |
| Technical explanations |            | 2.0 MB |          |

## CAD/CAE-Data

### CAD data

|                              |     |          |
|------------------------------|-----|----------|
| 2D/3D Models 235-408/331-000 | URL | Download |
|------------------------------|-----|----------|

### CAE data

|                                   |     |          |
|-----------------------------------|-----|----------|
| EPLAN Data Portal 235-408/331-000 | URL | Download |
|-----------------------------------|-----|----------|

|                              |     |          |
|------------------------------|-----|----------|
| ZUKEN Portal 235-408/331-000 | URL | Download |
|------------------------------|-----|----------|

|                                   |     |          |
|-----------------------------------|-----|----------|
| EPLAN Data Portal 235-408/331-000 | URL | Download |
|-----------------------------------|-----|----------|

### PCB Design

|                                      |     |          |
|--------------------------------------|-----|----------|
| Symbol and Footprint 235-408/331-000 | URL | Download |
|--------------------------------------|-----|----------|

CAX data for your PCB design, consisting of "schematic symbols and PCB footprints", allow easy integration of the WAGO component into your development environment.

### Supported formats:

- Accel EDA 14 & 15
- Altium 6 to current version
- Cadence Allegro
- DesignSpark
- Eagle Libraries
- KiCad
- Mentor Graphics BoardStation
- Mentor Graphics Design Architect
- Mentor Graphics Design Expedition 99 and 2000
- OrCAD 9.X PCB and Capture
- PADS PowerPCB 3, 3.5, 4.X, and 5.X
- PADS PowerPCB and PowerLogic 3.0
- PCAD 2000, 2001, 2002, 2004, and 2006

Subject to changes. Please also observe the further product documentation!

WAGO GmbH & Co. KG

Hansastr. 27

32423 Minden

Phone: +49571 887-0 | Fax: +49571 887-169

Email: [info.de@wago.com](mailto:info.de@wago.com) | Web: [www.wago.com](http://www.wago.com)

Do you have any questions about our products?

We are always happy to take your call at +49 (571) 887-44222.

- Pulsonix 8.5 or newer
- STL
- 3D STEP
- TARGET 3001!
- View Logic ViewDraw
- Quadcept
- Zuken CadStar 3 and 4
- Zuken CR-5000 and CR-8000

PCB Component Libraries (EDA), PCB CAD Library Ultra Librarian

---

## Environmental Product Compliance

### Compliance Search

Environmental Product Compliance 235-408/331-000

URL

Download

PCB terminal block; push-button; 1.5 mm<sup>2</sup>; Pin spacing 5/5.08 mm; 8-pole; Push-in CAGE CLAMP®; 1,50 mm<sup>2</sup>; gray

---

## Installation Notes

### Conductor termination

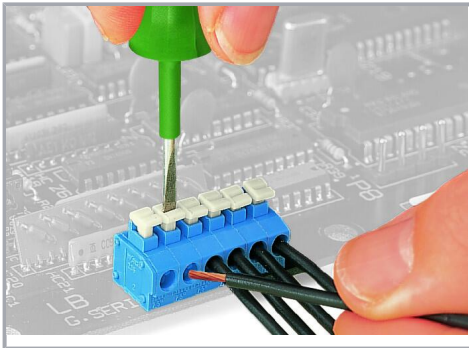

Inserting/removing fine-stranded conductors via push-button.

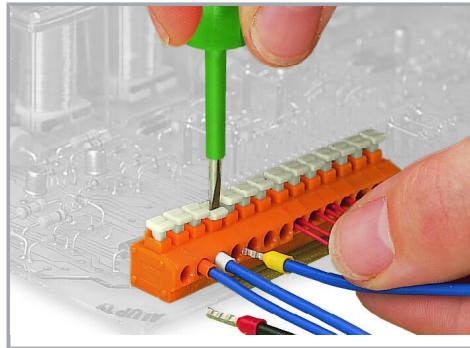

Insert/remove fine-stranded conductors with ferrules via push-button.

Subject to changes. Please also observe the further product documentation!

---

WAGO GmbH & Co. KG  
Hansastr. 27  
32423 Minden  
Phone: +49571 887-0 | Fax: +49571 887-169  
Email: [info.de@wago.com](mailto:info.de@wago.com) | Web: [www.wago.com](http://www.wago.com)

Do you have any questions about our products?  
We are always happy to take your call at +49 (571) 887-44222.

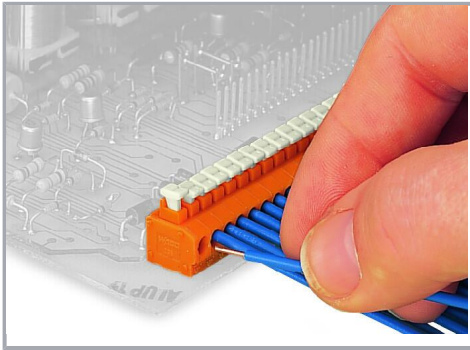

Insert solid conductors via push-in termination.

### Installation

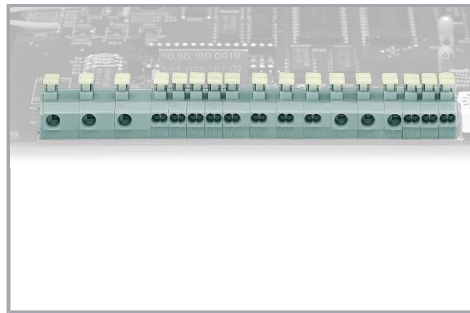
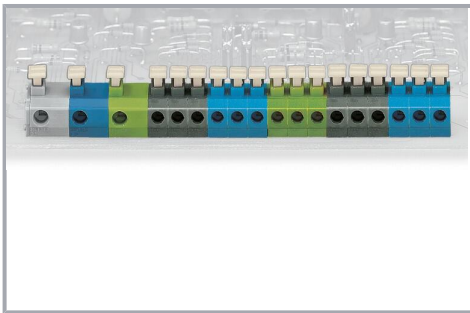

Combining 1- and 2-conductor terminal blocks with different pin spacing.

### Testing

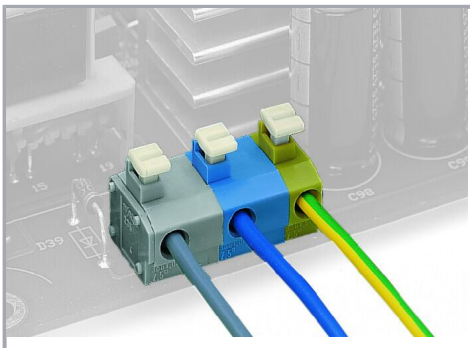

Application example: field-wiring terminal strip

Subject to changes. Please also observe the further product documentation!