

Core **UR59/36/17**

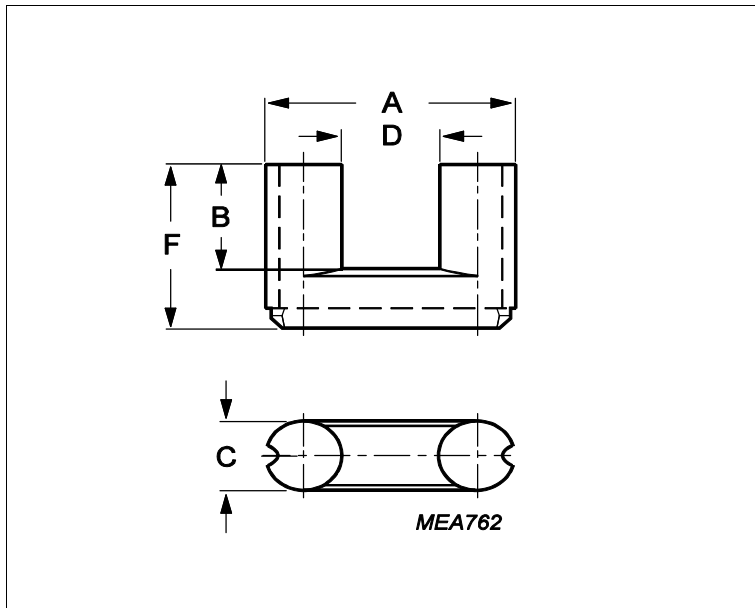

Effective parameters			
	Parameter	Value	Unit
$\Sigma(I/A)$	core factor (C1)	0.9	mm ⁻¹
Ve	effective volume	39700	mm ³
Le	effective length	189	mm
Ae	effective area	210	mm ²
Amin	minimum area		mm ²
m	UR59/36/17	≈ 99	g/pcs

Dimensions for product: UR59/36/17						
	Nom	Tol +	Tol -	Max	Min	Unit
A	59.34	1.75	1.75	61.09	57.59	mm
B	21.50	0.80	0.80	22.30	20.70	mm
C	17.00	0.40	0.40	17.40	16.60	mm
D	26.50	1.00	1.00	27.50	25.50	mm
F	35.80	0.20	0.20	36.00	35.60	mm

Inductance factor				
Material	Value	Tol +	Tol -	Unit
3C90	2900	25%	25%	nH/turns ²

Power loss: 3C90				
Measuring conditions			Max	Unit
25 kHz	200 mT	100 °C	4.800	W/set

Bsat					
Measuring conditions			Material	Min	Unit
10 kHz	250 A/m	100 °C	3C90	320	mT