

MOSFET – Complementary, POWERTRENCH®

N-Channel: 20 V, 3.8 A, 66 mΩ

P-Channel: -20 V, -2.6 A, 142 mΩ

FDME1034CZT

General Description

This device is designed specifically as a single package solution for a DC–DC ‘Switching’ MOSFET in cellular handset and other ultra–portable applications. It features an independent N–Channel & P–Channel MOSFET with low on–state resistance for minimum conduction losses. The gate charge of each MOSFET is also minimized to allow high frequency switching directly from the controlling device.

The MicroFET™ 1.6x1.6 Thin package offers exceptional thermal performance for its physical size and is well suited to switching and linear mode applications.

Features

Q1: N–Channel

- Max $R_{DS(on)}$ = 66 mΩ at $V_{GS} = 4.5$ V, $I_D = 3.4$ A
- Max $R_{DS(on)}$ = 86 mΩ at $V_{GS} = 2.5$ V, $I_D = 2.9$ A
- Max $R_{DS(on)}$ = 113 mΩ at $V_{GS} = 1.8$ V, $I_D = 2.5$ A
- Max $R_{DS(on)}$ = 160 mΩ at $V_{GS} = 1.5$ V, $I_D = 2.1$ A

Q2: P–Channel

- Max $R_{DS(on)}$ = 142 mΩ at $V_{GS} = -4.5$ V, $I_D = -2.3$ A
- Max $R_{DS(on)}$ = 213 mΩ at $V_{GS} = -2.5$ V, $I_D = -1.8$ A
- Max $R_{DS(on)}$ = 331 mΩ at $V_{GS} = -1.8$ V, $I_D = -1.5$ A
- Max $R_{DS(on)}$ = 530 mΩ at $V_{GS} = -1.5$ V, $I_D = -1.2$ A
- Low Profile: 0.55 mm Maximum in the New Package MicroFET 1.6x1.6 Thin
- Free from Halogenated Compounds and Antimony Oxides
- HBM ESD Protection Level > 1600 V (Note 3)
- This Device is Pb–Free and is RoHS Compliant

Applications

- DC–DC Conversion
- Level Shifted Load Switch

ELECTRICAL CONNECTION

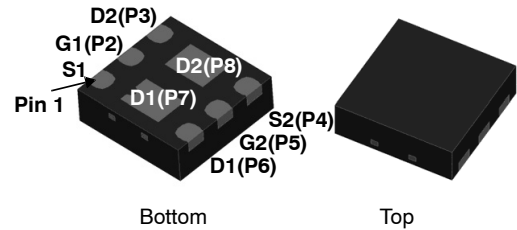
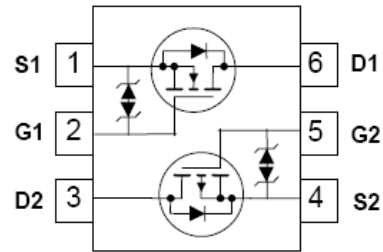

Note: Center pad of P7 & P8 is a virtual pin number. Actual P7 & P8 is connected to edge pad of P6 & P3 respectively.

UDFN6 1.6x1.6, 0.5P
CASE 517DW

MARKING DIAGRAM

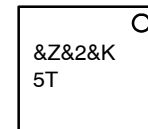

- &Z = Assembly Plant Code
- &2 = 2–Digit Date Code (YW)
- &K = 2–Digit Lot Traceability Code
- 5T = Specific Device Code

ORDERING INFORMATION

Device	Package	Shipping†
FDME1034CZT	UDFN6 (Pb–Free)	5,000 / Tape & Reel

†For information on tape and reel specifications, including part orientation and tape sizes, please refer to our Tape and Reel Packaging Specification Brochure, BRD8011/D.

FDME1034CZT

MOSFET MAXIMUM RATINGS (T_A = 25°C, Unless otherwise noted)

Symbol	Parameter	Q1	Q2	Units
V _{DS}	Drain to Source Voltage	20	-20	V
V _{GS}	Gate to Source Voltage	±8	±8	V
I _D	Drain Current –Continuous T _A = 25°C (Note 1a)	3.8	-2.6	A
	–Pulsed	6	-6	
P _D	Power Dissipation for Single Operation T _A = 25°C (Note 1a)	1.4		W
	Power Dissipation for Single Operation T _A = 25°C (Note 1b)	0.6		
T _J , T _{STG}	Operating and Storage Junction Temperature Range	-55 to +150		°C

Stresses exceeding those listed in the Maximum Ratings table may damage the device. If any of these limits are exceeded, device functionality should not be assumed, damage may occur and reliability may be affected.

THERMAL CHARACTERISTICS

Symbol	Parameter	Value	Units
R _{θJA}	Thermal Resistance, Junction to Ambient (Single Operation) (Note 1a)	90	°C/W
R _{θJA}	Thermal Resistance, Junction to Ambient (Single Operation) (Note 1b)	195	

ELECTRICAL CHARACTERISTICS (T_J = 25°C unless otherwise noted)

Symbol	Parameter	Test Conditions	Type	Min.	Typ.	Max.	Units
--------	-----------	-----------------	------	------	------	------	-------

OFF CHARACTERISTICS

BV _{DSS}	Drain to Source Breakdown Voltage	I _D = 250 μA, V _{GS} = 0 V I _D = -250 μA, V _{GS} = 0 V	Q1 Q2	20 -20	- -	- -	V
$\frac{\Delta BV_{DSS}}{\Delta T_J}$	Breakdown Voltage Temperature Coefficient	I _D = 250 μA, referenced to 25°C I _D = -250 μA, referenced to 25°C	Q1 Q2	- -	16 -12	- -	mV/°C
I _{DSS}	Zero Gate Voltage Drain Current	V _{DS} = 16 V, V _{GS} = 0 V V _{DS} = -16 V, V _{GS} = 0 V	Q1 Q2	- -	- -	1 -1	μA
I _{GSS}	Gate to Source Leakage Current	V _{GS} = ±8 V, V _{DS} = 0 V	All	-	-	±10	μA

ON CHARACTERISTICS

V _{GS(th)}	Gate to Source Threshold Voltage	V _{GS} = V _{DS} , I _D = 250 μA V _{GS} = V _{DS} , I _D = -250 μA	Q1 Q2	0.4 -0.4	0.7 -0.6	1.0 -1.0	V
$\frac{\Delta V_{GS(th)}}{\Delta T_J}$	Gate to Source Threshold Voltage Temperature Coefficient	I _D = 250 μA, referenced to 25°C I _D = -250 μA, referenced to 25°C	Q1 Q2	- -	-3 2	- -	mV/°C
R _{DS(on)}	Drain to Source On Resistance	V _{GS} = 4.5 V, I _D = 3.4 A V _{GS} = 2.5 V, I _D = 2.9 A V _{GS} = 1.8 V, I _D = 2.5 A V _{GS} = 1.5 V, I _D = 2.1 A V _{GS} = 4.5 V, I _D = 3.4 A, T _J = 125°C	Q1	- - - - -	55 68 85 106 76	66 86 113 160 112	mΩ
		V _{GS} = -4.5 V, I _D = -2.3 A V _{GS} = -2.5 V, I _D = -1.8 A V _{GS} = -1.8 V, I _D = -1.5 A V _{GS} = -1.5 V, I _D = -1.2 A V _{GS} = -4.5 V, I _D = -2.3 A, T _J = 125°C	Q2	- - - - -	95 120 150 190 128	142 213 331 530 190	
g _{FS}	Forward Transconductance	V _{DS} = 4.5 V, I _D = 3.4 A	Q1	-	9	-	S
		V _{DS} = -4.5 V, I _D = -2.3 A	Q2	-	7	-	

FDME1034CZT

ELECTRICAL CHARACTERISTICS ($T_J = 25^\circ\text{C}$ unless otherwise noted) (continued)

Symbol	Parameter	Test Conditions	Type	Min.	Typ.	Max.	Units
--------	-----------	-----------------	------	------	------	------	-------

DYNAMIC CHARACTERISTICS

C _{iss}	Input Capacitance	Q1: V _{DS} = 10 V, V _{GS} = 0 V, f = 1 MHz	Q1	-	225	300	pF
			Q2	-	305	405	
C _{oss}	Output Capacitance	Q2: V _{DS} = -10 V, V _{GS} = 0 V, f = 1 MHz	Q1	-	40	55	pF
			Q2	-	55	75	
C _{rss}	Reverse Transfer Capacitance		Q1	-	25	40	pF
			Q2	-	50	75	

SWITCHING CHARACTERISTICS

t _{d(on)}	Turn-On Delay Time	Q1: V _{DD} = 10 V, I _D = 1 A, V _{GS} = 4.5V, R _{GEN} = 6 Ω	Q1	-	4.5	10	ns
			Q2	-	4.7	10	
t _r	Rise Time	Q2: V _{DD} = -10 V, I _D = -1 A, V _{GS} = -4.5 V, R _{GEN} = 6 Ω	Q1	-	2.0	10	
			Q2	-	4.8	10	
t _{d(off)}	Turn-Off Delay Time		Q1	-	15	27	
			Q2	-	33	53	
t _f	Fall Time		Q1	-	1.7	10	
			Q2	-	16	29	
Q _g	Total Gate Charge	Q1: V _{DD} = 10 V, I _D = 3.4 A, V _{GS} = 4.5 V	Q1	-	3	4.2	nC
			Q2	-	5.5	7.7	
Q _{gs}	Gate to Source Gate Charge	Q2: V _{DD} = -10 V, I _D = -2.3 A, V _{GS} = -4.5 V	Q1	-	0.4	-	
			Q2	-	0.6	-	
Q _{gd}	Gate to Drain "Miller" Charge		Q1	-	0.6	-	
			Q2	-	1.4	-	

DRAIN-SOURCE DIODE CHARACTERISTICS $T_J = 25^\circ\text{C}$ unless otherwise noted.

V _{SD}	Source to Drain Diode Forward Voltage	V _{GS} = 0 V, I _S = 0.9 A (Note 2) V _{GS} = 0 V, I _S = -0.9 A (Note 2)	Q1	-	0.7	1.2	V
			Q2	-	-0.8	-1.2	
t _{rr}	Reverse Recovery Time	Q1: I _F = 3.4 A, Δi/Δt = 100 A/μs	Q1	-	8.5	17	ns
			Q2	-	16	29	
Q _{rr}	Reverse Recovery Charge	Q2: I _F = -2.3 A, Δi/Δt = 100 A/μs	Q1	-	1.4	10	nC
			Q2	-	4.4	10	

Product parametric performance is indicated in the Electrical Characteristics for the listed test conditions, unless otherwise noted. Product performance may not be indicated by the Electrical Characteristics if operated under different conditions.

NOTES:

- R_{θJA} is determined with the device mounted on a 1 in² pad 2 oz copper pad on a 1.5 x 1.5 in. board of FR-4 material. R_{θJC} is guaranteed by design while R_{θCA} is determined by the user's board design.

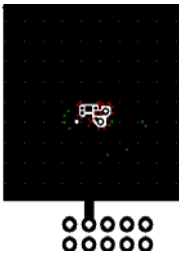

a. 90 °C/W when mounted on a 1 in² pad of 2 oz copper

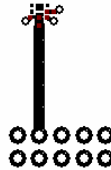

b. 195 °C/W when mounted on a minimum pad of 2 oz copper

- Pulse Test: Pulse Width < 300 μs, Duty cycle < 2.0 %.
- The diode connected between the gate and source serves only as protection ESD. No gate overvoltage rating is implied.

TYPICAL CHARACTERISTICS (Q1 N-CHANNEL) $T_J = 25^\circ\text{C}$ UNLESS OTHERWISE NOTED.

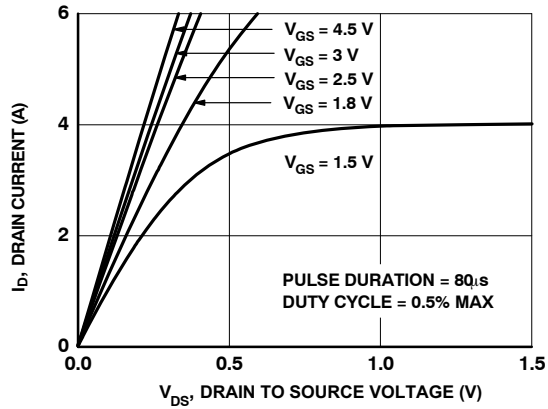

Figure 1. On-Region Characteristics

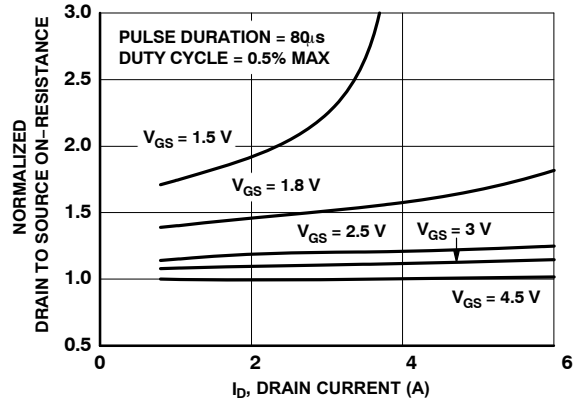

Figure 2. Normalized On-Resistance vs. Drain Current and Gate Voltage

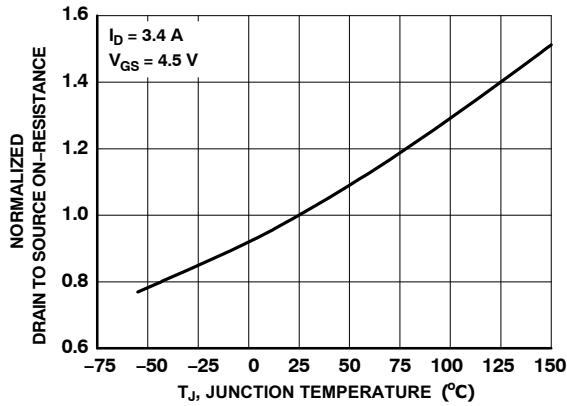

Figure 3. Normalized On Resistance vs. Junction Temperature

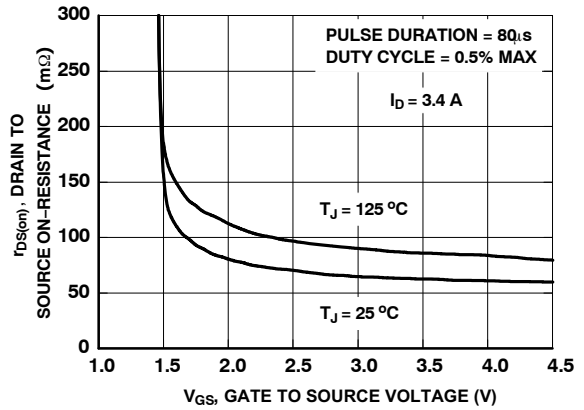

Figure 4. On-Resistance vs. Gate to Source Voltage

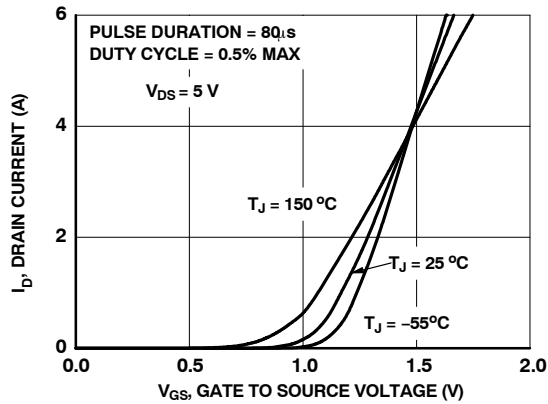

Figure 5. Transfer Characteristics

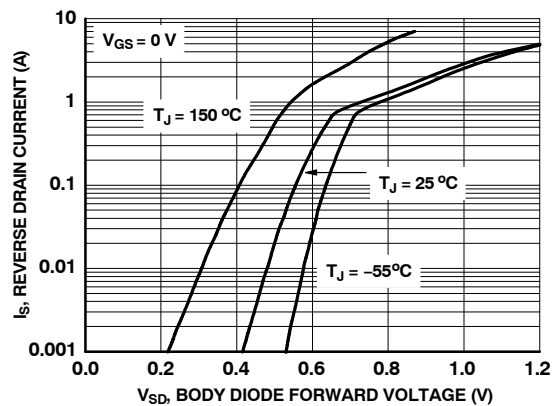

Figure 6. Source to Drain Diode Forward Voltage vs. Source Current

FDME1034CZT

TYPICAL CHARACTERISTICS (Q1 N-CHANNEL) $T_J = 25^\circ\text{C}$ UNLESS OTHERWISE NOTED.

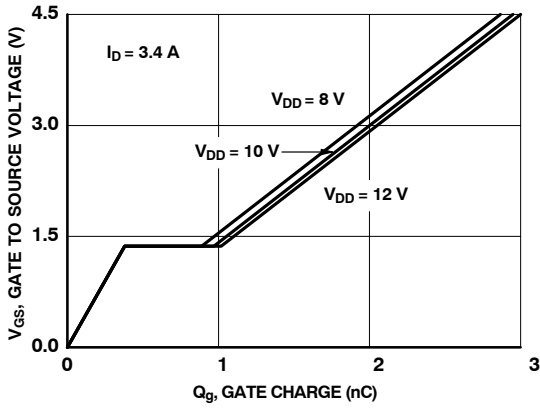

Figure 7. Gate Charge Characteristics

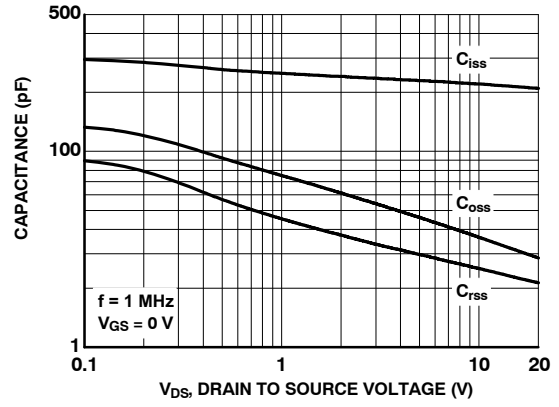

Figure 8. Capacitance vs. Drain to Source Voltage

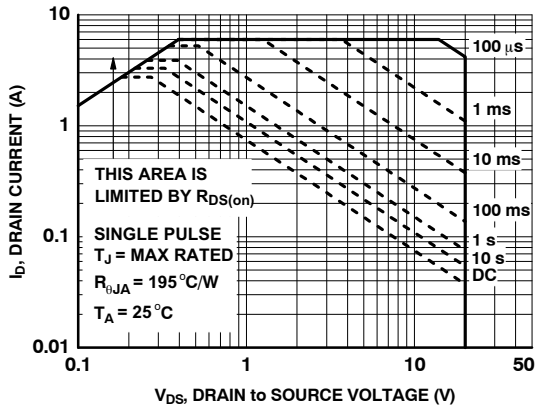

Figure 9. Forward Bias Safe Operating Area

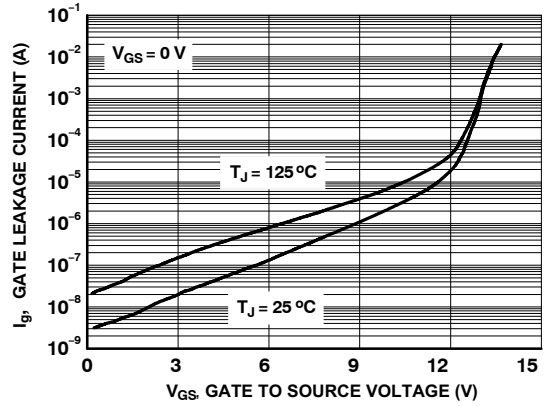

Figure 10. Gate Leakage Current vs. Gate to Source Voltage

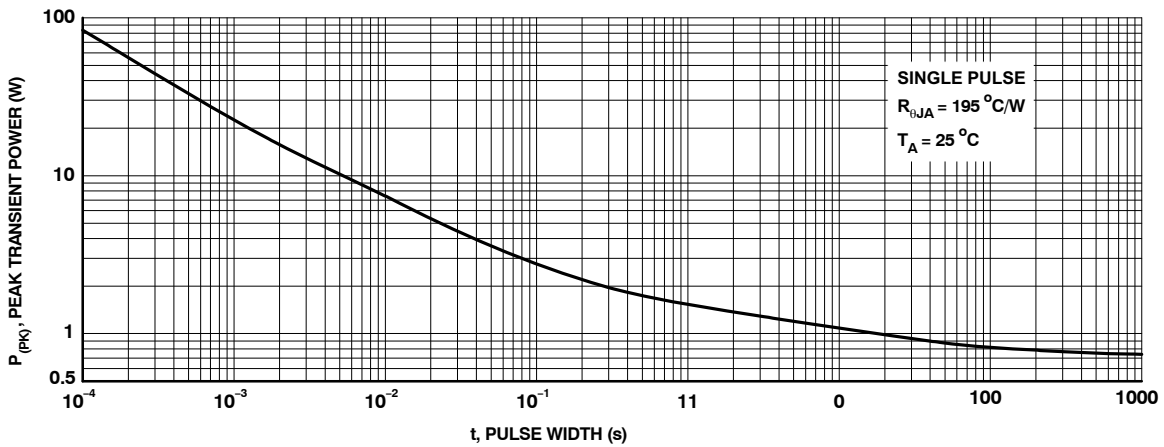

Figure 11. Single Pulse Maximum Power Dissipation

FDME1034CZT

TYPICAL CHARACTERISTICS (Q1 N-CHANNEL) $T_J = 25^\circ\text{C}$ UNLESS OTHERWISE NOTED.

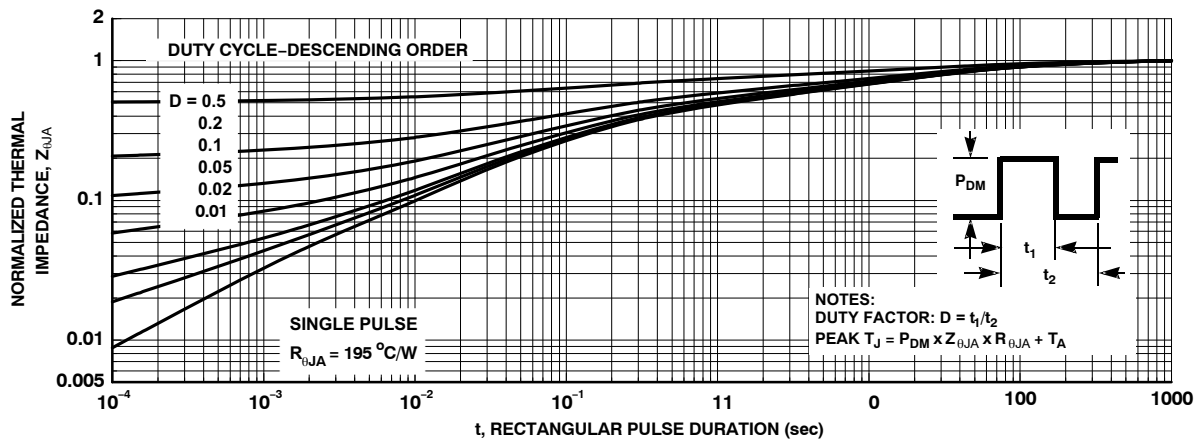

Figure 12. Junction-to-Ambient Transient Thermal Response Curve

FDME1034CZT

TYPICAL CHARACTERISTICS (Q2 P-CHANNEL) $T_J = 25^\circ\text{C}$ UNLESS OTHERWISE NOTED.

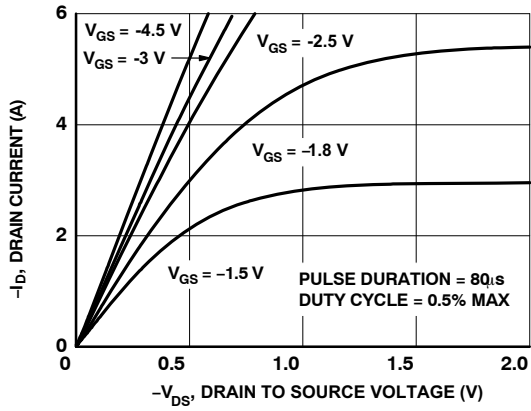

Figure 13. On-Region Characteristics

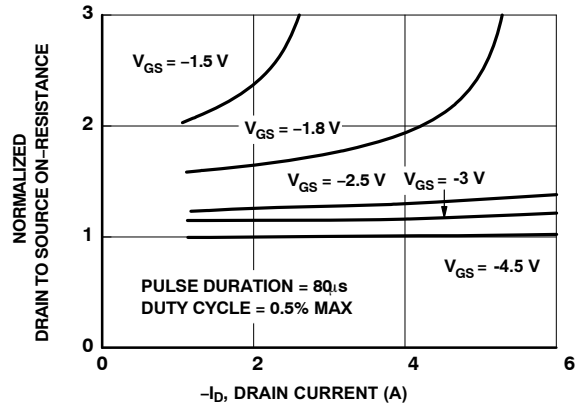

Figure 14. Normalized On-Resistance vs. Drain Current and Gate Voltage

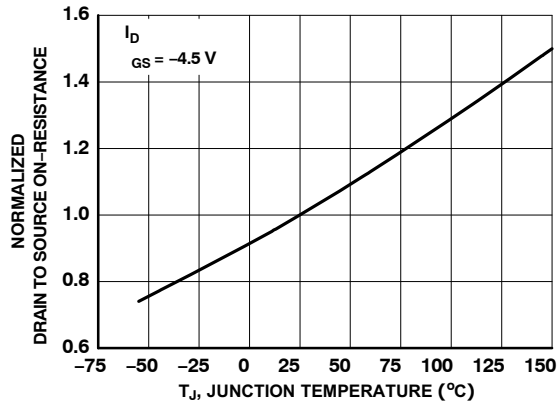

Figure 15. Normalized On-Resistance vs. Junction Temperature

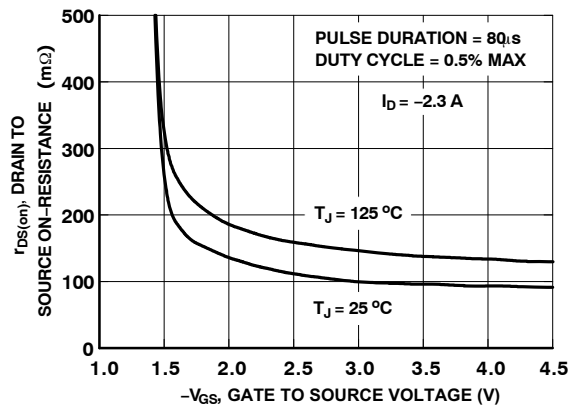

Figure 16. On Resistance vs. Gate to Source Voltage

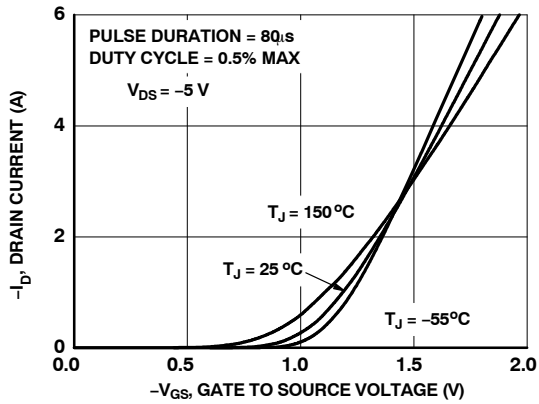

Figure 17. Transfer Characteristics

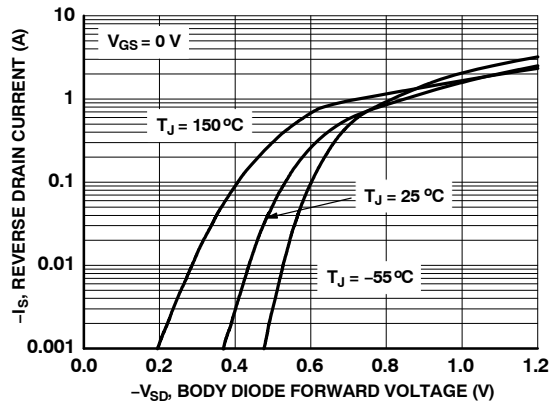

Figure 18. Source to Drain Diode Forward Voltage vs. Source Current

FDME1034CZT

TYPICAL CHARACTERISTICS (Q2 N-CHANNEL) $T_J = 25^\circ\text{C}$ UNLESS OTHERWISE NOTED.

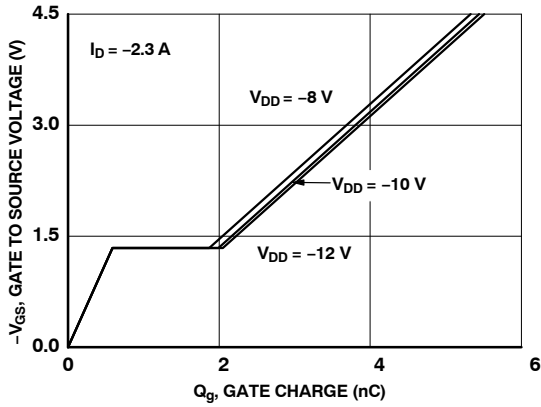

Figure 19. Gate Charge Characteristics

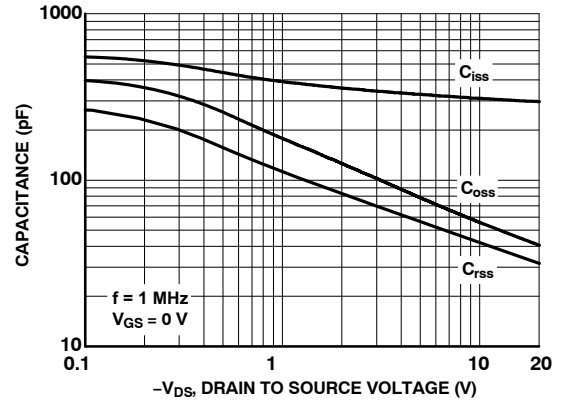

Figure 20. Capacitance vs. Drain to Source Voltage

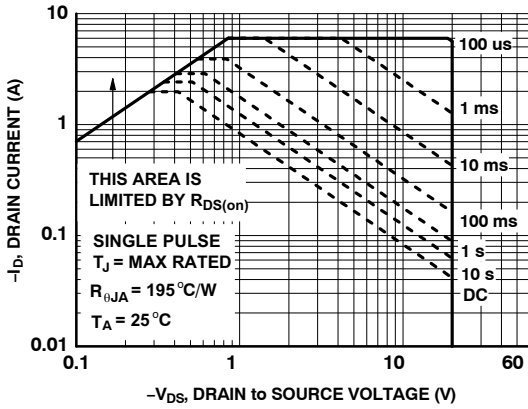

Figure 21. Forward Bias Safe Operating Area

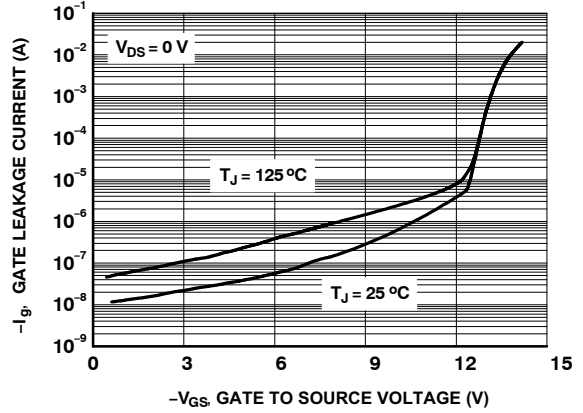

Figure 22. Gate Leakage Current vs. Gate to Source Voltage

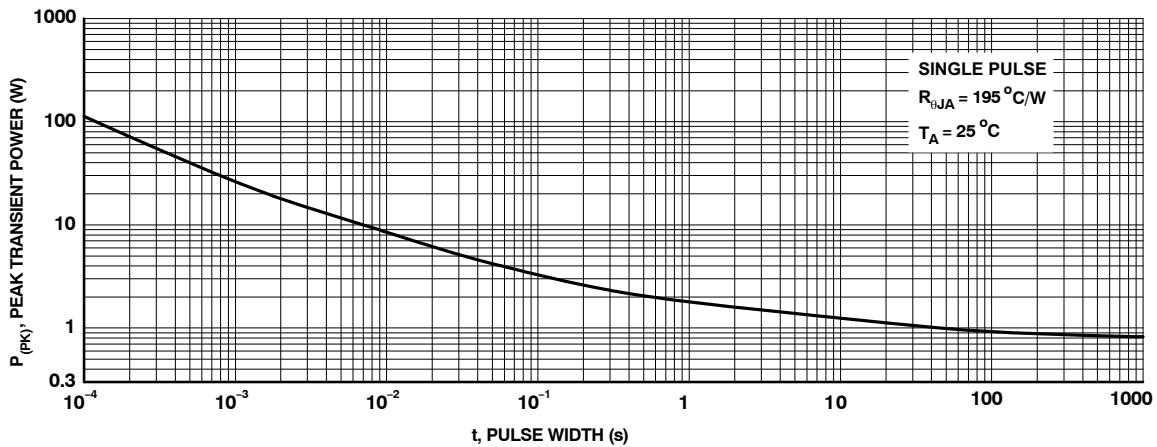

Figure 23. Single Pulse Maximum Power Dissipation

FDME1034CZT

TYPICAL CHARACTERISTICS (Q2 P-CHANNEL) $T_J = 25^\circ\text{C}$ UNLESS OTHERWISE NOTED.

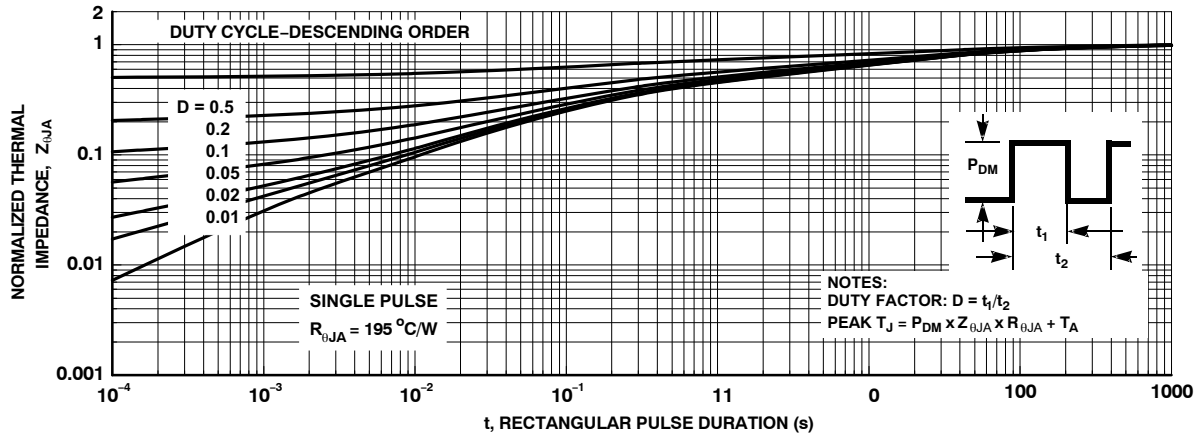

Figure 24. Junction-to-Ambient Transient Thermal Response Curve

POWERTRENCH is a registered trademark and MicroFET is a trademark of Semiconductor Components Industries, LLC dba "onsemi" or its affiliates and/or subsidiaries in the United States and/or other countries.



UDFN6 1.6x1.6, 0.5P
CASE 517DW
ISSUE O

DATE 31 OCT 2016

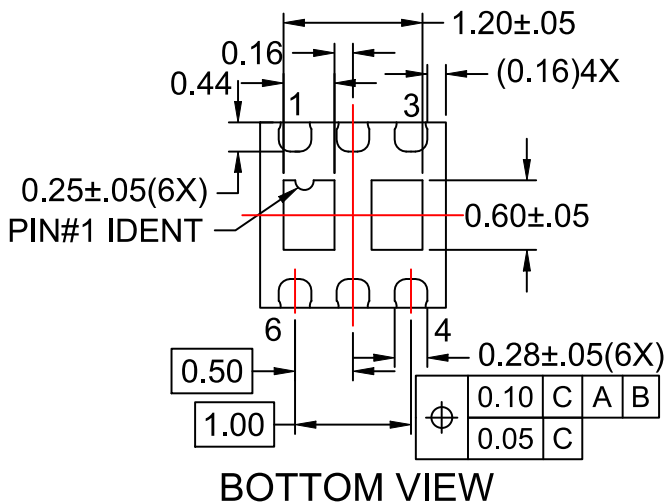
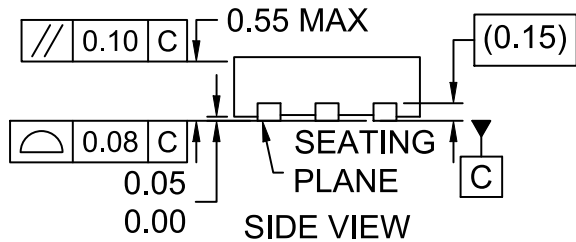
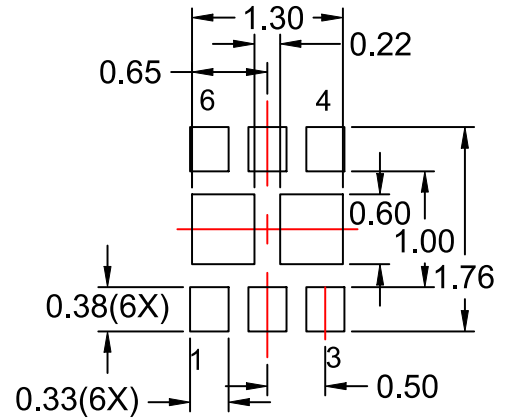
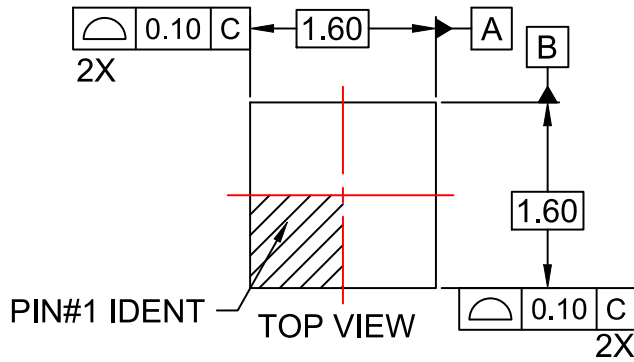

NOTES:

- A. PACKAGE DOES NOT CONFORM TO ANY JEDEC STANDARD.
- B. DIMENSIONS ARE IN MILLIMETERS.
- C. DIMENSIONS AND TOLERANCES PER ASME Y14.5M, 2009.
- D. LAND PATTERN RECOMMENDATION IS EXISTING INDUSTRY LAND PATTERN.

DOCUMENT NUMBER:	98AON13701G	Electronic versions are uncontrolled except when accessed directly from the Document Repository. Printed versions are uncontrolled except when stamped "CONTROLLED COPY" in red.
DESCRIPTION:	UDFN6 1.6x1.6, 0.5P	PAGE 1 OF 1

ON Semiconductor and are trademarks of Semiconductor Components Industries, LLC dba ON Semiconductor or its subsidiaries in the United States and/or other countries. ON Semiconductor reserves the right to make changes without further notice to any products herein. ON Semiconductor makes no warranty, representation or guarantee regarding the suitability of its products for any particular purpose, nor does ON Semiconductor assume any liability arising out of the application or use of any product or circuit, and specifically disclaims any and all liability, including without limitation special, consequential or incidental damages. ON Semiconductor does not convey any license under its patent rights nor the rights of others.

onsemi, **Onsemi**, and other names, marks, and brands are registered and/or common law trademarks of Semiconductor Components Industries, LLC dba "**onsemi**" or its affiliates and/or subsidiaries in the United States and/or other countries. **onsemi** owns the rights to a number of patents, trademarks, copyrights, trade secrets, and other intellectual property. A listing of **onsemi**'s product/patent coverage may be accessed at www.onsemi.com/site/pdf/Patent-Marking.pdf. **onsemi** reserves the right to make changes at any time to any products or information herein, without notice. The information herein is provided "as-is" and **onsemi** makes no warranty, representation or guarantee regarding the accuracy of the information, product features, availability, functionality, or suitability of its products for any particular purpose, nor does **onsemi** assume any liability arising out of the application or use of any product or circuit, and specifically disclaims any and all liability, including without limitation special, consequential or incidental damages. Buyer is responsible for its products and applications using **onsemi** products, including compliance with all laws, regulations and safety requirements or standards, regardless of any support or applications information provided by **onsemi**. "Typical" parameters which may be provided in **onsemi** data sheets and/or specifications can and do vary in different applications and actual performance may vary over time. All operating parameters, including "Typicals" must be validated for each customer application by customer's technical experts. **onsemi** does not convey any license under any of its intellectual property rights nor the rights of others. **onsemi** products are not designed, intended, or authorized for use as a critical component in life support systems or any FDA Class 3 medical devices or medical devices with a same or similar classification in a foreign jurisdiction or any devices intended for implantation in the human body. Should Buyer purchase or use **onsemi** products for any such unintended or unauthorized application, Buyer shall indemnify and hold **onsemi** and its officers, employees, subsidiaries, affiliates, and distributors harmless against all claims, costs, damages, and expenses, and reasonable attorney fees arising out of, directly or indirectly, any claim of personal injury or death associated with such unintended or unauthorized use, even if such claim alleges that **onsemi** was negligent regarding the design or manufacture of the part. **onsemi** is an Equal Opportunity/Affirmative Action Employer. This literature is subject to all applicable copyright laws and is not for resale in any manner.

ADDITIONAL INFORMATION

TECHNICAL PUBLICATIONS:

Technical Library: www.onsemi.com/design/resources/technical-documentation
onsemi Website: www.onsemi.com

ONLINE SUPPORT: www.onsemi.com/support

For additional information, please contact your local Sales Representative at www.onsemi.com/support/sales