

EVAL-IKA15N65ET6 User Guide

About this document

Scope and purpose

This user guide provides an overview of the evaluation board EVAL-IKA15N65ET6 including main features, key data, pin assignments, and mechanical dimensions.

EVAL-IKA15N65ET6 was developed to support customers in their first steps designing applications for permanent magnet synchronous motors (PMSM) or brushless DC machines e.g. pumps, fans, washing machines, general purposes drives, and power tools up to 1.2 kW.

The board is fully equipped with all assembly groups required to achieve sensor-less or sensor-based, field oriented control (FOC). To this end, various Infineon product families have been utilized, such as TRENCHSTOP™ 5 IGBT in power factor correction (PFC) circuit together with a Rapid 1 silicon power diode, TRENCHSTOP™ IGBT6 in inverter stage, iMOTION™ driver to control both PFC and inverter stage, XENSIV™ — high-precision coreless current sensor to sense the current, and CoolSET™ in auxiliary power supplies.

Intended audience

This user guide is intended for all technical specialists who have a good knowledge of motor control and high-power electronic converters. The board must only be used under laboratory conditions.

Evaluation board

The board is to be used during the design-in process for evaluating and measuring characteristic curves, and for checking datasheet specifications.

Note: Printed Circuit Board and auxiliary circuits are NOT optimized for final customer design.



EVAL-IKA15N65ET6 User Guide

Important notice

Important notice

“Evaluation Boards and Reference Boards” shall mean products embedded on a printed circuit board (PCB) for demonstration and/or evaluation purposes, which include, without limitation, demonstration, reference and evaluation boards, kits and design (collectively referred to as “Reference Board”).

Environmental conditions have been considered in the design of the Evaluation Boards and Reference Boards provided by Infineon Technologies. The design of the Evaluation Boards and Reference Boards has been tested by Infineon Technologies only as described in this document. The design is not qualified in terms of safety requirements, manufacturing and operation over the entire operating temperature range or lifetime.

The Evaluation Boards and Reference Boards provided by Infineon Technologies are subject to functional testing only under typical load conditions. Evaluation Boards and Reference Boards are not subject to the same procedures as regular products regarding returned material analysis (RMA), process change notification (PCN) and product discontinuation (PD).

Evaluation Boards and Reference Boards are not commercialized products, and are solely intended for evaluation and testing purposes. In particular, they shall not be used for reliability testing or production. The Evaluation Boards and Reference Boards may therefore not comply with CE or similar standards (including but not limited to the EMC Directive 2004/EC/108 and the EMC Act) and may not fulfill other requirements of the country in which they are operated by the customer. The customer shall ensure that all Evaluation Boards and Reference Boards will be handled in a way which is compliant with the relevant requirements and standards of the country in which they are operated.

The Evaluation Boards and Reference Boards as well as the information provided in this document are addressed only to qualified and skilled technical staff, for laboratory usage, and shall be used and managed according to the terms and conditions set forth in this document and in other related documentation supplied with the respective Evaluation Board or Reference Board.

It is the responsibility of the customer’s technical departments to evaluate the suitability of the Evaluation Boards and Reference Boards for the intended application, and to evaluate the completeness and correctness of the information provided in this document with respect to such application.

The customer is obliged to ensure that the use of the Evaluation Boards and Reference Boards does not cause any harm to persons or third-party property.

The Evaluation Boards and Reference Boards and any information in this document is provided "as is" and Infineon Technologies disclaims any warranties, express or implied, including but not limited to warranties of non-infringement of third-party rights and implied warranties of fitness for any purpose, or for merchantability.

Infineon Technologies shall not be responsible for any damages resulting from the use of the Evaluation Boards and Reference Boards and/or from any information provided in this document. The customer is obliged to defend, indemnify and hold Infineon Technologies harmless from and against any claims or damages arising out of or resulting from any use thereof.

Infineon Technologies reserves the right to modify this document and/or any information provided herein at any time without further notice.

EVAL-IKA15N65ET6 User Guide

Safety precautions

Safety precautions

Note: Please note the following warnings regarding the hazards associated with development systems.

Table 1 Safety precautions

	<p>Warning: The DC link potential of this board is up to 1000 VDC. When measuring voltage waveforms by oscilloscope, high voltage differential probes must be used. Failure to do so may result in personal injury or death.</p>
	<p>Warning: The evaluation or reference board contains DC bus capacitors which take time to discharge after removal of the main supply. Before working on the drive system, wait five minutes for capacitors to discharge to safe voltage levels. Failure to do so may result in personal injury or death. Darkened display LEDs are not an indication that capacitors have discharged to safe voltage levels.</p>
	<p>Warning: The evaluation or reference board is connected to the grid input during testing. Hence, high-voltage differential probes must be used when measuring voltage waveforms by oscilloscope. Failure to do so may result in personal injury or death. Darkened display LEDs are not an indication that capacitors have discharged to safe voltage levels.</p>
	<p>Warning: Remove or disconnect power from the drive before you disconnect or reconnect wires, or perform maintenance work. Wait five minutes after removing power to discharge the bus capacitors. Do not attempt to service the drive until the bus capacitors have discharged to zero. Failure to do so may result in personal injury or death.</p>
	<p>Caution: The heat sink and device surfaces of the evaluation or reference board may become hot during testing. Hence, necessary precautions are required while handling the board. Failure to comply may cause injury.</p>
	<p>Caution: Only personnel familiar with the drive, power electronics and associated machinery should plan, install, commission and subsequently service the system. Failure to comply may result in personal injury and/or equipment damage.</p>
	<p>Caution: The evaluation or reference board contains parts and assemblies sensitive to electrostatic discharge (ESD). Electrostatic control precautions are required when installing, testing, servicing or repairing the assembly. Component damage may result if ESD control procedures are not followed. If you are not familiar with electrostatic control procedures, refer to the applicable ESD protection handbooks and guidelines.</p>
	<p>Caution: A drive that is incorrectly applied or installed can lead to component damage or reduction in product lifetime. Wiring or application errors such as undersizing the motor, supplying an incorrect or inadequate AC supply, or excessive ambient temperatures may result in system malfunction.</p>
	<p>Caution: The evaluation or reference board is shipped with packing materials that need to be removed prior to installation. Failure to remove all packing materials that are unnecessary for system installation may result in overheating or abnormal operating conditions.</p>

Table of contents

About this document.....	1
Important notice	2
Safety precautions.....	3
Table of contents.....	4
1 The board at a glance.....	5
1.1 Scope of supply	5
1.2 Block diagram.....	7
2 Main features.....	8
2.1 EVAL-IKA15N65ET6 board specifications	8
2.2 Pin assignment	9
3 Getting started	11
3.1 Setting up the system.....	11
3.2 iMOTION™ development and software tools	12
3.2.1 MCEWizard setup overview.....	12
3.2.2 MCEDesigner setup overview	15
3.2.3 Firmware version update.....	17
3.2.4 Hall sensor TLI4971 programming	18
4 Hardware description	20
4.1 Motor controller	20
4.2 PFC stage	20
4.3 Current sensing	21
4.4 Power stage	21
4.5 Auxiliary power supply	22
4.6 PCB layout of EVAL-IKA15N65ET6.....	23
5 Bill of material	25
6 System performance - evaluation results.....	33
6.1 Auxiliary power supply test.....	33
6.2 PFC test.....	33
6.3 Inverter test	41
6.4 dv/dt test	42
6.5 Protection test.....	44
6.5.1 Inverter short-circuit/overcurrent protection.....	44
6.5.2 PFC overcurrent protection	45
6.6 Negative temperature coefficient (NTC) thermistor characterization test.....	46
Revision history.....	47
Disclaimer.....	48

1 The board at a glance

The evaluation board EVAL-IKA15N65ET6 is intended to control 3-phase motors plus the PFC stage. It includes an electromagnetic interference (EMI) filter, a soft power-up circuit, an 8-pin control interface connector, a motor controller, a PFC gate drive circuit, an auxiliary power supply, discrete modules, and a 3-phase output for connecting the motor.

The evaluation board is equipped with the latest components from the iMOTION™, TRENCHSTOP™, CoolSET™, and XENSIV™ product families (see also Chapter 4). In particular:

- The iMOTION™ IMD112T-6F040 smart driver is utilized for motor and PFC control. It includes a high voltage, 3-phase gate driver and voltage regulator. It is able to drive a wide variety of MOSFETs or IGBTs
- The TRENCHSTOP™ 5 IGBT IKWH30N65WR6 and the Rapid 1 power silicon diode IDW30E65D1 perform the boost PFC stage. Additionally, the TRENCHSTOP™ 5 WR6 family of discrete devices offers lowest losses, and enables a more reliable system design with increased creepage and clearance distances
- TRENCHSTOP™ IGBT6 IKA15N65ET6 implements the 3-phase, 2-level inverter. The TRENCHSTOP™ IGBT6 portfolio targets major home appliance (MHA) drive applications from low to high power
- The XENSIV™ TLI4971 Hall sensor is used for PFC and inverter current sensing. This coreless magnetic current sensor solution can be used for AC and DC measurements
- The latest CoolSET™ 5th generation flyback controller with integrated MOSFET, specifically ICE5GR4780AG, is used to generate the required auxiliary power supply voltages

The board described here can be operated directly without the need of additional hardware components. A set of personal computer (PC) software tools is required to set up the system and to control and fine-tune its performance to match users' needs (see Chapter 3).

EVAL-IKA15N65ET6 is available through regular Infineon distribution partners and from Infineon's website. The features of this board are described in the "Main features" section of Chapter 2. The other chapters provide information on how to copy, modify, and qualify the design for production according to customers' specific requirements.

Environmental conditions were considered in the design, but the board is not qualified in terms of safety requirements, manufacturing, and operation over the entire operating temperature range or lifetime. The boards provided by Infineon are subject to functional testing only.

1.1 Scope of supply

The scope of supply includes the complete EVAL-IKA15N65ET6 evaluation board.

Figure 1 shows the functional groups on the top side of board.

EVAL-IKA15N65ET6 User Guide

The board at a glance

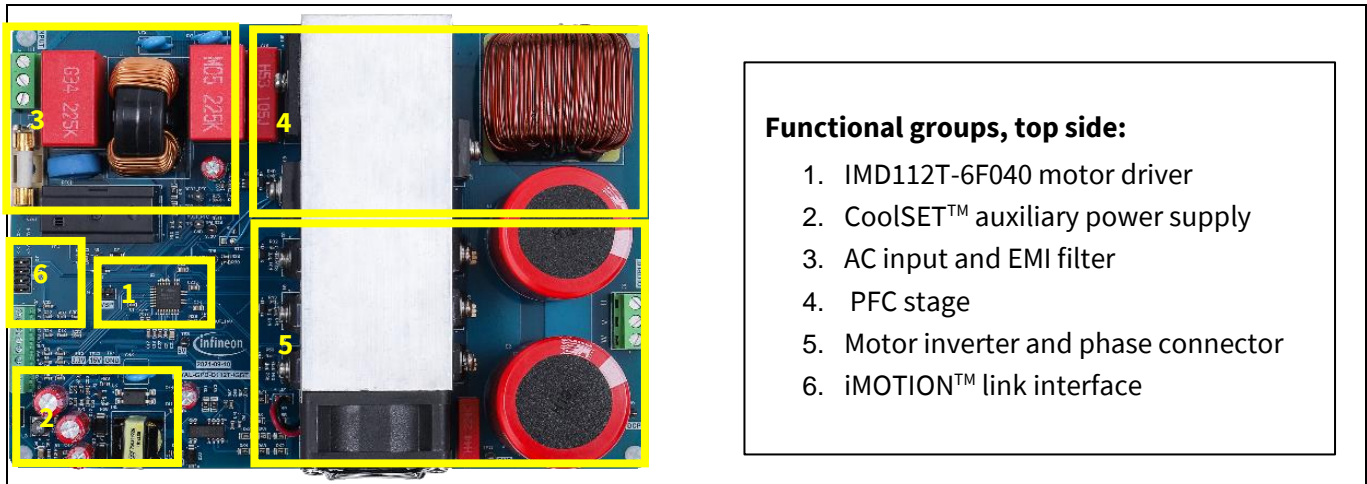

Figure 1 Functional groups of the EVAL-IKA15N65ET6 evaluation board, top side

Figure 2 shows the functional groups on the bottom side of the board.

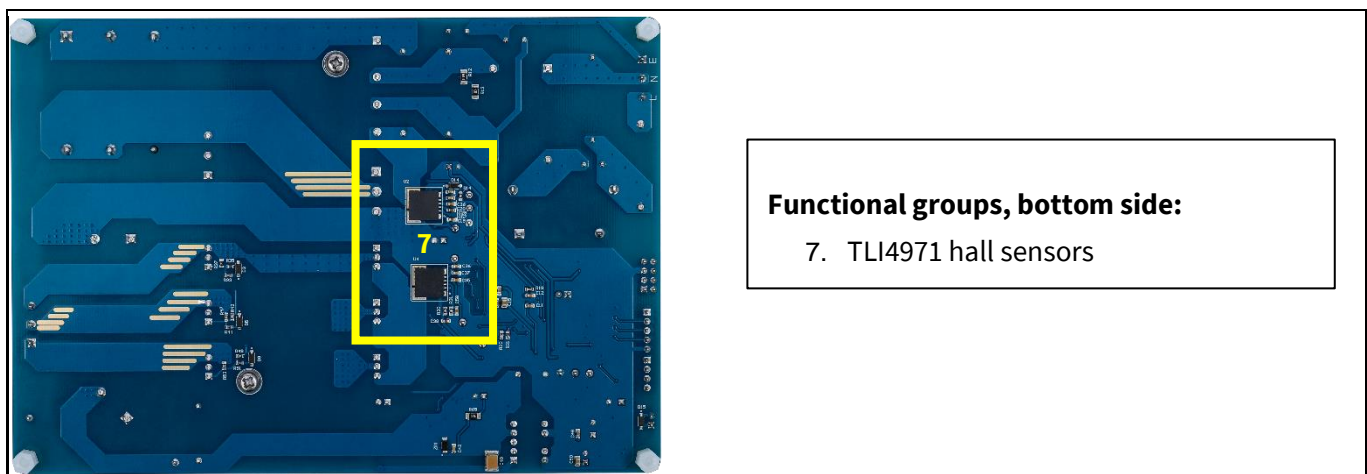

Figure 2 Functional groups of the EVAL-IKA15N65ET6 evaluation board, bottom side

EVAL-IKA15N65ET6 User Guide

The board at a glance

1.2 Block diagram

Figure 3 shows the block diagram of EVAL-IKA15N65ET6.

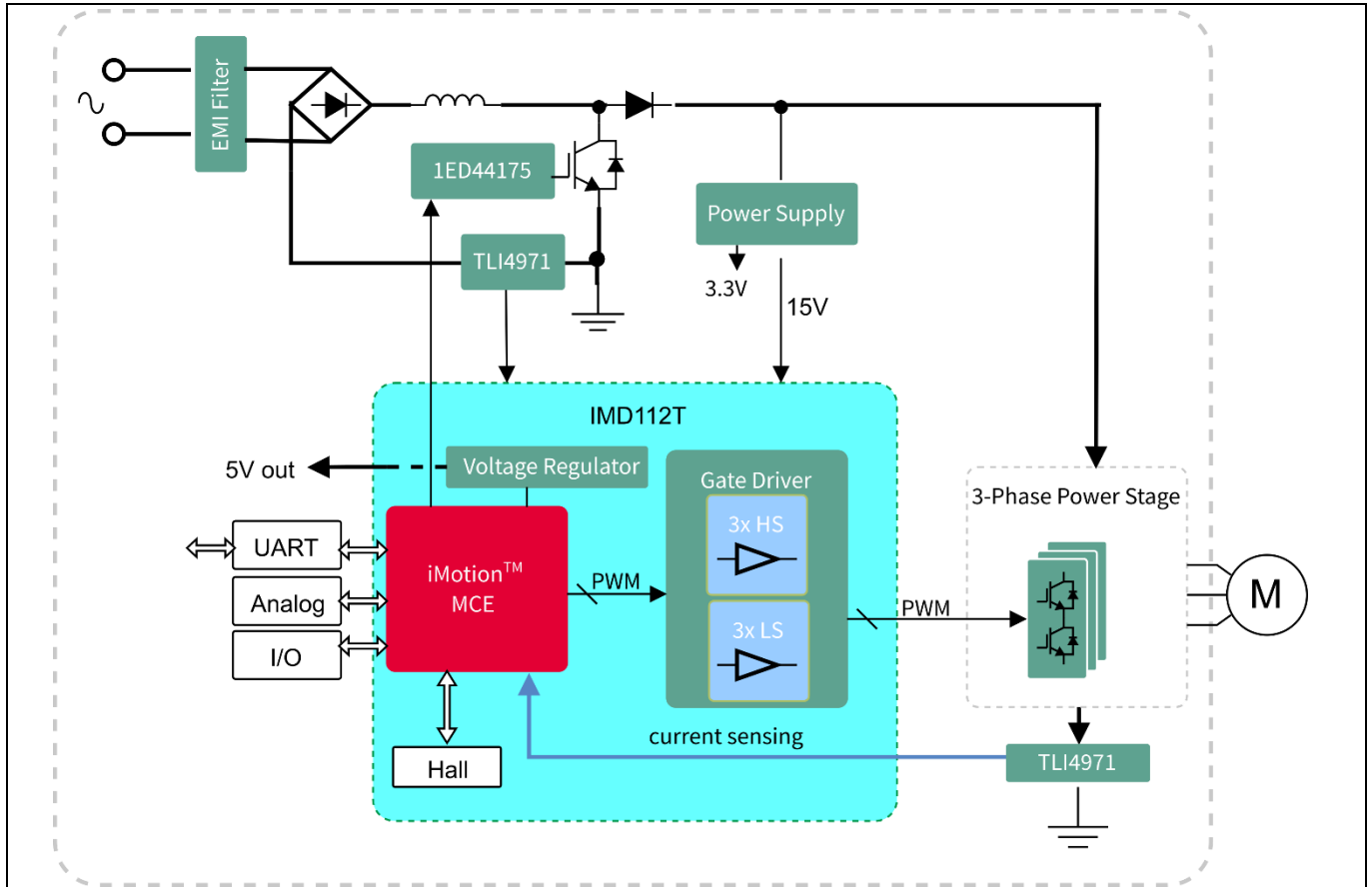

Figure 3 Block diagram of EVAL-IKA15N65ET6

EVAL-IKA15N65ET6 User Guide

Main features

2 Main features

The EVAL-IKA15N65ET6 evaluation board contains the following main features:

- PFC control stage with Rapid 1 IDW30E65D1 and TRENCHSTOP™ 5 IGBT IKWH30N65WR6 in a wide creepage and clearance TO-247 package
- 3-phase, 2-level inverter with TRENCHSTOP™ IGBT6 IKA15N65ET6 in a TO-220FP package, 15 A, 650 V
- Sensor-based control for both PFC and inverter stages using TLI4971-A025T5-E0001 with analog interface and dual fast overcurrent detection outputs. All negative effects (saturation, hysteresis) commonly known from sensors using flux concentration techniques are avoided
- IMD112T-6F040 driver integrating motor and PFC controller and 600 V, 3-phase gate driver in a LQFP-40 package
- Auxiliary power supply using ICE5GR4780AG—the latest 5th generation fixed frequency CoolSET™ offering high performance and integration of latest generation of 800 V CoolMOS™ P7 super-junction MOSFETs in a DSO-12 package

2.1 Board specifications of EVAL-IKA15N65ET6

Table 1 lists the key specifications of the evaluation board EVAL-IKA15N65ET6.

Table 1 EVAL-IKA15N65ET6 board specifications

Parameters		Values	Conditions/comments
Input			
Voltage		$V_{in} = 165 \sim 265 V_{ac}$ (designed) $V_{in} = 120 V_{ac}$ - USA grid voltage (rectified without PFC stage – not designed and no guarantee of given specifications)	<ul style="list-style-type: none"> • Typical pulse width modulation (PWM) setup for 40 kHz PFC and 6-16 kHz motor operation, 3-phase-only mode, motor speed: maximum 2500 rpm for GK6063 motor • PFC control parameters: $K_{pI} = 2800$, $K_{xI} = 9000$, $K_{pV} = 1000$, $K_{xV} = 50$
	Switching frequency		
	$f_{PFC} = 40 \text{ kHz}$		
		$f_{PWM} = 6 \text{ kHz}$ (Inverter)	$f_{PWM} = 16 \text{ kHz}$ (Inverter)
Current	3.64 A _{rms}	Input 165 V _{AC} (enabled PFC function), pin = 593 W, T _a = 22.1°C, motor speed = 2500 rpm	
	7.36 A _{rms}	Input 165 V _{AC} (enabled PFC function), pin = 1215 W, T _a = 22.3°C, motor speed = 2500 rpm	
	2.84 A _{rms}	Input 220 V _{AC} (enabled PFC function), pin = 597 W, T _a = 19.3°C, motor speed = 2500 rpm	Input 220 V _{AC} (enabled PFC function), pin = 576 W, T _a = 29.3°C, motor speed = 2500 rpm

EVAL-IKA15N65ET6 User Guide

Main features

	5.56 A _{rms}	Input 220 V _{AC} (enabled PFC function), pin = 1202 W, T _a = 19.8°C, motor speed = 2500 rpm	Input 220 V _{AC} (enabled PFC function), pin = 1185 W, T _a = 27.9°C, motor speed = 2500 rpm
	2.36 A _{rms}	Input 265 V _{AC} (enabled PFC function), pin = 588 W, f _{PWM} = 6 kHz, f _{PFC} = 40 kHz, T _a = 21.6°C, motor speed = 2500 rpm	
	4.70 A _{rms}	Input 265 V _{AC} (enabled PFC function), pin = 588 W, T _a = 22.6°C, motor speed = 2500 rpm	
Output			
Power (three phases)	1200 W	165 V _{AC} ≤ input ≤ 265 V _{AC} (enabled PFC function), f _{PWM} = 6–16 kHz, f _{PFC} = 40 kHz, motor speed = 2500 rpm	
Current per leg	5 A _{rms}	Input = 165 AC (enabled PFC function), P _{out} = 1200 W, f _{PWM} = 6–16 kHz, f _{PFC} = 40 kHz, motor speed = 2500 rpm	
DC bus voltage			
Recommended DC bus voltage	375 V		
Protections			
Inverter short circuit protection/Over Current Protection	Via iMOTION™		
PFC Overcurrent protection	Via TLI4971		
Onboard power supply			
15 V	15 V ± 1 V		
3.3 V	3.3 V ± 5%		
5 V	5 V ± 5%		
PCB characteristics			
Material	FR4		
Dimension	178 mm x 125 mm		
System environment			
Ambient temperature	25°C	Tested at ambient temperature	

2.2 Pin assignment

The EVAL-IKA15N65ET6 evaluation board provides an AC input connector and a 3-phase output for connecting the motor.

Table 2 lists the details of the AC input connector J1.

Table 2 J1- AC line connector

No.	Pin	Details

EVAL-IKA15N65ET6 User Guide

Main features

1	Line	AC line input
2	Neutral	AC neutral input
3	Earth	Earth ground

Table 3 lists the details of the motor side connector J2.

Table 3 J2- Motor side connector

No.	Pin	Details
1	W	Connected to motor phase W
2	V	Connected to motor phase V
3	U	Connected to motor phase U

3 Getting started

To run a motor system with the EVAL-IKA15N65ET6 evaluation board, the iMOTION™ PC software tools—MCEDesigner and MCEWizard—are required to set up the system and to control and fine-tune the system's performance to meet user requirements. This chapter provides information on how to set up the system and get started with the EVAL-IKA15N65ET6 evaluation board.

Note: The Hall sensor TLI4971-A025T5-E0001 is used as a current sensing element for the PFC and inverter stage. At delivery of the evaluation board, the Hall sensors are pre-programmed to the 25 A measurement range. These default settings are described in detail in the datasheet of the current sensor. The evaluation board was tested using the firmware version IMD112T-F040_A_V1.03.03.Idf.

3.1 Setting up the system

After downloading and installing the iMOTION™ PC tools —MCEWizard and MCEDesigner—the following steps must be taken to operate the motor:

1. Download “IMD112T-6F040 MCE Software Package V1.3.3” from www.infineon.com/imotion-software.
2. Connect the PC to the iMOTION™ Link via a USB cable and to the evaluation board via the isolated 8-pin iMOTION™ debug connector.
3. Connect the AC source and target motor.
4. Use MCEWizard to calculate and create a parameter text file. See Section 3.2.1 on MCEWizard setup for more details.
5. Power on the system and start the MCEDesigner tool to open the MCEDesigner default configuration file (.irc) for IMD112T-6F040 smart driver.
6. Program the parameter file created in the previous step together with firmware file that needs to be programmed once. See Section 3.2.2 for an overview of the MCEDesigner setup for more details. The firmware version V1.03.03 has been programmed into the flash of IMD112T-6F040.
7. After successful programming, click the hammer icon to clear the fault signals if there is a red light at the bottom of MCEDesigner. When the system is ready, start the motor by clicking the green traffic light. Clicking the red traffic light will stop the motor.

Refer to Sections 3.2.1, 3.2.2, and the MCEWizard and MCEDesigner user guides for additional information.

Figure 4 shows the system connections using EVAL-IKA15N65ET6.

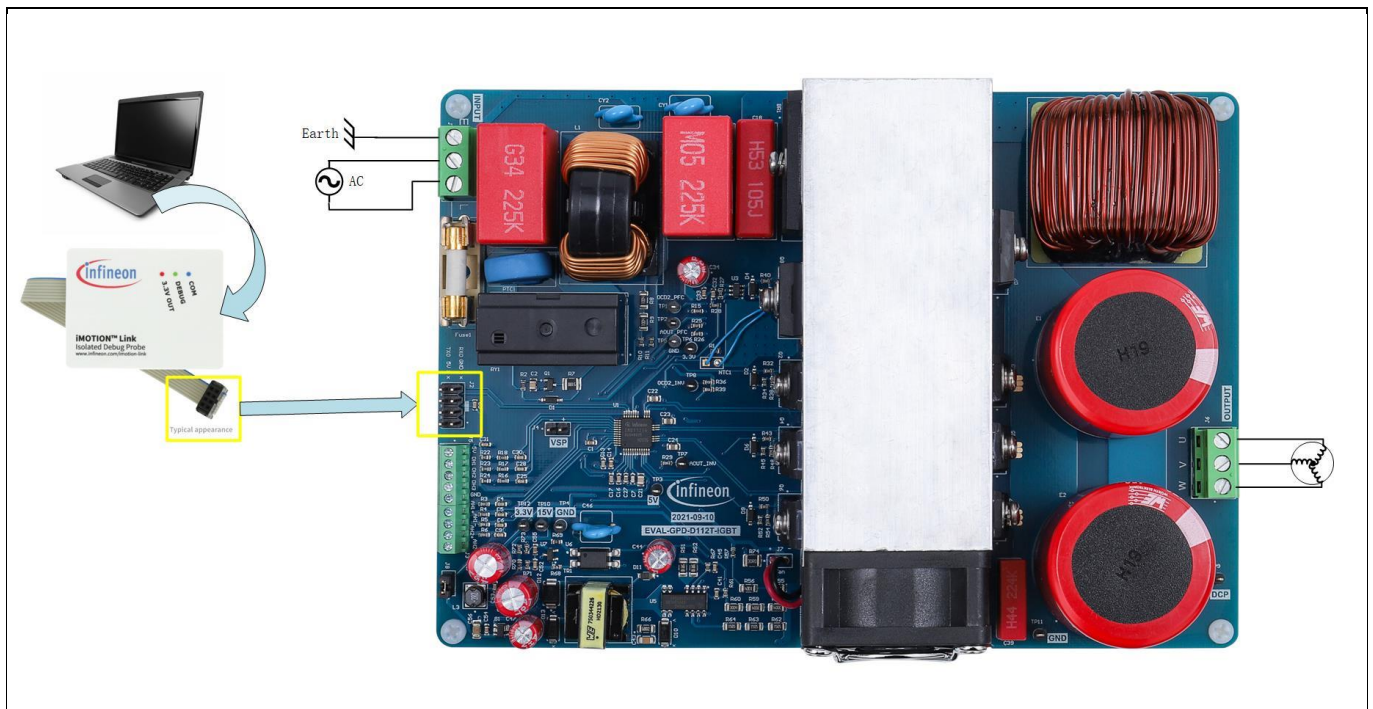

Figure 4 System connections using EVAL-IKA15N65ET6

3.2 iMOTION™ development and software tools

The iMOTION™ development tools—MCEDesigner and MCEWizard—can be downloaded from Infineon’s iMOTION™ website (<http://www.infineon.com/imotion-software>). All available tools and software versions are listed there.

The iMOTION™ Link debug probe is an essential tool for configuring, parameterizing, and programming the IMD112T-6F040 that is not included in the scope of delivery. Users should order the iMOTION™ Link if they do not already have one. Ordering information can be found at [iMotion™-Link](#).

Note: Please note that the iMOTION™ development tools described here are based on version V2.3.0.1. Some features may vary according to different versions. Please refer to the relevant version of the MCEWizard or MCEDesigner user guides.

3.2.1 MCEWizard setup overview

MCEWizard defines the control gains, limits, and fault levels based on real number inputs and converts the gains and levels to parameter counts based on hardware and control limit settings. MCEWizard also exports parameters and variable scale factors to the MCEDesigner.

To open the setup overview, double-click the MCEWizard shortcut on the Windows desktop. The MCEWizard welcome page is shown in Figure 5.

If users have the evaluation design kit “MCEWizard configuration file,” they need only to click **Open System Configuration File** and change the user motor parameters under test.

If users do not have the MCEWizard configuration file, they need to follow these steps:

1. Click on **File** and select **Create System Configuration File**.
2. Select the IMD112T device from the pop-up window.

EVAL-IKA15N65ET6 User Guide

Getting started

3. Click **OK** and return to the Welcome Page.
4. Select **Customized Design for Expert User**.
5. Click on **Next** to answer questions concerning hardware design and user test motor specifications.

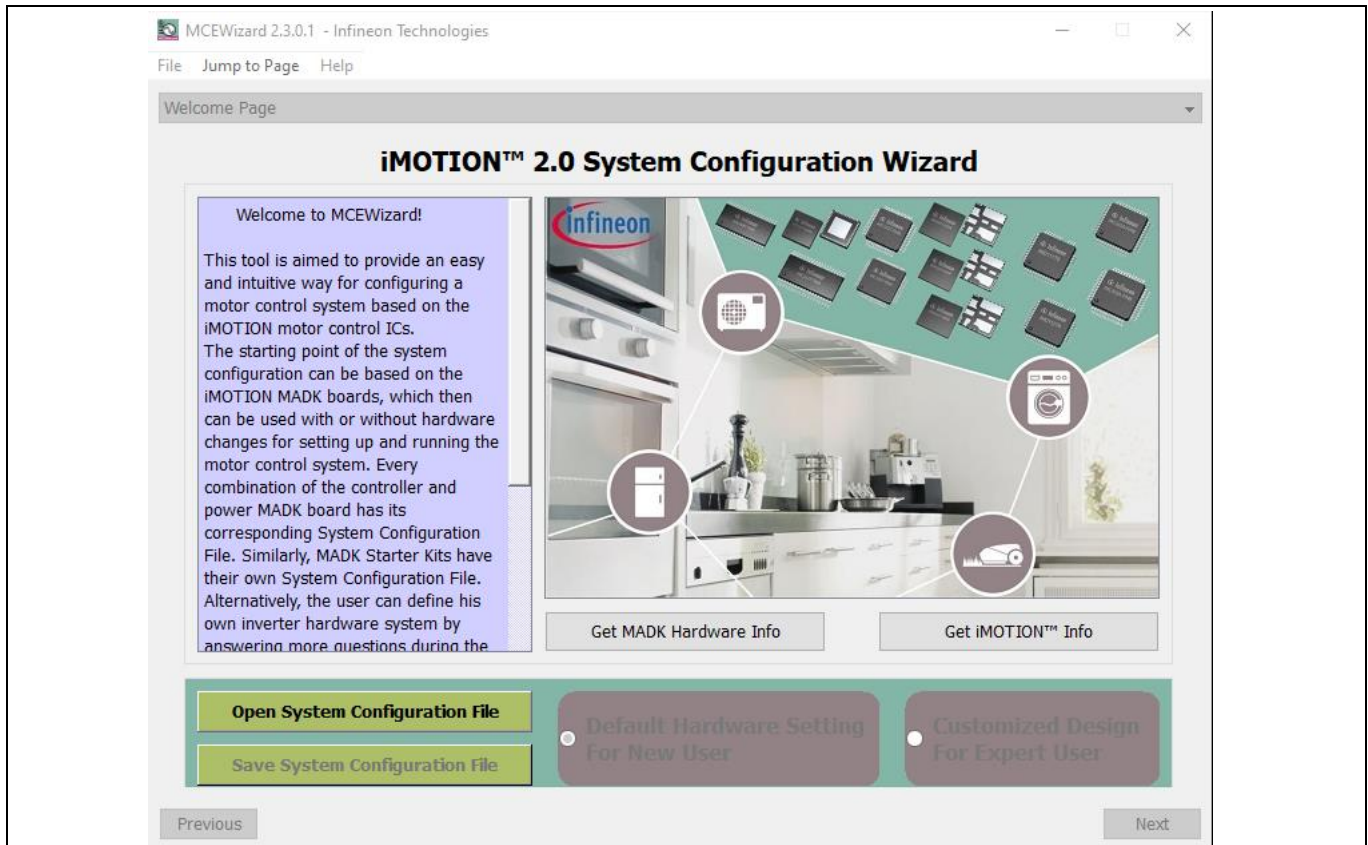

Figure 5 Welcome page of MCEWizard

The iMOTION™ PC software tools enable users to easily test their motors. Users should be familiar with system level parameters that are related to the motor used. There are a limited number of parameters that are specific to the control board or power board hardware. Table 4 provides the MCEWizard setup overview for hardware-related parameters.

Table 4 MCEWizard setup overview table

Page	Parameter	Value	Comment
Welcome Page	Control device selecting	IMD112T	
Options Page	Motor 1 shunt configuration	Single shunt	
Question 2	Motor rated current	7.5 A _{rms}	GK6063-6AC31-FE
Question 3	Motor poles	6	GK6063-6AC31-FE
Question 4	Motor stator resistance	0.6 Ω/phase	GK6063-6AC31-FE
Question 5	Motor L _q inductance	4 mH	GK6063-6AC31-FE
Question 6	Motor L _d inductance	4 mH	GK6063-6AC31-FE
Question 7	Motor back electro-motive-force (EMF) constant (Ke)	45 V (In-rms)/krpm	GK6063-6AC31-FE
Question 8	Motor maximum rpm	2500 rpm	GK6063-6AC31-FE

EVAL-IKA15N65ET6 User Guide

Getting started

Question 16	Target DC bus voltage initialization	380 V	
Question 24	Controller supply voltage	5 V	
Question 46	Maximum DC bus voltage	500 V	
Question 50	DC bus sensing high resistor	2000 k Ω	Depends on the board
Question 51	DC bus sensing low resistor	20 k Ω	Depends on the board
Question 78	Inverter deadtime	~1 μ s	Programmable
Question 80	GateSense low-side devices	High is true	
Question 81	GateSense high-side devices	High is true	
Question 83	Current feedback and sample timing	48 mV/A	Depends on the TLI4971 setting
Question 84	Internal current feedback amplifier gain	1	Programmable
Question 93	Overcurrent trip level for internal GateKill comparator	15.5 A	For EVAL-IKA15N65ET6 only
Question 107	PFC topology	Boost PFC	
Question 109	PFC inductance	0.5 mH	For EVAL-IKA15N65ET6 only
Question 110	PFC current measurement input scaling	348 mV/A	Depends on the TLI4971 setting
Question 114	AC voltage sensing high resistor	2000 k Ω	Power board parts
Question 115	AC voltage sensing low resistor	20 k Ω	
Question 117	PFC gate driver polarity low side	High is active	
Question 118	PFC current sample delay time	1.5 μ s	Depends on SNR and switching noise

When all MCEWizard questions have been answered, the Verify & Save Page appears as shown in Figure 6.

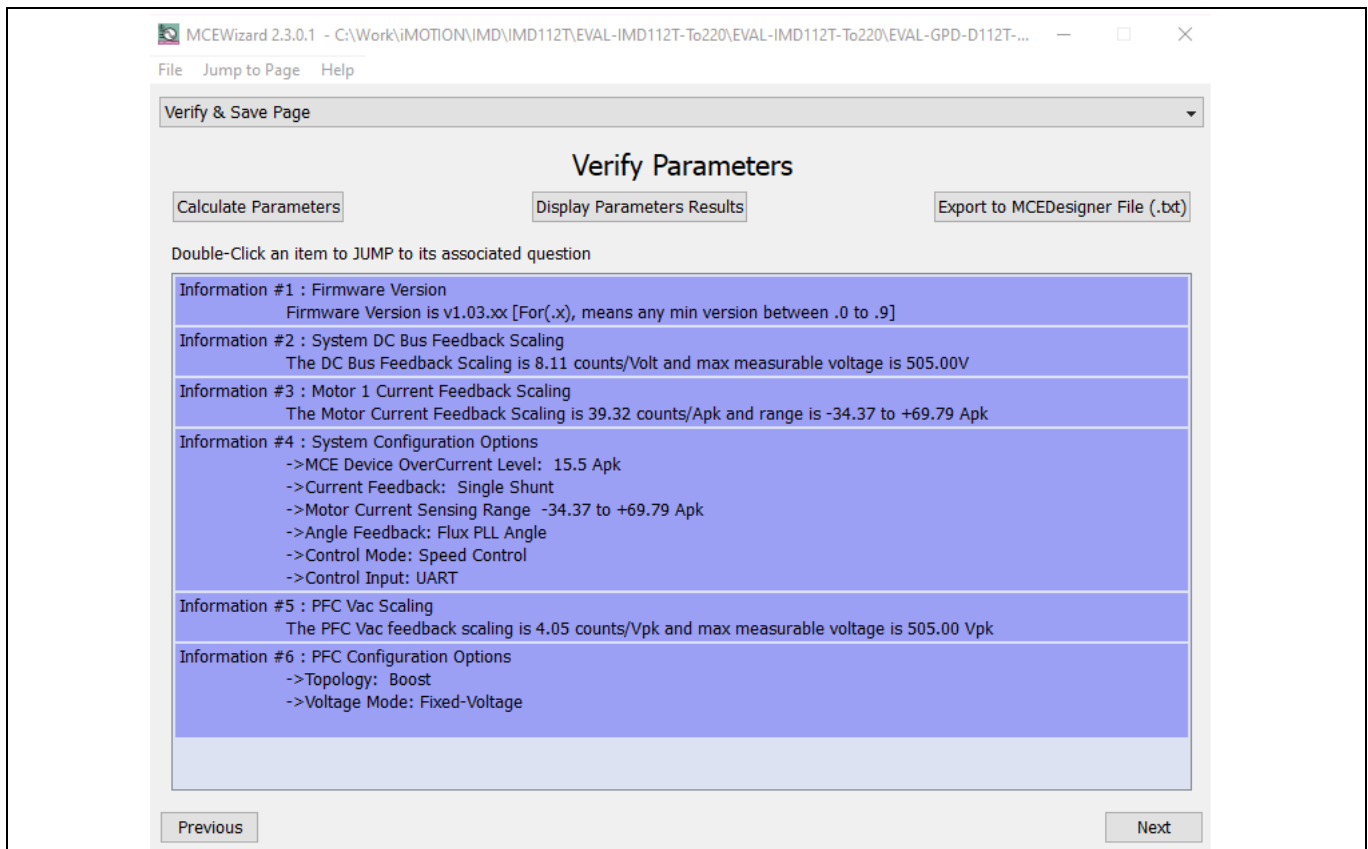

Figure 6 Verify & Save Page in MCEWizard

Click **Calculate Parameters** and then click **Export to MCEDesigner File (.txt)** to save the parameter file. It will be subsequently used in the MCEDesigner.

3.2.2 MCEDesigner setup overview

MCEDesigner is a graphical user interface (GUI) tool used for programming the code and tuning the evaluation board. It can read from 16-bit motion control engine (MCE) variable registers and read/write from and to MCE parameter registers. MCEDesigner displays both real and count values for all variable registers, and selects parameter registers. The count value is the conversion of the real value to a digital number. The register value format can be selected from the **Performance > Tuning Value Format** pop-up window.

After installing the MCEDesigner installer, a shortcut button appears on the Windows Desktop to quick start the MCEDesigner, as follows:

1. Double-click the shortcut to open the MCEDesigner.
2. Open the MCEDesigner default configuration file (.irc) for IMD112T smart driver (IMD112T_V1.03.03.irc) included in the firmware zip folder that was downloaded from Infineon's website.
3. The controller's power supply should be selected either 3.3 V or 5 V in MCEWizard. Then select the available COM port in **Performance > Connection** pop-up window. Once connected the communication port will turn green.

The MCEDesigner window appears, as shown in Figure 7.

EVAL-IKA15N65ET6 User Guide

Getting started

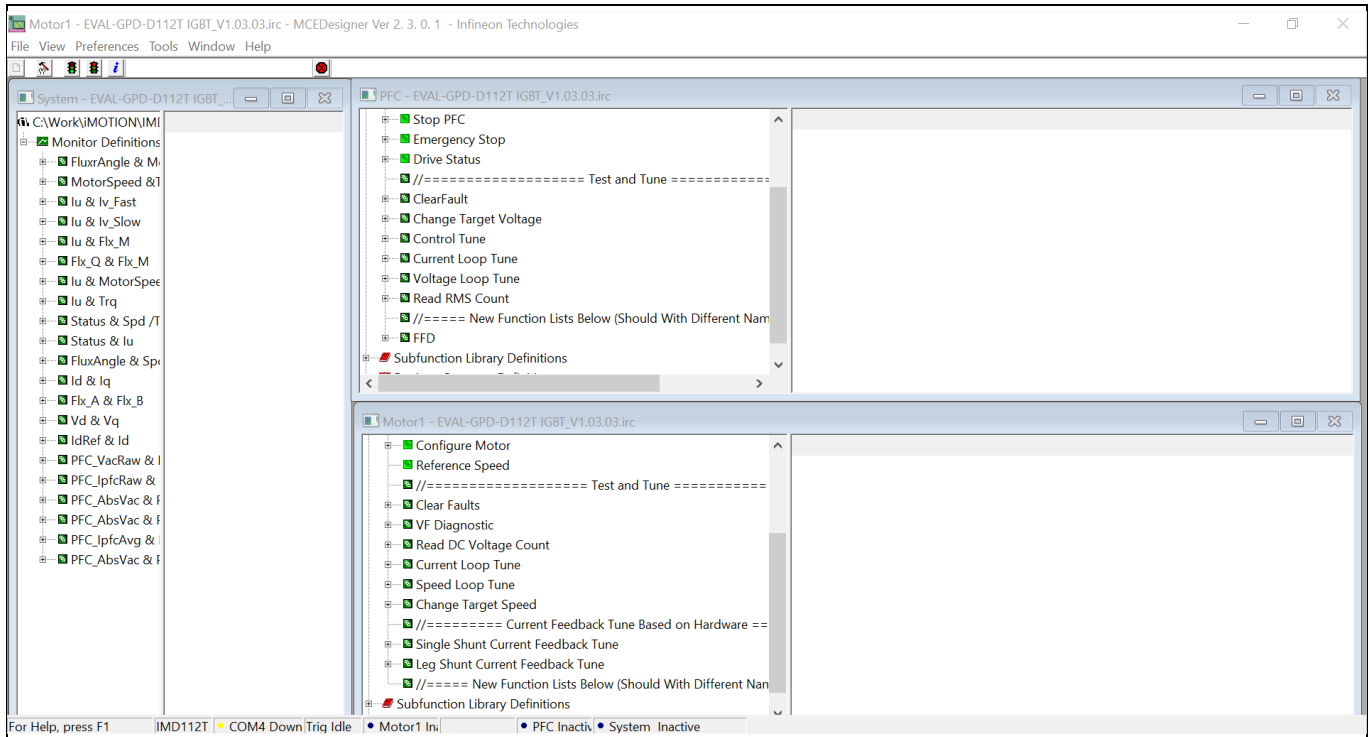

Figure 7 Main display for IMD112T in MCEDesigner

In the next step, the firmware (.ldf file) and parameters (.txt file) need to be programmed into flash. The firmware programming is not necessary if users do not want to change the .ldf file version that has been already programmed for the evaluation board manufacturing test of the IMD112T. These steps need to be followed:

1. Click on **Tools** in the **System** window and select **Programmer** from the drop-down list.
2. Choose the relevant .ldf file and text file.
3. Click **Start** to program the .ldf and .txt files.

The .ldf file can be downloaded from Infineon’s website. The .txt file was created by the MCEWizard as described in Chapter 3.2.1. The programming window is shown in Figure 8.

After the firmware and parameters are programmed, the system will be ready to run the motor. Users can click the green traffic light to start the motor or click the red traffic light to stop the motor. Users can now check, in real time, the waveform of phase current, Flx_M, motor speed, and other register values when they double-click the monitor items in the system window.

EVAL-IKA15N65ET6 User Guide

Getting started

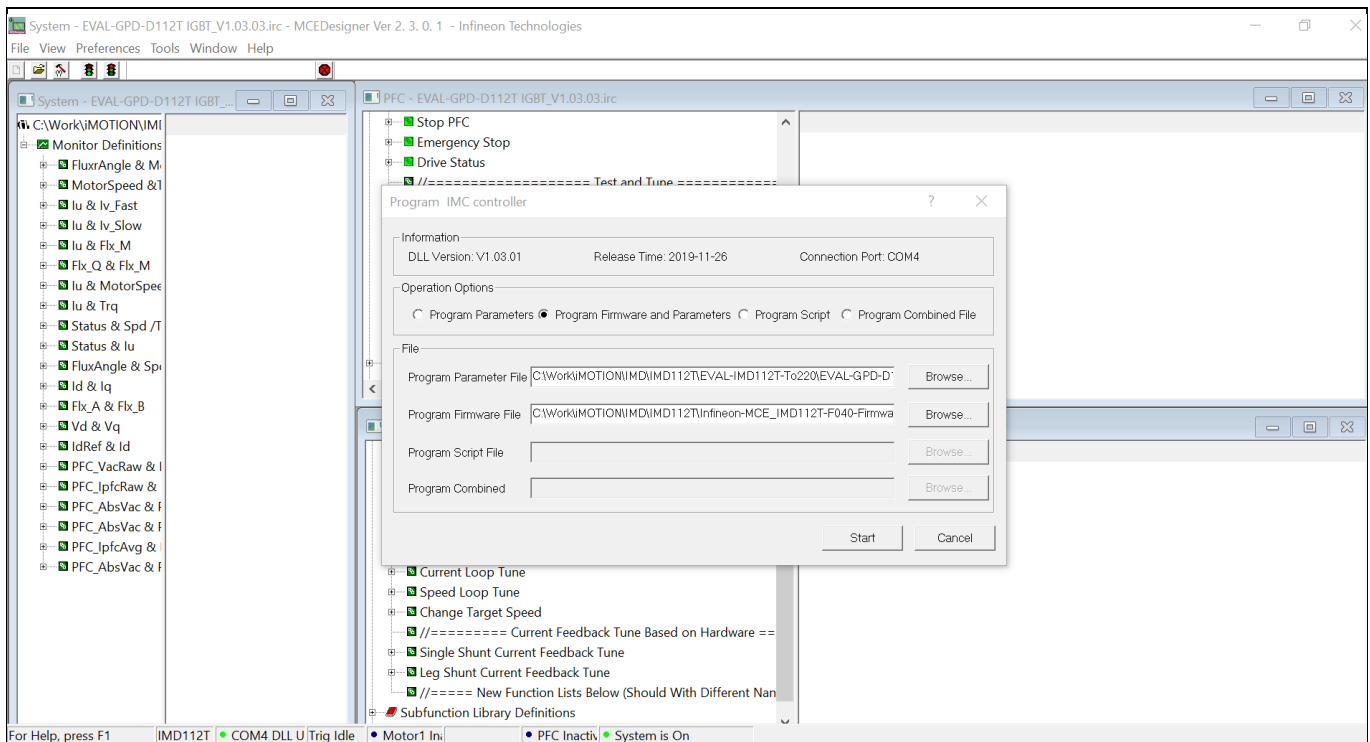
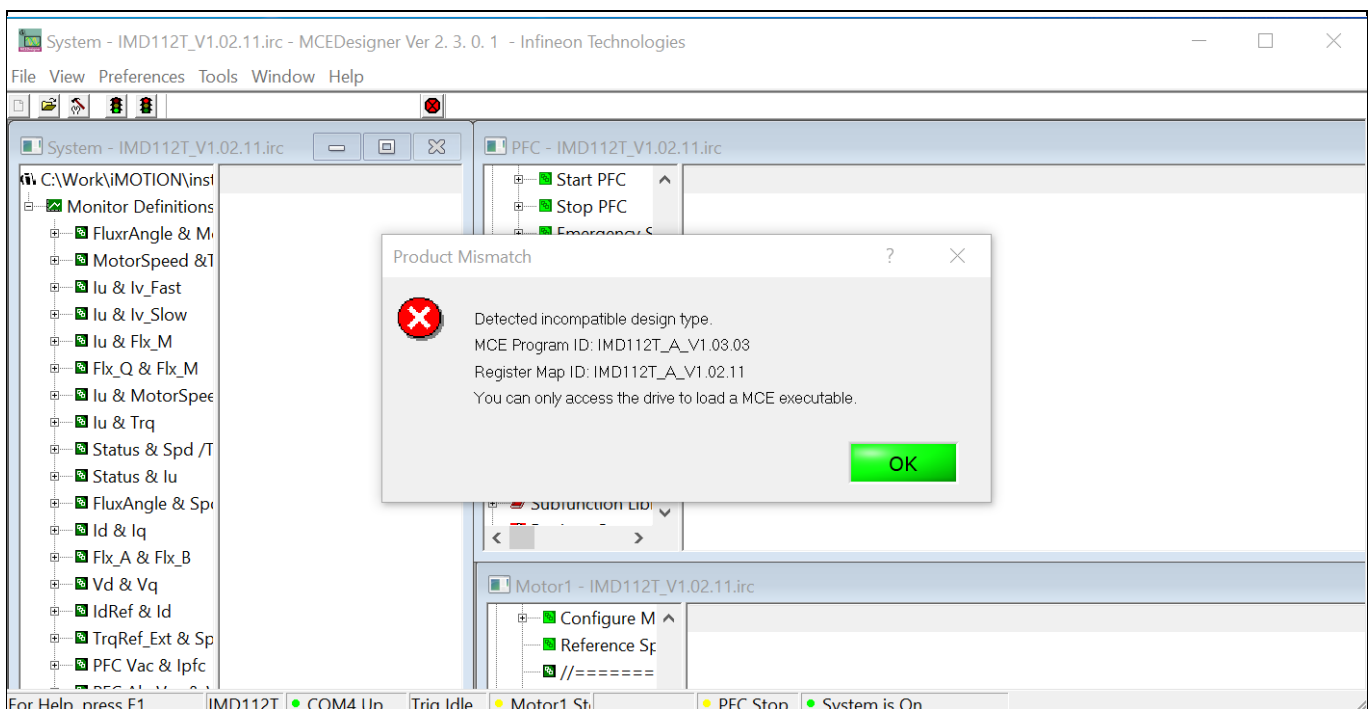

Figure 8 Pop-up window: Program IMD112T controller

3.2.3 Firmware version update

When the board test starts, a pop-up window may appear in the MCEDesigner tool, as shown in Figure 9. This message indicates that the firmware and register map version are incompatible. To solve this issue, users have to close the pop-up window and re-program the firmware they want to use. If users want to test the board with the latest firmware, they can download the latest version from Infineon’s website. Then they need to open the latest MCEDesigner configuration file (.irc file) and re-program the latest firmware file (.ldf file).



EVAL-IKA15N65ET6 User Guide

Getting started

Figure 9 Incompatible map version window

All the latest firmware files and iMOTION™ tools can be found on Infineon’s website (<http://www.infineon.com/imotion-software>).

3.2.4 Programming Hall sensor TLI4971

The evaluation board uses two TLI4971-A025T5-E0001 Hall sensors for current sensing. One sensor is used for PFC current sensing and the other one is used for inverter current sensing. The Hall sensor TLI4971 is a high-precision, coreless current sensor for industrial applications in an 8 x 8 SMD package. These sensors are configured in a single-ended mode, in which an external analog reference voltage V_{REF} is provided as an input.

All user-programmable parameters, such as overcurrent detection (OCD) thresholds, deglitching filter settings, and output configuration mode are stored in an embedded EEPROM memory. This memory can be programmed in the application through a serial inspection and configuration interface (SICI). A current sensor programmer board and a GUI software tool are required to program the sensor. This tool can be downloaded from Infineon’s website ([link](#)). The current sensor programmer board ([link](#)) is essential to program the EEPROM memory. Figure 10 shows the Hall sensor EEPROM programming window. For programming details, please download the application note and datasheet for the programming guide and the user manual from Infineon’s website.

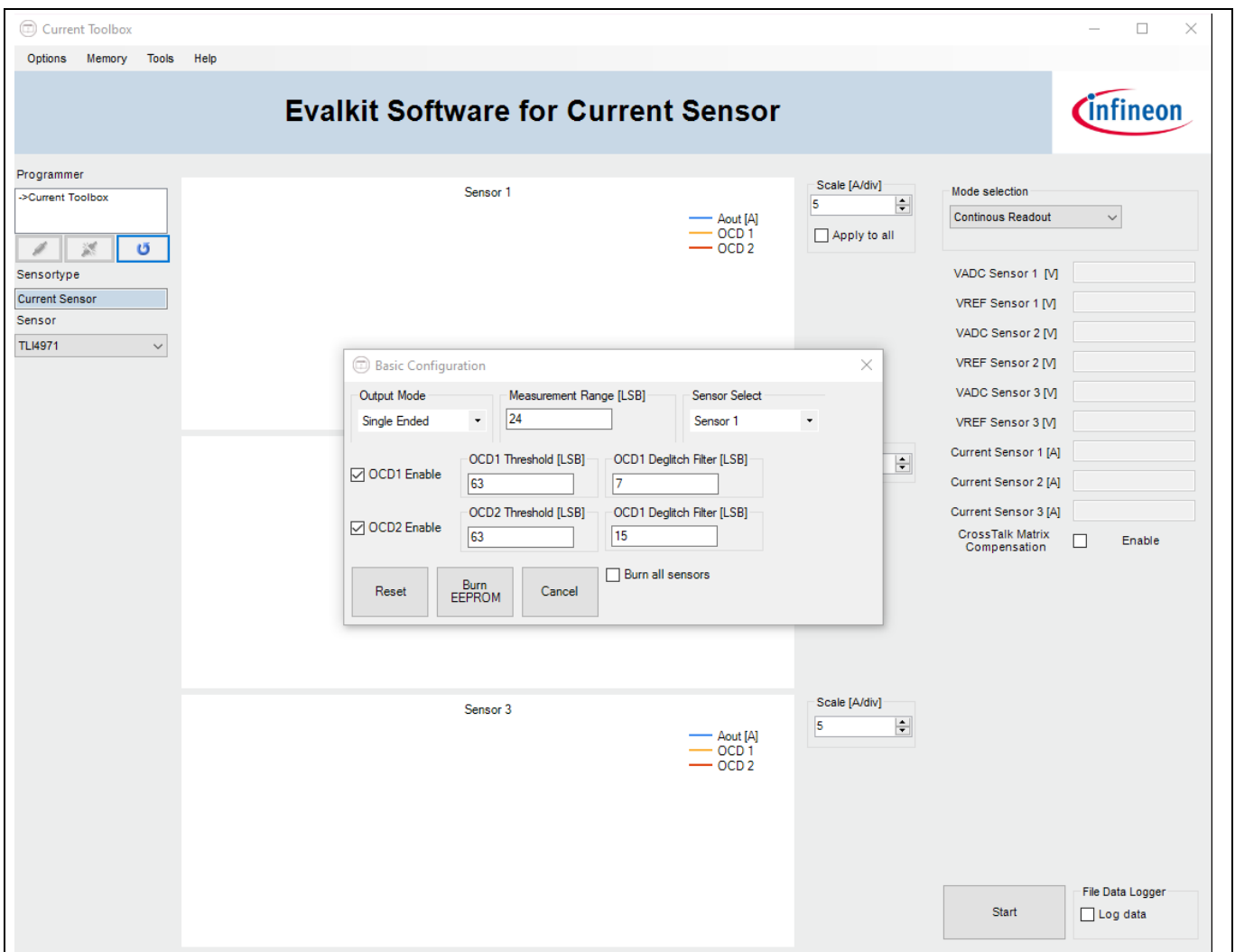

Figure 10 TLI4971 Hall sensor programming page

EVAL-IKA15N65ET6 User Guide

Getting started

For programming TLI4971, the programmer board's output terminal should be connected to the EVAL-IKA15N65ET6 board, as shown in Figure 11. The programmer board has three channels for connecting three sensors at the same time. For EVAL-IKA15N65ET6, users can use two channels to connect the two Hall sensors, as shown in Figure 11, and then select sensor 1 or sensor 2 to program the two TLI4971 sensors in the programming pop-up window. Of course, only one channel is needed to program the two Hall sensors separately; there is no need to connect the sensors together. For example, when users use channel 1 to program the PFC current sensor, they only need to connect programmer connector pins 1, 4, 14, and 20 with TP2, TP1, TP5, and TP6, respectively, on the evaluation board. After programming the PFC Hall sensor, users need to keep pin 14 and pin 20 connections for 3.3 V and GND. Pin 1 and pin 4 connections can be moved to TP7 and TP8 on the evaluation board for programming the inverter current sensor.

When programming the Hall sensor, the jumper cap must be unplugged from the connector J8 on the EVAL-IKA15N65ET6 board. After finishing the TLI4971 programming, the jumper cap should be plugged in again to J8.

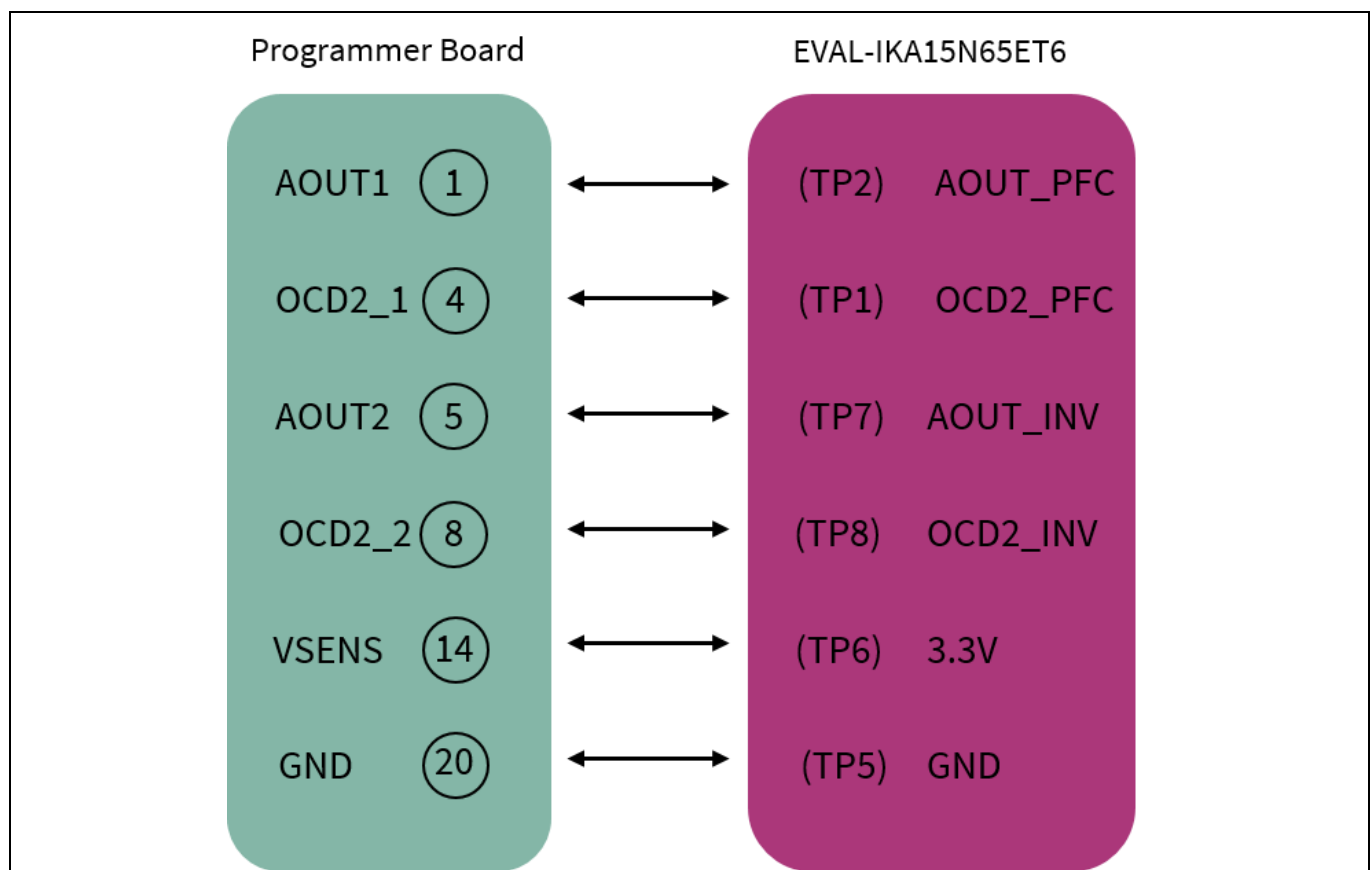

Figure 11 TLI4971 programming connections

4 Hardware description

All necessary technical data such as schematic diagrams, layouts, and components that are needed to meet customer requirements and make EVAL-IKA15N65ET6 a basis for development or modifications are described in this chapter.

This evaluation board consists of the following functional blocks:

- Motor controller
- PFC stage
- 3-phase power stage
- Current sensing
- Auxiliary power supply

4.1 Motor controller

The board uses the iMOTION™ IMD112T-6F040 smart driver as the motor controller. IMD112T-6F040 is part of the IMD110 series of highly integrated ICs for controlling variable speed drives. It integrates the motor controller with a high voltage, 3-phase gate driver and a voltage regulator in a single package.

Controller's PWM outputs are internally connected to the gate driver inputs. Two controller digital pins are also connected to the gate driver's enable input and fault output. The integrated voltage regulator generates 5 V to supply the controller and can share the same 15 V supply rail as the gate driver.

The motor controller uses the Motion Control Engine to create a ready-to-use solution to control the PMSM, providing the shortest time to market for any motor system at lowest system and development cost. The integrated script engine provides application flexibility to users without interfering with the motor and PFC control algorithm.

4.2 PFC stage

The EVAL-IKA15N65ET6 board contains a boost PFC stage to reduce the reactive power and total harmonic distortion (THD) in the grid.

The PFC function on the evaluation board is performed by TRENCHSTOP™ 5 WR6 IGBT IKWH30N65WR6 combined with the silicon power diode IDW30E65D1. The TRENCHSTOP™ 5 WR6 IGBT in a high creepage and clearance TO-247-3-HCC package is optimized for PFC topologies. The Rapid 1 silicon power diode in a TO-247 package has excellent compatibility with the IGBT.

PFC shapes the input current of the power supply to be synchronized with the mains voltage to maximize the real power drawn from the mains. In an ideal PFC circuit, the input current follows the input voltage as a pure resistive load, without any input current harmonics.

The main stage schematic for EVAL-IKA15N65ET6 is shown in Figure 12.

EVAL-IKA15N65ET6 User Guide

Hardware description

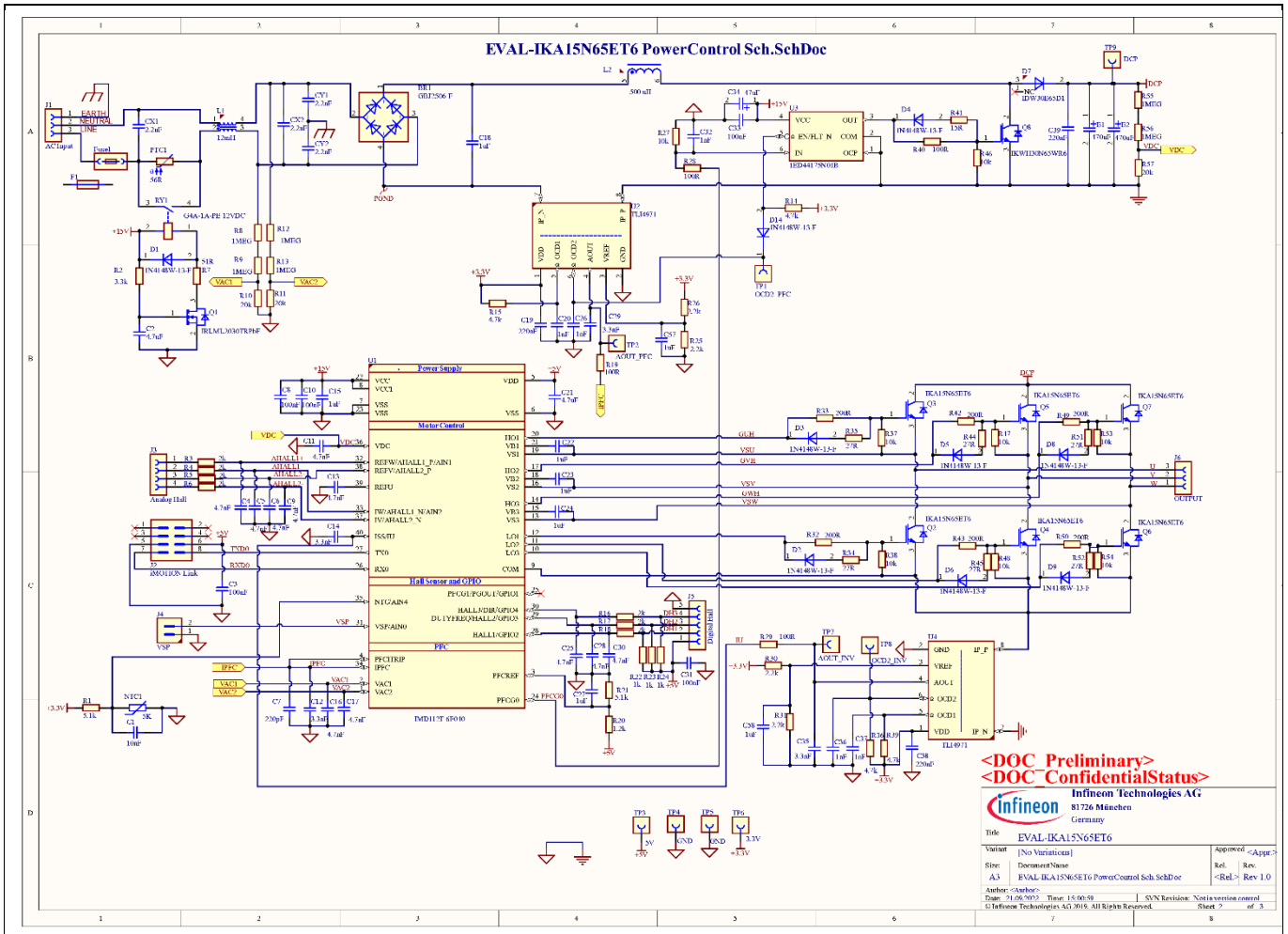

Figure 12 Main stage schematic

4.3 Current sensing

The TLI4971 Hall sensor is used on the evaluation board for PFC and inverter current sensing. It provides non-contact, galvanically isolated testing.

TLI4971 is a high-precision sensor for AC and DC measurements with analog interface and two fast overcurrent detection outputs. Infineon's well-established and robust monolithic Hall technology enables accurate and highly linear measurement of currents with full scale up to ± 120 A. Negative effects such as saturation and hysteresis that are common in open loop sensors using flux concentration techniques are thus avoided. The sensor is equipped with an internal self-diagnostic feature.

4.4 Power stage

The TRENCHSTOP™ IGBT6 technology provides reduced switching losses, good controllability, and an optimized relationship between switching and conduction losses to address various motor drive applications having fundamentally different characteristics.

The 3-phase, 2-level inverter on the board is realized using TRENCHSTOP™ IGBT6 IKA15N65ET6. It is mounted on the common heat sink with the PFC stage. The key performance parameters of IKA15N65ET6 are:

- $V_{CE} = 650$ V
- $I_C = 15$ A

EVAL-IKA15N65ET6 User Guide

Hardware description

- Package: PG-TO-220-3 FP

4.5 Auxiliary power supply

The auxiliary power supply of the EVAL-IKA15N65ET6 board uses ICE5GR4780AG of the CoolSET™ series to generate:

- 15 V that is used for motor controller and heat sink fan
- 3.3 V that is used for current sensor and discrete driver for PFC

ICE5GR4780AG is a 5th generation integrated power IC with fixed frequency from the CoolSET™ series, optimized for off-line switch mode power supply in cascode configuration. The cascode configuration enables fast startup of the system. The CoolSET™ package has two separate chips—a controller chip and a 800 V CoolMOST™ chip. The frequency-reduction technology with soft gate driving and frequency jitter operation offers lower EMI and better efficiency between light load and at 50% load. The product has a wide operating range (10.0 ~ 25.5 V) of IC power supply and lower power consumption. The numerous protection functions with adjustable line overvoltage protection support the power supply system in failure situations.

Figure 13 shows the schematic diagram of the auxiliary power supply of the EVAL-IKA15N65ET6 board. The circuit includes ICE5GR4780AG that is used to generate 15 V and 6 V through the fixed-frequency flyback topology from the DC bus. The linear voltage regulator TLS202B1MBV33 generates 3.3 V from a 6 V power supply. The 3.3 V power supply is used to supply both the TL4971 Hall sensors and the temperature sensing circuit (see Figure 12) that can enable a software protection interrupt in case of an overtemperature event, as described in MCEWizard.

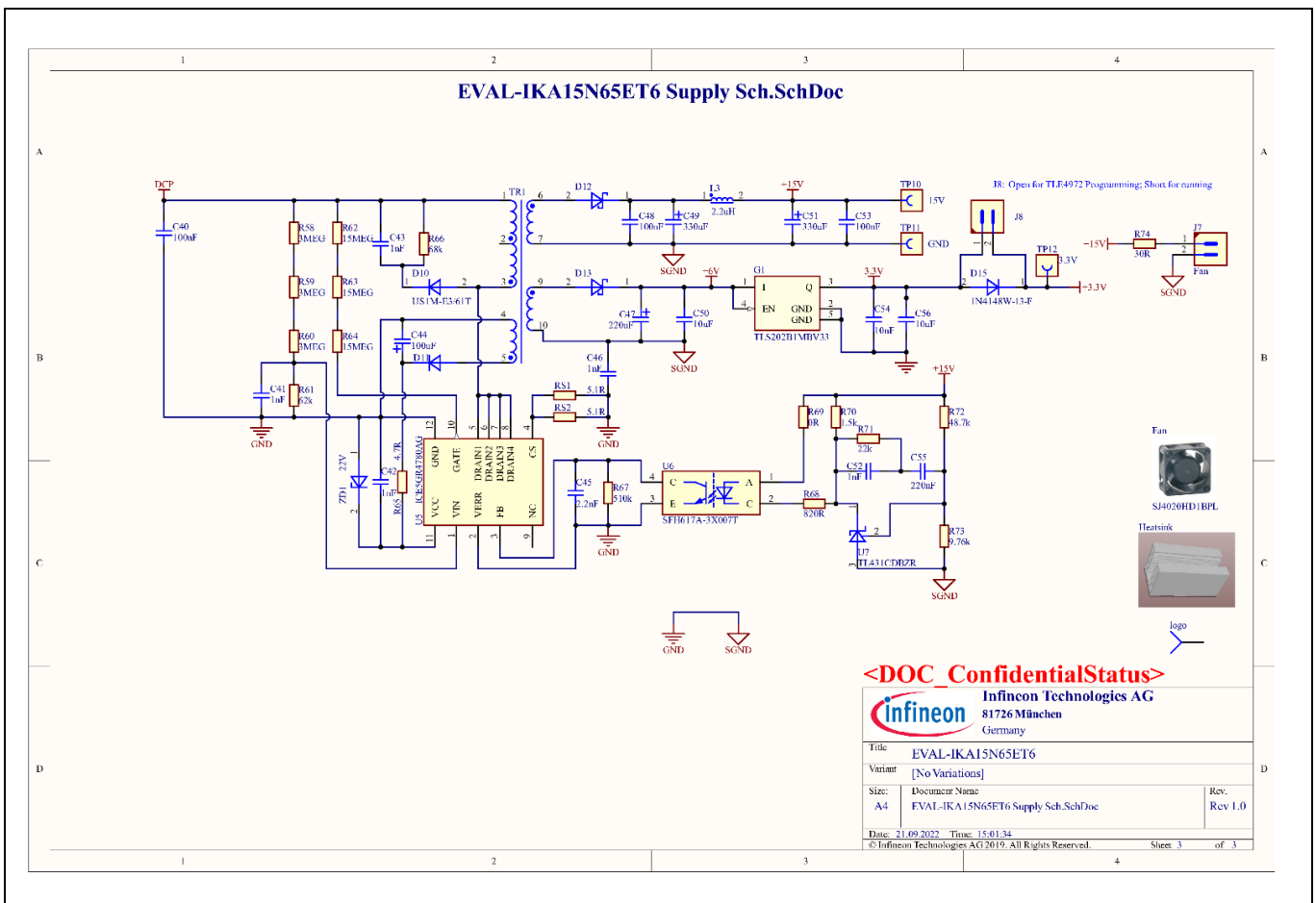

Figure 13 Auxiliary power supply section of the EVAL-IKA15N65ET6 board

EVAL-IKA15N65ET6 User Guide

Hardware description

4.6 PCB layout of EVAL-IKA15N65ET6

The layout of this board can be used for different voltage or power classes. By default, the PCB has two electrical layers with 35 µm copper, and dimensions of 178 mm × 125 mm. The PCB board thickness is 1.6 mm. Users can contact Infineon’s technical support team for more detailed information and the latest design files.

Figure 14 illustrates the top layer routing of the evaluation board.

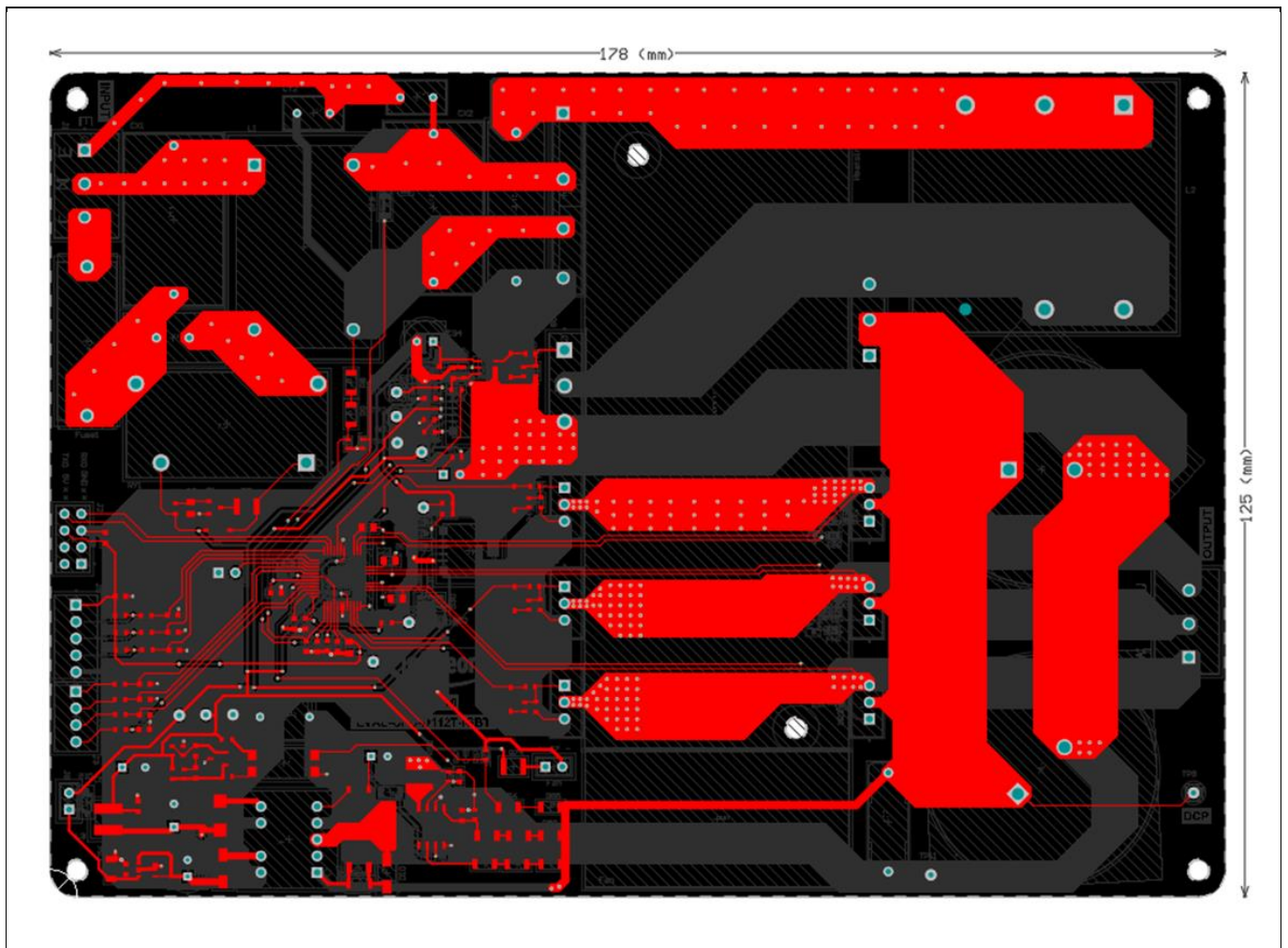

Figure 14 Top layer routing of the EVAL-IKA15N65ET6 evaluation board

Figure 15 shows the bottom layer routing of the evaluation board.

EVAL-IKA15N65ET6 User Guide

Hardware description

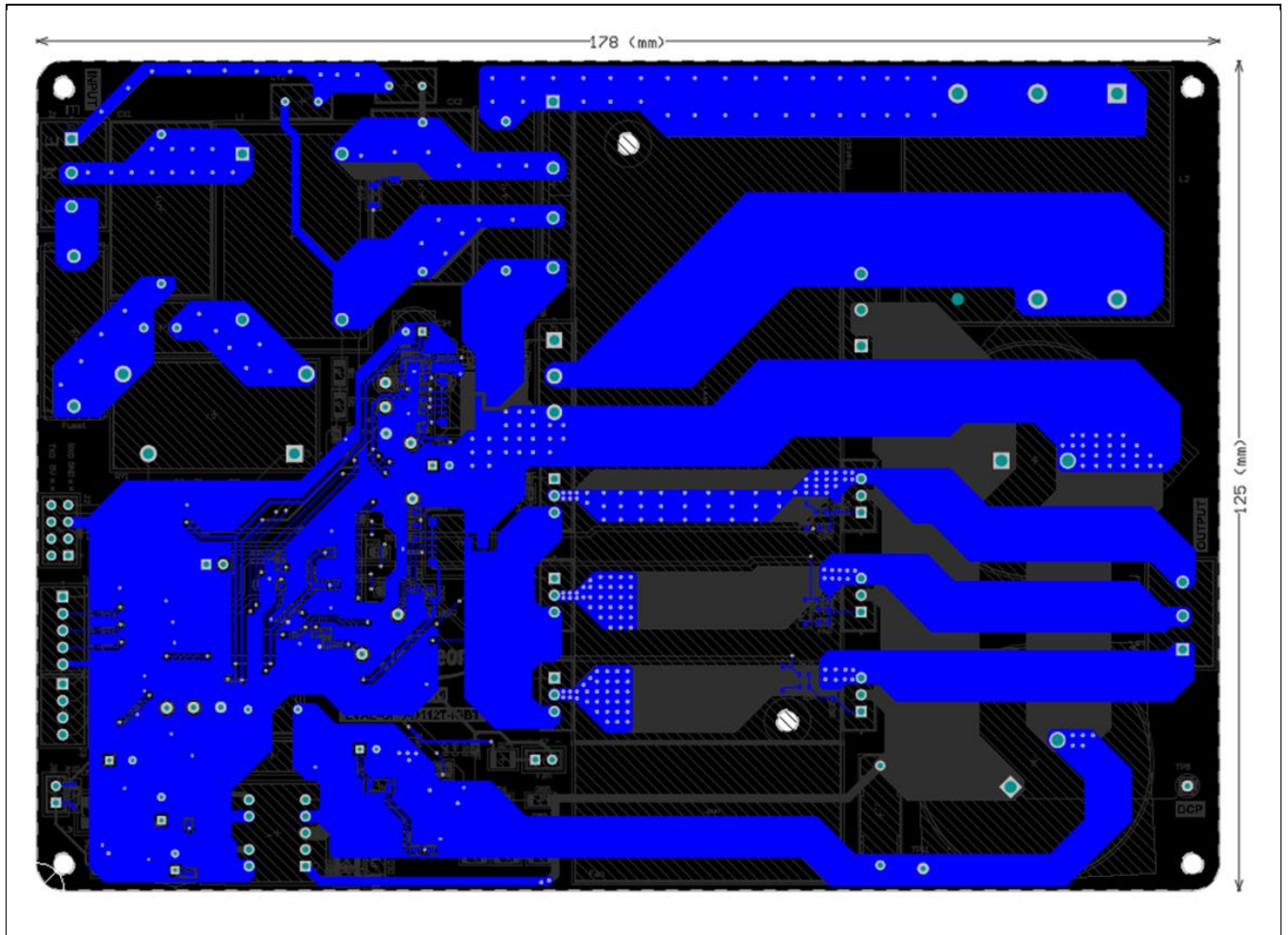

Figure 15 Bottom layer routing of the EVAL-IKA15N65ET6 evaluation board

EVAL-IKA15N65ET6 User Guide

Bill of material

5 Bill of material

Table 5 provides the complete bill of material of EVAL-IKA15N65ET6.

Table 5 Bill of materials

No.	Qty	Part description	Designator	Part number	Manufacturer
1	1	25A GLASS PASSIVATED BRIDGE RECTIFIER	BR1	GBJ2506-F	Diodes Incorporated
2	2	CAP / CERA / 10nF / 50V / 10% / X7R (EIA) / -55°C to 125°C / 0603 / SMD / -	C1, C54	06035C103K4Z2A	AVX
3	2	CAP / CERA / 4.7uF / 25V / 20% / X5R (EIA) / -55°C to 85°C / 0805 (2012) / SMD / -	C2, C21	885012107018	Würth Elektronik
4	5	CAP / CERA / 100nF / 25V / 5% / X7R (EIA) / -55°C to 125°C / 0603(1608) / SMD / -	C3, C8, C10, C31, C33	C0603C104J3RAC	Kemet
5	11	CAP / CERA / 4.7nF / 25V / 1% / COG (EIA) / NP0 / -55°C to 125°C / 0603 / SMD / -	C4, C5, C6, C9, C11, C13, C16, C17, C25, C28, C30	C0603C472F3GAC	Kemet
6	1	CAP / CERA / 220pF / 25V / 5% / - / -55°C to 125°C / 0603 / SMD / -	C7	885012006040	Würth Elektronik
7	4	CAP / CERA / 3.3nF / 50V / 5% / COG (EIA) / NP0 / -55°C to 125°C / 0603(1608) / SMD / -	C12, C14, C29, C35	GRM1885C1H332JA01	MuRata
8	4	CAP / CERA / 1uF / 50V / 10% / X7R (EIA) / -55°C to 125°C / 0805 / SMD / -	C15, C22, C23, C24	CGA4J3X7R1H105K125AB	TDK Corporation
9	1	CAP / FILM / 1uF / 400V / 5% / MKP (Metallized Polypropylene) / -40°C to 105°C / 22.50mm C X 0.80mm W 26.00mm L X 8.50mm T X 18.00mm H / THT / -	C18	890283326009CS	Würth Elektronik
10	2	CAP / CERA / 220nF / 25V / 5% / X7R (EIA) / -55°C to 125°C / 603 / SMD / -	C19, C38	C0603X224J3REC7867	Kemet
11	7	CAP / CERA / 1nF / 25V / 5% / COG (EIA) / NP0 / -55°C to 125°C /	C20, C26, C32, C36,	GRM1885C1E102JA01	MuRata

EVAL-IKA15N65ET6 User Guide

Bill of material

		0603(1608) / SMD / -, CAP / CERA / 1nF / 25V / 5% / C0G (EIA) / NP0 / -55°C to 125°C / 0603(1608) / SMD / -	C37, C42, C52		
12	3	CAP / CERA / 1uF / 25V / 10% / X5R (EIA) / -55°C to 85°C / 0603(1608) / SMD / -	C27, C57, C58	GRM185R61E105KA12	MuRata
13	1	CAP / ELCO / 47uF / 50V / 20% / Aluminium electrolytic / -40°C to 85°C / 2.50mm C X 0.50mm W 6.30mm Dia X 12.50mm H / THT / -	C34	860010673012	Würth Elektronik
14	1	CAP / FILM / 220nF / 630V / 10% / MKP (Metallized Polypropylene) / -40°C to 105°C / 15.00mm C X 0.80mm W 18.00mm L X 6.00mm T X 12.00mm H / THT / -	C39	890334025027CS	Würth Elektronik
15	1	CAP / CERA / 100nF / 630V / 10% / X7R (EIA) / -55°C to 125°C / 1812 / SMD / -	C40	885342211006	Würth Elektronik
16	1	CAP / CERA / 1nF / 16V / 10% / X7R (EIA) / -55°C to 125°C / 0603(1608) / SMD / -	C41	C0603C102K4RACTU	Kemet
17	1	CAP / CERA / 1nF / 630V / 10% / X7R (EIA) / -55°C to 125°C / 1206(3216) / SMD / -	C43	GRM31BR72J102KW01	MuRata
18	1	CAP / ELCO / 100uF / 35V / 20% / Aluminium electrolytic / -40°C to 85°C / 2.50mm C X 0.50mm W 6.30mm Dia X 12.50mm H / - / -	C44	860010573007	Würth Elektronik
19	1	CAP / CERA / 2.2nF / 50V / 10% / X5R (EIA) / -55°C to 85°C / 0603(1608) / SMD / -	C45	GRM188R61H222KA01	MuRata
20	1	CAP / CERA / 1nF / / 20% / E (JIS) / -40°C to 125°C / 7.50mm C X 0.60mm W 7.00mm L X 7.00mm T X 10.00mm H / THT / -	C46	DE6E3KJ102MN3A	MuRata

EVAL-IKA15N65ET6 User Guide

Bill of material

21	1	CAP / ELCO / 220uF / 16V / 20% / Aluminium electrolytic / -40°C to 85°C / 2.50mm C X 0.50mm W / 6.30mm Dia X 12.50mm H / THT / -	C47	860010373010	Würth Elektronik
22	2	CAP / CERA / 100nF / 50V / 10% / X7R (EIA) / -55°C to 125°C / 603(1608) / SMD / -	C48, C53	06035C104K4Z2A	AVX
23	2	CAP / ELCO / 330uF / 25V / 20% / Aluminium electrolytic / -40°C to 85°C / 3.50mm C X 0.60mm W / 8.00mm Dia X 13.00mm H / THT / -	C49, C51	860010474012	Würth Elektronik
24	1	CAP / CERA / 10uF / 16V / 10% / X5R (EIA) / -55°C to 85°C / 0805(2012) / SMD / -	C50	GRM219R61C106KA73	MuRata
25	1	CAP / CERA / 220nF / 25V / 10% / X5R (EIA) / -55°C to 85°C / 0603(1608) / SMD / -	C55	GRM188R61E224KA88	MuRata
26	1	CAP / CERA / 10uF / 16V / 5% / X7R (EIA) / -55°C to 125°C / 1206 / SMD / -	C56	C1206C106J4RAC	Kemet
27	2	CAP / FILM / 2.2uF / 630V / 10% / MKT (Metallized Polyester) / -40°C to 105°C / 22.50mm C X 0.80mm W 26.00mm L X 15.00mm T X 25.50mm H / THT / -	CX1, CX2	890324026034CS	Würth Elektronik
28	2	CAP / CERA / 2.2nF / 1kV / 20% / Y5U (EIA) / -40°C to 125°C / 5.00mm C X 0.60mm W 9.00mm L X 5.00mm T X 13.00mm H / THT / -	CY1, CY2	VY2222M35Y5US6TV5	Vishay
29	10	Surface Mount Fast Switching Diode	D1, D2, D3, D4, D5, D6, D8, D9, D14, D15	1N4148W-13-F	Diodes Incorporated
30	1	Rapid-switching emitter-controlled diode	D7	IDW30E65D1	Infineon Technologies

EVAL-IKA15N65ET6 User Guide

Bill of material

31	1	Surface Mount Ultrafast Rectifier 1.0A/1000V	D10	US1M-E3/61T	Vishay
32	1	Super-fast Recovery Diode, VR 200 V, IF 1 A	D11	RF071MM2STR	ROHM Semiconductors
33	1	High Voltage Surface-Mount Schottky Rectifier, VRRM 100V	D12	SS2H10-E3/52T	Vishay
34	1	Surface-Mount Schottky Barrier Rectifier, VRRM 45V	D13	BYS10-45-E3/TR3	Vishay
35	2	CAP / ELCO / 470uF / 450V / 20% / Aluminium electrolytic / -25°C to 85°C / 10.00mm C X 1.50mm W 35.00mm Dia X 49.00mm H / THT / -	E1, E2	861011486024	Würth Elektronik
36	1	FUSE CERAMIC 12.5A 250VAC 125VDC,5x20mm	F1	0001.2715.11	Schurter
37	1	Axial DC Fan	Fan	SJ4020HD1BPL	-
38	1	Fuse Holder Block, PCB Clip Cover, 18A, 250VAC	Fuse1	696101000002	Würth Elektronik
39	1	Fixed Linear Voltage Post Regulator, 3.3V	G1	TLS202B1MBV33	Infineon Technologies
40	1	Standard Heatsink, FL16-023, 40x40x100mm	Heatsink	HS4040-100-U	Fengling
41	2	Horizontal Cable Entry With Rising Cage Clamp - WR-TBL, 3Pins	J1, J6	691216510003S	Würth Elektronik
42	2	Connector, 2.54mm pitch, 8pins, Board to Board, Through Hole	J2, J8	61300821121	Würth Elektronik
43	1	Terminal Block 4 Pin	J3	691210910004	Würth Elektronik
44	2	Header, 2.54mm Pitch, 2 pin, Vertical, Single Row	J4, J7	61300211121	Würth Elektronik
45	1	Terminal Block 5 Pin	J5	691210910005	Würth Elektronik
46	1	IND / STD / 12mH / 10A / 50% / -40°C to 125°C / 15mR / THT / Inductor, THT, 4 pin, 23.00 mm L X 34.00 mm W X 33.00 mm H body / THT / -	L1	7448051012	Würth Elektronik
47	1	IND / STD / - / - / - / - / - / - / THT / Inductor, THT; 6 pin, 38.00 mm L X 40.00 mm W X 40.00 mm H body / THT / -	L2	PI191035V1	POCO Holding Co., Ltd

EVAL-IKA15N65ET6 User Guide

Bill of material

48	1	IND / STD / 2.2uH / 2.5A / 20% / -40°C to 125°C / 71mR / SMD / Inductor, SMD; 2-Leads, 4.50 mm L X 4 mm W X 3.50 mm H body / SMD / -	L3	744773022	Würth Elektronik
49					
50	1	Varistor (Voltage-Sensitive Resistor)	NTC1	B57703M502G40	TDK Corporation
51	1	RES / PTC / 56R / - / 25% / - / -40°C to 125°C / 2 Pin, 15.00 mm L X 7.50 mm W X 19.00 mm H body / - / -	PTC1	B59451C1130B070	TDK Corporation
52	1	HEXFET Power MOSFET VDS 30V	Q1	IRLML2030TRPbF	Infineon Technologies
53	6	TRENCHSTOP IGBT6	Q2, Q3, Q4, Q5, Q6, Q7	IKA15N65ET6	Infineon Technologies
54	1	Reverse-conducting IGBT with monolithic body diode, powerful monolithic diode optimized for ZCS applications	Q8	IKWH30N65WR6	Infineon Technologies
55	1	RES / STD / 5.1k / 100mW / 1% / 100ppm/K / -55°C to 155°C / 0603 / SMD / -	R1	CRCW06035K10FK	Vishay
56	1	RES / STD / 3.3k / 100mW / 1% / 100ppm/K / -55°C to 155°C / 0603 / SMD / -	R2	RC0603FR-073K3L	Yageo
57	7	RES / STD / 2k / 100mW / 1% / 100ppm/K / -55°C to 155°C / 603 / SMD / -	R3, R4, R5, R6, R16, R17, R18	AC0603FR-072KL	Yageo
58	1	RES / STD / 51R / 500mW / 1% / 100ppm/K / -55°C to 155°C / 1210 / SMD / -	R7	CRCW121051R0FK	Vishay
59	6	RES / STD / 1MEG / 250mW / 1% / 100ppm/K / -55°C to 155°C / 1206 / SMD / -	R8, R9, R12, R13, R55, R56	CRCW12061M00FK	Vishay
60	3	RES / STD / 20k / 100mW / 1% / 100ppm/K / -55°C to 155°C / 0603 / SMD / -	R10, R11, R57	CRCW060320K0FK	Vishay
61	4	RES / STD / 4.7k / 100mW / 1% / 100ppm/K / -55°C to 155°C / 0603 / SMD / -	R14, R15, R36, R39	RC0603FR-074K7L	Yageo

EVAL-IKA15N65ET6 User Guide

Bill of material

62	3	RES / STD / 100R / 100mW / 1% / 100ppm/K / -55°C to 155°C / 0603 / SMD / -	R19, R28, R29	RC0603FR-07100RL	Yageo
63	1	RES / STD / 1.2k / 100mW / 0.1% / 10ppm/K / -55°C to 155°C / 603 / SMD / -	R20	ERA3ARB122V	Panasonic
64	1	RES / STD / 5.1k / 100mW / 1% / 100ppm/K / -55°C to 155°C / 0603 / SMD / -	R21	CRCW06035K10FK	Vishay
65	3	RES / STD / 1k / 100mW / 1% / 100ppm/K / -55°C to 155°C / 0603 / SMD / -	R22, R23, R24	RC0603FR-071KL	Yageo
66	4	RES / STD / 2.2k / 100mW / 1% / 100ppm/K / -55°C to 155°C / 0603 / SMD / -	R25, R26, R30, R31	RC0603FR-072K2L	Yageo
67	8	RES / STD / 10k / 100mW / 1% / 100ppm/K / -55°C to 155°C / 0603 / SMD / -	R27, R37, R38, R46, R47, R48, R53, R54	RC0603FR-0710KL	Yageo
68	6	RES / STD / 200R / 100mW / 1% / 100ppm/K / -55°C to 155°C / 0603 / SMD / -	R32, R33, R42, R43, R49, R50	CRCW0603200RFK	Vishay
69	6	RES / STD / 27R / 100mW / 1% / 100ppm/K / -55°C to 155°C / 0603 / SMD / -	R34, R35, R44, R45, R51, R52	CRCW060327R0FK	Vishay
70	1	RES / STD / 100R / 100mW / 1% / 100ppm/K / -55°C to 155°C / 0603 / SMD / -	R40	CRCW0603100R0FK	Vishay
71	1	RES / STD / 15R / 100mW / 1% / 100ppm/K / -55°C to 155°C / 0603 / SMD / -	R41	CRCW060315R0FK	Vishay
72	3	RES / STD / 3MEG / 250mW / 1% / 100ppm/K / -55°C to 155°C / 1206 / SMD / -	R58, R59, R60	CRCW12063M00FK	Vishay
73	1	RES / STD / 62k / 100mW / 1% / 100ppm/K / -55°C to 155°C / 0603 / SMD / -	R61	CRCW060362K0FK	Vishay
74	3	RES / STD / 15MEG / 250mW / 5% / 200ppm/K / -55°C to 155°C / 1206 / SMD / -	R62, R63, R64	RC1206JR-0715ML	Yageo
75	1	RES / STD / 4.7R / 250mW / 1% / 100ppm/K / -55°C to 155°C / 1206 / SMD / -	R65	CRCW12064R70FK	Vishay

EVAL-IKA15N65ET6 User Guide

Bill of material

76	1	RES / STD / 68k / 250mW / 1% / 100ppm/K / -55°C to 155°C / 1206 / SMD / -	R66	CRCW120668K0FK	Vishay
77	1	RES / STD / 510k / 100mW / 1% / 100ppm/K / -55°C to 155°C / 0603 / SMD / -	R67	CRCW0603510KFK	Vishay
78	1	RES / STD / 820R / 100mW / 1% / 100ppm/K / -55°C to 155°C / 0603 / SMD / -	R68	CRCW0603820RFK	Vishay
79	1	RES / STD / 0R / 100mW / 0R / 0ppm/K / -55°C to 155°C / 0603 / SMD / -	R69	RC0603JR-070RL	Yageo
80	1	RES / STD / 1.5k / 100mW / 1% / 100ppm/K / -55°C to 155°C / 0603 / SMD / -	R70	RC0603FR-071K5L	Yageo
81	1	RES / STD / 22k / 100mW / 1% / 100ppm/K / -55°C to 155°C / 0603 / SMD / -	R71	CRCW060322K0FK	Vishay
82	1	RES / STD / 48.7k / 100mW / 1% / 100ppm/K / -55°C to 155°C / 0603 / SMD / -	R72	CRCW060348K7FK	Vishay
83	1	RES / STD / 9.76k / 100mW / 1% / 100ppm/K / -55°C to 155°C / 0603 / SMD / -	R73	CRCW06039K76FK	Vishay
84	1	RES / STD / 30R / 500mW / 1% / 100ppm/K / -55°C to 155°C / 1210 / SMD / -	R74	CRCW121030R0FK	Vishay
85	2	RES / STD / 5.1R / 250mW / 1% / 100ppm/K / -55°C to 155°C / 1206 / SMD / -	RS1, RS2	CRCW12065R10FK	Vishay
86	1	RELAY GENERAL PURPOSE SPST 20A 12V	RY1	G4A-1A-PE 12VDC	Omron
87	12	Test Point THT, Black	TP1, TP2, TP3, TP4, TP5, TP6, TP7, TP8, TP9, TP10, TP11, TP12	5001	Keystone Electronics Corp.
88	1	Flyback Transformer, Offline aux SMPS for server, PC power applications	TR1	750344226	Würth Elektronik
89	1	Motor controller with integrated high-voltage gate driver, integrated	U1	IMD112T-6F040	Infineon Technologies

EVAL-IKA15N65ET6 User Guide

Bill of material

		script engine for application control customization, Thin-film-SOI-technology with negative transient robustness, Built-in temperature sensor			
90	2	High-precision coreless current sensor	U2, U4	TLI4971-A025T5-E0001	Infineon Technologies
91	1	Gate drivers LOW SIDE DRIVERS	U3	1ED44175N01B	Infineon Technologies
92	1	Fixed-frequency 700 V/800 V CoolSET™, lowest standby power <100 mW	U5	ICE5GR4780AG	Infineon Technologies
93	1	Optocoupler, Phototransistor Output, High Reliability, 5300 VRMS, 110°C Rated	U6	SFH617A-3X007T	Vishay
94	1	Precision Programmable Reference	U7	TL431CDBZR	Texas Instruments
95	1	Zener Diode with Surge Current Specification	ZD1	BZD27C22P-HE3-08	Vishay

6 System performance - evaluation results

This chapter describes the test bench results of different functional blocks.

Equipment

- IR camera: FLIR310A
- Scope: Tek3054
- Motor: GK6063-6AC31
- Power meter: Tektronix PA1000

Software

- IRC file: IMD112T_V1.03.03
- Firmware: IMD112T-F040_A_V1.03.03.lcf

6.1 Auxiliary power supply test

Specification

- 15 V ±1 V, 3.3 V ±5%, 5 V ±5%

Table 6 Auxiliary power supply

15 (V)	3.3 (V)	5 (V)
14.89	3.302	4.997

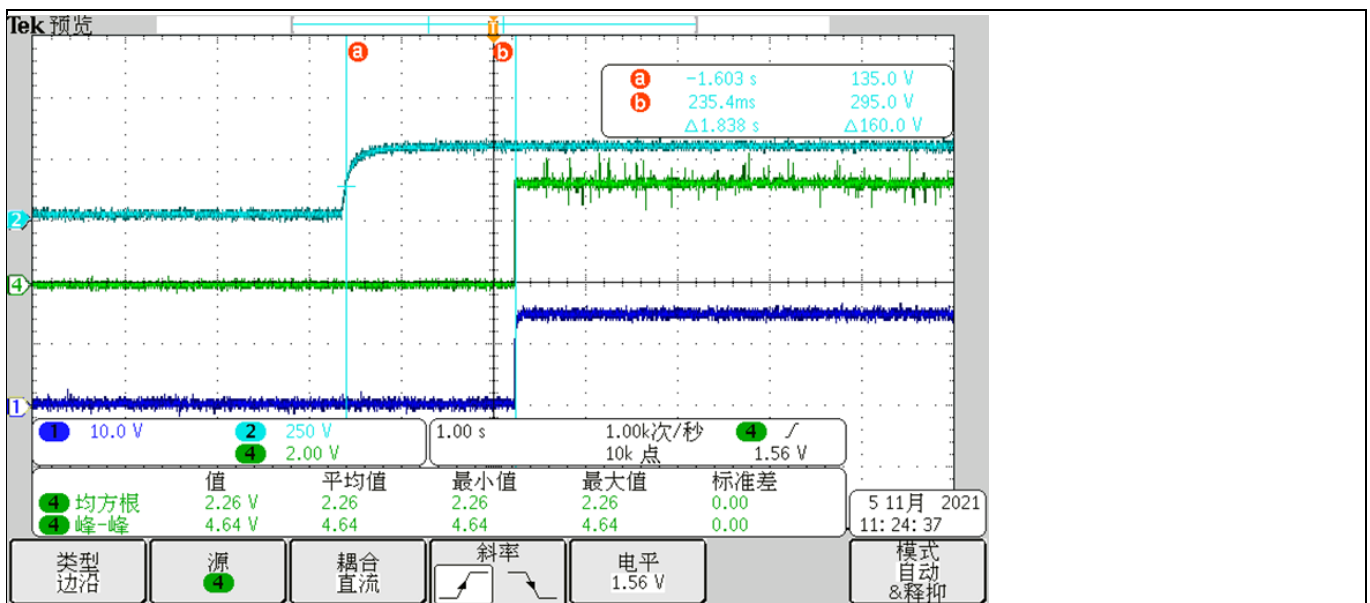

Figure 16 Auxiliary power supply

6.2 PFC test

Specification

- PF > 0.9, iTHD < 3% at full load, 220 V_{ac} input
- Input voltage range: 165 ~ 265 V_{ac}

EVAL-IKA15N65ET6 User Guide

System performance - evaluation results

- Maximum input power 1200 W

Table 7 PFC test - $f_{pwm} = 6$ kHz

Input voltage (V_{ac})	Input current (A_{rms})	Input power (W)	DC bus voltage (V)	PF	iTHD (%)	vTHD (%)	Phase current (A_{rms})	Tcase-PFC IGBT (°C)	Tcase-inv IGBT (°C)	Ta (°C)	Picture
165	3.636	593	378.5	0.986	2.167	2.209	3.86	56.7	51	22.1	Figure 17
165	7.356	1215	378.5	0.997	1.7	2.2	5.27	92.7	71.3	22.3	Figure 18
220	2.835	597	378.5	0.956	8.79	1.92	4	47.5	48.1	19.3	Figure 19
220	5.558	1202	378.5	0.988	2.155	1.863	5.11	72.6	61.1	19.8	Figure 20
265	2.362	588	378.5	0.937	14.3	2.45	3.78	45.5	47.9	21.6	Figure 21
265	4.704	1203	378.5	0.974	4.516	2.337	5.05	66.8	62.7	22.6	Figure 22

Table 8 PFC test - $f_{pwm} = 16$ kHz

Input voltage (V_{ac})	Input power (W)	DC bus voltage (V)	PF	Phase current (A_{rms})	Tcase-inv IGBT (°C)	Tcase-PFC IGBT (°C)	Ta (°C)	Picture
220	576	378	0.96	2.5	55.6	53.5	29.3	Figure 19
220	1185	378	0.989	4.65	77.1	67.3	27.9	Figure 20

Legend

- CH2: DC bus voltage (blue)
- CH3: AC line input (purple)
- CH4: line current (green)

Condition

- Typical PWM setup for: 40 kHz PFC and 6–16 kHz motor PWM, 3-phase-only mode, motor speed: maximum 2500 rpm for GK6063 motor
- PFC control parameters: $K_{pl} = 2800$, $K_{xl} = 9000$, $K_{pV} = 1000$, $K_{xV} = 50$

Results

- PF = 0.988 and iTHD = 2.155% at 1200 W input power and 220 V_{ac} input

Note: This section provides the experimental data of the EVAL-IKA15N65ET6 board under typical operating conditions. Different load, switching frequency (f_{pwm}), and input voltage conditions are included. It should be highlighted that all possible test conditions are not covered in this user guide. However, it should be expected that when 16 kHz is selected as the inverter's switching frequency and the input voltage is 165 V_{ac} , both the PFC case temperature and the inverter case temperature will increase due to thermal cross-coupling effect, reaching slightly higher values than those listed in Table 7.

EVAL-IKA15N65ET6 User Guide

System performance - evaluation results

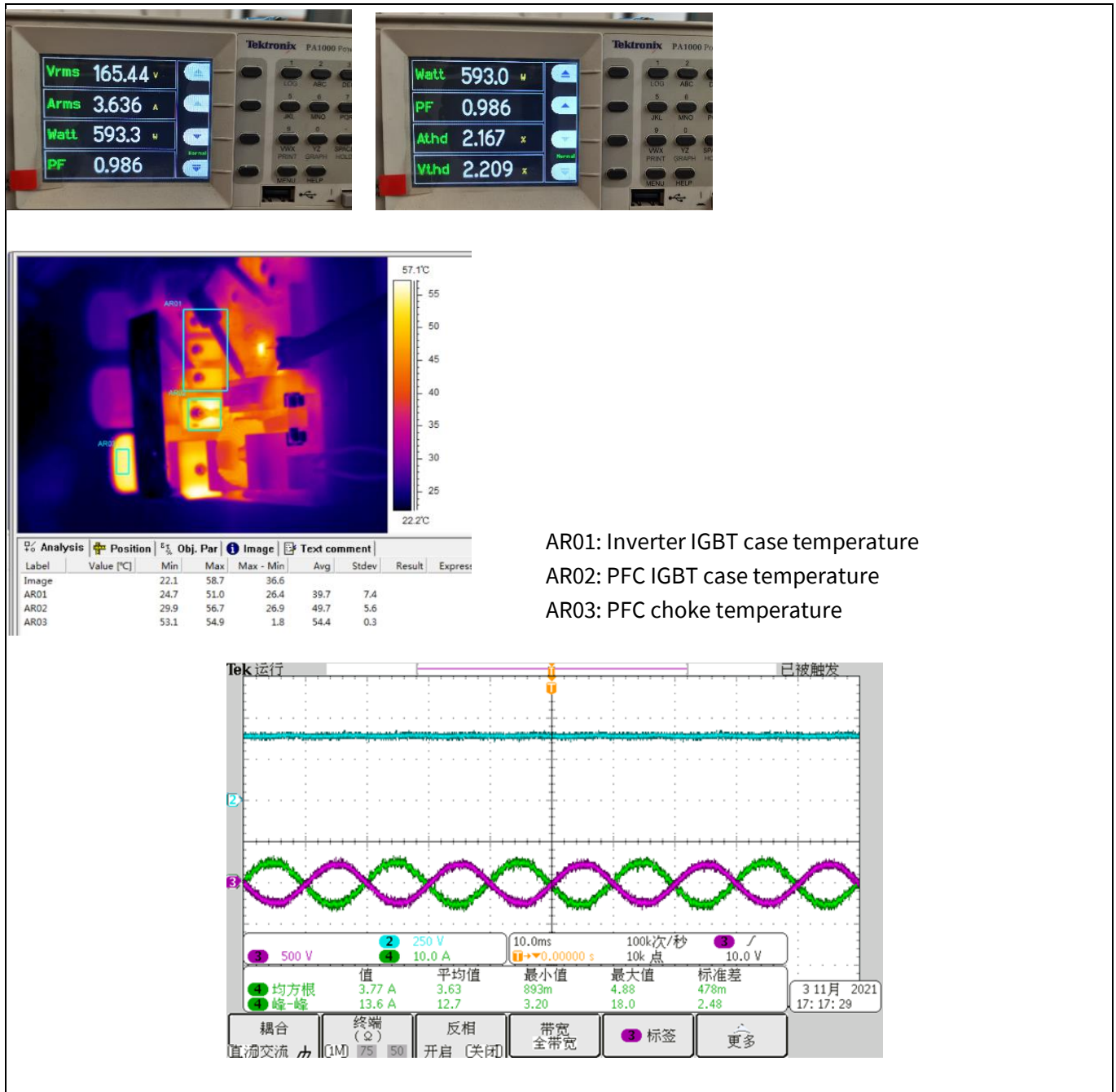

Figure 17 165 V_{ac} input and half load test

EVAL-IKA15N65ET6 User Guide

System performance - evaluation results

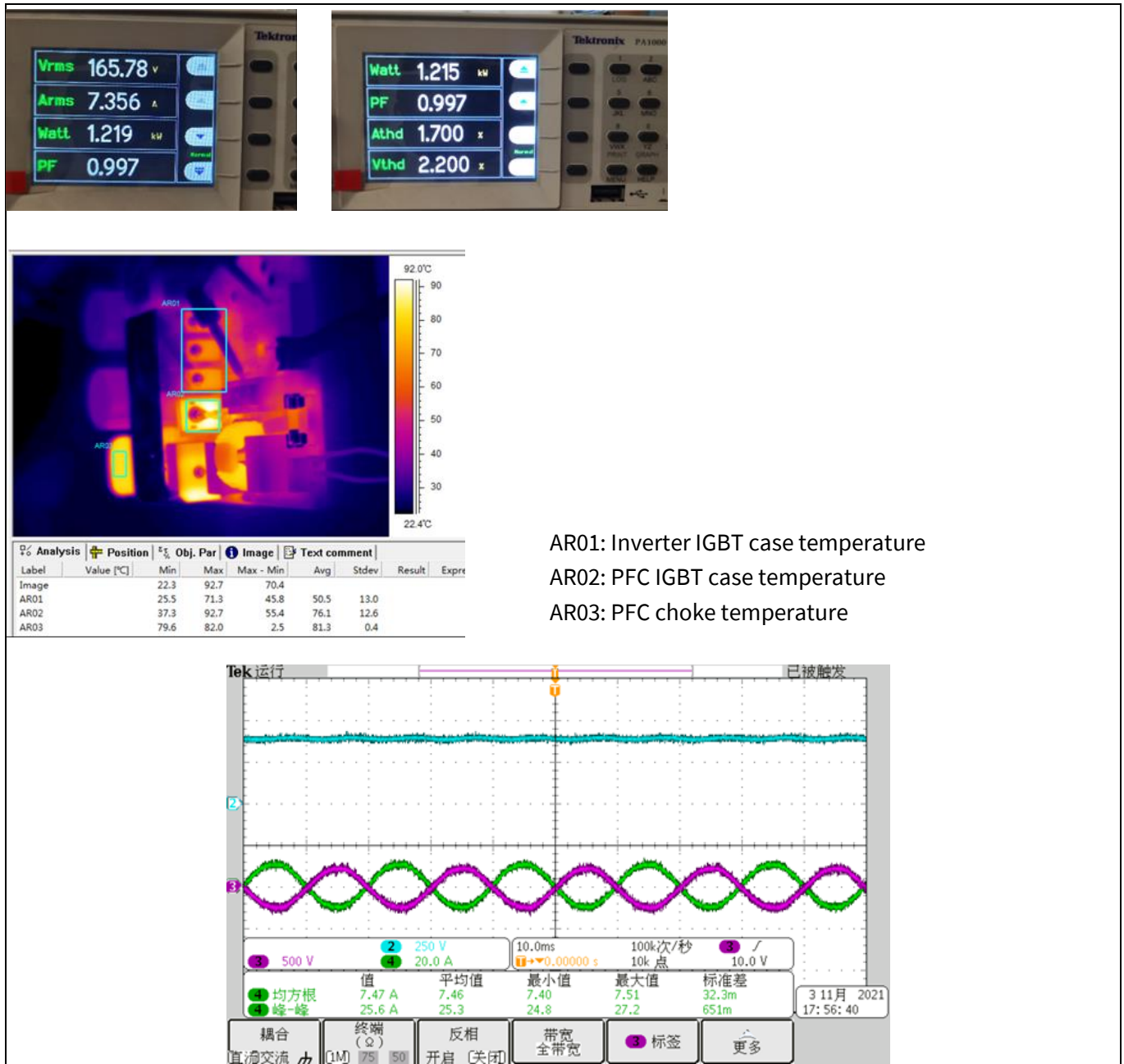

Figure 18 165 V_{ac} input and full load test

EVAL-IKA15N65ET6 User Guide

System performance - evaluation results

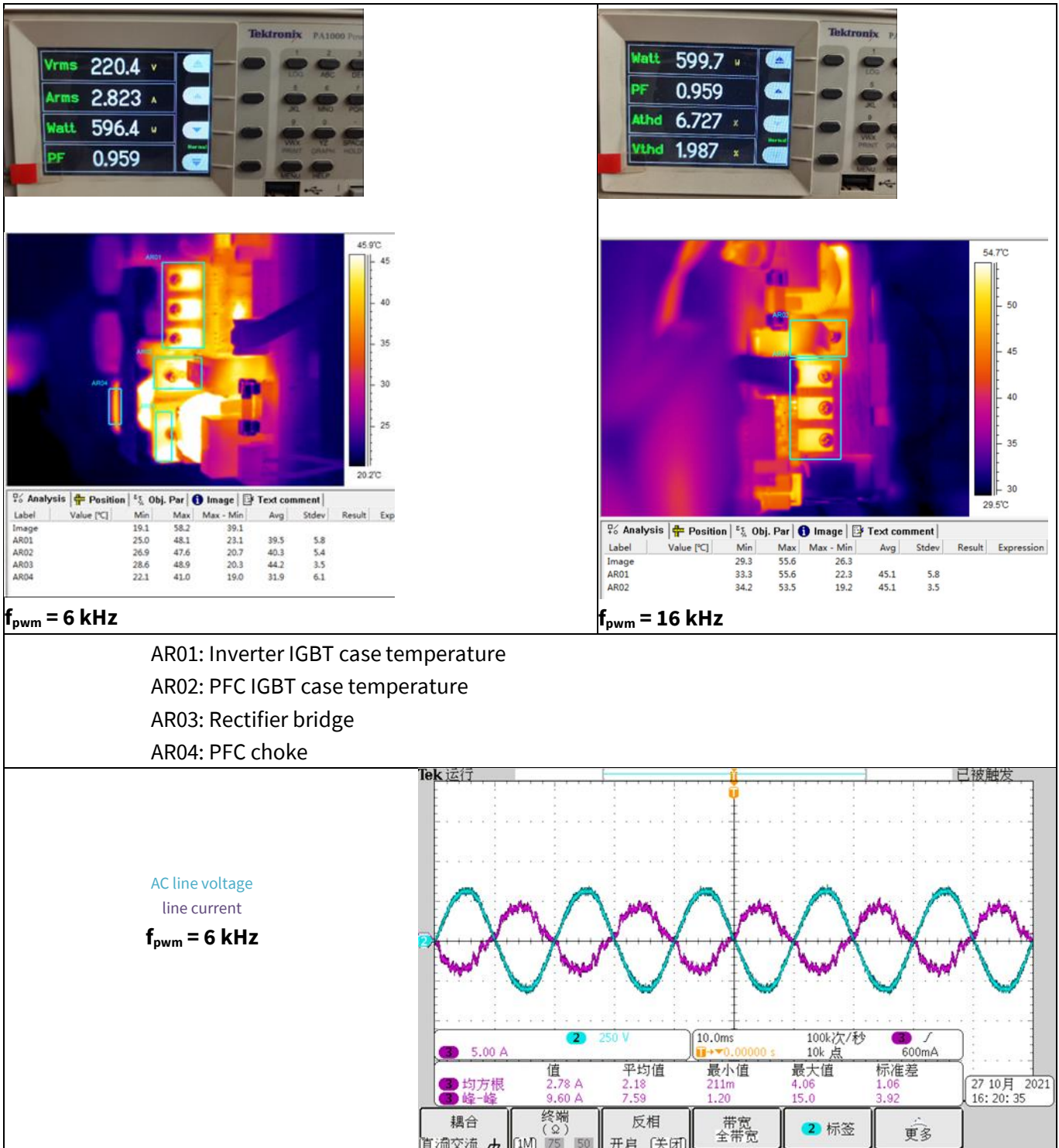

Figure 19 220 Vac input and half load test

EVAL-IKA15N65ET6 User Guide

System performance - evaluation results

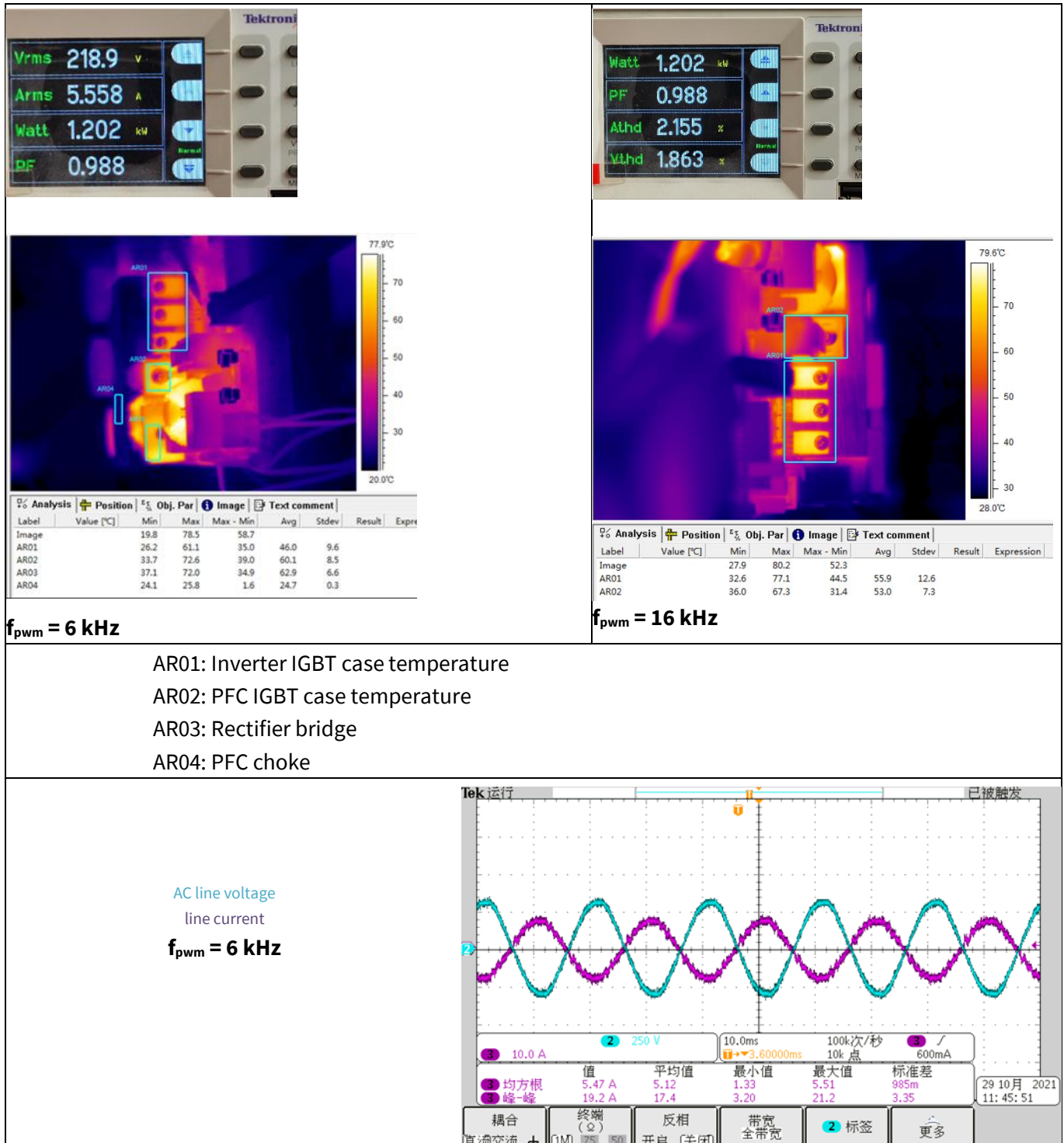
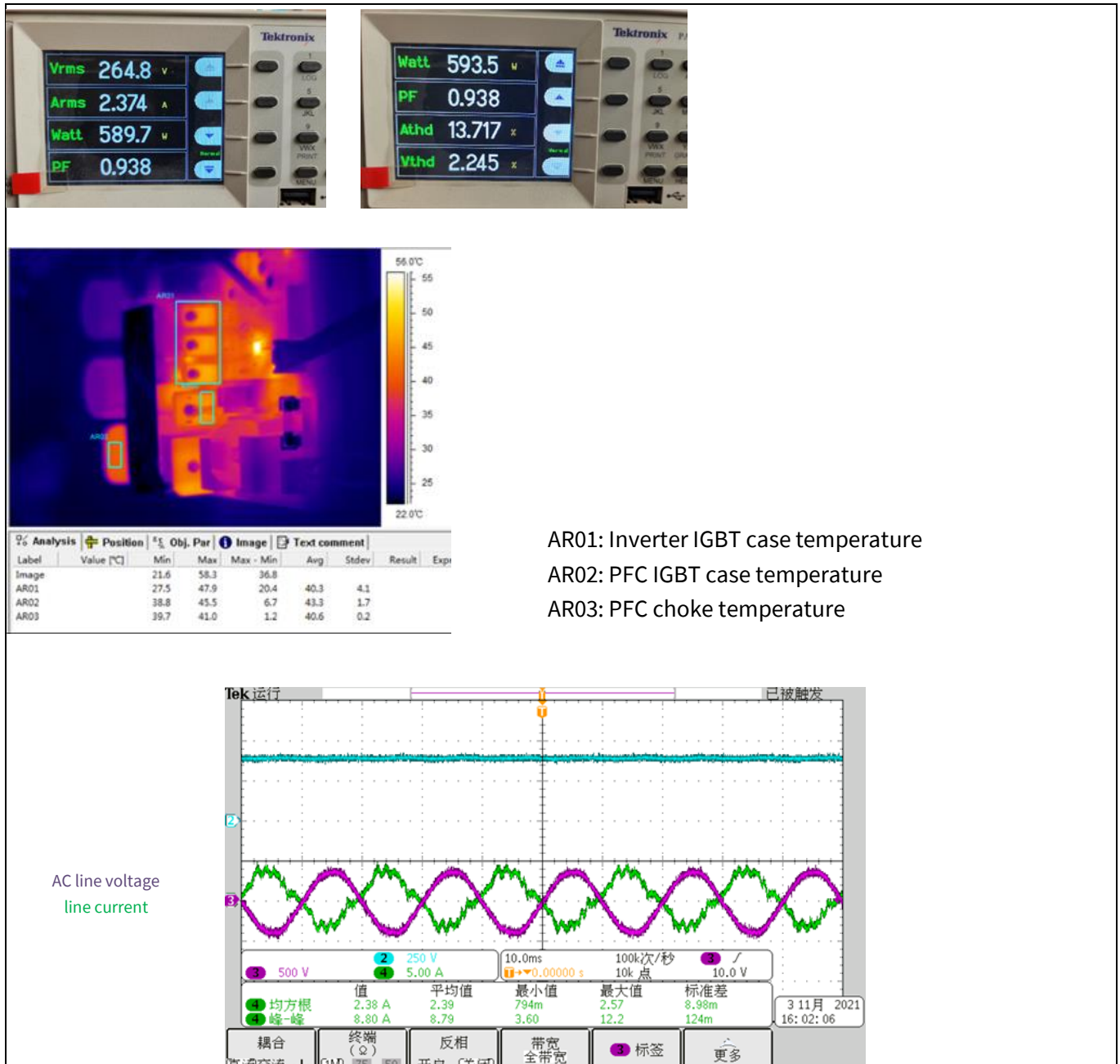

Figure 20 220 Vac input and full load test

EVAL-IKA15N65ET6 User Guide

System performance - evaluation results



AR01: Inverter IGBT case temperature
 AR02: PFC IGBT case temperature
 AR03: PFC choke temperature

Figure 21 265 Vac input and half load test

EVAL-IKA15N65ET6 User Guide

System performance - evaluation results

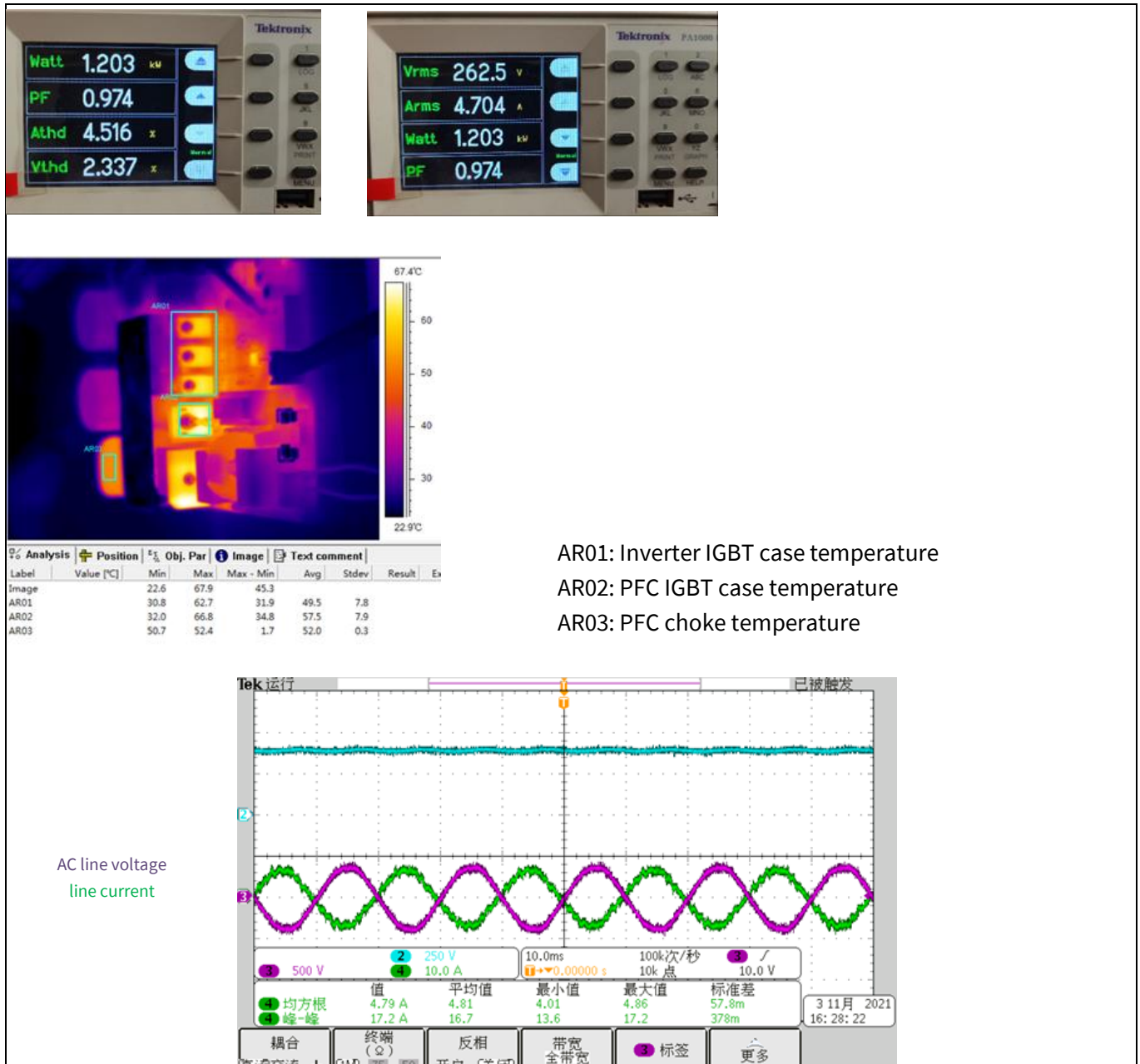

Figure 22 265 V_{ac} input and full load test

EVAL-IKA15N65ET6 User Guide

System performance - evaluation results

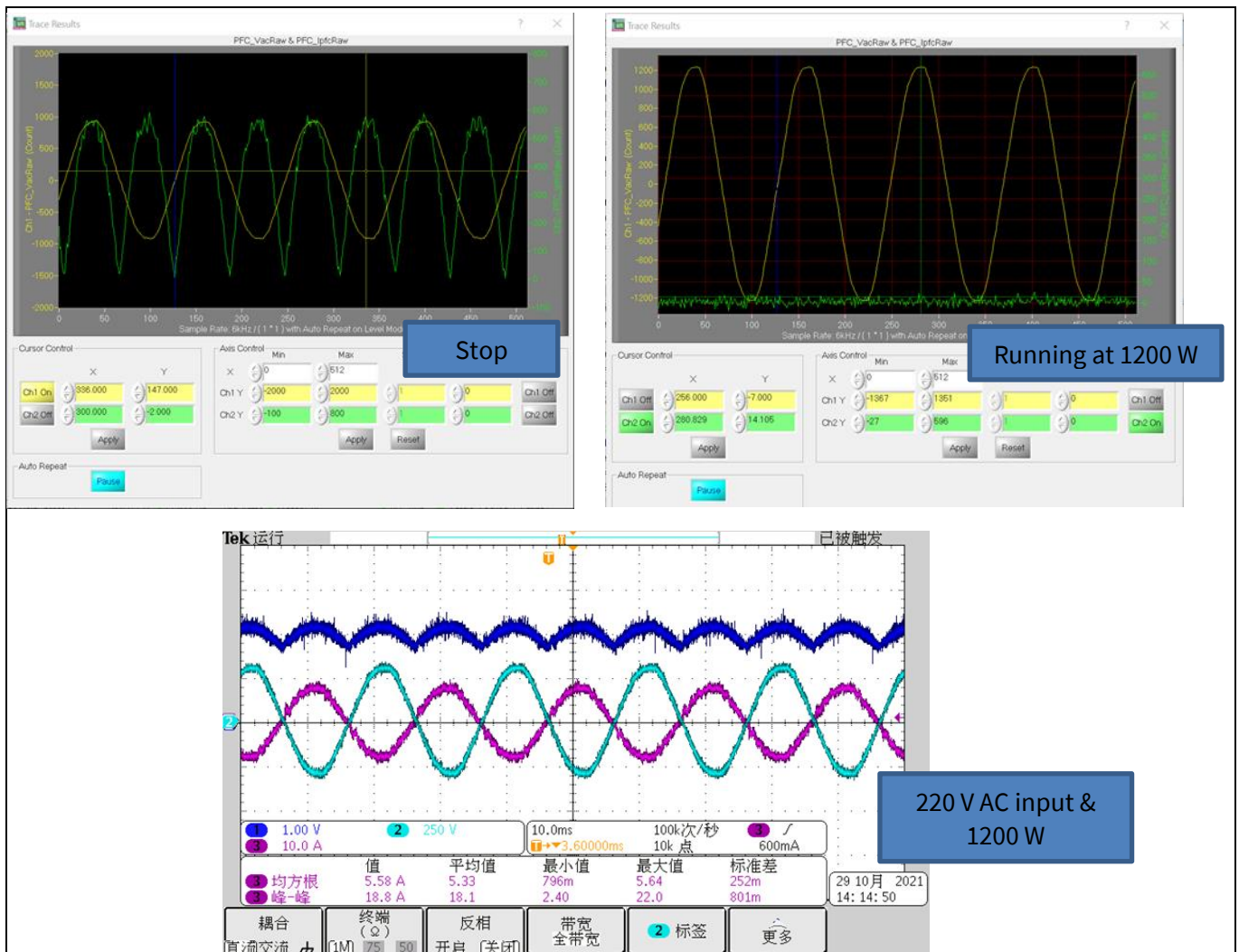

Figure 23 PFC MCE trace and scope waveforms for line current/voltage and PFC current feedback

6.3 Inverter test

Specification

- $P_{out} < 1300\text{ W}$

Table 9 Inverter test

PWM (loop rate)	MCE usage (by wizard)	Test result
PFC: 40 kHz Motor: 6 kHz	65%	MCE trace noise < 15 counts at static Motor phase current is 5 A _{rms} at 1200 W load

Condition

- Motor PWM frequency: 6 kHz, 3-phase-only mode, motor speed: maximum 2500 rpm
- PFC control parameters: $K_{pl} = 868$, $K_{xl} = 347$, $K_{pV} = 64$, $K_{xV} = 31$

Result

- P_{out} is up to 1200 W with the full pack IGBT IKA15N65ET6

EVAL-IKA15N65ET6 User Guide

System performance - evaluation results

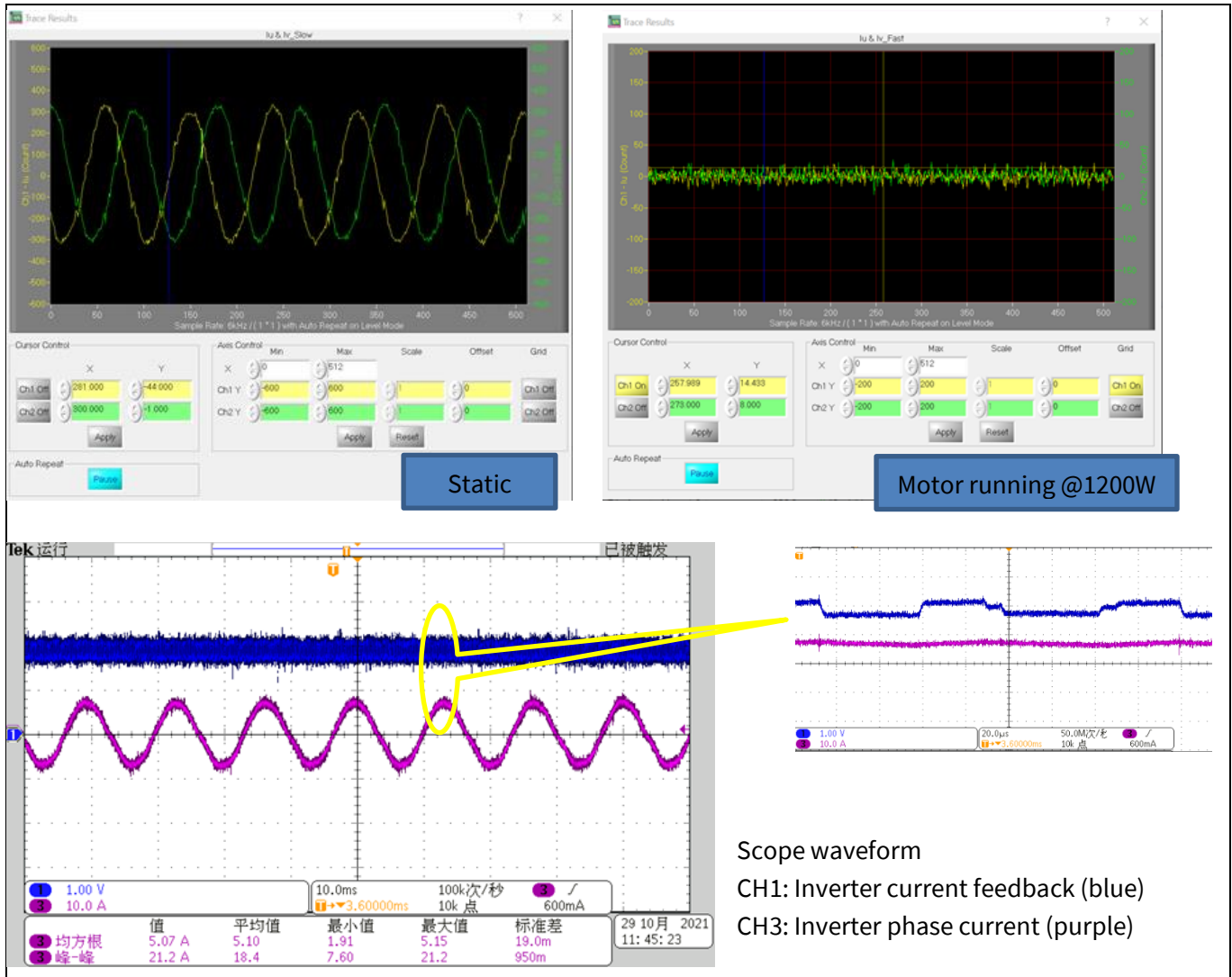

Figure 24 Inverter current waveforms

6.4 dv/dt test

Specification

- Inverter dv/dv is less than 5 V/ns

Table 10

PFC dv/dt on	PFC dv/dt off	Inv dv/dt on	Inv dv/dt off
10.8 V/ns	3.8 V/ns	3.6 V/ns	2 V/ns
Figure 25		Figure 26	

Conditions

- PFC: Turn-on Rg = 100 Ω, turn-off Rg = 15 Ω
- Inv: Turn-on Rg = 200 Ω, turn-off Rg = 27 Ω

EVAL-IKA15N65ET6 User Guide

System performance - evaluation results

Result

- Inverter dv/dt is less than 5 V/ns

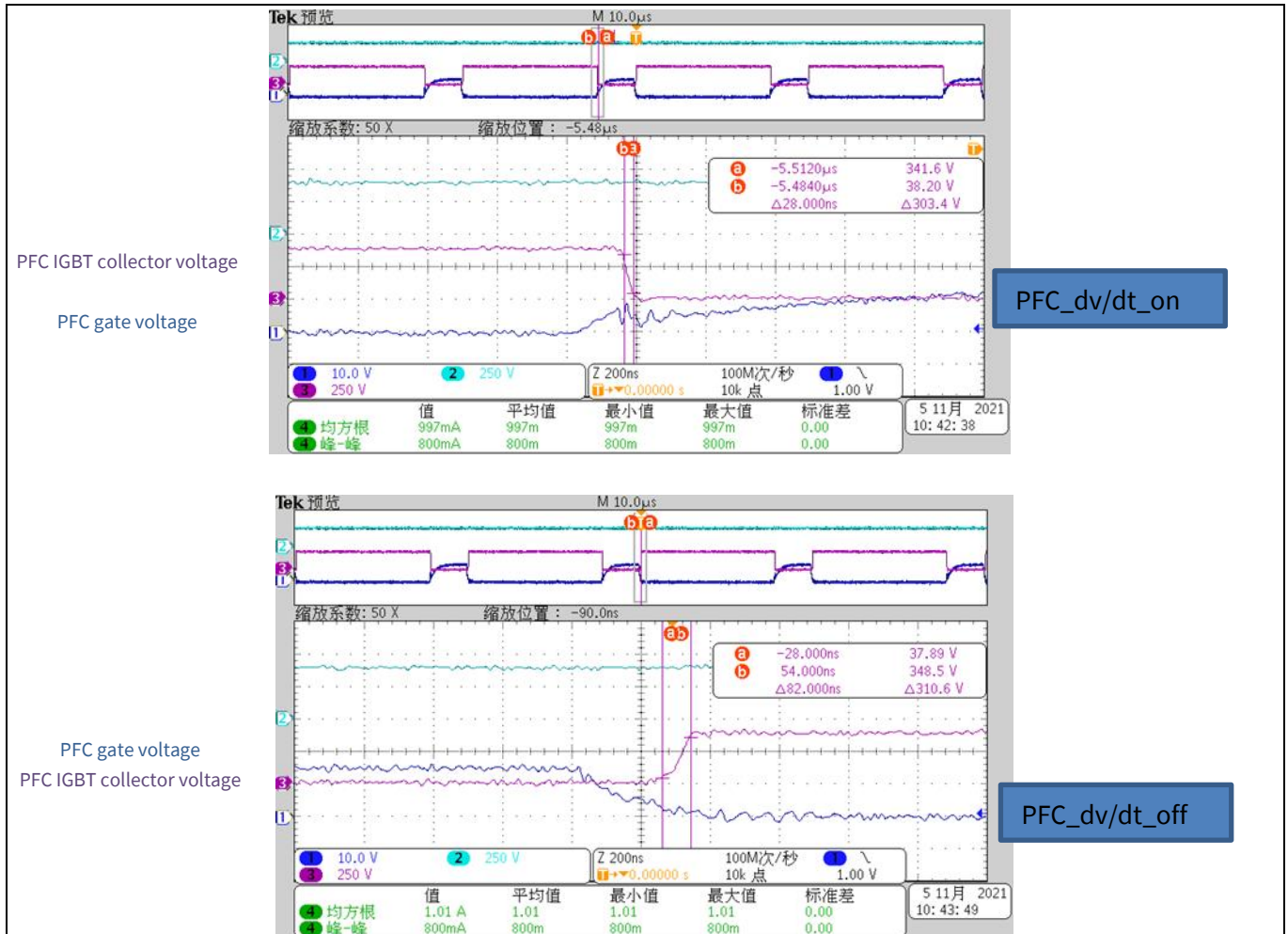

Figure 25 PFC dv/dt test

EVAL-IKA15N65ET6 User Guide

System performance - evaluation results

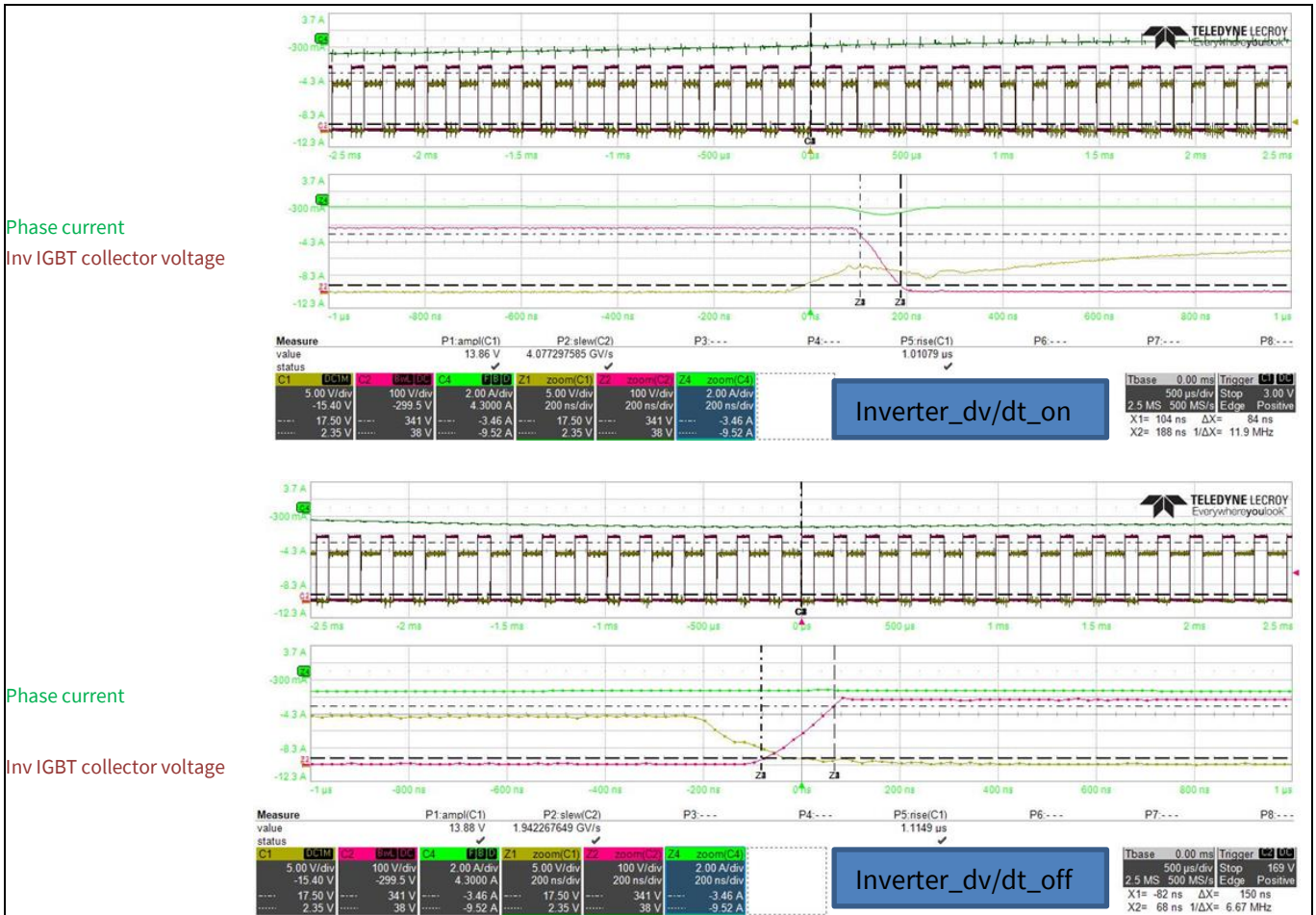

Figure 26 Inverter dv/dt test

6.5 Protection test

6.5.1 Inverter short-circuit/overcurrent protection

Condition

- Short-circuit inverter output U, V with 1 m wire. Start the motor on MCEdesigner

Result

- System was protected properly; in the MCEdesigner, the status changed to a red flag; as activated by the Gate Kill pin (see Figure 27)

EVAL-IKA15N65ET6 User Guide

System performance - evaluation results

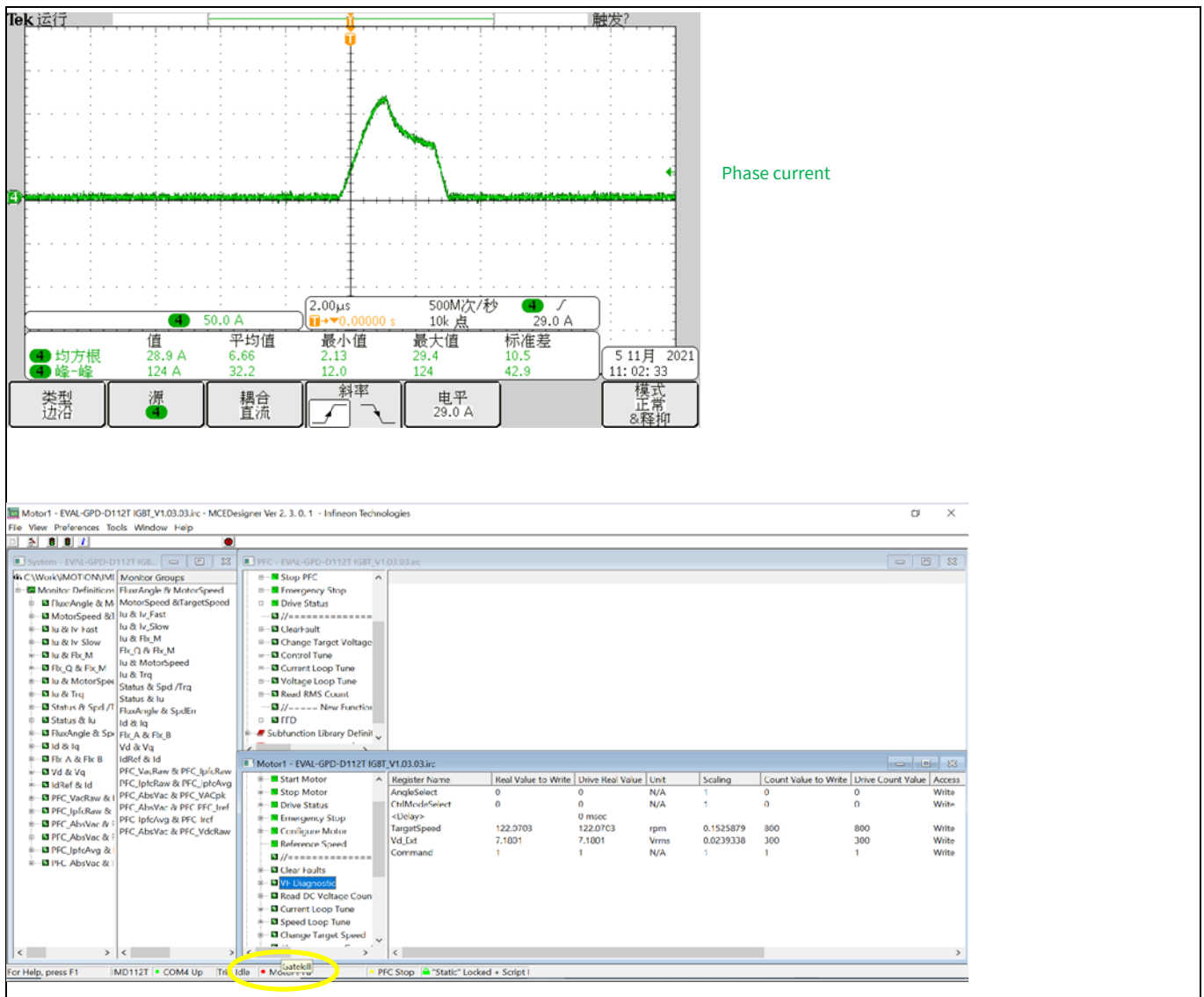

Figure 27 Inverter short-circuit protection

6.5.2 PFC overcurrent protection

Condition

- 15 V and 3.3 V power up; on adding a PWM signal to 1ED44175 input pin, then AC line powers up. The inrush current triggers the TLI4971 overcurrent protection

Result

- Set OCD1 threshold is 1.2X-time scaling. So, the OCD1 output was pulled down when the current reached $25 \times 1.2 = 30$ A

EVAL-IKA15N65ET6 User Guide

System performance - evaluation results

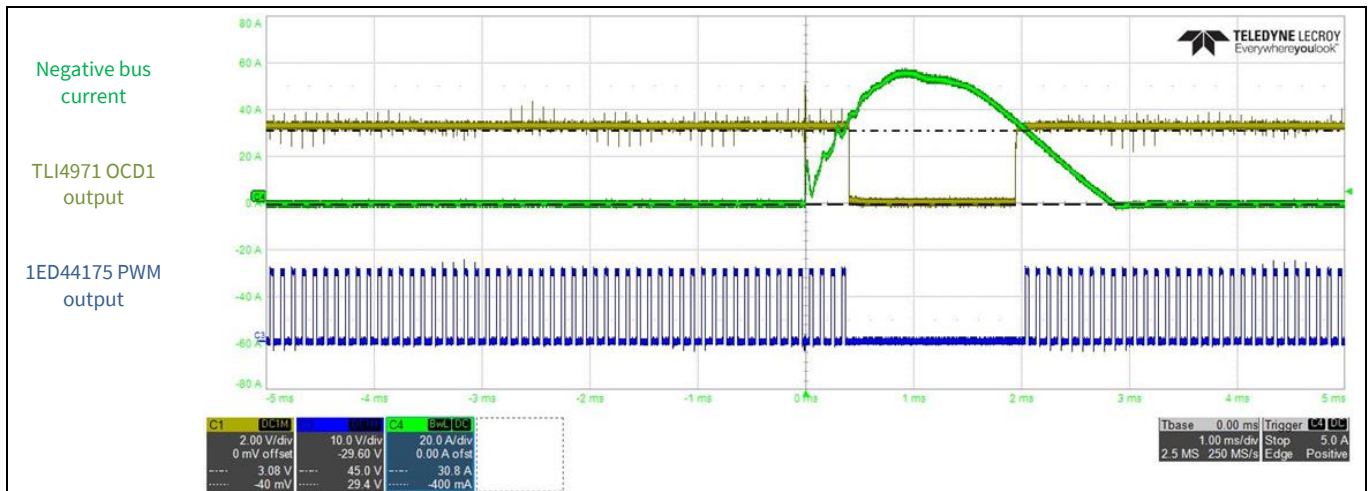

Figure 28 PFC overcurrent protection test

6.6 Negative temperature coefficient (NTC) thermistor characterization test

Table 11

Measured voltage across NTC (V)	PFC IGBT case temperature (°C)
1.699	21.2
1.485	31.6
1.201	41
0.958	50.7
0.83	56.7
0.621	68.9
0.471	79.9
0.345	92.7

Condition

- NTC #: B57703M502G40, TDK, 5 kΩ, mounted on the surface of PFC IGBT

Revision history

Revision history

Document version	Date	Description of changes
1.0	01-04-2022	Initial release
1.1	21-09-2022	Modified content
		Experimental data added

Trademarks

All referenced product or service names and trademarks are the property of their respective owners.

Edition 2022-09-21

Published by

Infineon Technologies AG

81726 Munich, Germany

© 2023 Infineon Technologies AG.

All Rights Reserved.

Do you have a question about this document?

Email: erratum@infineon.com

Document reference

UG-2021-42

IMPORTANT NOTICE

The information contained in this application note is given as a hint for the implementation of the product only and shall in no event be regarded as a description or warranty of a certain functionality, condition or quality of the product. Before implementation of the product, the recipient of this application note must verify any function and other technical information given herein in the real application. Infineon Technologies hereby disclaims any and all warranties and liabilities of any kind (including without limitation warranties of non-infringement of intellectual property rights of any third party) with respect to any and all information given in this application note.

The data contained in this document is exclusively intended for technically trained staff. It is the responsibility of customer's technical departments to evaluate the suitability of the product for the intended application and the completeness of the product information given in this document with respect to such application.

Please note that this product is not qualified according to the AEC Q100 or AEC Q101 documents of the Automotive Electronics Council.

WARNINGS

Due to technical requirements products may contain dangerous substances. For information on the types in question please contact your nearest Infineon Technologies office.

Except as otherwise explicitly approved by Infineon Technologies in a written document signed by authorized representatives of Infineon Technologies, Infineon Technologies' products may not be used in any applications where a failure of the product or any consequences of the use thereof can reasonably be expected to result in personal injury.