

# 800 Watt Medical



## Features

- 5 x 8.5 x 1.61 inches
- Approval to EN60601 Edition 3.1
- Dual Fusing
- Current Sharing Option
- Peak Power Capability
- Standard IEC60601-1-2 : 2014 (4th Edition)
- 5 Vdc Stand by
- 12 V fan output
- Power Good / Power Fail Signal
- Suitable for BF application
- Lesser than 1U high
- Having high voltage output range up to 58VDC
- N+1 redundant power supply
- Single wire current sharing
- Built in OR-ing diode / FET (- R suffix)

## Electrical Specifications

|                             |  |                               |
|-----------------------------|--|-------------------------------|
| Input Voltage               | 85–264 VAC/120–390 VDC, Universal  |                               |
| Input Frequency             | 47–63 Hz   |                               |
| Input Current               | 120 VAC: 8 A max.  | 240 VAC: 3.64 A max.          |
| Input Protection            | F16A/250 V in Live & Neutral both  |                               |
| No Load Power               | Typ 3W over entire input range with main output kept off using Remote ON/OFF   |                               |
| Inrush Current              | 240 VAC: 25 A max.   |                               |
| Leakage Current             | 400 $\mu$ A @ 240 VAC / 50 Hz  | Touch Current : < 100 $\mu$ A |
| Efficiency                  | 120 VAC: 88% Typical   | 240 VAC: 93%                  |
| Hold-up Time                | 120 VAC: 8 ms  | 240 VAC: 8 ms                 |
| Power Factor                | 120 VAC: 0.98  | 240 VAC: 0.95                 |
| Output Power                | Forced Air Cooling, up to 800W (U-Channel), up to 750W (Slotted Cover and Plain cover) ,<br>Peak 960W for 1ms. <b>*Ref. Derating curve</b> |                               |
| Line Regulation             | +/-0.5%  |                               |
| Load Regulation             | +/-1%  |                               |
| Transient Response          | < 10%, 50% to 100% load change, 50 Hz, 50% duty cycle, 0.1 A/ $\mu$ s, recovery time < 5 ms  |                               |
| Rise Time                   | <100ms   |                               |
| Set Point Tolerance         | +/-1%  |                               |
| Output Adjustability        | +/-3%  |                               |
| Over Current Protection     | 110% Typ, HiccUp Type, Autorecovery  |                               |
| Over Voltage Protection     | 114%, Latch Type, AC Power to be recycled for recovery   |                               |
| Short Circuit Protection    | Latch Type, AC Power to be recycled for recovery   |                               |
| Over Temperature Protection | 130-140°C primary heat sink, autorecovery  |                               |
| Current Share               | Upto 3 supplies can be connected in parallel (optional)  |                               |
| Switching Frequency         | PFC converter:Variable, 85 kHz typical<br>Resonant converter:Variable, 100 kHz typical   |                               |
| Operating Temperature       | -40 to +70°C, refer derating curve   |                               |
| Storage Temperature         | -40 to +85°C   |                               |
| Relative Humidity           | 95% Rh, noncondensing  |                               |
| Altitude                    | Operating: 16,000 ft.; Nonoperating: 40,000 ft.  |                               |
| MTBF                        | 3.37m Hours, Telcordia -SR332-issue 3  |                               |
| Isolation Voltage           | Input to Output 4245 VAC, Input to Earth 1625 VAC, Output to Earth 1500 VAC  |                               |

| Model Number | Type                | Voltage | Max. Load<br>(Convection) | Max. Load<br>(500 LFM)<br>(Fan Cooled) | Min. Load | Ripple <sup>1</sup> |
|--------------|---------------------|---------|---------------------------|--|-----------|---------------------|
| MVPS800-1012 | U-Channel           | 12 V    | 25 A                      | 33.33 A                                | 0.0 A     | 2%                  |
| MVPS800-1015 | U-Channel           | 15 V    | 25 A                      | 33.33 A                                | 0.0 A     | 2%                  |
| MVPS800-1024 | U-Channel           | 24 V    | 25 A                      | 33.33 A                                | 0.0 A     | 2%                  |
| MVPS800-1030 | U-Channel           | 30 V    | 20 A                      | 26.66 A                                | 0.0 A     | 2%                  |
| MVPS800-1048 | U-Channel           | 48 V    | 12.5 A                    | 16.66 A                                | 0.0 A     | 2%                  |
| MVPS800-1058 | U-Channel           | 58 V    | 10.34 A                   | 13.78 A                                | 0.0 A     | 2%                  |
| MVPS800-1S12 | U-Channel + Slotted | 12 V    | 17.5 A                    | 31.25 A                                | 0.0 A     | 2%                  |
| MVPS800-1S15 | U-Channel + Slotted | 15 V    | 17.5 A                    | 31.25 A                                | 0.0 A     | 2%                  |
| MVPS800-1S24 | U-Channel + Slotted | 24 V    | 17.5 A                    | 31.25 A                                | 0.0 A     | 2%                  |
| MVPS800-1S30 | U-Channel + Slotted | 30 V    | 14 A                      | 25 A                                   | 0.0 A     | 2%                  |
| MVPS800-1S48 | U-Channel + Slotted | 48 V    | 8.75 A                    | 15.625 A                               | 0.0 A     | 2%                  |
| MVPS800-1S58 | U-Channel + Slotted | 58 V    | 7.25 A                    | 12.93 A                                | 0.0 A     | 2%                  |
| MVPS800-1T12 | U-Channel + Cover   | 12 V    | 15 A                      | 31.25 A                                | 0.0 A     | 2%                  |
| MVPS800-1T15 | U-Channel + Cover   | 15 V    | 15 A                      | 31.25 A                                | 0.0 A     | 2%                  |
| MVPS800-1T24 | U-Channel + Cover   | 24 V    | 15 A                      | 31.25 A                                | 0.0 A     | 2%                  |
| MVPS800-1T30 | U-Channel + Cover   | 30 V    | 12 A                      | 25 A                                   | 0.0 A     | 2%                  |
| MVPS800-1T48 | U-Channel + Cover   | 48 V    | 7.5 A                     | 15.625 A                               | 0.0 A     | 2%                  |
| MVPS800-1T58 | U-Channel + Cover   | 58 V    | 6.2 A                     | 12.93 A                                | 0.0 A     | 2%                  |

To order product with the redundancy diode option please add the suffix-R to your required part number. For Example - MVPS800-1012-R

| Pin Connections      |        |         |
|----------------------|--------|---------|
| J1                   | 1      | AC LINE |
|                      | 2      | NEUTRAL |
|                      | 3      | EARTH   |
| J2                   | J2-A   | +VE     |
|                      | J2-B   | -VE     |
| J3                   | Pin 1  | GND     |
|                      | Pin 2  | 5V AUX  |
|                      | Pin 3  | PGPF    |
|                      | Pin 4  | VS -    |
|                      | Pin 5  | VS +    |
|                      | Pin 6  | GND     |
|                      | Pin 7  | RMT     |
|                      | Pin 8  | CL2     |
|                      | Pin 9  | CL1     |
|                      | Pin 10 | LS      |
| J10,J11 (FAN OUTPUT) | Pin 1  | + VE    |
|                      | Pin 2  | - VE    |



Innovations in Power

## Notes

1. For Ripple measurement minimum output power requirement is 25 W.  
Ripple is peak to peak with 20 MHz bandwidth and 10  $\mu$ F (Electrolytic capacitor) in parallel with a 0.1  $\mu$ F capacitor at rated line voltage and load ranges.
2. Combined output power of main output, fan supply and standby supply shall not exceed max. power rating.
3. Standby output voltage 5 V/ 1.5A(convection) with tolerance including set point accuracy, line and load regulation is +/-10%.  
Ripple and noise is less than 5%.
4. Specifications are for nominal input voltage, 25°C unless otherwise stated.
5. PSU is supplied with J3, pin-6 and pin-7 shorted to enable main output without remote on/off feature.
6. Fan supply output voltage is 12V/500mA with regulation band+/-30 % and Ripple is less than 10%. To get 12V Fan supply output voltage, minimum 10 % load on Main output voltage is required.

## Mechanical Specifications

|                          |  |
|--------------------------|--|
| AC Input Connector (J1)  | TE Connectivity: NC6-P107-03   |
| DC Output Connector (J2) | 6–32 inches Screw Pan HD<br>Mating: Designed to accept Ring Tongue Terminal AMP : 8-31886-1, wherein one 16 AWG(max) wire can be crimped.<br>Note : One Ring Tongue Terminal with 16 AWG is recommended for current upto 11A only. Use multiple tongue terminals with wire for more current. |
| Signal Connector (J3)    | Molex: 22–23–2101<br>Mating: 22–01–2107; Pins: 08–50–0113  |
| J10, J11 (Fan Output)    | Make : TE Connectivity AMP Connectors<br>Description: CONN HEADER VERT 2POS 2.54MM<br>MPN : 640456-2<br>Mating : 3-641535-2 / TE Connectivity AMP Connectors OR 0022013027 / MOLEX with crimping 08-50-0114 / MOLEX  |
| Dimensions               | 5.0 x 8.5 x 1.61 inches<br>(127 x 216 x 41 mm)   |
| Weight                   | 1.1 kg   |

## EMC

| Parameter                          | Conditions/Description             | Criteria  |
|------------------------------------|------------------------------------|---|
| Conducted Emissions                | EN 55011-B,CISPR22-B, FCC PART15-B | Class B   |
| Radiated Emissions                 | EN 55011                           | Class A (Class B with External king core K5B RC 25x12x15-M or equivalent) |
| Input Current Harmonics            | EN 61000-3-2                       | Class A   |
| Voltage Fluctuation and Flicker    | EN 61000-3-3                       | Complies  |
| ESD Immunity                       | EN 61000-4-2                       | A   |
| Radiated Field Immunity            | EN 61000-4-3                       | A   |
| Electrical Fast Transient Immunity | EN 61000-4-4                       | A   |
| Surge Immunity                     | EN 61000-4-5                       | A   |
| Conducted Immunity                 | EN 61000-4-6                       | A   |
| Magnetic Field Immunity            | EN 61000-4-8                       | A   |
| Voltage dips, interruptions        | EN 61000-4-11                      | A & B   |

## Safety

|                       |   |
|-----------------------|---|
| CE Mark               | Complies with LVD Directive   |
| Approval Agency       | Nemko, UL, C-UL   |
| Safety Standard(s)    | EN60601-1, IEC 60601-1 (ed.3),ANSI/AAMI ES 60601-1, CSA C22.2 No. 60601-1                                       |
| Safety File Number(s) | UL Certificate No : 2019-02-21-E173812<br>CB Test Certificate No : NO105338<br>Nemko Certificate No : P19223365 |

## Signal(s)

Power Good / Power Fail Signal

The delay is 0.1 s to 0.5 s

value at AC Power off

Power Good : Is a TTL signal which goes high after main output reaches 90% of its set value.

Power Fail : The same signal goes low at least 1ms before main output falls to 90% of set

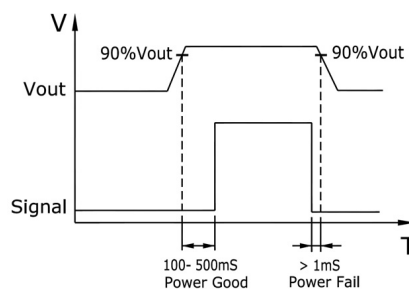

Remote Sense

Compensates for 200 mV drop

Remote on/off

Pin 6 & Pin 7 of J3 can be used for Remote on/off.

Shorting Pin 6 to Pin 7 enables main output while keeping the pins open disables main output

Note: - Provision of Inhibit Remote ON/OFF is available. +5V at Pin 7 will switch off the main output.

OCP limit set

Pin 8 & Pin 9 of J3 must be left open

## Derating Curve

Power Derating w.r.t Input

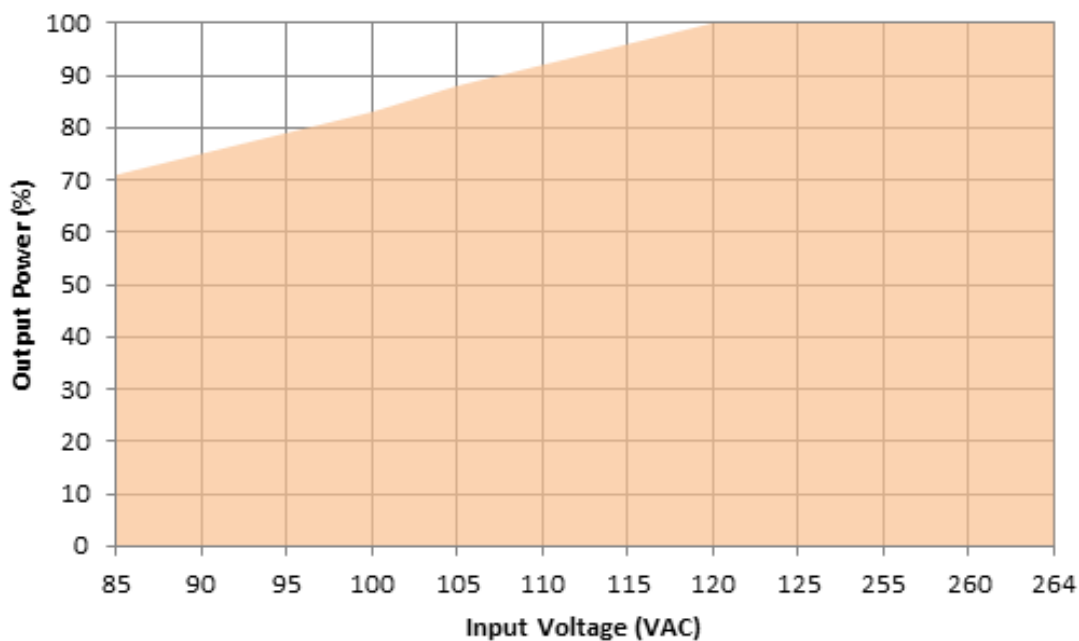

## Derating Curve

### Derating Curve 12 V

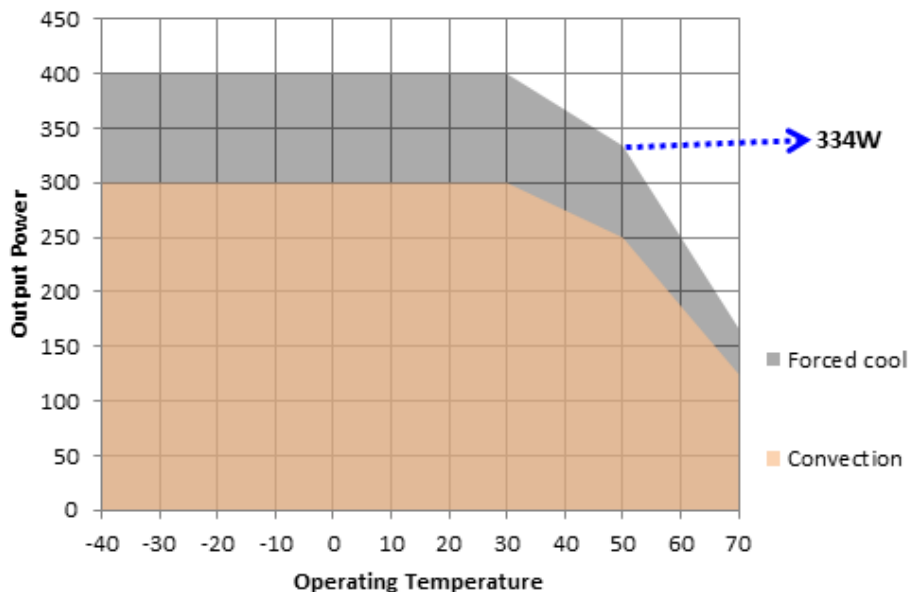

Convection load: 300W up to 30 °C  
 De-rate between 30-50 °C @ 0.833% per °C  
 De-rate above 50 °C @ 2.5% per °C

Forced air cooled load : 400W up to 30°C  
 De-rate between 30-50 °C @ 0.825% per °C  
 De-rate above 50 °C @ 2.5% per °C

### Derating Curve 12 V for slotted cover

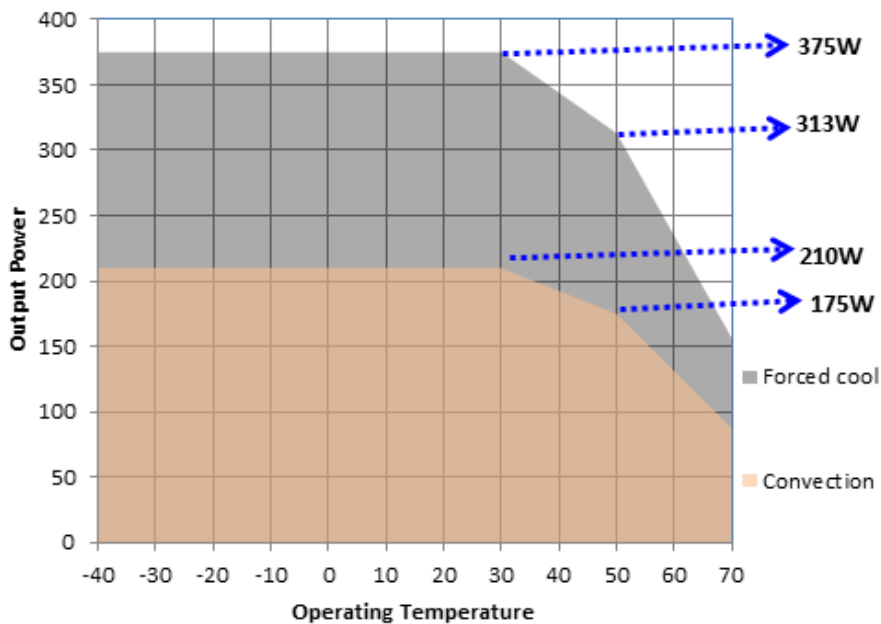

Convection load: 210W up to 30 °C  
 De-rate between 30-50 °C @ 0.833% per °C  
 De-rate above 50 °C @ 2.5% per °C

Forced air cooled load : 375W up to 30°C  
 De-rate between 30-50 °C @ 0.825% per °C  
 De-rate above 50 °C @ 2.5% per °C



Innovations in Power

39-DE60-40552-002 / A4

## Derating Curve

### Derating Curve 12 V for plain cover

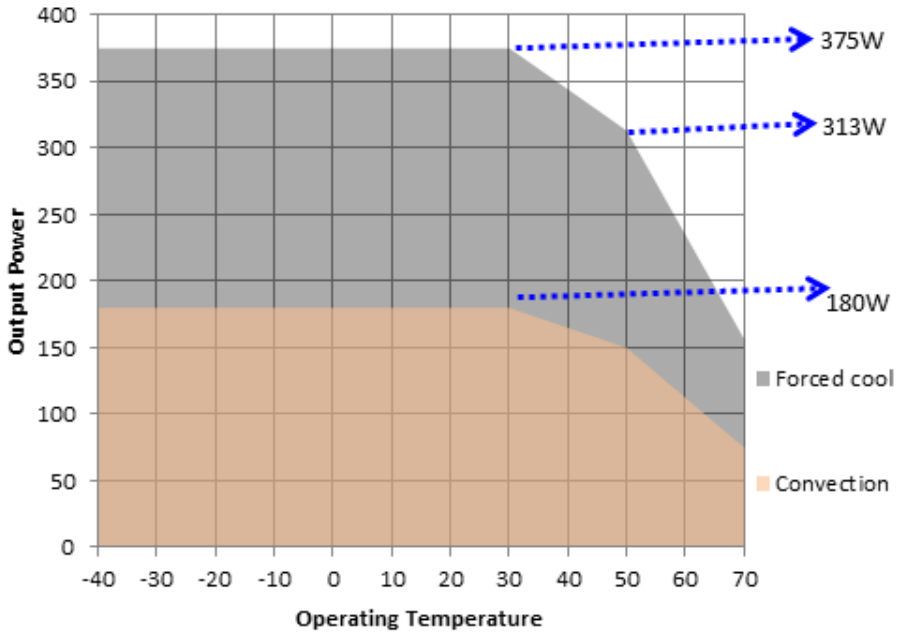

Convection load: 180W up to 30 °C  
 De-rate between 30-50 °C @ 0.833% per °C  
 De-rate above 50 °C @ 2.5% per °C

Forced air cooled load : 375W up to 30°C  
 De-rate between 30-50 °C @ 0.825% per °C  
 De-rate above 50 °C @ 2.5% per °C

### Derating Curve 15 V

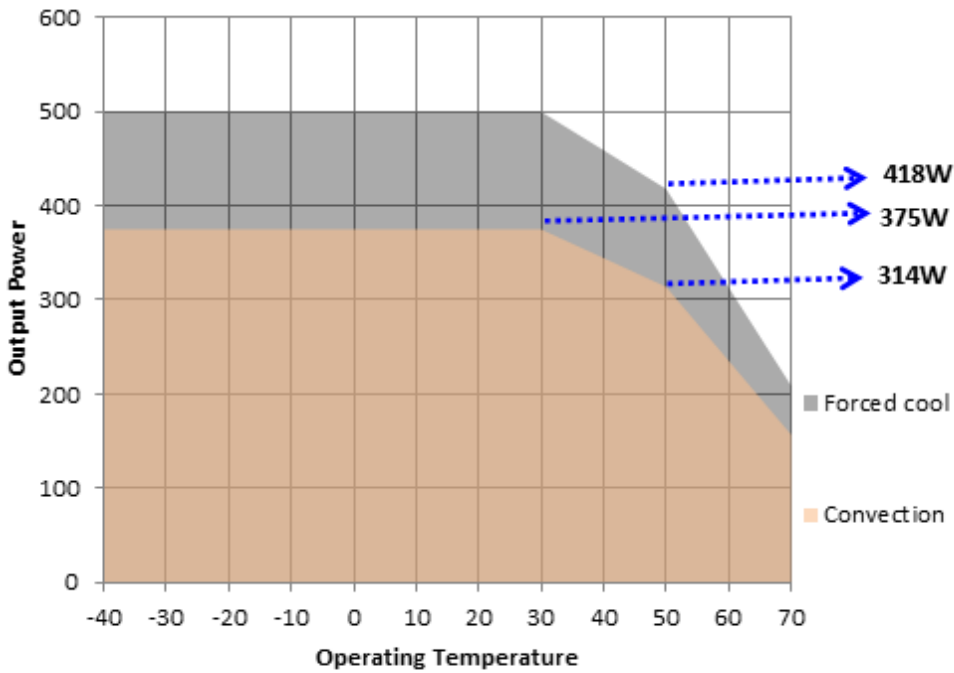

Convection load: 375W up to 30 °C  
 De-rate between 30-50 °C @ 0.8133% per °C  
 De-rate above 50 °C @ 2.5% per °C

Forced air cooled load : 500W up to 30°C  
 De-rate between 30-50 °C @ 0.82% per °C  
 De-rate above 50 °C @ 2.5% per °C

## Derating Curve

### Derating Curve 15 V slotted cover

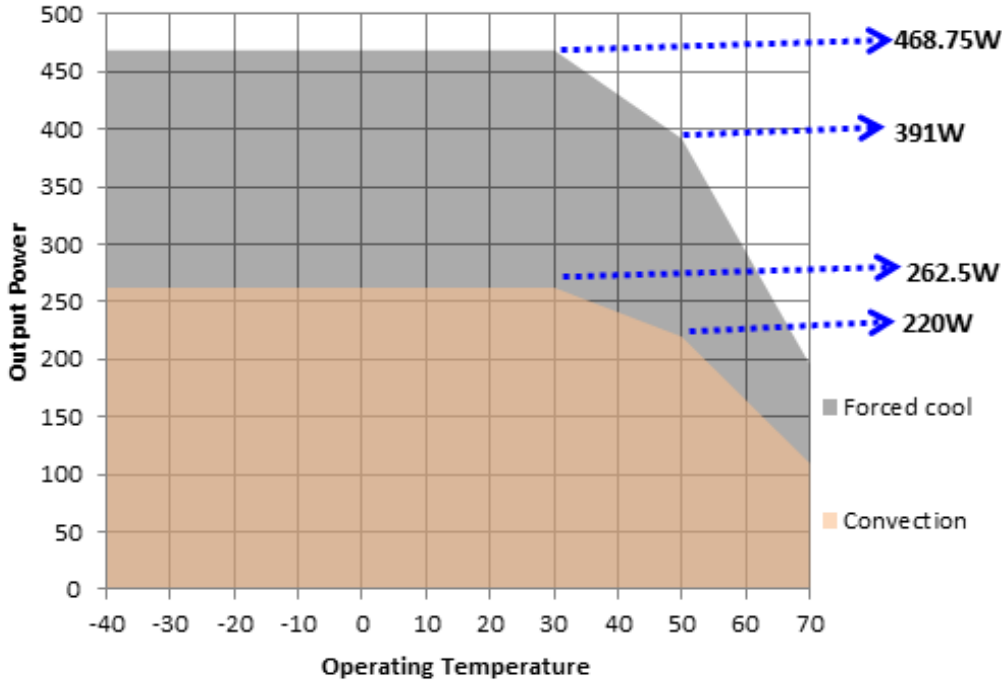

Convection load: 262.5W up to 30 °C  
 De-rate between 30-50 °C @ 0.8133% per °C  
 De-rate above 50 °C @ 2.5% per °C

Forced air cooled load : 468.75W up to 30°C  
 De-rate between 30-50 °C @ 0.82% per °C  
 De-rate above 50 °C @ 2.5% per °C

### Derating Curve 15 V plain cover

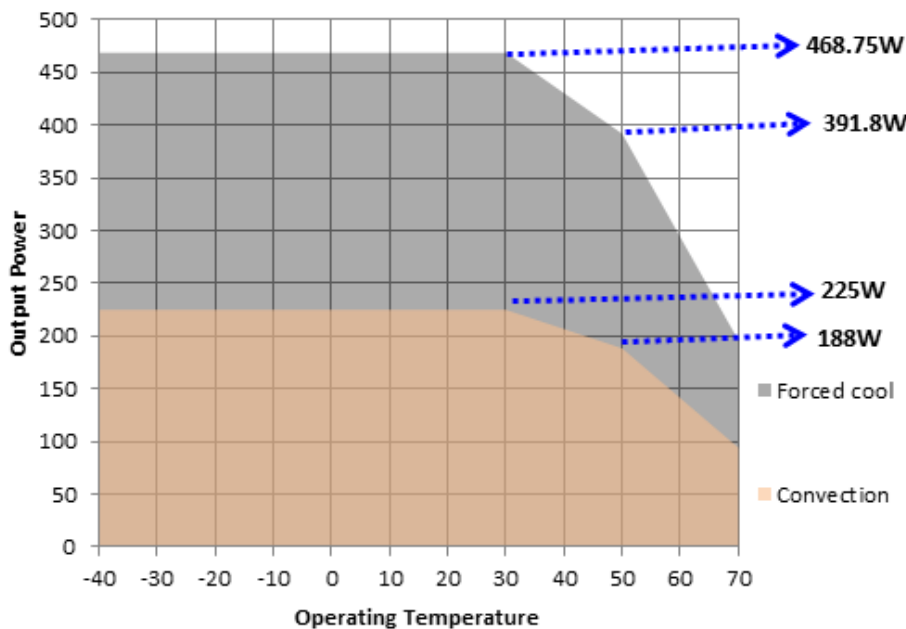

Convection load: 225W up to 30 °C  
 De-rate between 30-50 °C @ 0.8133% per °C  
 De-rate above 50 °C @ 2.5% per °C

Forced air cooled load : 468.75W up to 30°C  
 De-rate between 30-50 °C @ 0.82% per °C  
 De-rate above 50 °C @ 2.5% per °C





## Derating Curve

### Derating Curve 24 V & above

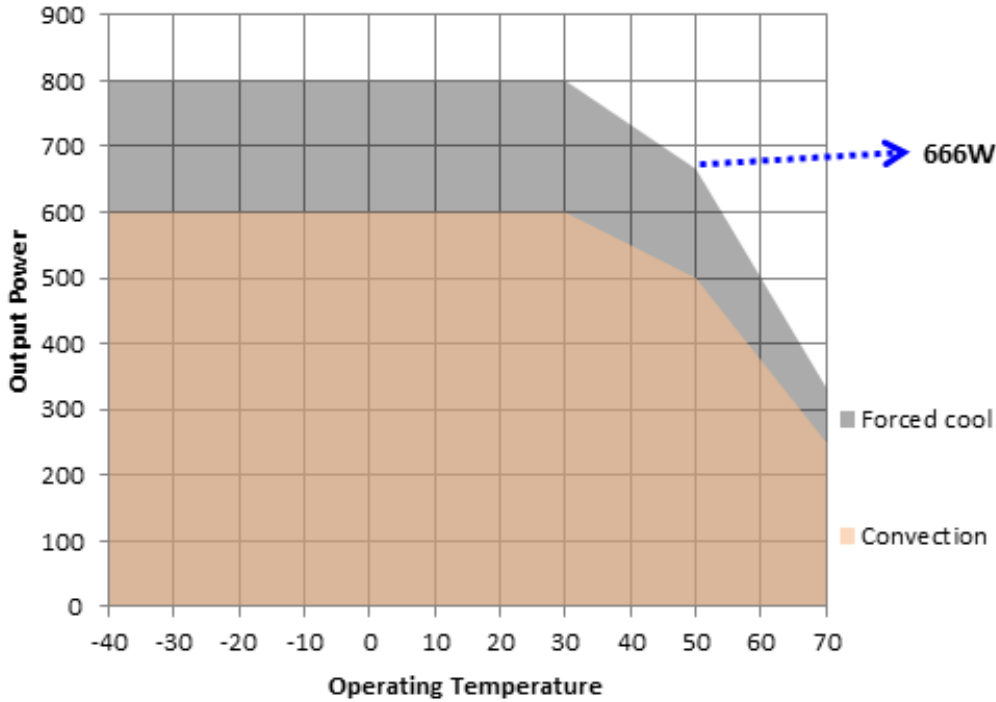

Convection load: 600W up to 30 °C  
 De-rate between 30-50 °C @ 0.833% per °C  
 De-rate above 50 °C @ 2.5% per °C

Forced air cooled load : 800W up to 30°C  
 De-rate between 30-50 °C @ 0.8375% per °C  
 De-rate above 50 °C @ 2.5% per °C

### Derating Curve 24 V & above for slotted cover

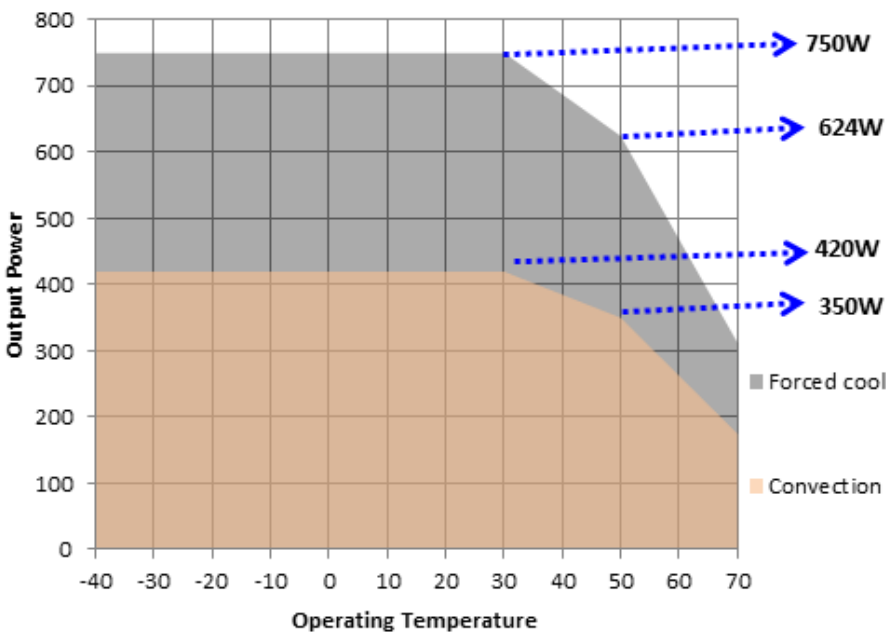

Convection load: 420W up to 30 °C  
 De-rate between 30-50 °C @ 0.833% per °C  
 De-rate above 50 °C @ 2.5% per °C

Forced air cooled load : 750W up to 30°C  
 De-rate between 30-50 °C @ 0.8375% per °C  
 De-rate above 50 °C @ 2.5% per °C

## Derating Curve

Derating Curve 24 V & above for plain cover

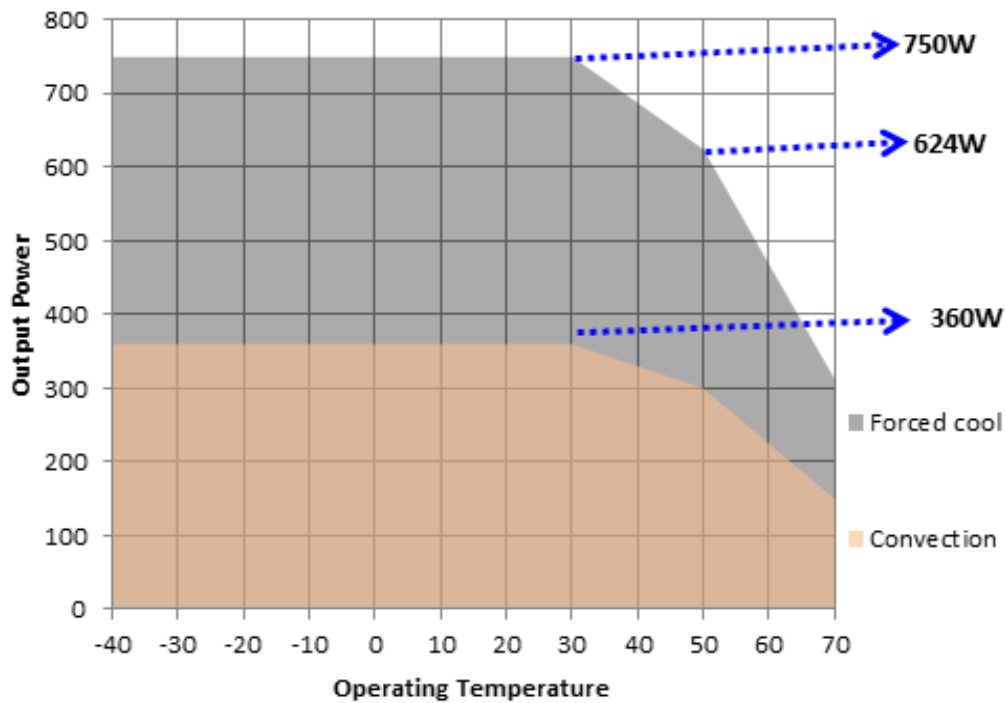

Convection load: 360W up to 30 °C  
 De-rate between 30-50 °C @ 0.833% per °C  
 De-rate above 50 °C @ 2.5% per °C

Forced air cooled load : 750W up to 30°C  
 De-rate between 30-50 °C @ 0.8375% per °C  
 De-rate above 50 °C @ 2.5% per °C



# Mechanical Drawing

## Option - 1 (U-Channel)

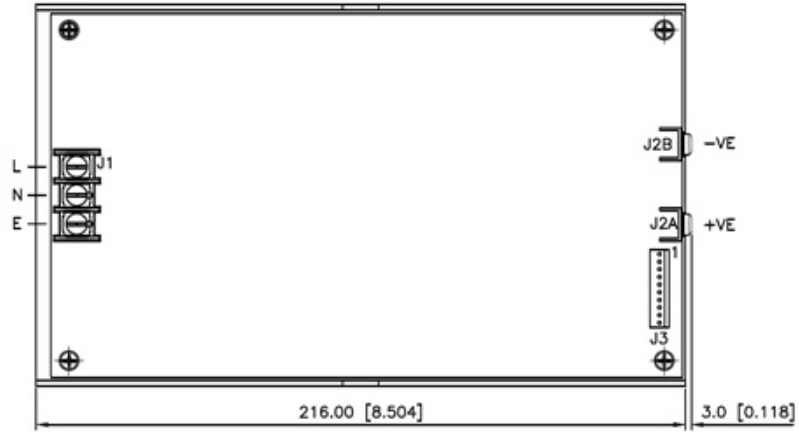
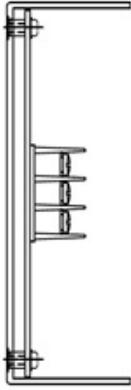

TOP VIEW

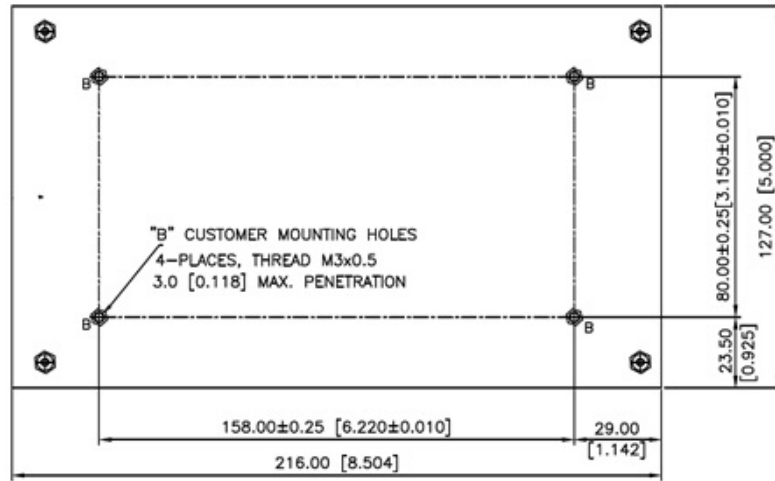

BOTTOM VIEW

MECHANICAL OUTLINE DIMENSIONS  
 ALL DIMENSIONS ARE IN MM [INCHES]  
 GEN.TOLERANCE:±1.0 MM [±0.04]

# Mechanical Drawing

## Option - 2 (Slotted Cover)

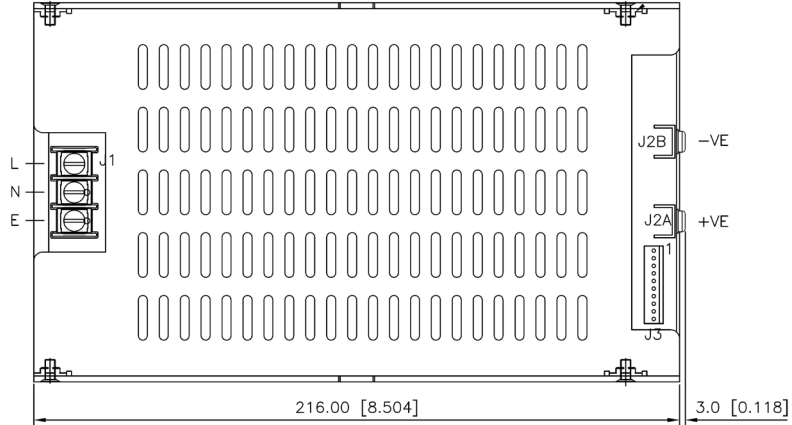
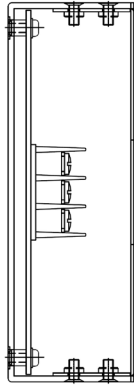

TOP VIEW

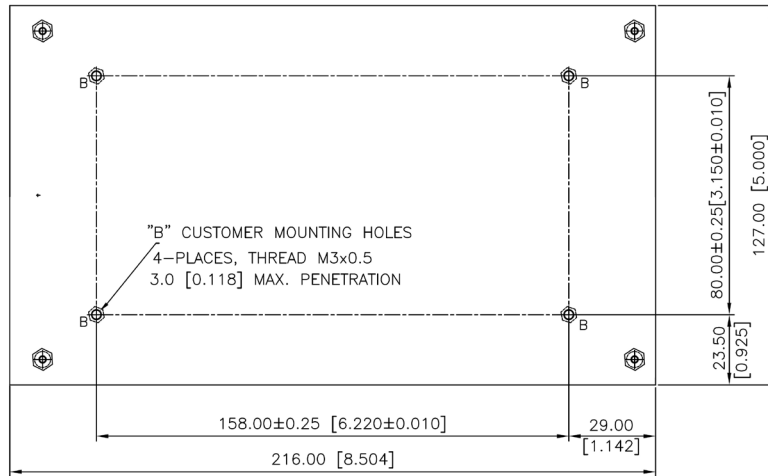

BOTTOM VIEW

MECHANICAL OUTLINE DIMENSIONS  
 ALL DIMENSIONS ARE IN MM [INCHES]  
 GEN.TOLERANCE:±1.0 MM [±0.04]



# Mechanical Drawing

## Option - 3 (Plain Cover)

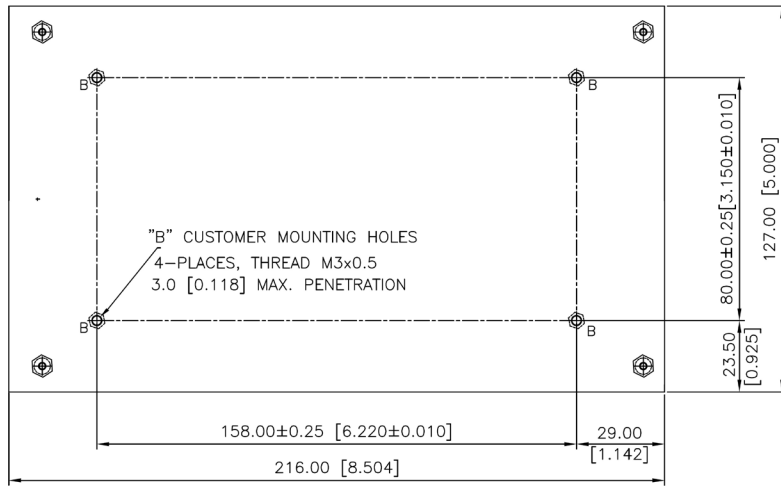
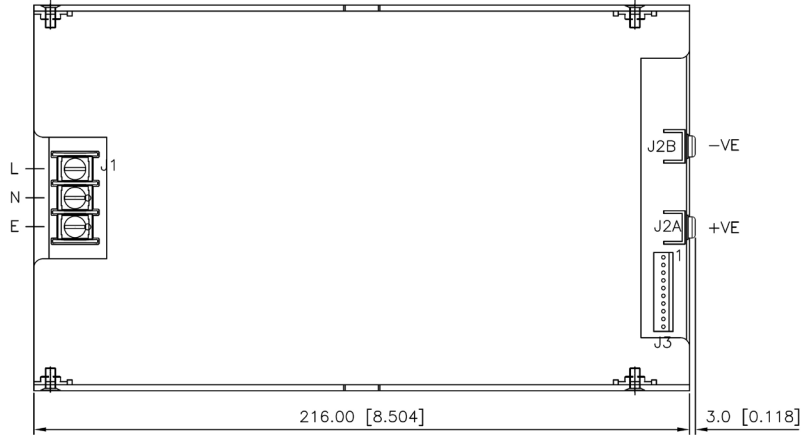
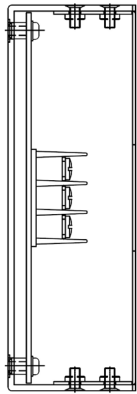

MECHANICAL OUTLINE DIMENSIONS  
ALL DIMENSIONS ARE IN MM [INCHES]  
GEN.TOLERANCE:±1.0 MM [±0.04]

## Installation instruction for current sharing:

During the installation and setup of parallel supplies in a system it is important that a single remote sense point be used for all the supplies. The remote sense voltage between the supplies must be adjusted to within 1% to ensure the supplies are inside the 1% capture window. If the supplies are not initially adjusted inside the capture window the supplies will not current share satisfactorily.

## Set-Up Procedures:

1. Connect load cables to the outputs of each supply.
2. Connect the remote sense lines to the load in twisted style . (A common remote sense point must be used for all the supplies in parallel).
3. Connect all the "LS" signal(Pin 10) on the J3 connector between the supplies.
4. Adjust remote sense voltage of each supply to within 1% of rated output voltage or readjust to required set point. (Adjustment to be done with all other parallel supplies off).
5. Current sharing between the supplies can be verified by monitoring the output current of each supply with a hall effect DC current probe. The supplies should share to within 10% of the total load current. The maximum recommended power output for three units in parallel would be 2160W.
6. The current share circuit has a capture window voltage of +/- 1% of the rated output voltage. If the output remote sense voltage of one of the supplies is adjusted outside the 1% window the supplies will not current share satisfactorily.

## CURRENT SHARING BLOCK DIAGRAM

