

MDSTB 2,5/15-G1

Order No.: 1762826

The figure shows a 10-position version of the product

<http://eshop.phoenixcontact.de/phoenix/treeViewClick.do?UID=1762826>Header, Nominal current: 10 A, Nom. voltage: 250 V, Pitch: 5 mm,
Number of positions: 15, Color: green, Assembly: Soldering

Commercial data

EAN	4017918031404
Pack	50 pcs.
Customs tariff	85366990
Weight/Piece	0.0268 KG
Catalog page information	Page 261 (CC-2009)

Product notes

WEEE/RoHS-compliant since:
01/01/2003

<http://www.download.phoenixcontact.com>
Please note that the data given here has been taken from the online catalog. For comprehensive information and data, please refer to the user documentation. The General Terms and Conditions of Use apply to Internet downloads.

Technical data

Dimensions / positions

Pitch	5 mm
Dimension a	70 mm
Number of positions	15
Pin dimensions	1 x 1 mm
Hole diameter	1.4 mm

Technical data

Insulating material group	I
Rated surge voltage (III/3)	4 kV
Rated surge voltage (III/2)	4 kV
Rated surge voltage (II/2)	4 kV
Rated voltage (III/2)	320 V
Rated voltage (II/2)	630 V
Connection in acc. with standard	EN-VDE
Nominal current I_N	10 A
Nominal voltage U_N	250 V
Maximum load current	10 A
Insulating material	PA
Inflammability class acc. to UL 94	V0

Certificates / Approvals



Certification

CB, CSA, CUL, GOST, UL, VDE-PZI

CSA

Nominal voltage U_N	300 V
Nominal current I_N	10 A

CUL

Nominal voltage U_N	300 V
Nominal current I_N	10 A

UL

Nominal voltage U_N	300 V
Nominal current I_N	10 A

Accessories

Item	Designation	Description
Assembly		
1755477	MSTB-BL	Keying cap, for forming sections, plugs onto header pin, green insulating material
Marking		
0804183	SK 5/3,8:FORTL.ZAHLEN	Marker card, printed horizontally, self-adhesive, 12 identical decades marked 1-10, 11-20 etc. up to 91-(99)100, sufficient for 120 terminal blocks
Plug/Adapter		
1734401	CR-MSTB	Coding section, inserted into the recess in the header or the inverted plug, red insulating material

Additional products

Item	Designation	Description
Assembly		
1909346	FKCT 2,5/15-ST	Plug component, Nominal current: 12 A, Nom. voltage: 250 V, Pitch: 5 mm, Number of positions: 15, Connection type: Spring-cage conn., Color: green
General		
1910487	FKC 2,5/15-ST	Plug component, Nominal current: 12 A, Nom. voltage: 250 V, Pitch: 5 mm, Number of positions: 15, Connection type: Spring-cage conn., Color: green
1909841	FKCVR 2,5/15-ST	Plug component, Nominal current: 12 A, Nom. voltage: 250 V, Pitch: 5 mm, Number of positions: 15, Connection type: Spring-cage conn.
1910160	FKCVW 2,5/15-ST	Plug component, Nominal current: 12 A, Nom. voltage: 250 V, Pitch: 5 mm, Number of positions: 15, Connection type: Spring-cage conn.
1779547	FRONT-MSTB 2,5/15-ST	Plug component, Nominal current: 12 A, Nom. voltage: 250 V, Pitch: 5 mm, Number of positions: 15, Connection type: Screw connection, Color: green
1754708	MSTB 2,5/15-ST	Plug component, Nominal current: 12 A, Nom. voltage: 250 V, Pitch: 5 mm, Number of positions: 15, Connection type: Screw connection, Color: green
1759389	MSTB 2,5/15-STZ	Plug component, Nominal current: 12 A, Nom. voltage: 250 V, Pitch: 5 mm, Number of positions: 15, Connection type: Screw connection, Color: green

1765904	MSTBP 2,5/15-ST	Plug component, Nominal current: 12 A, Nom. voltage: 250 V, Pitch: 5 mm, Number of positions: 15, Connection type: Screw connection, Color: green
1779961	MSTBT 2,5/15-ST	Plug component, Nominal current: 12 A, Nom. voltage: 250 V, Pitch: 5 mm, Number of positions: 15, Connection type: Screw connection, Color: green
1792142	MVSTBR 2,5/15-ST	Plug component, Nominal current: 12 A, Nom. voltage: 250 V, Pitch: 5 mm, Number of positions: 15, Connection type: Screw connection, Color: green
1792650	MVSTBW 2,5/15-ST	Plug component, Nominal current: 12 A, Nom. voltage: 250 V, Pitch: 5 mm, Number of positions: 15, Connection type: Screw connection, Color: green
1768888	SMSTB 2,5/15-ST	Plug component, Nominal current: 12 A, Nom. voltage: 250 V, Pitch: 5 mm, Number of positions: 15, Connection type: Screw connection, Color: green

Diagrams/Drawings

Drilling plan/solder pad geometry

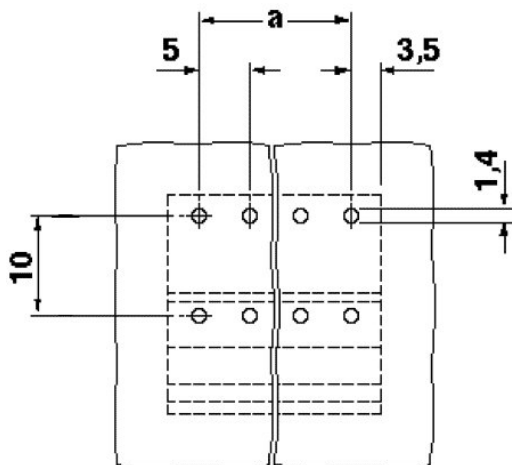

Dimensioned drawing

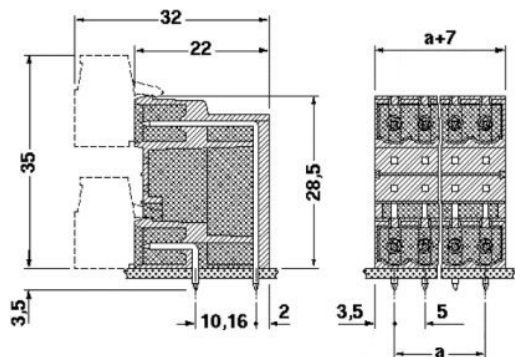

Address

PHOENIX CONTACT Inc., USA
586 Fulling Mill Road
Middletown, PA 17057, USA
Phone (800) 888-7388
Fax (717) 944-1625
<http://www.phoenixcon.com>



© 2010 Phoenix Contact
Technical modifications reserved;