

Sensus™ High Density LED Series

Pure White Targeted COB Arrays Below the Black Body Locus (BBBL)



Table of Contents

- Technology Overview2
- Chromaticity Bins3
- Part Number Nomenclature 4
- Ordering Part Number. 5
- Operating Characteristics ..7
- Optical and Electrical Character-
istics.....9
- Spectra 12
- Mechanical Dimensions .. 13
- Packaging Information ... 13
- Handling Notes 17

Features:

- Matching the human perception of “Pure white” light
- Designed to provide the look and feel of ceramic metal halide lights
- Wide luminous range from 1,500lm to 7,800lm
- 3000K and 3500K, 80 CRI and 90 CRI standard
- 3 SDCM color binning accuracy
- Excellent optical emission uniformity and color over angle consistency
- Exceptional long term color stability
- Package thermal conductivity more than twice the industry average
- Environmentally friendly: RoHS and REACH compliant
- UL Recognized, File # E465703



Applications

- Retail Shop Lighting
- Halogen replacement LED lamps
- Spotlights/Track Lights
- Hospitality Lighting
- CMH replacement LED lamps
- Architectural and Specialty

Technology Overview

Luminus Chip-on-Board (COB) LED series offers a complete lighting class solution designed for high performance illumination applications. The selection covers a wide lumen range from less than 400lm to over 10,000lm, all major color temperatures and can deliver color rendering greater than 97 at 2700K and 3000K and R9 equal to 95. These breakthroughs allow illumination engineers and designers to develop lighting solutions with maximum efficacy, brightness and overall quality.

Reliability

Designed from the ground up, the Sensus™ COB LED is one of the most reliable light sources in the world today. Having passed a rigorous suite of environmental and mechanical stress tests, including mechanical shock, vibration, temperature cycling and humidity. Only then are the devices qualified for use in a wide range of lighting application including some of the most demanding commercial applications. Delivered with fully qualified LM-80 test data and TM-21 lifetime results that certify lumen maintenance at 50,000 hours or more, Sensus™ COB LEDs are ready for the toughest challenges.

UL Recognized Compliance

Sensus COB arrays are tested in accordance with ANSI/UL 8750 to ensure safe operation for their intended applications.

REACH & RoHS Compliance

All LED products manufactured by Luminus are REACH and RoHS compliant and free of hazardous materials, including lead and mercury.

Understanding Luminus COB LED Test Specifications

Every Luminus LED is fully tested to ensure it meets the high quality standards customers have come to expect from Luminus' products.

Traceability

Each Sensus COB LED is marked with a 2D bar code that contains a unique serial number. With this serial number, Luminus has the ability to provide customers with actual test data measurements for a specific LED. In addition, the 2D bar code is linked to manufacturing date codes that enables traceability of production processes and materials.

Chromaticity Bin Range

Chromaticity binning delivers color consistency for every order. Standard products are delivered with a 3-step MacAdam ellipse. This ensures color performance matching in the application. These tightly controlled, small distribution bins provide customers predictable, repeatable colors.

Testing Temperature

Sensus™ COB products are measured at temperatures typical for the LED operating in the fixture. Each device is tested at 85°C junction temperature eliminating the need to scale data sheet specifications to real world situations.

Chromaticity Bin Structure

Chromaticity Bins: 1931 CIE Curve



Sensus™ LED White Chromaticity Bins

The following tables describe the ANSI bin center points, the orientation angle for the MacAdam ellipse (θ°), and the maximum radii for the ellipses. The ANSI Bin is provided for reference.

Description	CCT	Center Point		3-step Bin		
		CIE _x	CIE _y	θ (°)	a	b
Standard	3000K	0.4252	0.3877	53.6	0.00834	0.00408
Xtreme		0.4210	0.3720	53.2		
Standard	3500K	0.4067	0.3845	54	0.00927	0.00414
Xtreme		0.3980	0.3660	54		

*Note: Luminus maintains a +/- 0.005 tolerance on chromaticity (CIE_x and CIE_y) measurements.

Product Ordering and Shipping Part Number Nomenclature

All Sensus LED products are packaged and labeled with part numbers as outlined in the table on page 5. Luminus will include any smaller chromaticity bin that is contained in the larger bin as part of the ordered part. When shipped, each package will contain only a single flux and chromaticity bin. The part number designation is as follows:

CHM — XX — 30 — XX — XX — QQPP — FG — W

Product Family	Light Emitting Surface Diameter ¹	Color Temperature	Color Rendering Index (CRI)	Voltage (typical) ²	Package Configurator ³	Flux Bin	Chromaticity Bin ⁴
CHM: Chip on Board	XX: LES Diameter (mm) Approximate	3000K	CRI	Volts	XH22/XH24 (Basic package)	Lumens	See page 3 for bins

Note 1: XX nomenclature corresponds to the following:

- 6 = 6.3mm
- 9 = 9mm
- 11 = 11mm
- 14 = 13.5mm

Note 2: All products have 36V standard except for CHM-6 which has 27V

Note 3: XH22 is the standard Sensus and a standard package configurator
XH24 is the standard Xtreme Sensus and a standard package configurator

Color Temperature, CRI and R9 Values

Color Temperatures	XX Value	CRI	R9
3000K, 3500K	80	>80	>0
	90	>90	>50

Note: Luminus part numbers may be accompanied by prefixes or suffixes. The most common is the "Rev01" suffix indicating a part is fully released and carries a full warranty. These additional characters may appear on shipping labels, packing slips and invoices. In all Junctions the basic part number described above will always be included.

Sensus™ High Density LED Series Part Numbers (Typical)

The following tables describe products with typical flux and minimum flux measured at typical currents and specified at 85°C. The values at 25°C are calculated and shown for reference only. All products are measured and specified at 85°C junction temperature.

Output Flux (lm)			Typ. Current (mA)	Ordering Part Number
Typ. (85°C)	Min. (85°C)	Typ. (calculated) (25°C)		3-step MacAdam Ellipse
1,510	1,405	1,630	480	CHM-6-30-80-27-XH22-F3-3
1,270	1,180	1,370		CHM-6-30-90-27-XH22-F3-3
1,555	1,445	1,675		CHM-6-35-80-27-XH22-F3-3
1,295	1,205	1,400		CHM-6-35-90-27-XH22-F3-3
3,040	2,825	3,280	720	CHM-9-30-80-36-XH22-F3-3
2,555	2,375	2,755		CHM-9-30-90-36-XH22-F3-3
3,130	2,910	3,375		CHM-9-35-80-36-XH22-F3-3
2,610	2,425	2,810		CHM-9-35-90-36-XH22-F3-3
4,695	4,365	5,065	1,050	CHM-11-30-80-36-XH22-F3-3
3,945	3,670	4,260		CHM-11-30-90-36-XH22-F3-3
4,830	4,495	5,210		CHM-11-35-80-36-XH22-F3-3
4,030	3,750	4,345		CHM-11-35-90-36-XH22-F3-3
7,630	7,095	8,230	1,750	CHM-14-30-80-36-XH22-F3-3
6,415	5,970	6,925		CHM-14-30-90-36-XH22-F3-3
7,855	7,310	8,480		CHM-14-35-80-36-XH22-F3-3
6,545	6,090	7,065		CHM-14-35-90-36-XH22-F3-3

*Note: Luminus maintains a +/- 6% tolerance on flux measurements.

Luminus maintains a +/- 2% tolerance on CRI measurements.

Xtreme Sensus™ High Density LED Series Part Numbers (Typical)

The following tables describe products with typical flux and minimum flux measured at typical currents and specified at 85°C. The values at 25°C are calculated and shown for reference only. All products are measured and specified at 85°C junction temperature.

Output Flux (lm)			Typ. Current (mA)	Ordering Part Number
Typ. (85°C)	Min. (85°C)	Typ. (calculated) (25°C)		3-step MacAdam Ellipse
1,095	1,015	1,180	480	CHM-6-30-90-27-XH24-F3-3
1,115	1,040	1,205		CHM-6-35-90-27-XH24-F3-3
2,205	2,045	2,375	720	CHM-9-30-90-36-XH24-F3-3
2,250	2,090	2,420		CHM-9-35-90-36-XH24-F3-3
3,400	3,165	3,670	1,050	CHM-11-30-90-36-XH24-F3-3
3,475	3,235	3,745		CHM-11-35-90-36-XH24-F3-3
5,530	5,145	5,970	1,750	CHM-14-30-90-36-XH24-F3-3
5,640	5,250	6,090		CHM-14-35-90-36-XH24-F3-3

*Note: Luminus maintains a +/- 6% tolerance on flux measurements.

Luminus maintains a +/- 2% tolerance on CRI measurements.

CHM-6 Operating Characteristics¹

Optical and Electrical Characteristics

Parameter	Symbol	Minimum	Typical	Maximum	Unit
Forward Current ²	I_f		480	720	mA
Forward Voltage ³	V_f	25.5	27.4	29.4	V
Power			13.2	21	W
Operating Junction Temperature ⁴	T_c			105	°C
Light Emitting Surface Diameter	LES		6.3		mm
Thermal Resistance (junction-to-Junction)	Θ_{jc}		-		°C/W
Junction Temperature	T_j			140	°C
Viewing Angle			120		Degree

CHM-9 Operating Characteristics¹

Optical and Electrical Characteristics

Parameter	Symbol	Minimum	Typical	Maximum	Unit
Forward Current ²	I_f		720	1,080	mA
Forward Voltage ³	V_f	34.5	36.5	38.5	V
Power			26.3	42	W
Operating Junction Temperature ⁴	T_c			105	°C
Light Emitting Surface Diameter	LES		9.0		mm
Thermal Resistance (junction-to-Junction)	Θ_{jc}		-		°C/W
Junction Temperature	T_j			140	°C
Viewing Angle			120		Degree

Operating Characteristics Notes

- Note 1: Ratings are based on operation at a constant junction temperature of $T_j = 85^\circ\text{C}$.
- Note 2: To prevent damage refer to operating conditions and derating curves for appropriate maximum operating conditions
- Note 3: Forward voltage range is specified at a typical current drive condition and $T_j = 85^\circ\text{C}$.
- Note 4: CHM COB LEDs are designed for operation up to an absolute maximum forward drive current as specified above. Refer to the current vs. Junction temperature derating curves for further information.
- Note 5: Caution must be taken not to stare at the light emitted from these LEDs. Under special circumstances, the high intensity could damage the eye.
- Note 6: While there is no minimum current rating for any device, it is recommended to not operate device below 20% of typical current values to prevent uneven light emission.

CHM-11 Operating Characteristics¹

Optical and Electrical Characteristics

Parameter	Symbol	Minimum	Typical	Maximum	Unit
Forward Current ²	I_f		1,050	1,440	mA
Forward Voltage ³	V_f	35.2	37.2	39	V
Power			39	57	W
Operating Junction Temperature ⁴	T_c			105	°C
Light Emitting Surface Diameter	LES		11.0		mm
Thermal Resistance (junction-to-Junction)	Θ_{jc}		-		°C/W
Junction Temperature	T_j			140	°C
Viewing Angle			120		Degree

CHM-14 Operating Characteristics¹

Optical and Electrical Characteristics

Parameter	Symbol	Minimum	Typical	Maximum	Unit
Forward Current ²	I_f		1,750	2,520	mA
Forward Voltage ³	V_f	35.2	37.1	39	V
Power			65	99	W
Operating Junction Temperature ⁴	T_c			105	°C
Light Emitting Surface Diameter	LES		13.5		mm
Thermal Resistance (junction-to-Junction)	Θ_{jc}		0.15		°C/W
Junction Temperature	T_j			140	°C
Viewing Angle			120		Degree

Operating Characteristics Notes

- Note 1: Ratings are based on operation at a constant junction temperature of $T_j = 85^\circ\text{C}$.
- Note 2: To prevent damage refer to operating conditions and derating curves for appropriate maximum operating conditions
- Note 3: Forward voltage range is specified at a typical current drive condition and $T_j = 85^\circ\text{C}$.
- Note 4: CHM COB LEDs are designed for operation up to an absolute maximum forward drive current as specified above. Refer to the current vs. Junction temperature derating curves for further information.
- Note 5: Caution must be taken not to stare at the light emitted from these LEDs. Under special circumstances, the high intensity could damage the eye.
- Note 6: While there is no minimum current rating for any device, it is recommended to not operate device below 20% of typical current values to prevent uneven light emission.

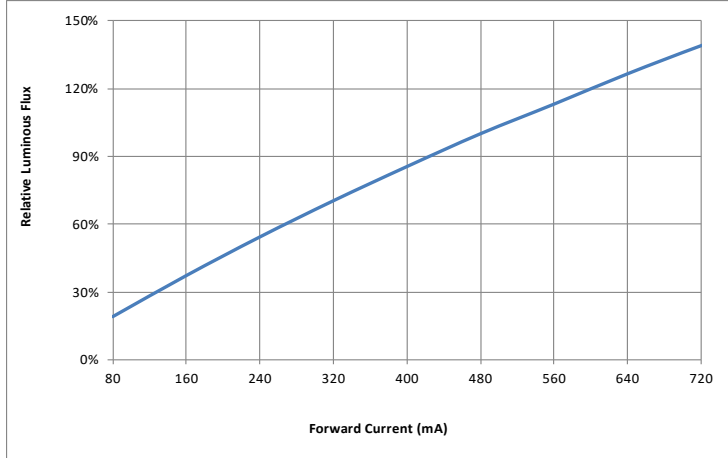
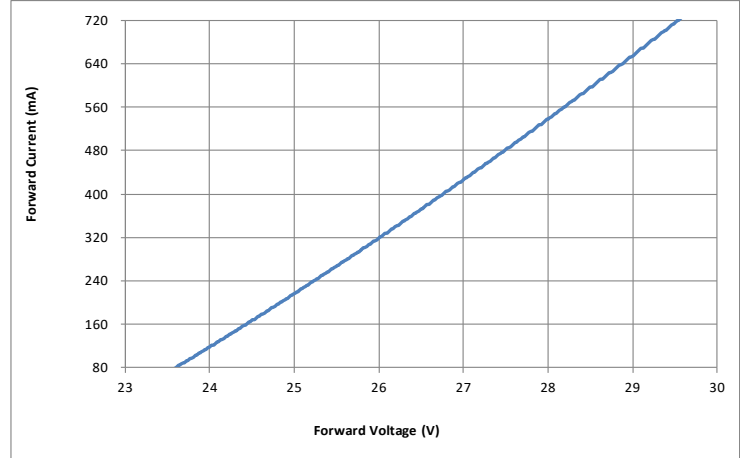
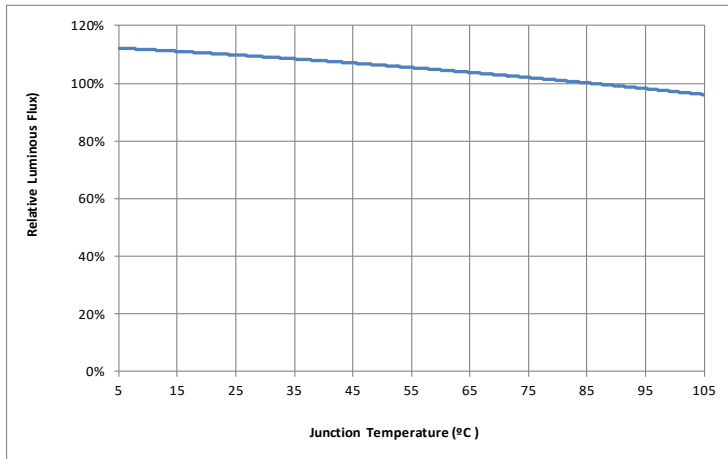
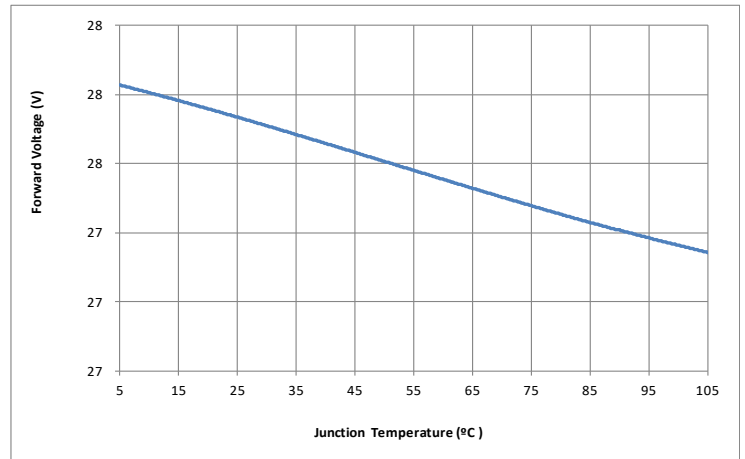
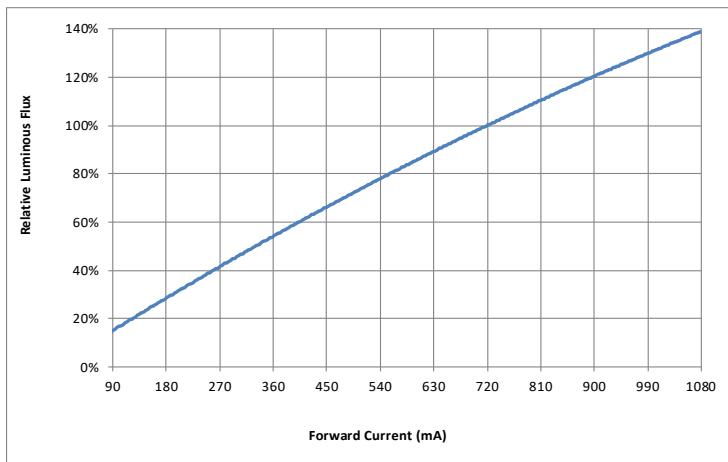
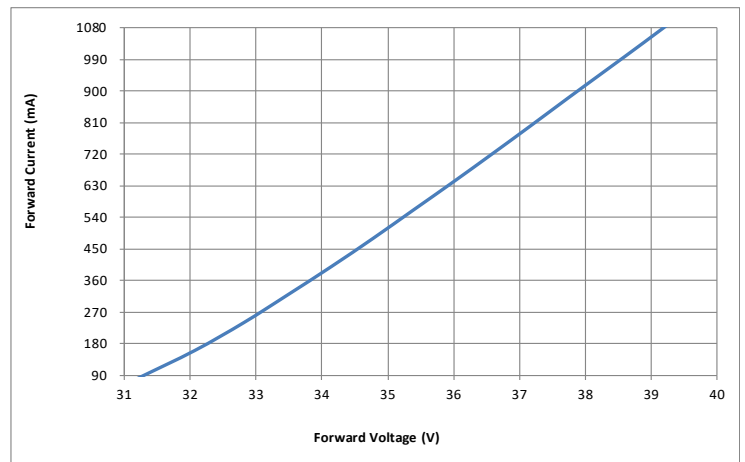
CHM-6 Optical & Electrical Characteristics
Relative Output Flux vs. Forward Current @ 85°C

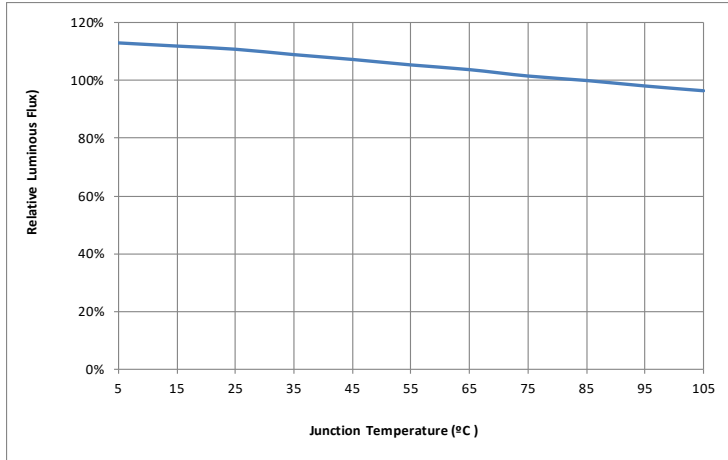
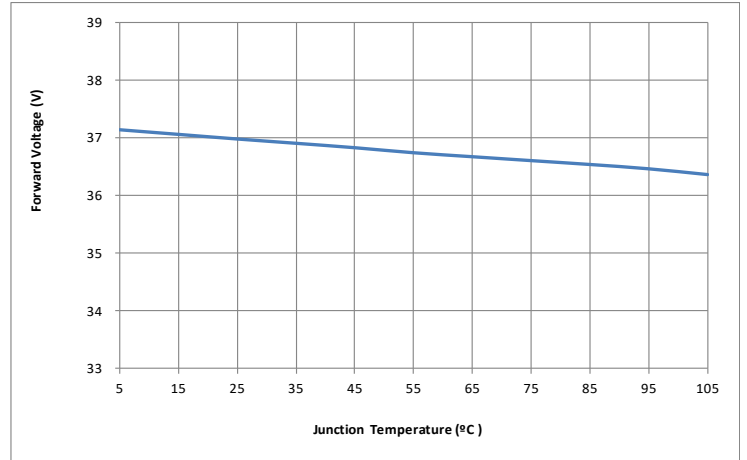
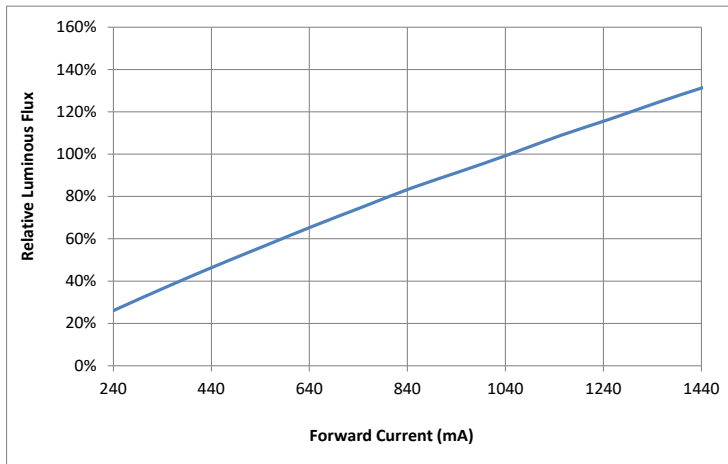
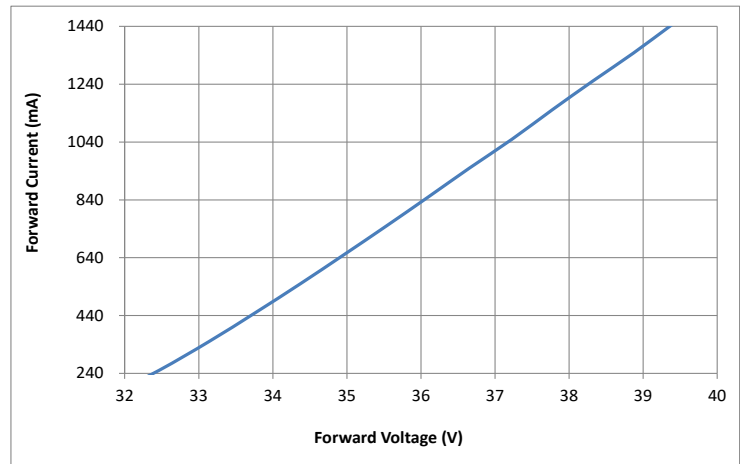
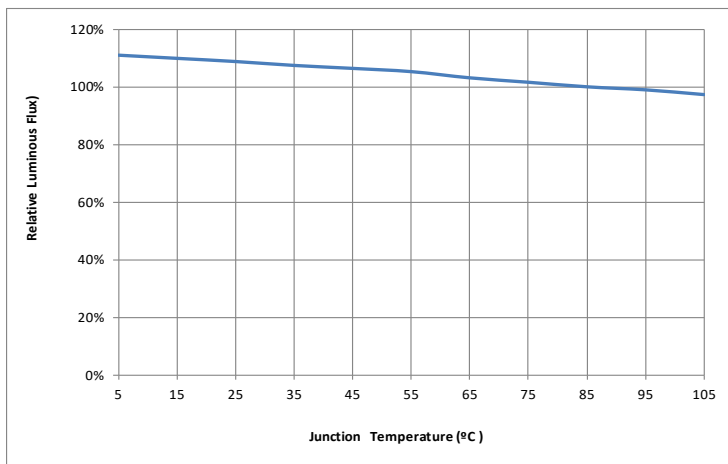
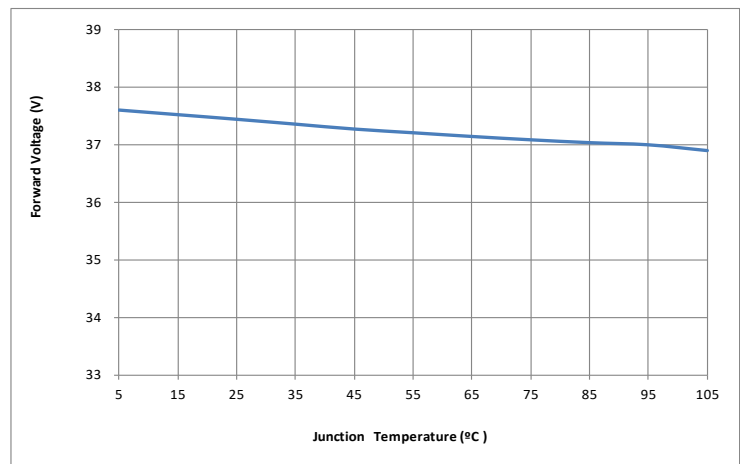
Forward Current vs. Forward Voltage @ 85°C

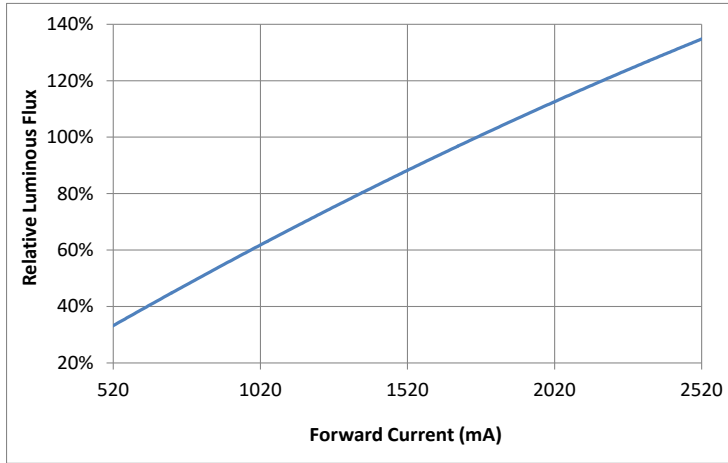
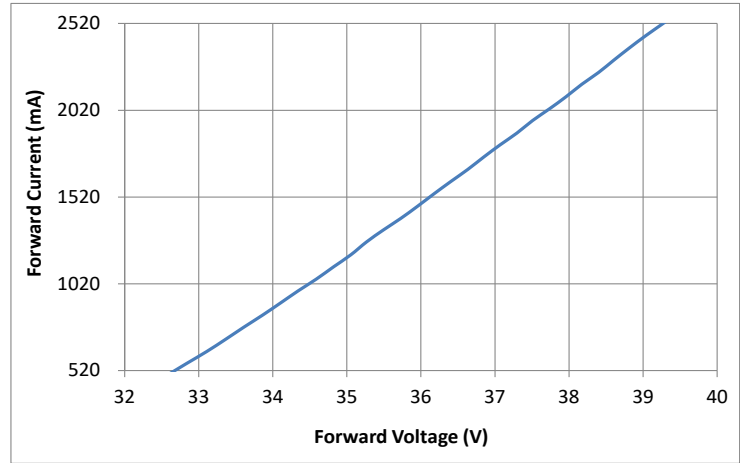
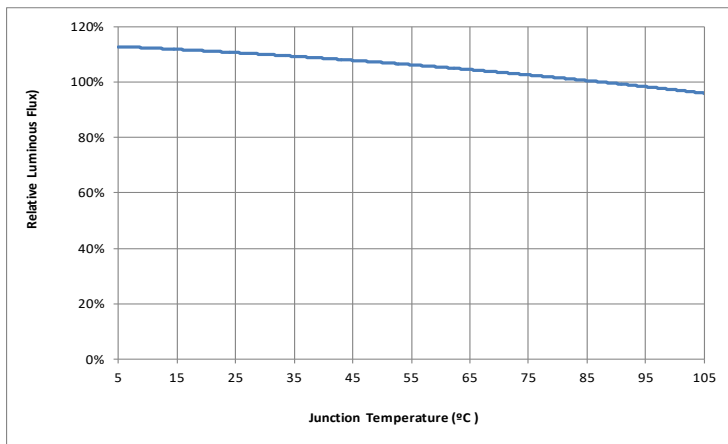
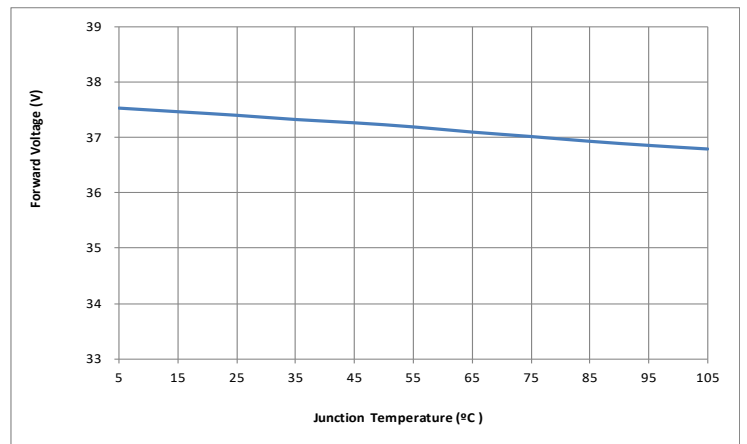
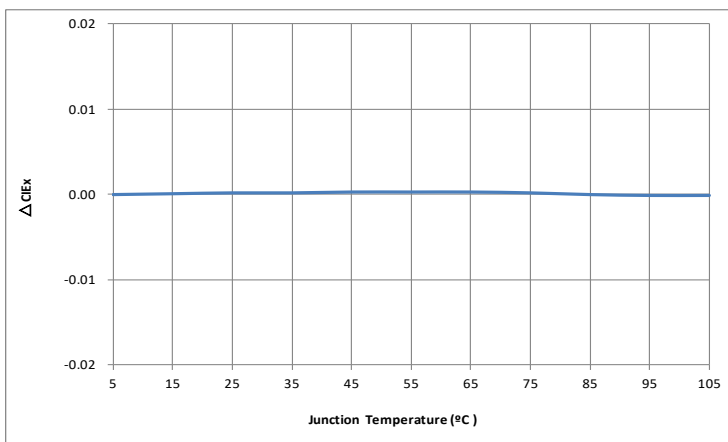
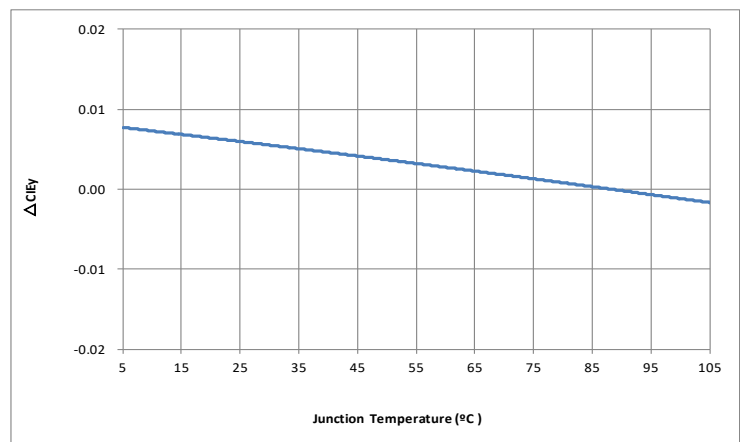
Relative Output Flux vs. Junction Temperature

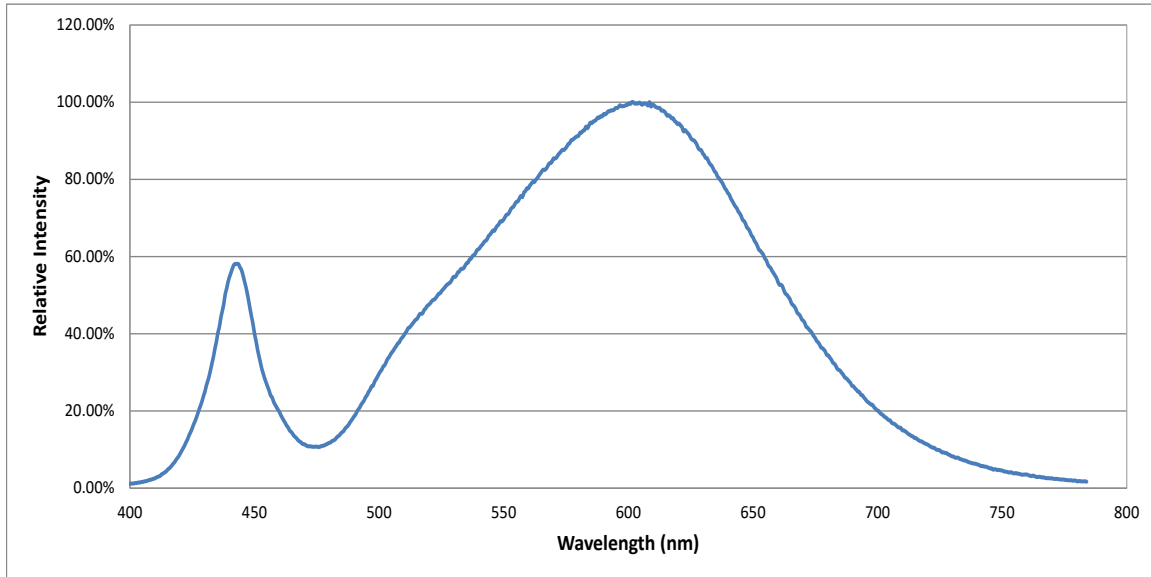
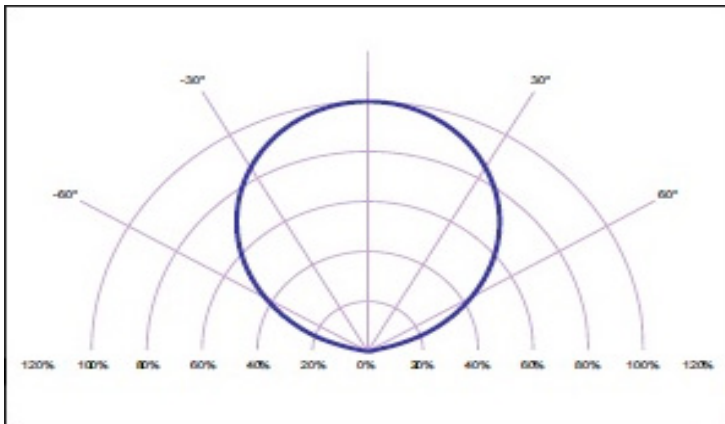
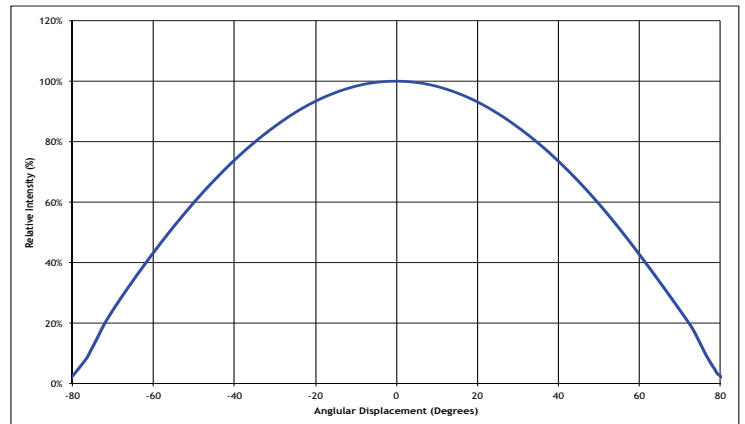
Change in Voltage vs. Junction Temperature

CHM-9 Optical & Electrical Characteristics
Relative Output Flux vs. Forward Current @ 85°C

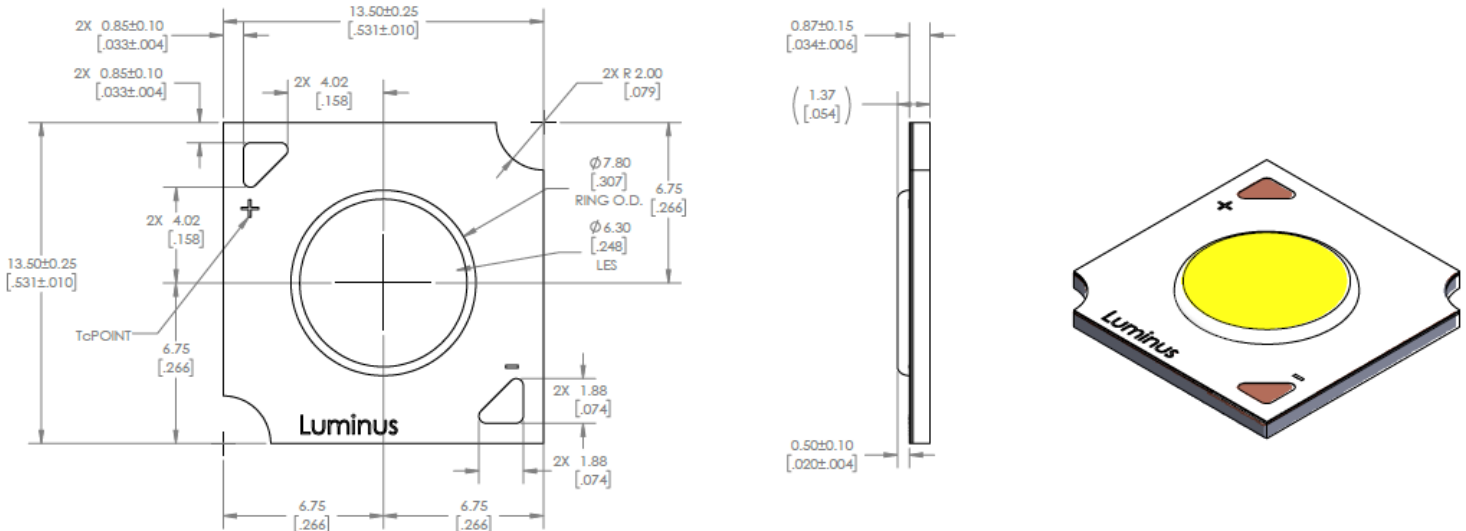
Forward Current vs. Forward Voltage @ 85°C

CHM-9 Optical & Electrical Characteristics
Relative Output Flux vs. Junction Temperature

Change in Voltage vs. Junction Temperature

CHM-11 Optical & Electrical Characteristics
Relative Output Flux vs. Forward Current @ 85°C

Forward Current vs. Forward Voltage @ 85°C

Relative Output Flux vs. Junction Temperature

Change in Voltage vs. Junction Temperature

CHM-14 Optical & Electrical Characteristics
Relative Output Flux vs. Forward Current @ 85°C

Forward Current vs. Forward Voltage @ 85°C

Relative Output Flux vs. Junction Temperature

Change in Voltage vs. Junction Temperature

CHM Chromaticity Shift Characteristics
Change CIE_x vs. Junction Temperature (3000K, 80CRI)

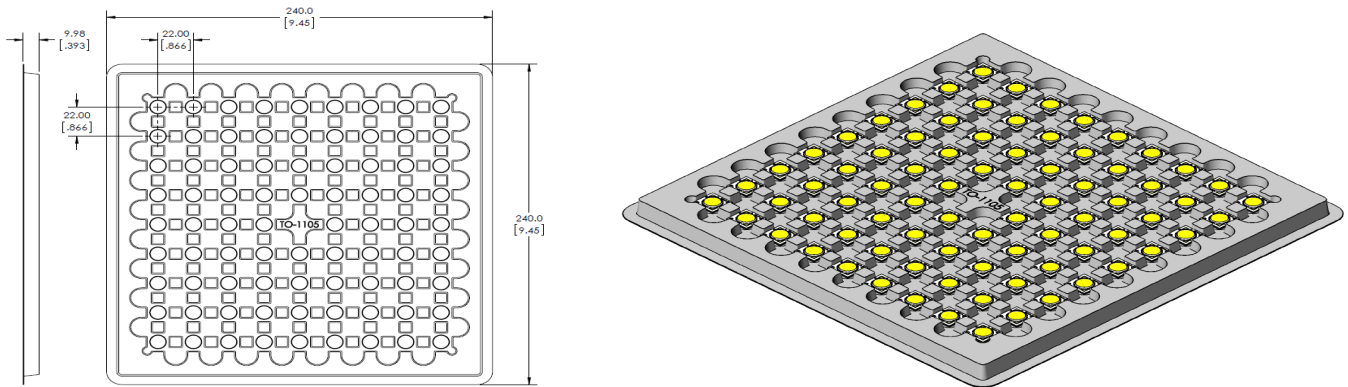
Change CIE_y vs. Junction Temperature (3000K, 80CRI)

Optical Characteristics
Typical Spectrum

Typical Polar Radiation Pattern

Typical Angular Radiation Pattern

Mechanical Dimensions (CHM-6)



Shipping Container (CHM-6)



400 pcs per box
Each bag is boxed for
easier storage/ stacking



Trays are sealed in
an anti-static bag

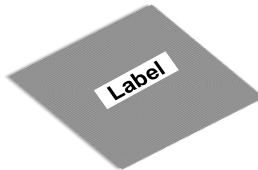

80 pcs per tray
5 trays are stacked together
with separate cover

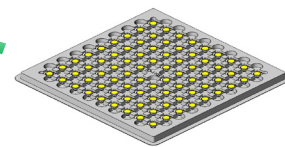

Luminus Label Model:

		Luminus Devices Inc		RoHS Compliant
XXXXXX-XX-XX (Manufacturer Part Number & Bin Kits)		Rev XX		
<input type="text" value="Bar code"/>		<input type="text" value="Bar code"/>		
XXX-XX-XX-XX-XX-XXXX-XX-X (Customer Part Number)		Qty: XX		
<input type="text" value="Bar code"/>		<input type="text" value="Bar code"/>		

Shipping Container (CHM-9/ 11)

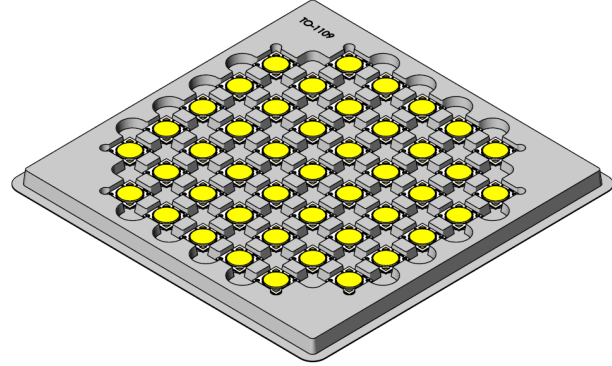
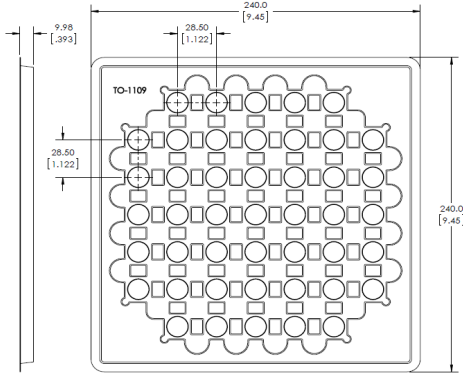

225 pcs per box
Each bag is boxed for
easier storage/ stacking

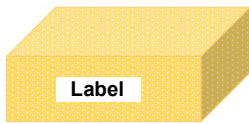

Trays are sealed in
an anti-static bag

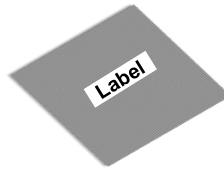

45 pcs per tray
5 trays are stacked together
with separate cover

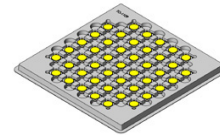

Luminus Label Model:

	Luminus Devices Inc	RoHS Compliant
XXXXXX-XX-XX (Manufacturer Part Number & Bin Kits)	Rev XX	
<input type="text" value="Bar code"/>	<input type="text" value="Bar code"/>	
XXX-XX-XX-XX-XX-XXXX-XX-X (Customer Part Number)		
XXXXXXXXXXXXXXXX (BoxID)	Qty: XX	
<input type="text" value="Bar code"/>	<input type="text" value="Bar code"/>	

Mechanical Dimensions (CHM-14)

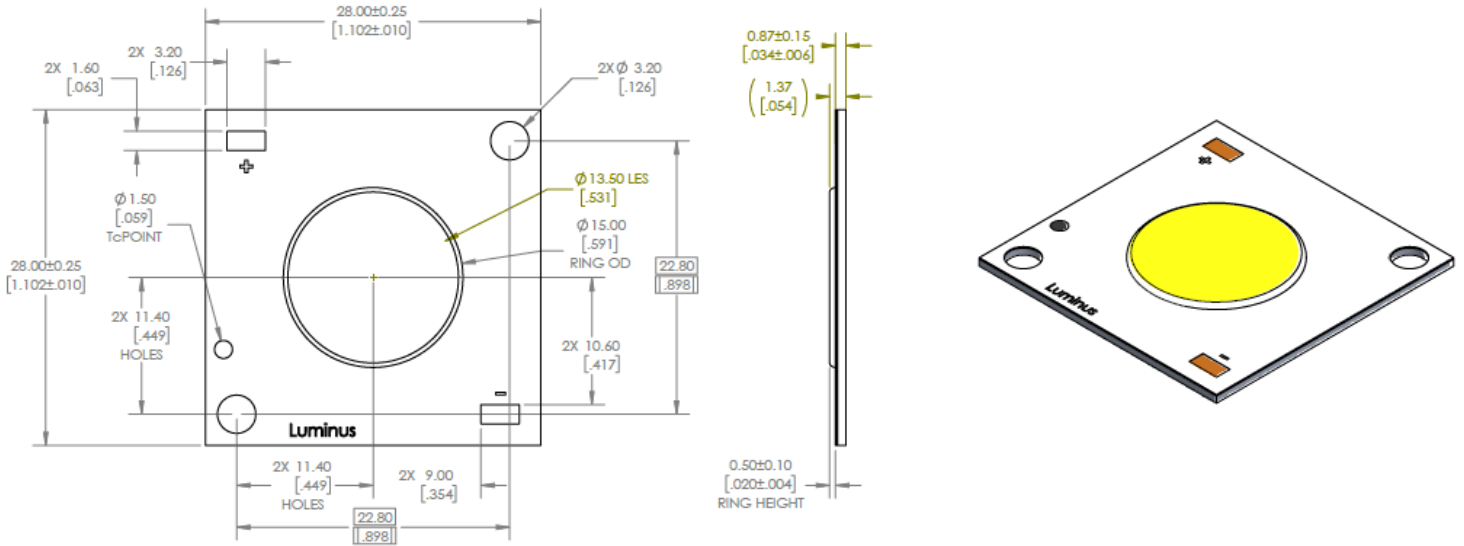

Shipping Container (CHM-14)

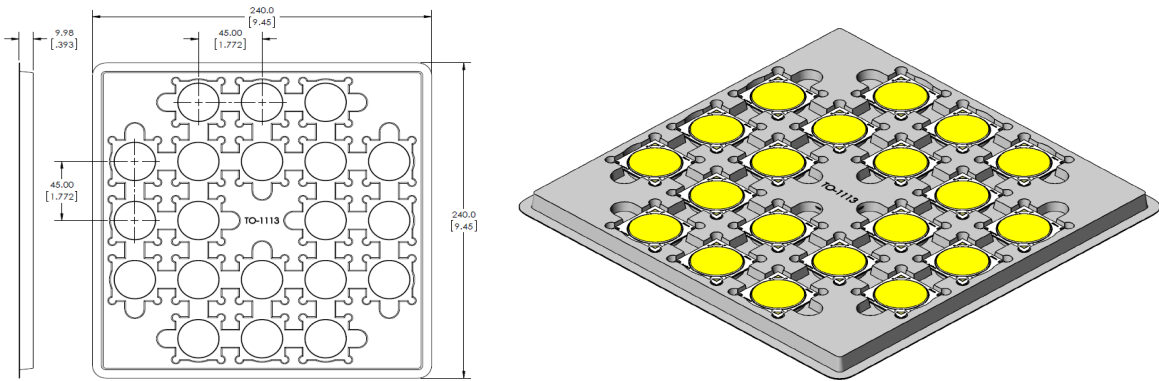

100 pcs per box
Each bag is boxed for easier storage/ stacking

Trays are sealed in an anti-static bag

20 pcs per tray
5 trays are stacked together with separate cover

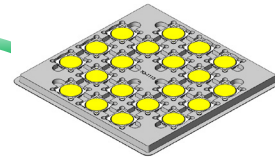
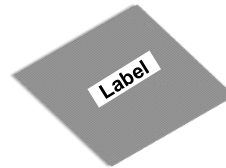

Luminus Label Model:

LUMINUS		Luminus Devices Inc		RoHS Compliant
XXXXXX-XX-XX (Manufacturer Part Number & Bin Kits)	Rev XX	XXXXXX-XX-XX (Manufacturer Part Number & Bin Kits)	Rev XX	
Bar code	Bar code	Bar code	Bar code	
XXX-XX-XX-XX-XX-XXXX-XX-X (Customer Part Number)		XXX-XX-XX-XX-XX-XXXX-XX-X (Customer Part Number)		
XXXXXXXXXXXXXXXX (Box ID)	Qty: XX	XXXXXXXXXXXXXXXX (Box ID)	Qty: XX	
Bar code	Bar code	Bar code	Bar code	

Handling Notes for Luminus COBs

Luminus products are designed for robust performance in general lighting application. However, care must be taken when handling and assembling the LEDs into their fixtures. To avoid damaging Luminus COBs please follow these guide lines.

The following is an overview of the application notes detailing some of the practices to follow when working with these devices. More detailed information is available on the Luminus web site at www.luminus.com.

General Handling

Devices are made to be lifted or carried with tweezers on two adjacent corners opposite the contact pads. At no time should the devices be handled by or should anything come in contact with the light emitting surface (LES) area. This area includes the yellow colored circular area and the ring surrounding it. There are electrical connections under the LES which if damaged will cause the device to fail.

In addition, the ring frame itself should not be used for moving, lifting or carrying the device. Also do not attach any optics or mechanical holders to the ring as it is not capable to handle the mechanical stress.

Static Electricity

Luminus COBs are electronic devices which can be damaged by electrostatic discharge (ESD). Please use appropriate measures to assure the devices do not experience ESD during their handling and or storage. ESD protection guidelines should be used at all times when working with Luminus COBs.

Storage: Luminus products are delivered in ESD shielded bags and should be stored in these bags until used.

Assembly: Individuals handling Luminus COBs during assembly should be trained in ESD protection practices. Assemblers should maintain constant conductive contact with a path to ground by means of a wrist strap, ankle straps, mat or other ESD protection system.

Transporting: When transporting the devices from one assembly area to another, ESD shielded carts and carriers should be used.

Electrical Contact

Luminus COBs are designed with contact pads on their top surface. These pads are clearly marked with + and – polarity. Wires can be soldered to the contact pads for electrical connections or other solderless connector products are available.

If wires are being soldered to the COB product, we recommend attaching these wires prior to mounting the devices to a heat sink. Please contact Luminus for specific recommendations on how to solder wires if not familiar with the standard practice. Luminus can also offer design recommendations for jigs to allow easily soldering multiple products in rapid succession.

Chemical Compatibility

The resin material used to form the LES can get hydrocarbons from the surrounding environment. As a result, certain chemical compounds are not recommended for use with the Luminus products. Use of these compounds can cause damage to the light output of the device and may permanently damage the device. Please refer to www.luminus.com for a list of the compounds not recommended for use with the Luminus COB products.

Thermal Interface Material (TIM)

Proper thermal management is critical for successful operation of any LED system. Excess operating temperature can reduce the light output of the device. And excessive heating can cause permanent damage to the device. Proper TIM material is a crucial component for effective heat transfer away from the LED during normal operation. Please refer to www.luminus.com for specific recommendations for TIM solutions.