

P-Channel Power MOSFET

-20V, -11A, 16mΩ

FEATURES

- Fast Switching
- Suitable for 1.8V drive applications
- RoHS compliant
- Halogen-free according to IEC 61249-2-21

APPLICATIONS

- Load Switch
- Networking

PRODUCT SUMMARY			
PARAMETER	VALUE	UNIT	
V_{DS}	-20	V	
$R_{DS(on)}$ (max)	$V_{GS} = -4.5V$	16	mΩ
	$V_{GS} = -2.5V$	22	
	$V_{GS} = -1.8V$	28	
Q_g	$V_{GS} = 4.5V$	24	nC

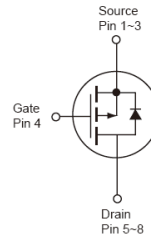

Notes: MSL 3 (Moisture Sensitivity Level) per J-STD-020

ABSOLUTE MAXIMUM RATINGS ($T_A = 25^\circ C$ unless otherwise noted)				
PARAMETER	SYMBOL	LIMIT	UNIT	
Drain-Source Voltage	V_{DS}	-20	V	
Gate-Source Voltage	V_{GS}	± 10	V	
Continuous Drain Current, Silicon limited	$T_C = 25^\circ C$	I_D	-14	A
Continuous Drain Current (Note 1)	$T_C = 25^\circ C$	I_D	-11	A
	$T_C = 100^\circ C$		-7	
Pulsed Drain Current (Note 2)		I_{DM}	-44	A
Total Power Dissipation	$T_C = 25^\circ C$	P_D	5	W
Operating Junction and Storage Temperature Range		T_J, T_{STG}	- 55 to +150	$^\circ C$

THERMAL RESISTANCE			
PARAMETER	SYMBOL	MAXIMUM	UNIT
Thermal Resistance – Junction to Case	$R_{\theta JC}$	25	$^\circ C/W$
Thermal Resistance – Junction to Ambient	$R_{\theta JA}$	50	$^\circ C/W$

Notes: $R_{\theta JA}$ is the sum of the junction-to-case and case-to-ambient thermal resistances. The case thermal reference is defined at the solder mounting surface of the drain pins. $R_{\theta JA}$ is guaranteed by design while $R_{\theta CA}$ is determined by the user's board design. $R_{\theta JA}$ shown below for single device operation on FR-4 PCB in still air.

ELECTRICAL CHARACTERISTICS ($T_A = 25^\circ\text{C}$ unless otherwise noted)						
PARAMETER	CONDITIONS	SYMBOL	MIN	TYP	MAX	UNIT
Static						
Drain-Source Breakdown Voltage	$V_{GS} = 0\text{V}, I_D = -250\mu\text{A}$	BV_{DSS}	-20	--	--	V
Gate Threshold Voltage	$V_{GS} = V_{DS}, I_D = -250\mu\text{A}$	$V_{GS(TH)}$	-0.3	-0.5	-1.0	V
Gate-Source Leakage Current	$V_{GS} = \pm 10\text{V}, V_{DS} = 0\text{V}$	I_{GSS}	--	--	± 100	nA
Drain-Source Leakage Current	$V_{GS} = 0\text{V}, V_{DS} = -20\text{V}$	I_{DSS}	--	--	-1	μA
Drain-Source On-State Resistance (Note 3)	$V_{GS} = -4.5\text{V}, I_D = -6\text{A}$	$R_{DS(on)}$	--	13	16	m Ω
	$V_{GS} = -2.5\text{V}, I_D = -4\text{A}$		--	16	22	
	$V_{GS} = -1.8\text{V}, I_D = -3\text{A}$		--	22	28	
Dynamic (Note 4)						
Total Gate Charge	$V_{DS} = -10\text{V}, I_D = -6\text{A},$ $V_{GS} = -4.5\text{V}$	Q_g	--	24	--	nC
Gate-Source Charge		Q_{gs}	--	3.4	--	
Gate-Drain Charge		Q_{gd}	--	4	--	
Input Capacitance	$V_{GS} = 0\text{V}, V_{DS} = -15\text{V},$ $f = 1.0\text{MHz}$	C_{iss}	--	2565	--	pF
Output Capacitance		C_{oss}	--	232	--	
Reverse Transfer Capacitance		C_{rss}	--	120	--	
Switching (Note 5)						
Turn-On Delay Time	$V_{GS} = -4.5\text{V},$ $V_{DD} = -10\text{V},$ $I_D = -1\text{A}, R_{GEN} = 25\Omega$	$t_{d(on)}$	--	12	--	ns
Rise Time		t_r	--	18	--	
Turn-Off Delay Time		$t_{d(off)}$	--	153	--	
Fall Time		t_f	--	60	--	
Source-Drain Diode						
Diode Forward Voltage (Note 3)	$V_{GS} = 0\text{V}, I_S = -1\text{A}$	V_{SD}	--	--	-1	V

Notes:

1. Package current limit.
2. Pulsed width limited by maximum junction temperature.
3. Pulse test: Pulse $\leq 300\mu\text{s}$, duty cycle $\leq 2\%$.
4. For DESIGN AID ONLY, not subject to production testing.
5. Switching time is essentially independent of operating temperature.

ORDERING INFORMATION

ORDERING CODE	PACKAGE	PACKING
TSM160P02CS RLG	SOP-8	2.5Kpcs / 13"Reel

CHARACTERISTICS CURVES

($T_A = 25^\circ\text{C}$ unless otherwise noted)

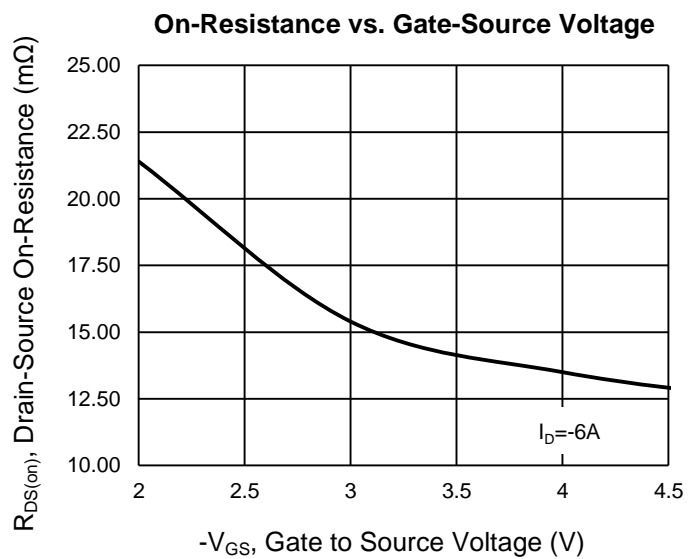
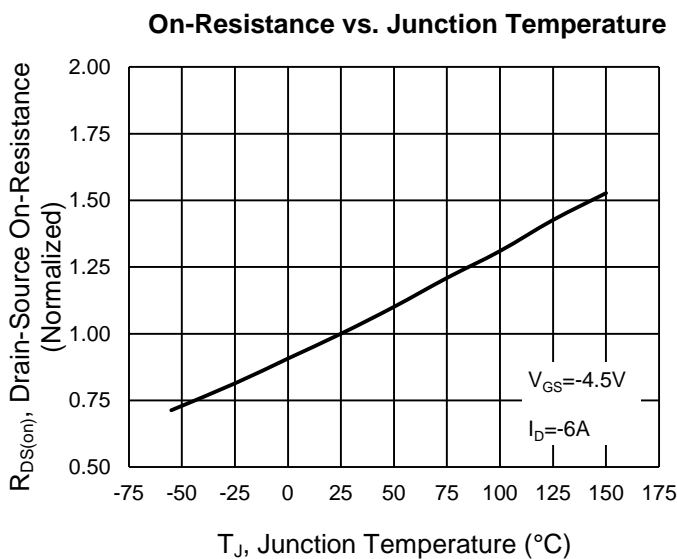
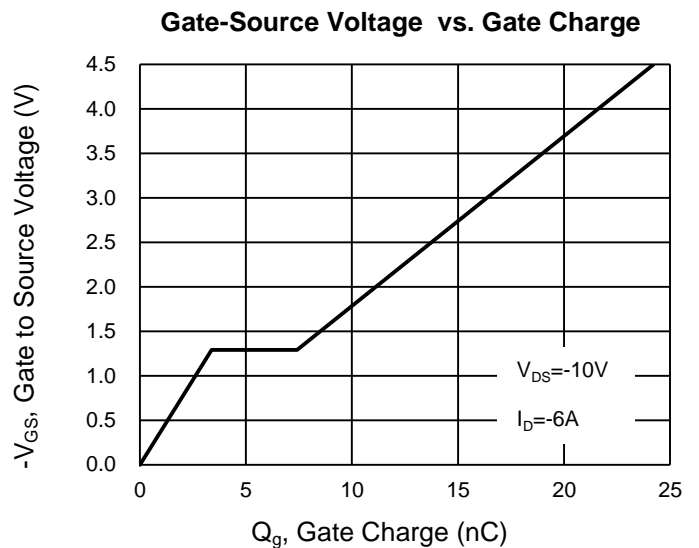
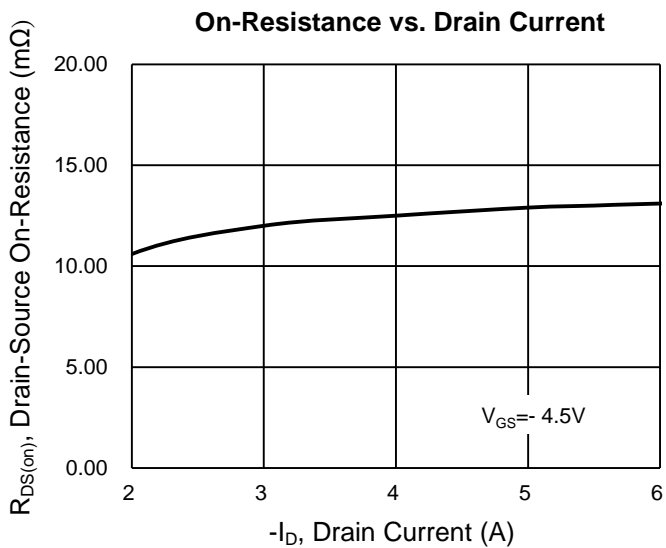
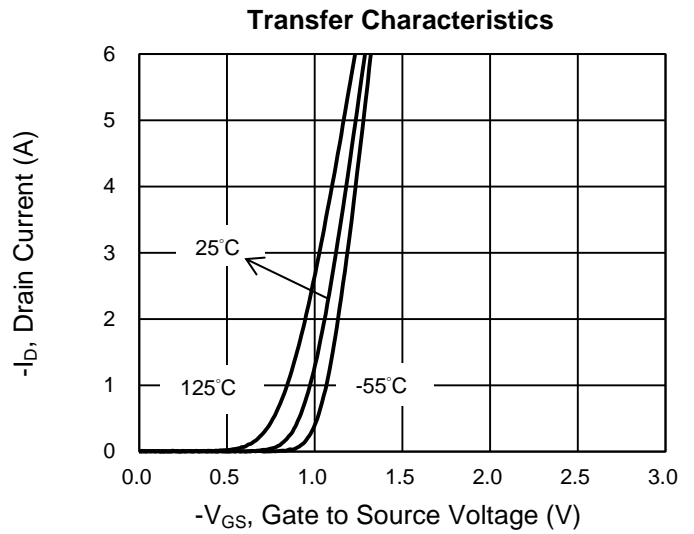
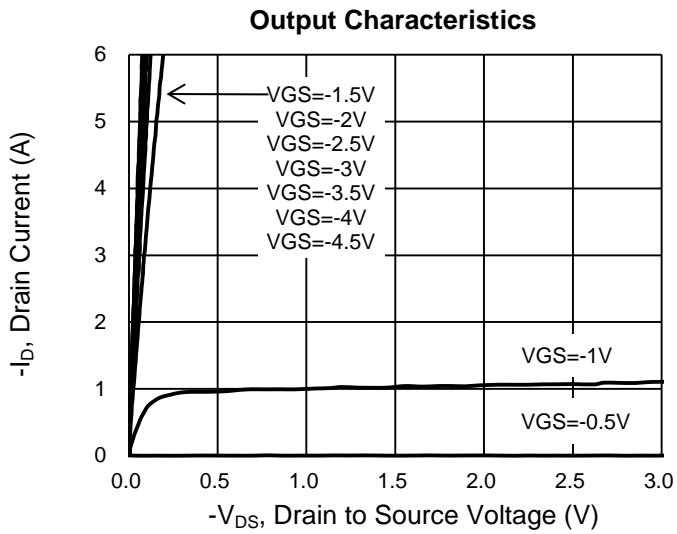

CHARACTERISTICS CURVES

($T_A = 25^\circ\text{C}$ unless otherwise noted)

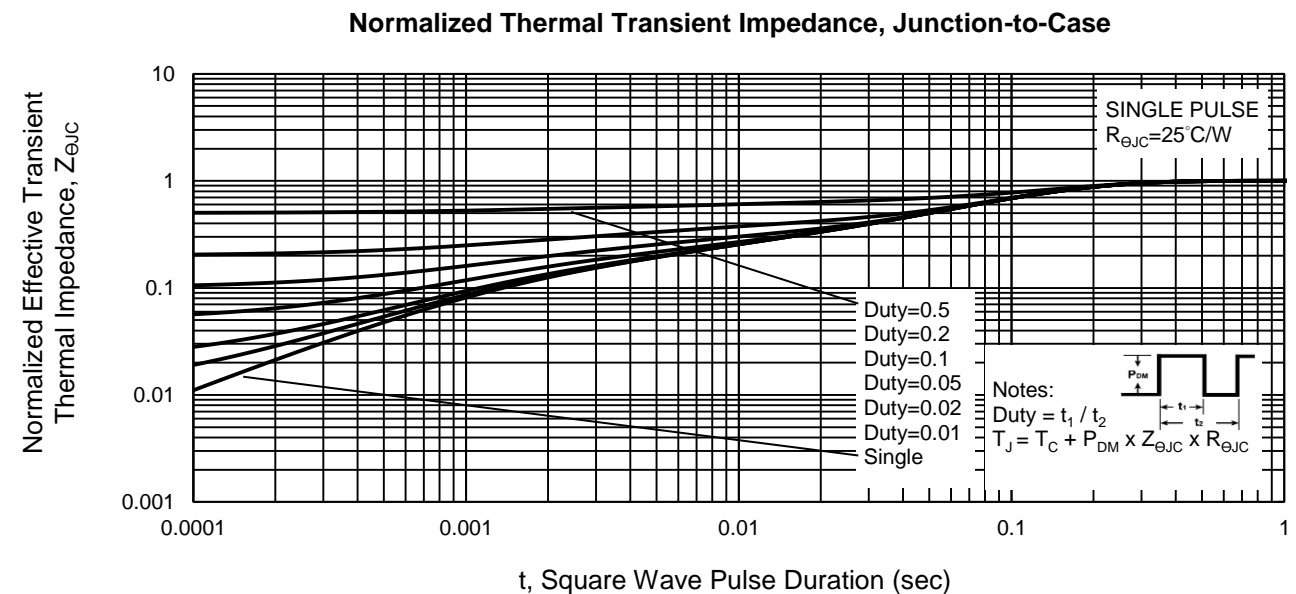
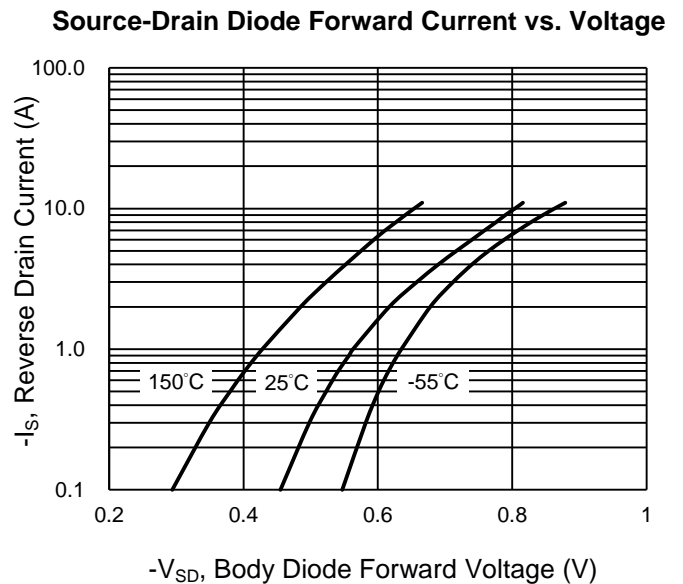
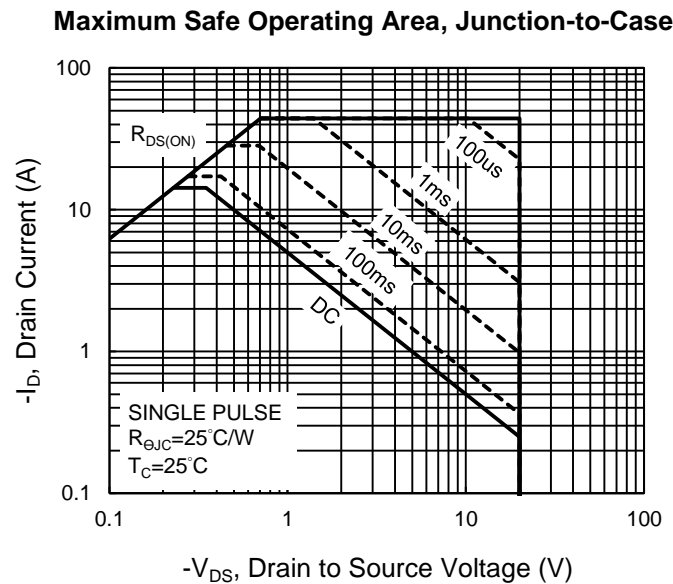
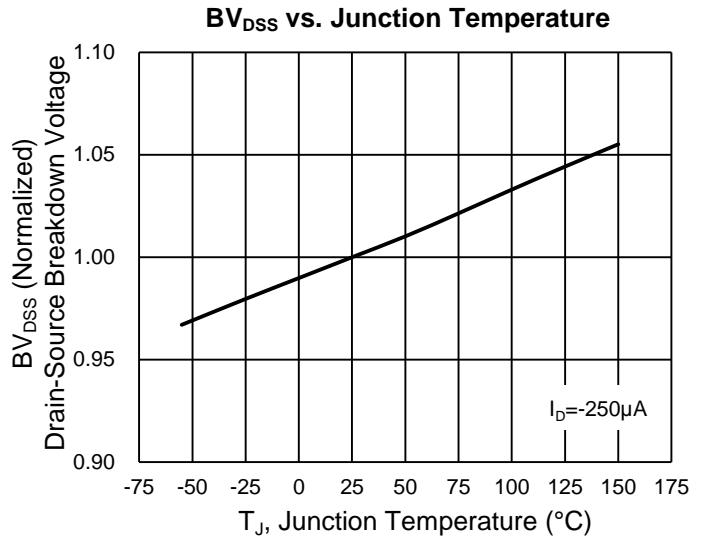
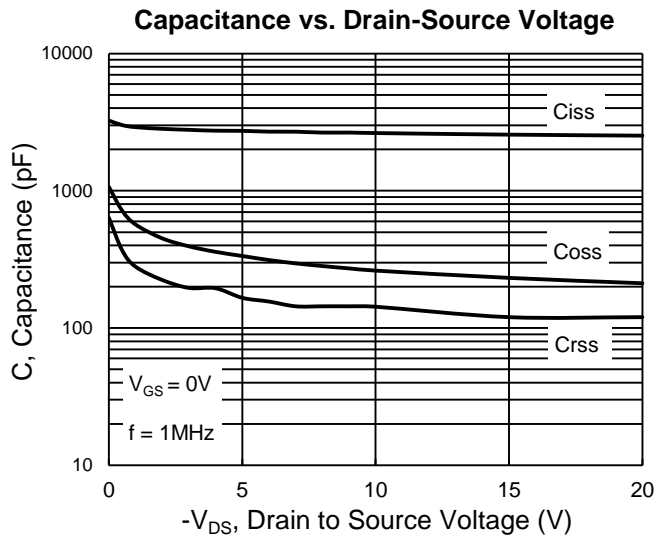

CHARACTERISTICS CURVES

($T_A = 25^\circ\text{C}$ unless otherwise noted)

Power Dissipation

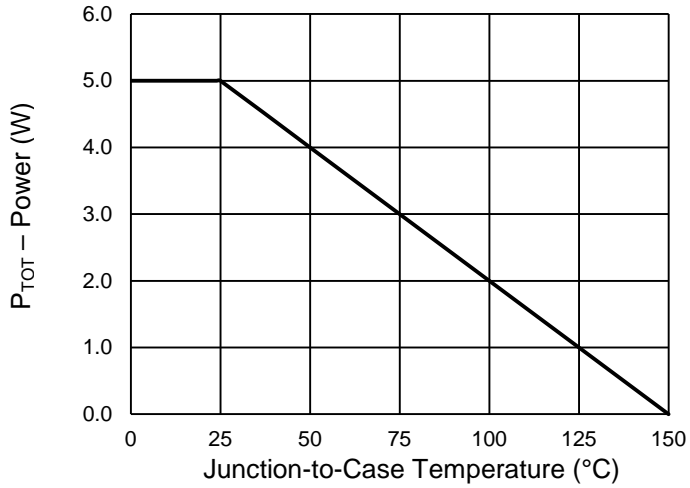

Drain Current

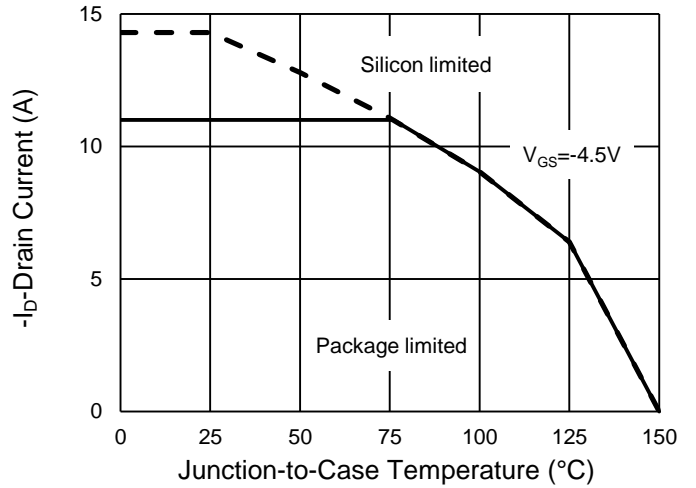

Normalized gate threshold voltage vs Temperature

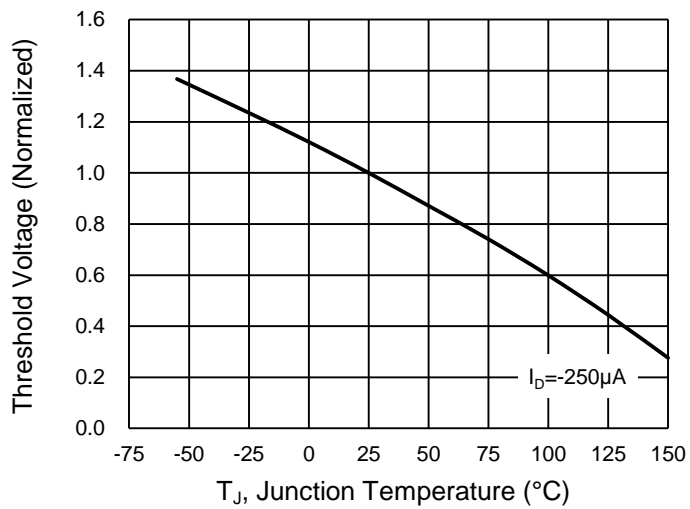

PACKAGE OUTLINE DIMENSIONS (Unit: Millimeters)

SOP-8

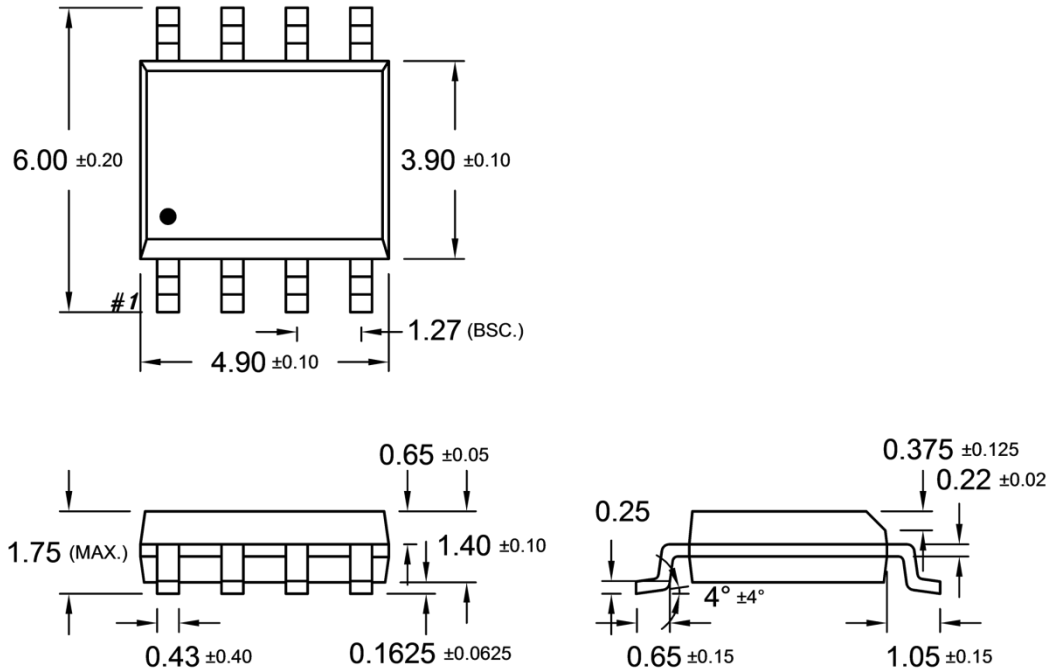

SUGGESTED PAD LAYOUT (Unit: Millimeters)

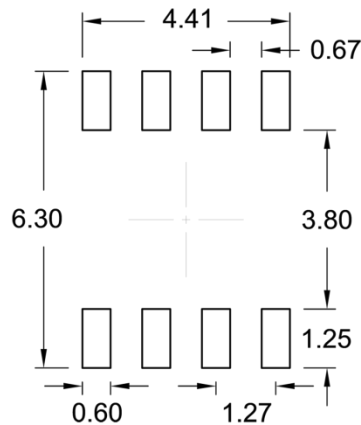

MARKING DIAGRAM

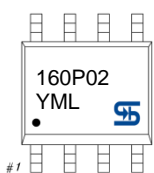

Y = Year Code

M = Month Code

O =Jan **P** =Feb **Q** =Mar **R** =Apr

S =May **T** =Jun **U** =Jul **V** =Aug

W =Sep **X** =Oct **Y** =Nov **Z** =Dec

L = Lot Code (1~9, A~Z)

Notice

Specifications of the products displayed herein are subject to change without notice. TSC or anyone on its behalf, assumes no responsibility or liability for any errors or inaccuracies.

Purchasers are solely responsible for the choice, selection, and use of TSC products and TSC assumes no liability for application assistance or the design of Purchasers' products.

Information contained herein is intended to provide a product description only. No license, express or implied, to any intellectual property rights is granted by this document. Except as provided in TSC's terms and conditions of sale for such products, TSC assumes no liability whatsoever, and disclaims any express or implied warranty, relating to sale and/or use of TSC products including liability or warranties relating to fitness for a particular purpose, merchantability, or infringement of any patent, copyright, or other intellectual property right.

The products shown herein are not designed for use in medical, life-saving, or life-sustaining applications. Customers using or selling these products for use in such applications do so at their own risk and agree to fully indemnify TSC for any damages resulting from such improper use or sale.