

Dual-band Reach Xtend™ (FR05-S1-NO-1-003) – 2.4-2.5 GHz and 4.9-5.875 GHz

Fractus Antennas specializes in enabling effective mobile communications. Using Fractus technology, we design and manufacture optimized antennas to make your wireless devices more competitive. Our mission is to help our clients develop innovative products and accelerate their time to market through our expertise in antenna design, testing and manufacturing.



Dual-band Reach Xtend™

FR05-S1-NO-1-003

Fractus Antennas products are protected by [Fractus patents](#).

All information contained within this document is property of Fractus Antennas and is subject to change without prior notice. Information is provided “as is” and without warranties. It is prohibited to copy or reproduce this information without prior approval.

Fractus Antennas is an ISO 9001:2015 certified company. All our antennas are lead-free and RoHS compliant.

ISO 9001: 2015 Certified



INDEX OF CHAPTERS

1.	ANTENNA DESCRIPTION	4
2.	QUICK REFERENCE GUIDE	4
3.	ELECTRICAL PERFORMANCE	5
4.	MECHANICAL CHARACTERISTICS.....	9
5.	MATCHING NETWORK	10
6.	ASSEMBLY PROCESS	11
7.	PACKAGING	13

TABLE OF CONTENTS

1. ANTENNA DESCRIPTION	4
2. QUICK REFERENCE GUIDE	4
3. ELECTRICAL PERFORMANCE	5
3.1. FRACTUS EVALUATION BOARD	5
3.2. VSWR AND EFFICIENCY	5
3.3. RADIATION PATTERNS, GAIN AND EFFICIENCY	6
3.4. CAPABILITIES AND MEASUREMENT SYSTEMS	8
4. MECHANICAL CHARACTERISTICS.....	9
4.1. DIMENSIONS AND TOLERANCES	9
4.2. SPECIFICATIONS FOR THE INK.....	9
4.3. ANTENNA FOOTPRINT and FRACPLANE® DIMENSIONS	10
5. MATCHING NETWORK	10
6. ASSEMBLY PROCESS	11
7. PACKAGING	13

1. ANTENNA DESCRIPTION

The Dual-band Reach Xtend™ 802.11 a/b/g/n WLAN Chip Antenna is engineered to operate at both 2.4 GHz and 5 GHz bands.

Dual-band Reach Xtend™ lets you achieve high performance at a low cost. Taking advantage of both spatial and polarization diversity, it will increase the reliability of your device's data rate. This, combined with high isolation, makes it ideal for use within indoor (highly scattered) environments while navigating through inconsistent hotspot infrastructures.

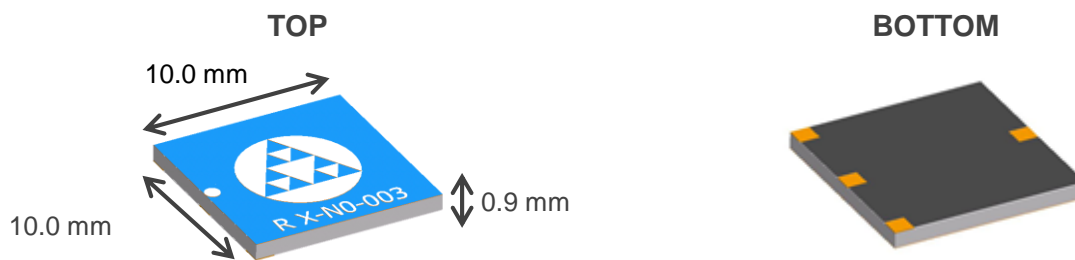

Material: The Dual-band Reach Xtend™ antenna is built on glass epoxy substrate.

APPLICATIONS

- PLC (Power Line Communications)
- Modules (Cardbus 32)
- TV (CATV)
- Smart Train
- Digital Media Adapter

BENEFITS

- High efficiency and gain
- Cost-effective
- Multiband behaviour. Worldwide standard compatible
- Easy to use (pick and place)

2. QUICK REFERENCE GUIDE

Technical Features	802.11 b/g/n	802.11 a/n
Frequency Range	2.4 – 2.5 GHz	4.9 – 5.875 GHz
Average Efficiency	75.0 %	74.6 %
Peak Gain	3.9 dBi	6.0 dBi
VSWR	< 2:1	< 2:1
Isolation	> 12 dB	> 16 dB
Radiation Pattern	Omnidirectional	
Weight (approx.)	0.2 g	
Temperature	-40 to 85° C	
Impedance	50 Ω	
Dimensions (L x W x H)	10.0 mm x 10.0 mm x 0.9 mm	

Table 1 – Technical Features. Measures from the evaluation board. See Figure 1 and picture in Table 2.

Please contact info@fractusantennas.com if you require additional information on antenna integration or optimization on your PCB.

3. ELECTRICAL PERFORMANCE

The antenna and ground plane configuration described in this section takes advantage of the FracPlane® technology. This Fractus patented design technologies allow to improve the performance of the antennas by optimizing of the PCB ground plane.

3.1. FRACTUS EVALUATION BOARD

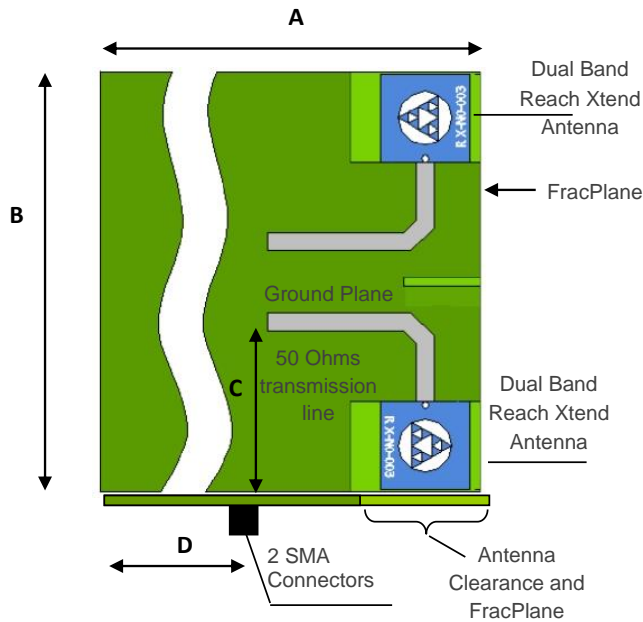

Measure	mm
A	105.0
B	47.5
C	18.0
D	82.0

Tolerance: ±0.2mm

Material: The evaluation board is built on FR4 substrate. Thickness is 1.0mm.

Figure 1 – EB_FR05-S1-NO-1-003. Dual-band Reach Xtend™ Evaluation Board.

3.2. VSWR AND EFFICIENCY

VSWR (Voltage Standing Wave Ratio) and Total Efficiency versus Frequency (GHz).

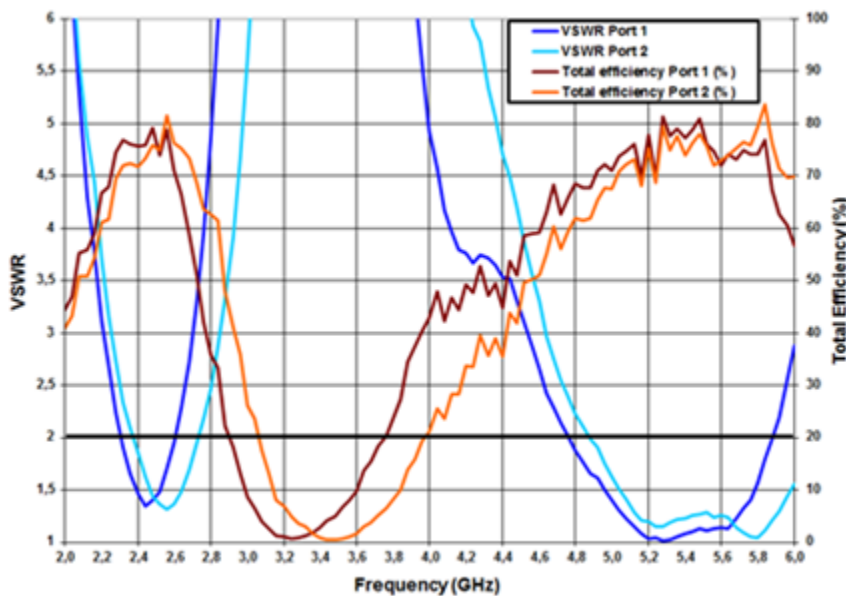

Port 1: Left antenna
Port 2: Right antenna

Figure 2 – VSWR and Efficiency (%) vs. Frequency (GHz).

3.3. RADIATION PATTERNS, GAIN AND EFFICIENCY

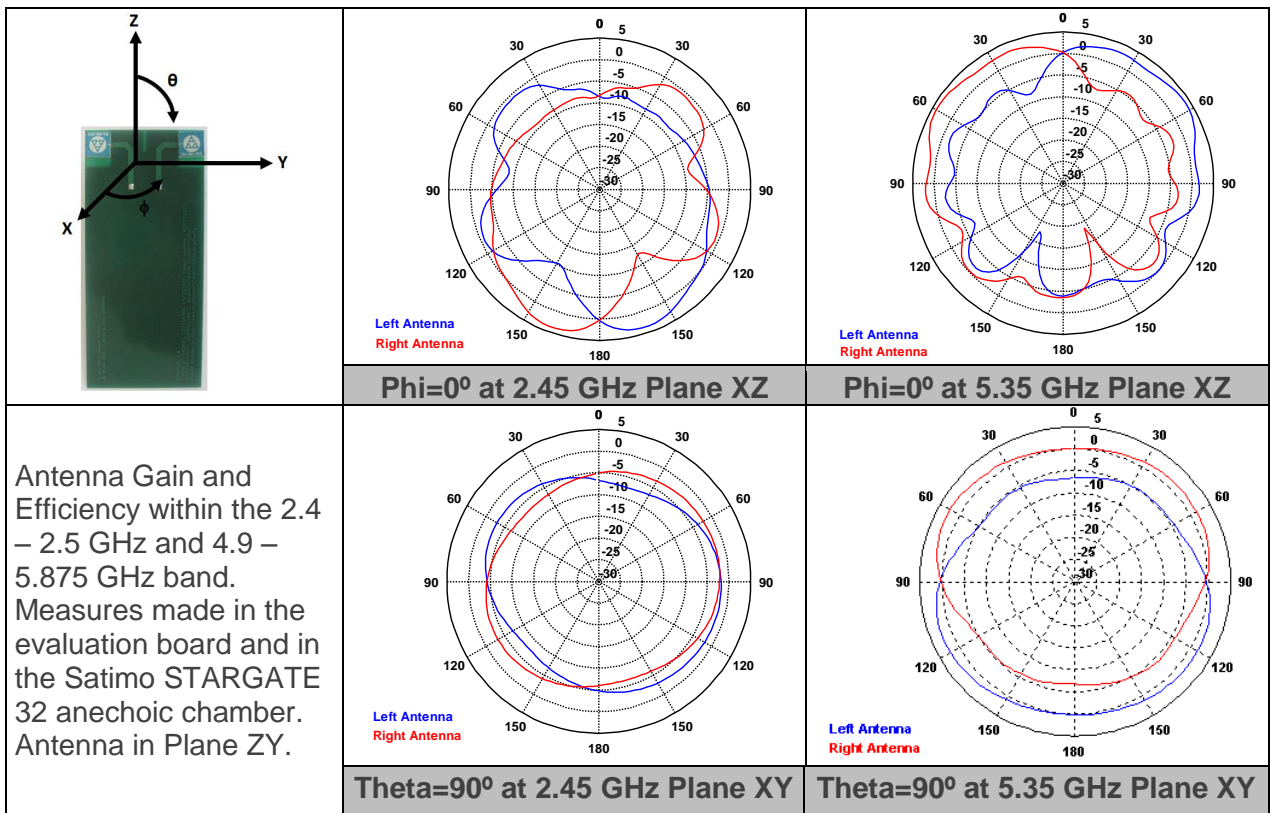

Antenna Gain and Efficiency within the 2.4 – 2.5 GHz and 4.9 – 5.875 GHz band. Measures made in the evaluation board and in the Satimo STARGATE 32 anechoic chamber. Antenna in Plane ZY.

Left Antenna		2.4 – 2.5 GHz	4.9 – 5.875 GHz
Gain	Peak Gain	3.9 dBi	5.3 dBi
	Average Gain across the band	3.7 dBi	4.6 dBi
	Gain Range across the band (min, max)	3.5 <-> 3.9 dBi	3.8 <-> 5.3 dBi
Efficiency	Peak Efficiency	79.2 %	81.3 %
	Average Efficiency across the band	76.2 %	74.7 %
	Efficiency Range across the band (min, max)	73.9 – 79.2 %	67.3 – 81.3 %

Right Antenna		2.4 – 2.5 GHz	4.9 – 5.875 GHz
Gain	Peak Gain	3.6 dBi	6.0 dBi
	Average Gain across the band	3.4 dBi	4.5 dBi
	Gain Range across the band (min, max)	3.0 <--> 3.6 dBi	2.6 <--> 6.0 dBi
Efficiency	Peak Efficiency	76.0 %	83.6 %
	Average Efficiency across the band	73.8 %	74.5 %
	Efficiency Range across the band (min, max)	71.7 – 76.0 %	65.4 – 83.6 %

Table 2 – Antenna Gain and Efficiency within the 2.4 – 2.5 GHz band and the 4.9 – 5.875 GHz band for both the left-located and the right-located antennas. Measures made in the evaluation board and in the Satimo STARGATE 32 anechoic chamber.

3.4. CAPABILITIES AND MEASUREMENT SYSTEMS

Fractus Antennas specializes in the design and manufacture of optimized antennas for wireless applications, and with the provision of RF expertise to a wide range of clients. We offer turn-key antenna products and antenna integration support to minimize your time requirements and maximize return on investment throughout the product development process. We also provide our clients with the opportunity to leverage our in-house testing and measurement facilities to obtain accurate results quickly and efficiently.

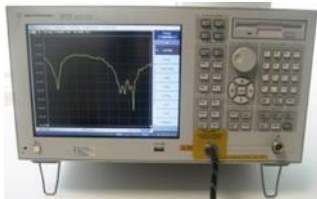

Agilent E5071B

VSWR
&
S Parameters

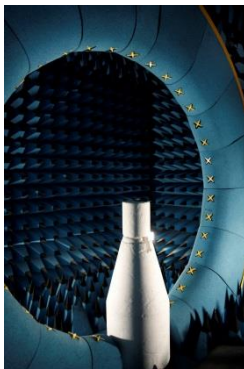
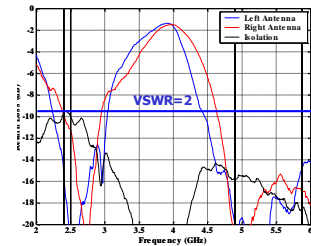

SATIMO STARGATE 32

Radiation
Pattern
&
Efficiency

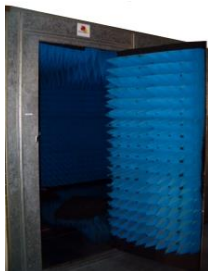
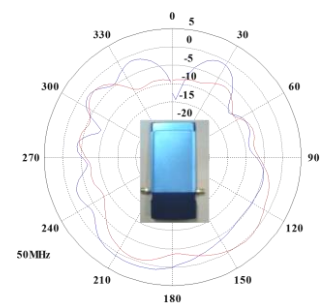

Anechoic chambers and full equipped in-house lab

4. MECHANICAL CHARACTERISTICS

4.1. DIMENSIONS AND TOLERANCES

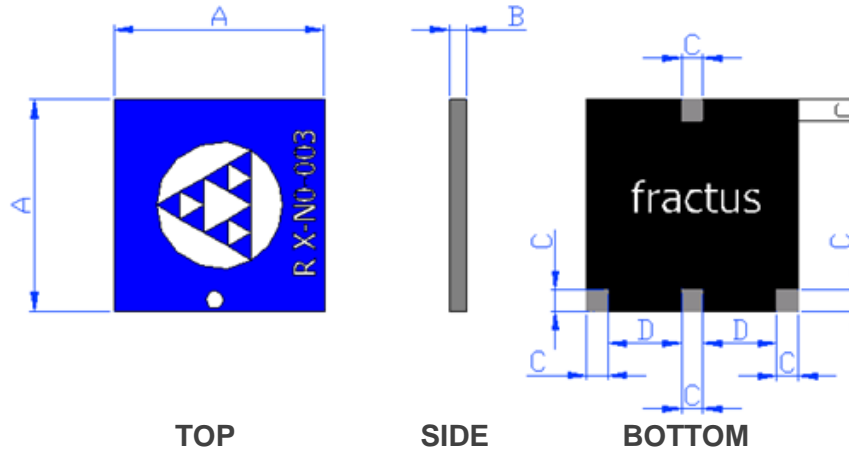

The white dot located on the top side of the antenna indicates the feed pad.

Measure	mm	Measure	mm
A	10.0 ± 0.2	C	1.0 ± 0.1
B	0.9 ± 0.2	D	3.5 ± 0.2

Figure 3 – Antenna Dimensions and Tolerances.

Fractus Dual-band Reach Xtend™ chip antenna is compliant with the restriction of the use of hazardous substances (**RoHS**).

The RoHS certificate can be downloaded from www.fractusantennas.com.

4.2. SPECIFICATIONS FOR THE INK

Next figure shows the correct colors of the antenna:

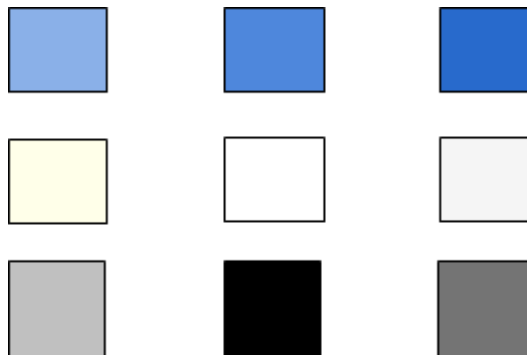

Acceptable color range

4.3. ANTENNA FOOTPRINT and FRACPLANE® DIMENSIONS

This antenna footprint applies for the reference evaluation board described on page 5 of this User Manual. Feeding line dimensions over the clearance zone described in Figure 4 apply for a 0.8 mm thickness FR4 PCB.

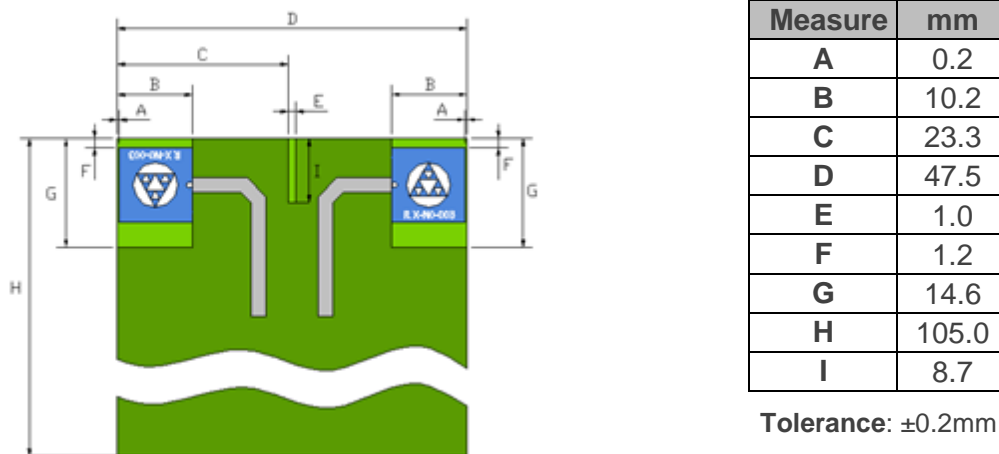

Figure 4 – Dimensions of the clearance areas and the FracPlane® (slot on the PCB).

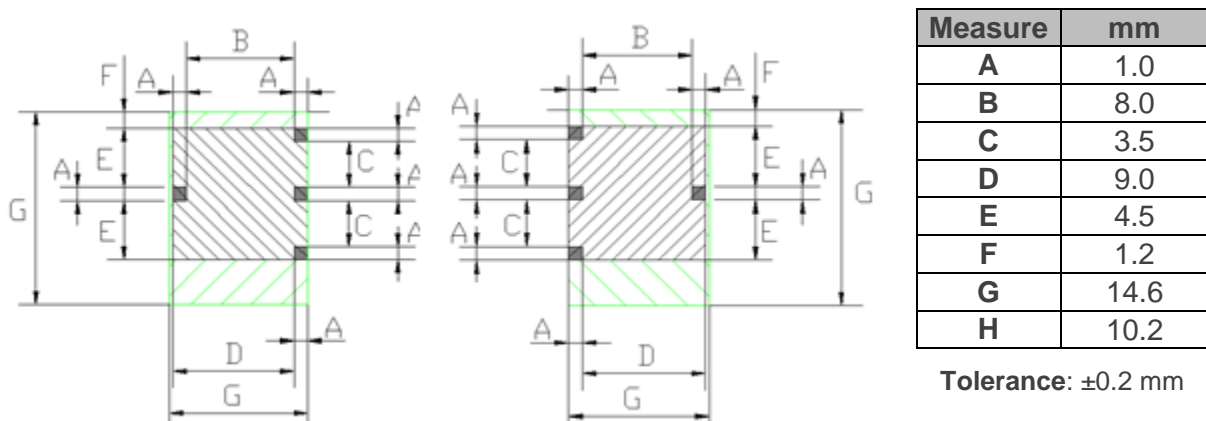

Figure 5 – Antenna Footprint Details

Other PCB form factors and configurations may require a different feeding configuration, feeding line dimensions and clearance areas. If you require support for the integration of the antenna in your design, please contact info@fractusantennas.com.

5. MATCHING NETWORK

The specs of a Fractus Antennas standard antenna are measured in their evaluation board, which is an ideal case. In a real design, components nearby the antenna, LCD's, batteries, covers, connectors, etc. affect the antenna performance. This is the reason why it is highly recommended placing pads compatible with 0402 and 0603 SMD components for a PI matching network as close as possible to the antenna feeding point. Do it in the ground plane area, not in the clearance area. This is a degree of freedom to tune the antenna once the design is finished and taking into account all elements of the system (batteries, displays, covers, etc.).

6. ASSEMBLY PROCESS

Figure 6 shows the back and front view of the Dual-band Reach Xtend™ chip antenna, and indicates the location of the feeding point and the mounting pads:

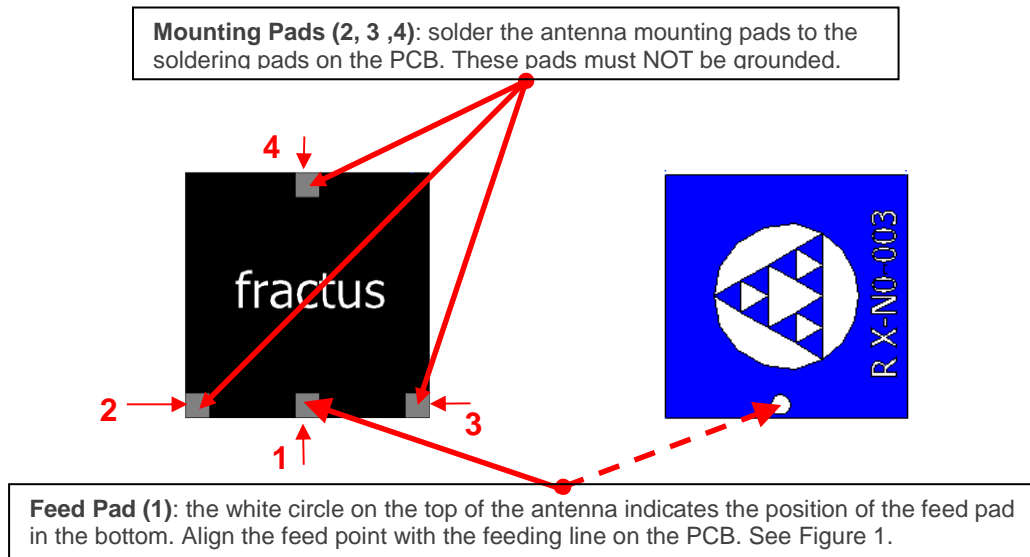

Figure 6 – Pads of the Fractus Dual-band Reach Xtend™ chip antenna.

As a surface mount device (SMD), this antenna is compatible with industry standard soldering processes. The basic assembly procedure for this antenna is as follows:

1. Apply a solder paste to the pads of the PCB. Place the antenna on the board.
2. Perform a reflow process according to the temperature profile detailed in Table 3, Figure 8 on page 12.
3. After soldering the antenna to the circuit board, perform a cleaning process to remove any residual flux. Fractus Antennas recommends conducting a visual inspection after the cleaning process to verify that all reflux has been removed.

The drawing below shows the soldering details obtained after a correct assembly process:

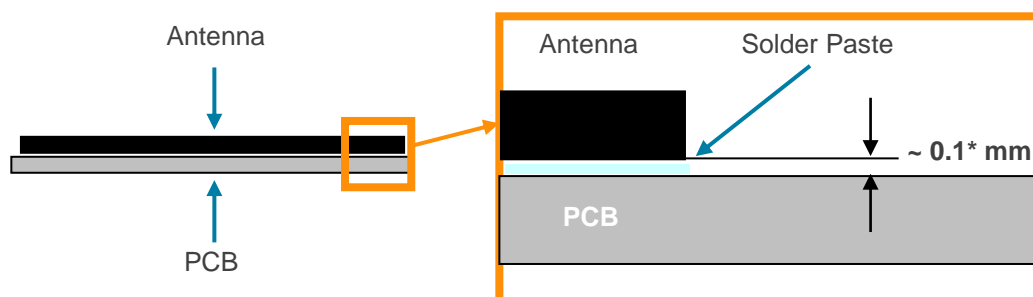

Figure 7 – Soldering Details.

NOTE(*): Solder paste thickness after the assembly process will depend on the thickness of the soldering stencil mask. A stencil thickness equal to or larger than **127 microns (5 mils)** is required.

The Fractus Dual-band Reach Xtend™ antenna should be assembled following either Sn-Pb or Pb-free assembly processes. According to the Standard **IPC/JEDEC J-STD-020C**, the temperature profile suggested is as follows:

Phase	Profile features	Pb-Free Assembly (SnAgCu)
RAMP-UP	Avg. Ramp-up Rate (T _{smax} to T _p)	3 °C / second (max.)
PREHEAT	<ul style="list-style-type: none"> - Temperature Min (T_{smin}) - Temperature Max (T_{smax}) - Time (t_{smin} to t_{smax}) 	150 °C 200 °C 60-180 seconds
REFLOW	<ul style="list-style-type: none"> - Temperature (T_L) - Total Time above T_L (t_L) 	217 °C 60-150 seconds
PEAK	<ul style="list-style-type: none"> - Temperature (T_p) - Time (t_p) 	260 °C 20-40 seconds
RAMP-DOWN	Rate	6 °C/second max
Time from 25 °C to Peak Temperature		8 minutes max

Table 3 – Recommended soldering temperatures.

Next graphic shows temperature profile (grey zone) for the antenna assembly process in reflow ovens.

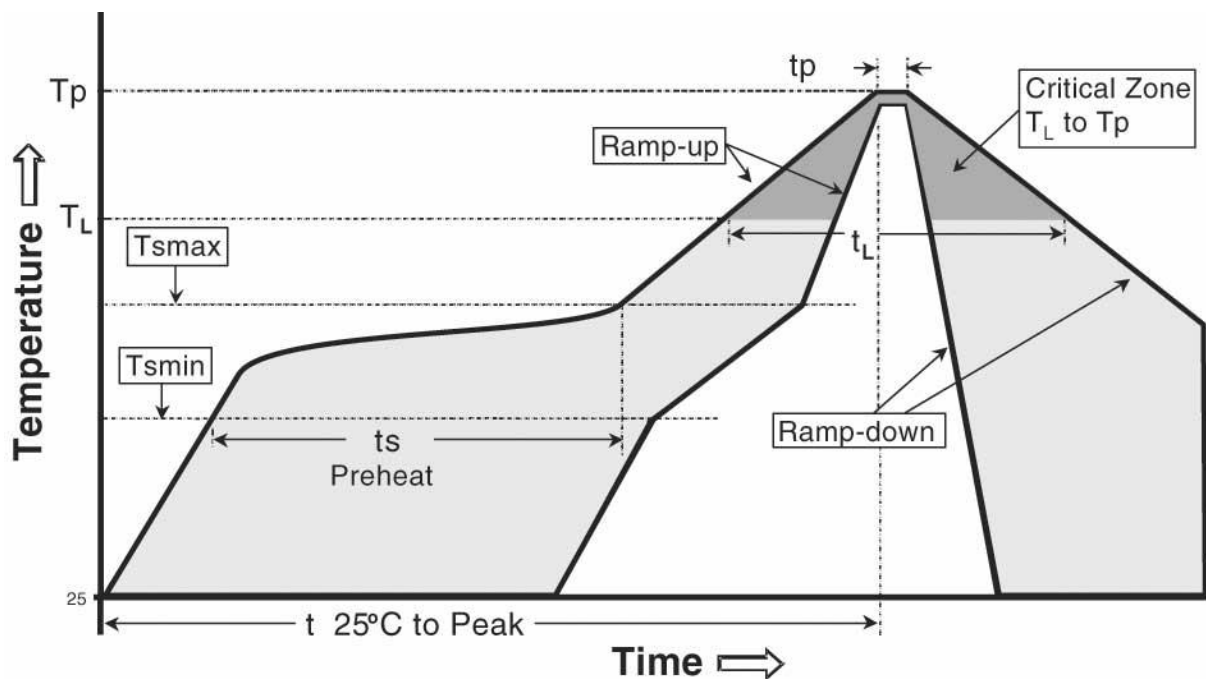

Figure 8 – Temperature profile.

7. PACKAGING

The Fractus Dual-band Reach Xtend™ chip antenna is available in tape and reel packaging.

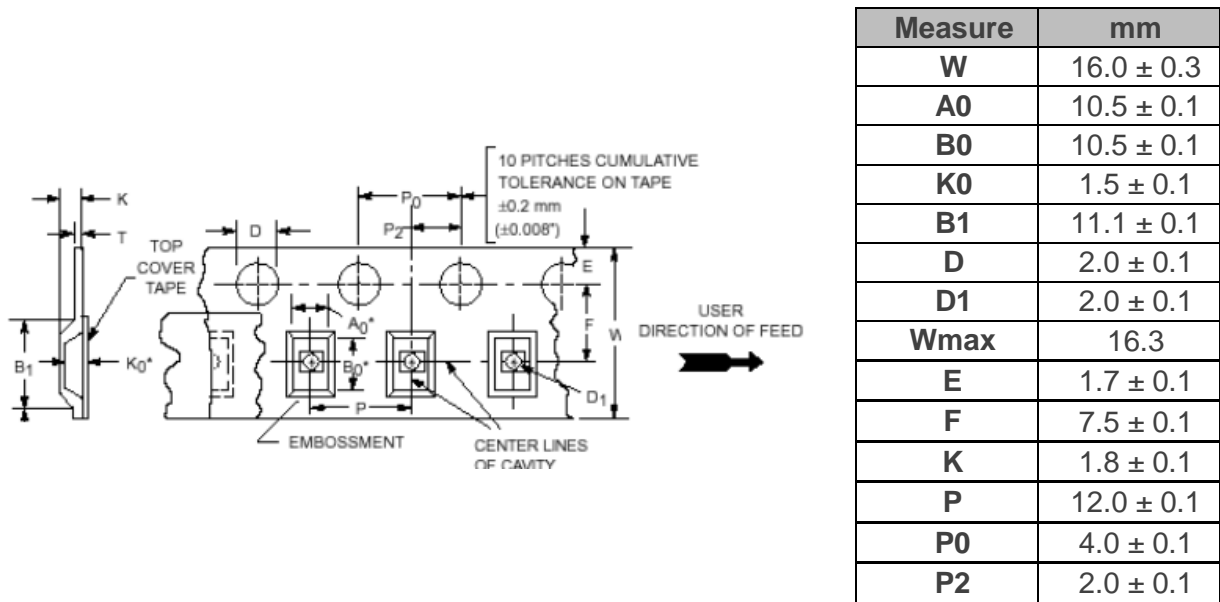

Figure 9 – Tape Dimensions and Tolerances.

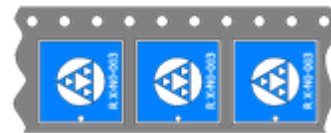
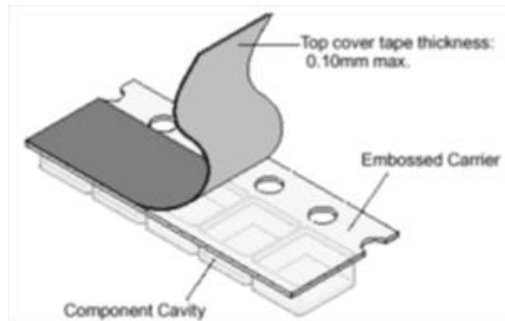
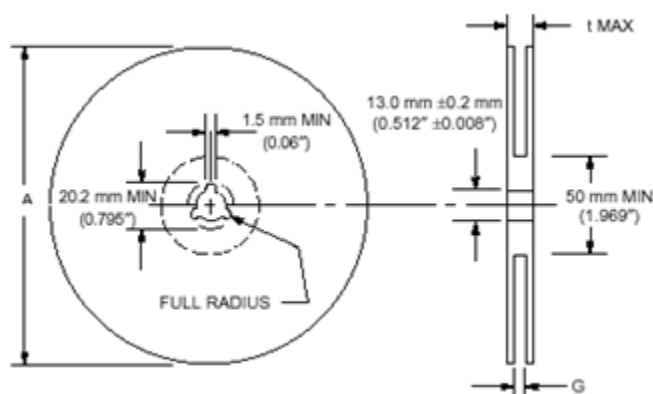

Figure 10 – Images of the tape.



Measure	mm
A max	330.0 ± 1.0
G	17.5 ± 0.2
t max	21.5 ± 0.2

Reel Capacity: 2500 antennas

Figure 11 – Reel Dimensions and Capacity.