

PFC-375 Series

Univerter® Power Factor Correction Module

375 Watt PFC Front End

The Univerter PFC-375 Power Factor Correction modules are AC to DC converters that operate from a wide range of AC input voltages and frequencies with extremely high conversion efficiency and near unity power factor. The PFC-375 produces an output of 375 VDC suitable for driving 300V input DC-DC converters, motors, pumps and a host of other loads. The wide AC input voltage range and frequency range are 85 to 265 VAC and 47 to 800 Hz respectively, making this product suitable for land, sea and air based applications requiring AC to DC conversion with line harmonic reduction or PFC. Typical applications include 115/230 VAC, 50/60 Hz systems and 115 VAC, 400 Hz or 360-800 Hz military and commercial aircraft power systems requiring MIL-STD-704 or DO-160 compliance. These compact, rugged modules use advanced electrical design and thermal management techniques to make them suitable for harsh environments and thermally challenged applications.



Compact 1/2 Brick Package
2.4 x 2.3 x 0.5 in.

FEATURES

- Optimized for Airborne and other Harsh Environment Applications
- 85-265 VAC INPUT, 47-800Hz
- 375VDC Output
- Efficiency 94% typical 115VAC, 400Hz Input, 97% typical at 230VAC, 50Hz input
- Extremely High Power Factor and Low THD
- Potted Module with Metal Substrate Technology
- -40°C to +100°C Base Plate Rated – No Output Power Derating
- Available in Lead Free ROHS Compliant or SnPb Solder Versions
- Ride-Through Time is essentially unlimited, depends only on the Bulk Cap Voltage

MODEL SELECTION

PFC-375 - -

Standard Options (0, 1, 2 or 3 characters):

Blank: Standard
A: Vaux Option
T: Extended Operating Temp Range
-55 to +100°C
C: Conformal coating

Solder Option (Blank or 2 characters):

Blank: Standard SnPb Solder
LF: ROHS Compliant Lead Free Solder Option
RL: Tin-Free Construction (SnPb Solder – no pure tin)

Special Configurations (3 characters):

Assigned by Astrodyne

PFC-375 Series

375 Watt Power Factor Correction Module
375 VDC Output, ½ Brick Package



ABSOLUTE MAXIMUM RATINGS Exceeding absolute maximum ratings may cause permanent damage or reduce reliability					
PARAMETER	OPTION	MINIMUM	MAXIMUM	UNITS	CONDITIONS
Input Voltage (AC1 to AC2)			265	VAC	Continuous
Input Voltage (AC1 to AC2)			311	VAC	100ms max.
Circuit-to-Case Voltage			2500	Vdc	
Storage Temperature	Standard	-55	110	°C	
Operating Temperature	Standard	-40	100	°C	Baseplate
Operating Temperature	T	-55	100	°C	Baseplate
Soldering Temperature			260	°C	< 5 sec

SPECIFICATIONS

Electrical specifications apply for in = 115Vac, 60 Hz to 400 Hz Full Load, Tc = 25 °C and external application circuit components shown in figure 1, unless specified otherwise.

INPUT SPECIFICATIONS	MINIMUM	TYPICAL	MAXIMUM	UNITS	CONDITIONS
Input Voltage	85	115/230	265	VAC	
Input Line Frequency	47	50/60/400	800	Hz	
Power Factor	0.99		1.0		60 Hz
Total Harmonic Distortion		<5%		%	Conforming to IEC 1000-3-2
Maximum Input Current		3.5	4.5	Arms	Vin = 90VAC, Full Load, Tc = 25°C
Inrush Current					
Input 115 Vac		15		Apeak	Thermistor Temperature 25°C
Input 230 Vac		30		Apeak	Thermistor Temperature 25°C
Start-up Voltage			80	VAC	
*Ride Through time		75		ms	Vin = 115VAC, 60Hz

*Note: Ride Through is indefinite if output is held above 220V.

PFC-375 Series

375 Watt Power Factor Correction Module
375 VDC Output, ½ Brick Package



OUTPUT SPECIFICATIONS	MINIMUM	TYPICAL	MAXIMUM	UNITS	CONDITIONS
Output Voltage	370	375	380	Vdc	Vin = 115VAC, Tc = 25°C
Output Over Voltage Protection			415	Vdc	Non-shutdown Vmax.
Output Current	0		1.0	ADC	
Output Current Limit		NONE			
Efficiency		94%		%	
Output Ripple		13		V p-p	Vin = 115VAC, f=60Hz
Vaux Output Voltage (OPTION-A)	10	12.5	18.0	Vdc	Vaux Load = 3mA

CONTROL SPECIFICATIONS	MINIMUM	TYPICAL	MAXIMUM	UNITS	CONDITIONS
LD ENA Threshold (Vout rising)	355	360	370	Vdc	
LD ENA threshold (Vout falling)	205	220	235	Vdc	
LD ENA Logic Low Current			20	mA	
LD ENA Logic Low Voltage			0.5	Vdc	

ISOLATION SPECIFICATIONS	MINIMUM	TYPICAL	MAXIMUM	UNITS	CONDITIONS
Input-to-Output Isolation		Non-isolated		Vdc	
Input-to-Case Isolation	2500			Vdc	
Output-to-Case Isolation	2500			Vdc	
Circuit-to-Case Capacitance		10		nF	

THERMAL/ MECHANICAL SPECIFICATIONS	MINIMUM	TYPICAL	MAXIMUM	UNITS	CONDITIONS
Thermal Shutdown Temperature	100	105	110	°C	Baseplate temperature
Thermal Shutdown Restart Temperature		90		°C	Baseplate temperature
Thermal Resistance, Case to Ambient		6.6		°C/W	Natural Convection in Free Air, No Heatsink, Tc = 100°C

PFC-375 Series

375 Watt Power Factor Correction Module
375 VDC Output, ½ Brick Package



Size	2.40 x 2.30 x 0.50	inch	1/2 Brick		
Weight	4.2	oz.			
EMC COMPLIANCE	EXTERNAL FILTER	COMPLIANCE			
RTCA DO-160	ASTRODYNE PN: FA250-5	RTCA DO-160 Section 21.3 Categories L and M			
RELIABILITY	MINIMUM	TYPICAL	MAXIMUM	UNITS	CONDITIONS
MTBF Prediction		2.0		M hrs	MIL-217F GB 25°C

PIN FUNCTION/DESCRIPTION

AC1, AC2

These are the AC input terminals. The input should be connected to a suitable filter such as the F250-5 in order for the PFC module to perform properly and to comply with applicable EMI/EMC performance standards. A suitable fuse and inrush limiting thermistor should be connected in series with the input as well.

+Out

This is the positive output terminal. It should be connected to the positive terminal of the bulk capacitor. The 375 VDC output will appear here with respect to the – Out terminal. The hold-up capacitor value ranges are provided in the specifications.

-Out

This is the PFC negative output terminal. It should be connected directly to the negative terminal of the hold up capacitor. The hold-up capacitor must be

located in close proximity to the PFC output terminals.

LD ENA

This terminal provides logic control to downstream DC/DC converters. The LD ENA signal will be an active low signal until the PFC output voltage reaches a specified value after the application of input voltage. It will switch logic state to open collector upon the PFC output reaching 340 Vdc. If AC power is lost or removed, the LD ENA will return to the low state when the PFC output drops to 220 Vdc. For most RO DC-DC products, it is not necessary to use the LD ENA terminal.

V AUX (Option A)

This terminal provides an “always on” 12.5V pull up capable of providing 3mA. The V AUX supply voltage is derived from the output and will be present as long as the bulk cap voltage remains above 180V.

PFC-375 Series

375 Watt Power Factor Correction Module

375 VDC Output, ½ Brick Package



APPLICATION DIAGRAM

The connection diagram below shows proper connections of the PFC-375 module to a typical application circuit including fuse, filter, bulk capacitor and inrush limiting thermistor.

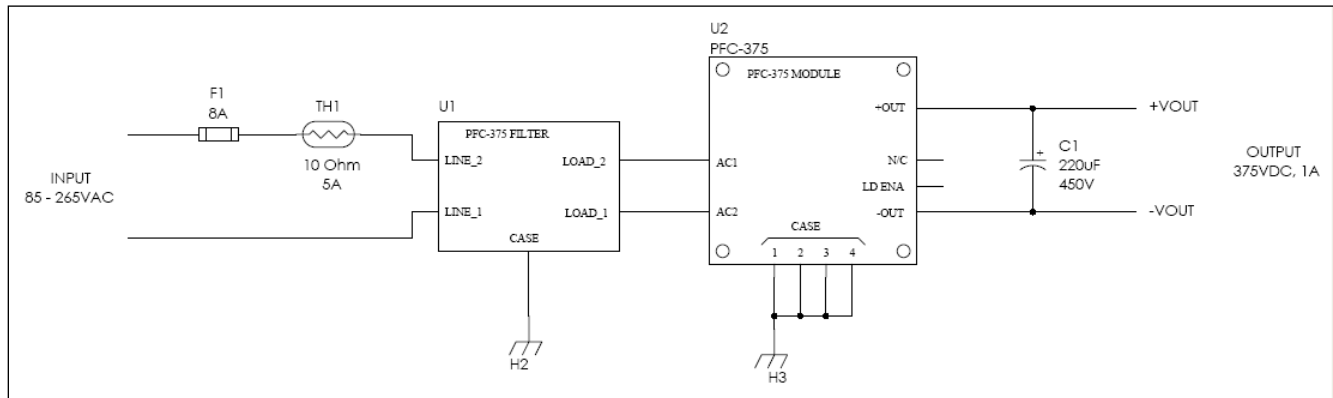

Figure 1 – Typical Application Circuit

The output is suitable for driving 300V input DC-DC converters up to 300W such as the uV300-164 Series products.

Additional applications information is available to assist in the selection of the external components.

EVALUATION BOARD

An Evaluation Board is available that demonstrates a complete AC-DC system using the PFC-375, FA250-5 filter and uV300-164 300W DC-DC converter.

Evaluation board features :

- PFC Output pinned out to 9 pin D-sub
- Series or Parallel Bulk Cap connections provided
- DC-DC has remote Sense capability – jumpers included, sense pinned out
- LED for low voltage DC Output indication included
- Test points for DC-DC Output measurement included
- BNC Connector for DC-DC ripple measurement included
- Vaux pinned out on EB
- Provision for current sharing and 3 phase operation

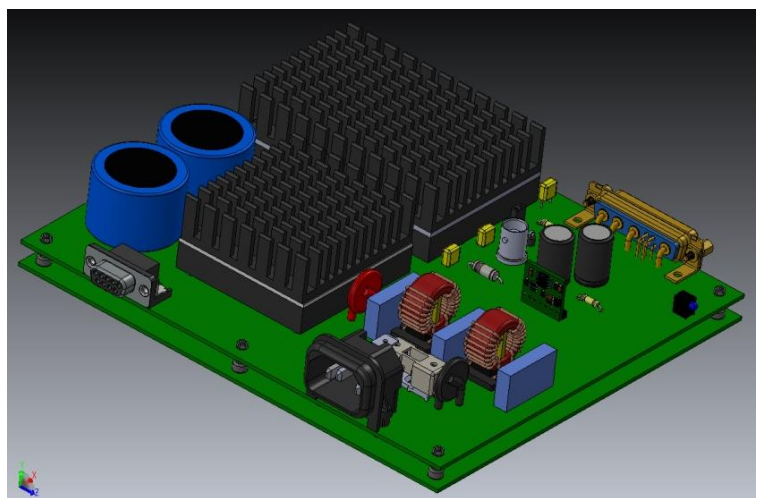

PFC-375 Series

375 Watt Power Factor Correction Module
375 VDC Output, 1/2 Brick Package

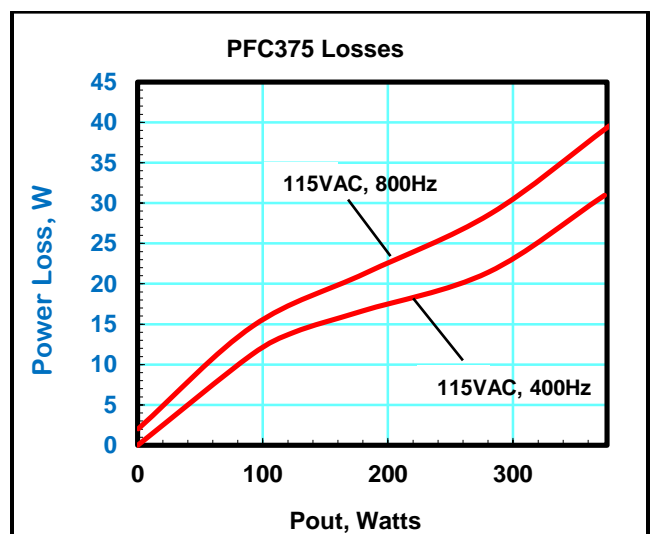
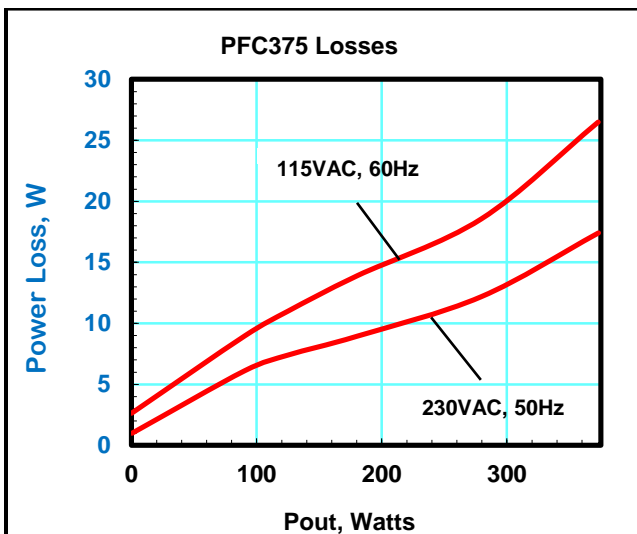
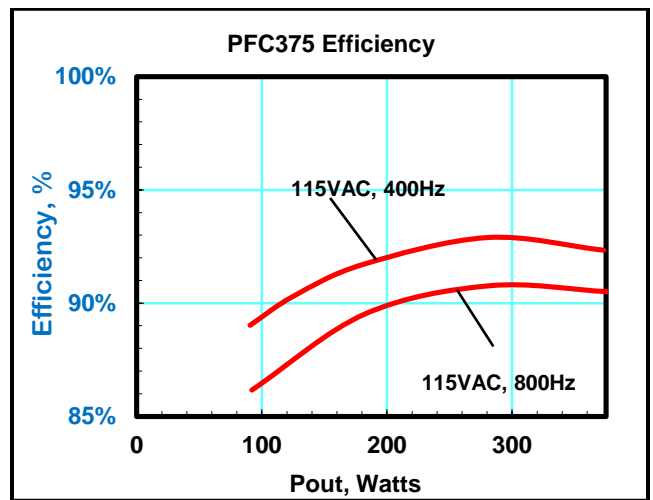
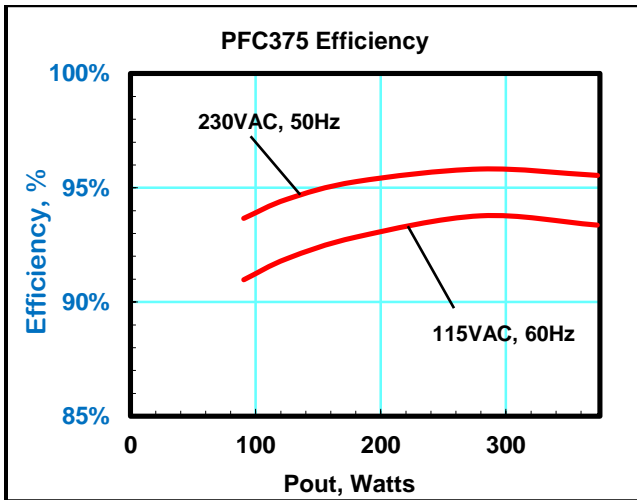
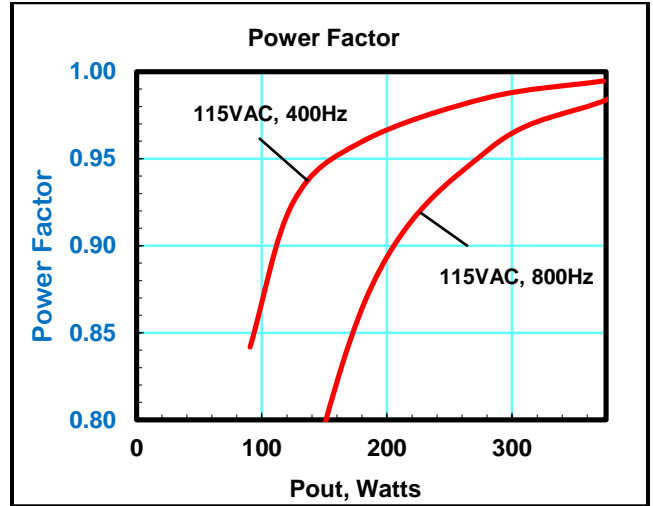
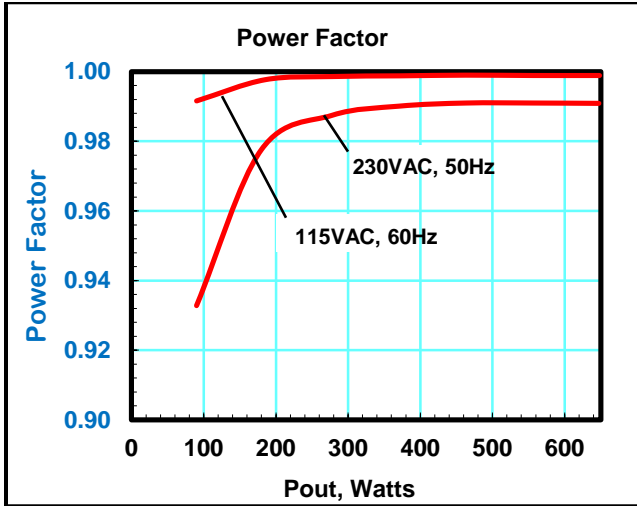

PFC-375 Series

375 Watt Power Factor Correction Module

375 VDC Output, ½ Brick Package



MECHANICAL DRAWING

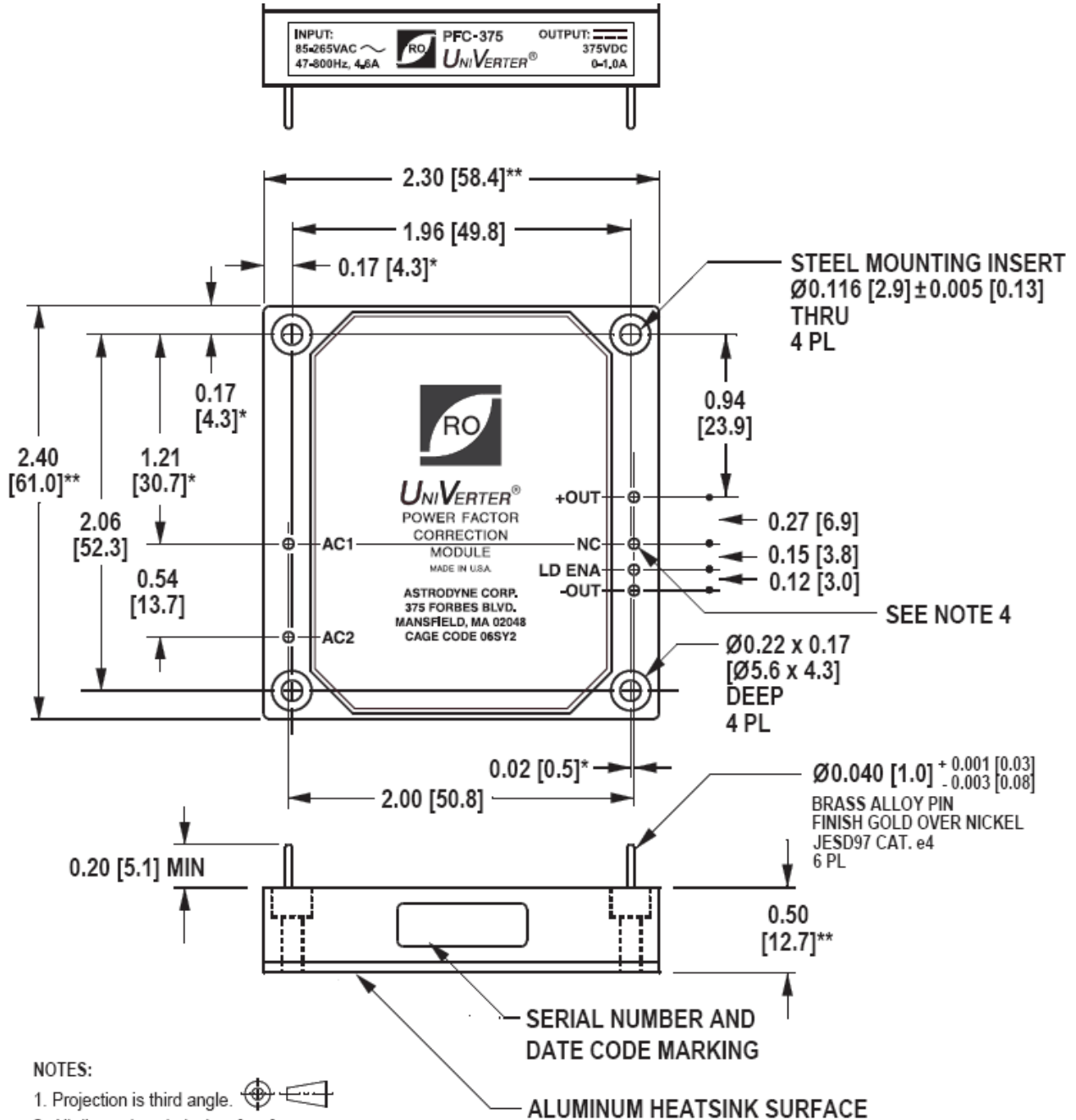

NOTES:

- Projection is third angle.
- All dimensions in inches [mm].
- Tolerance:
 - Tolerance on all dimensions unless specified otherwise: ±0.01 [0.25].
 - Tolerance on all dimensions marked with *: ±0.015 [0.4].
 - Tolerance on all dimensions marked with **: ±0.02 [0.5].
- VAUX when "A" option is ordered. Otherwise not connected.