

8	7	6	5	4	3	2	1
PART NUMBER	THICKNESS	MATERIAL	PLATING TYPE	PACKAGING			
67B5G2504506010R00	0.10mm	BeCu C17200	Au 1u" Over Ni 50~120u"	TAPE AND REEL			
				REEL DIAMETER	TAPE WIDTH (W)	PITCH (P)	QUANTITY / REEL
				330.2mm (13 inch)	16mm	8mm	1200pcs

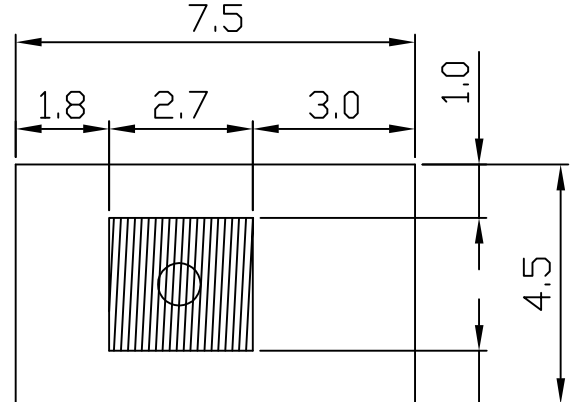

SOLDER PAD Dimension

Recommendation

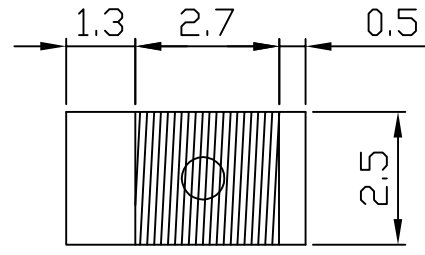
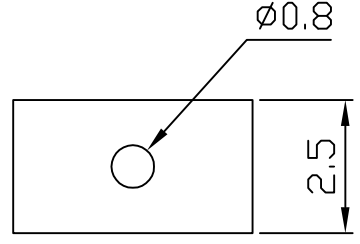
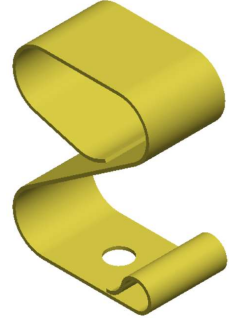
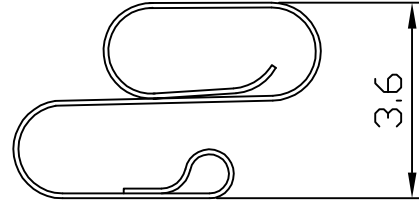
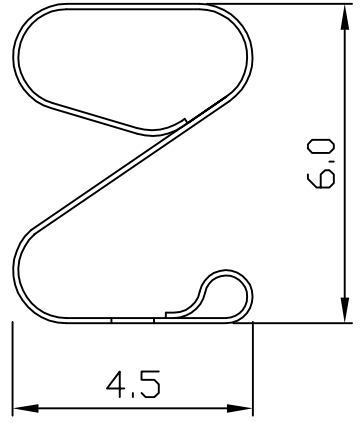
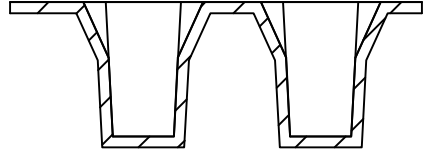
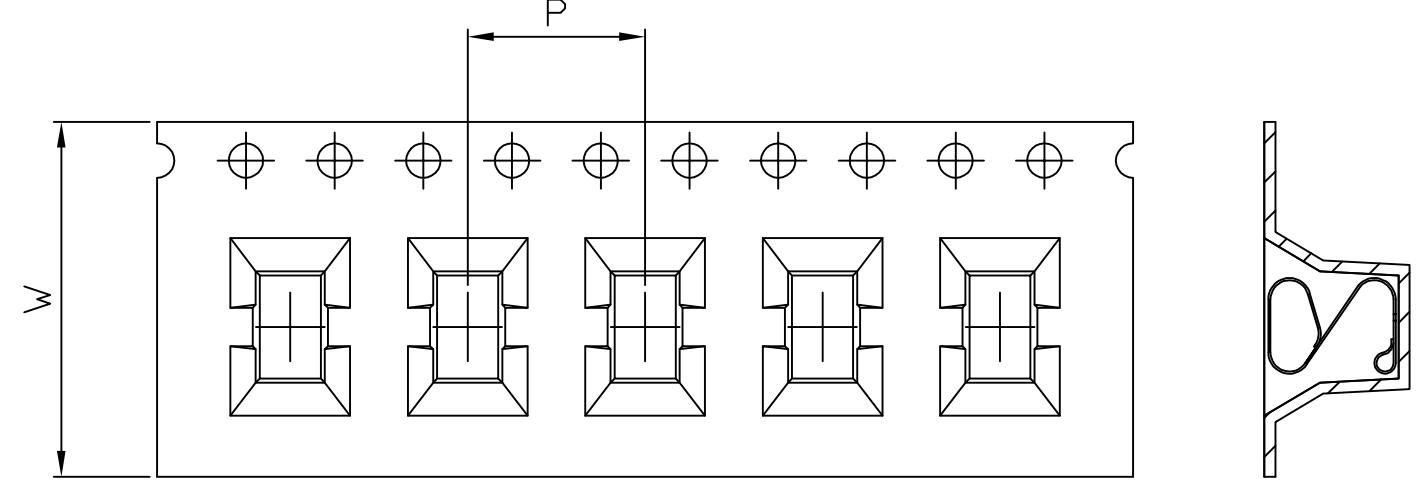

PART NUMBER CONFIGURATION:

67 B X X XXX XX XXX XX R XX

67 FOR GENERAL ELECTRONICS
68 FOR AUTOMOTIVE ELECTRONICS

MATERIAL: BECU

SHAPE TYPE

PLATING TYPE

PART WIDTH

VERSION CODE

PACKAGING: TAPE&REEL

PART THICKNESS

PART HEIGHT

PART LENGTH

UNITS: MM [INCH]

TOLERANCES:

X.X = ±0.4
X.XX = ±0.2
X.XXX = ±0.1

ANGULAR:
X° = ±3°
X.X° = ±1.0°



3RD ANGLE PROJECTION

DESIGNED IN SOLIDWORKS

SCALE: 5:1

SHEET 1 OF 1

SIZE B

LAIRD DRAWING NUMBER:

B5G-25X45X060-SALES

THIS IS AN UNCONTROLLED SALES DRAWING. THE DIMENSIONAL CHARACTERISTICS AND TOLERANCES OF THIS PART SHOWN ON THIS DRAWING AS A REFERENCE TO THE DIMENSIONAL SPECIFICATIONS OF THE LAIRD STANDARD PRODUCTION DRAWING FOR THIS PART. ANY SUBSEQUENT CHANGES TO THE STANDARD PART SPECIFICATION WILL SUPERSEDE THIS SALES DRAWING.