

RECOMMENDED APPLICABLE FPC LAYOUT
(THICKNESS: 0.3±0.03)

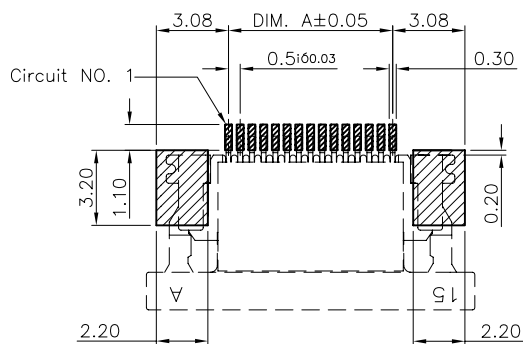

PCB PATTERN LAYOUT

NOTES:

- MATERIAL:
 - HOUSING: THERMOPLASTIC, HIGH TEMP., UL94V-0;
 - ACTUATOR: THERMOPLASTIC, HIGH TEMP., UL94V-0;
 - CONTACT: COPPER ALLOY
 - FITTING NAIL: COPPER ALLOY
- FINISH:
 - CONTACT: 50u" MIN. NICKEL UNDERPLATING OVERALL. N:100u" MIN. MATT TIN UNDERPLATING OVERALL. 1:GOLD FLASH PLATING ON CONTACT AND SOLDER AREA D:30U" GOLD ON CONTACT AND SOLDER AREA
 - FITTING NAIL: 50u" MIN. NICKEL UNDERPLATING OVERALL. N:100u" MIN. MATT TIN UNDERPLATING OVERALL. 1:GOLD FLASH PLATING D:GOLD FLASH
- REFLOW SOLDER CAPABLE TO 260°C PER ACES SPEC.
- SPEC. PLS. REFER TO PS-50541-XXXX-XXX
- THE PACKING DRAWING PLS REFER TO 88716-XXXX-TRP.
- PART NUMBER

P/N LEGEND
50542-XXX X X-XXX

XXX	HOUSING COLOR.	ACTUATOR COLOR.
001	BLACK	WHITE

NO OF CKTS
PACKING
0: TAPE&REEL
1: TUBE

PLATING
N: MATE TIN(LEAD FREE)
1: GOLD FLASH OVER ALL(LEAD FREE)
D: 30U" GOLD ON CONTACT AND SOLDER AREA

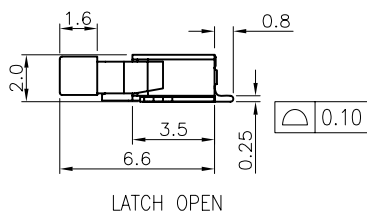
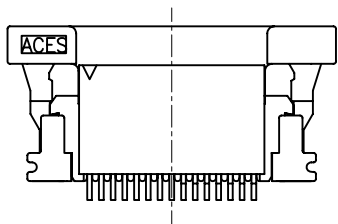
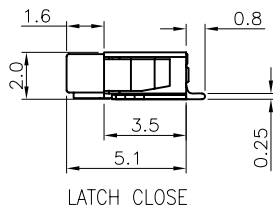
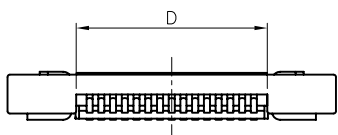
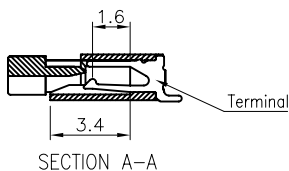
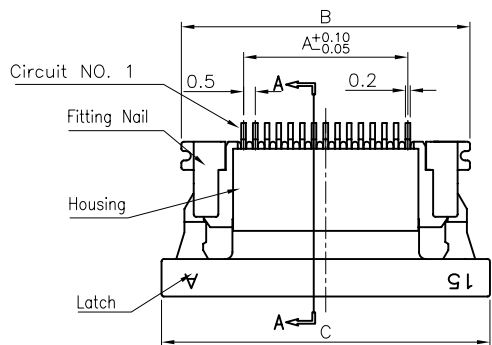

CKT	Dim A	Dim B	Dim C	Dim D	CKT	Dim A	Dim B	Dim C	Dim D
4	1.5	6.80	8.5	2.65	35	17.0	22.30	24.0	18.15
5	2.0	7.30	9.0	3.15	36	17.5	22.80	24.5	18.65
6	2.5	7.80	9.5	3.65	37	18.0	23.30	25.0	19.15
7	3.0	8.30	10.0	4.15	38	18.5	23.80	25.5	19.65
8	3.5	8.80	10.5	4.65	39	19.0	24.30	26.0	20.15
9	4.0	9.30	11.0	5.15	40	19.5	24.80	26.5	20.65
10	4.5	9.80	11.5	5.65	41	20.0	25.30	27.0	21.15
11	5.0	10.30	12.0	6.15	42	20.5	25.80	27.5	21.65
12	5.5	10.80	12.5	6.65	43	21.0	26.30	28.0	22.15
13	6.0	11.30	13.0	7.15	44	21.5	26.80	28.5	22.65
14	6.5	11.80	13.5	7.65	45	22.0	27.30	29.0	23.15
15	7.0	12.30	14.0	8.15	46	22.5	27.80	29.5	23.65
16	7.5	12.80	14.5	8.65	47	23.0	28.30	30.0	24.15
17	8.0	13.30	15.0	9.15	48	23.5	28.80	30.5	24.65
18	8.5	13.80	15.5	9.65	49	24.0	29.30	31.0	25.15
19	9.0	14.30	16.0	10.15	50	24.5	29.80	31.5	25.65
20	9.5	14.80	16.5	10.65	51	25.0	30.30	32.0	26.15
21	10.0	15.30	17.0	11.15	52	25.5	30.80	32.5	26.65
22	10.5	15.80	17.5	11.65	53	26.0	31.30	33.0	27.15
23	11.0	16.30	18.0	12.15	54	26.5	31.80	33.5	27.65
24	11.5	16.80	18.5	12.65	55	27.0	32.30	34.0	28.15
25	12.0	17.30	19.0	13.15	56	27.5	32.80	34.5	28.65
26	12.5	17.80	19.5	13.65	57	28.0	33.30	35.0	29.15
27	13.0	18.30	20.0	14.15	58	28.5	33.80	35.5	29.65
28	13.5	18.80	20.5	14.65	59	29.0	34.30	36.0	30.15
29	14.0	19.30	21.0	15.15	60	29.5	34.80	36.5	30.65
30	14.5	19.80	21.5	15.65	61	30.0	35.30	37.0	31.15
31	15.0	20.30	22.0	16.15	62	30.5	35.80	37.5	31.65
32	15.5	20.80	22.5	16.65	63	31.0	36.30	38.0	32.15
33	16.0	21.30	23.0	17.15	64	31.5	36.80	38.5	32.65
34	16.5	21.80	23.5	17.65	65	32.0	37.30	39.0	33.15

一般公差 TOLERANCES X ±0.5 XX ±0.15 X ±0.25 XXX ±0.1 ANGLES ±2°	宏致電子股份有限公司 Aces Electronics Co.,Ltd.	
檢驗尺寸標示 SYMBOLS (M) INDICATE CLASSIFICATION DIMENSION (C) MARK IS CRITICAL DIM. (M) MARK IS MAJOR DIM.	品名 (TITLE) 0.5mm ZIF FPC CONN. SMT R/A B/C TYPE	製圖 (DR) 14/12/09 LLJ 審核 (CHKD) ANDREW 核准 (APPD) SIMON
圖號 (DWG NO.) 50542-XXXXX-XXX	比例 (SCALE) 3:1	單位 (UNITS) mm
表面處理 (FINISH)	張數 (SHEET) 1 OF 1	尺寸 (SIZE) A4 頁數 (REV) C