

ORDER NO.	WOODHEAD NO.	COLOR
130147-0295	29W47MB-P	YELLOW

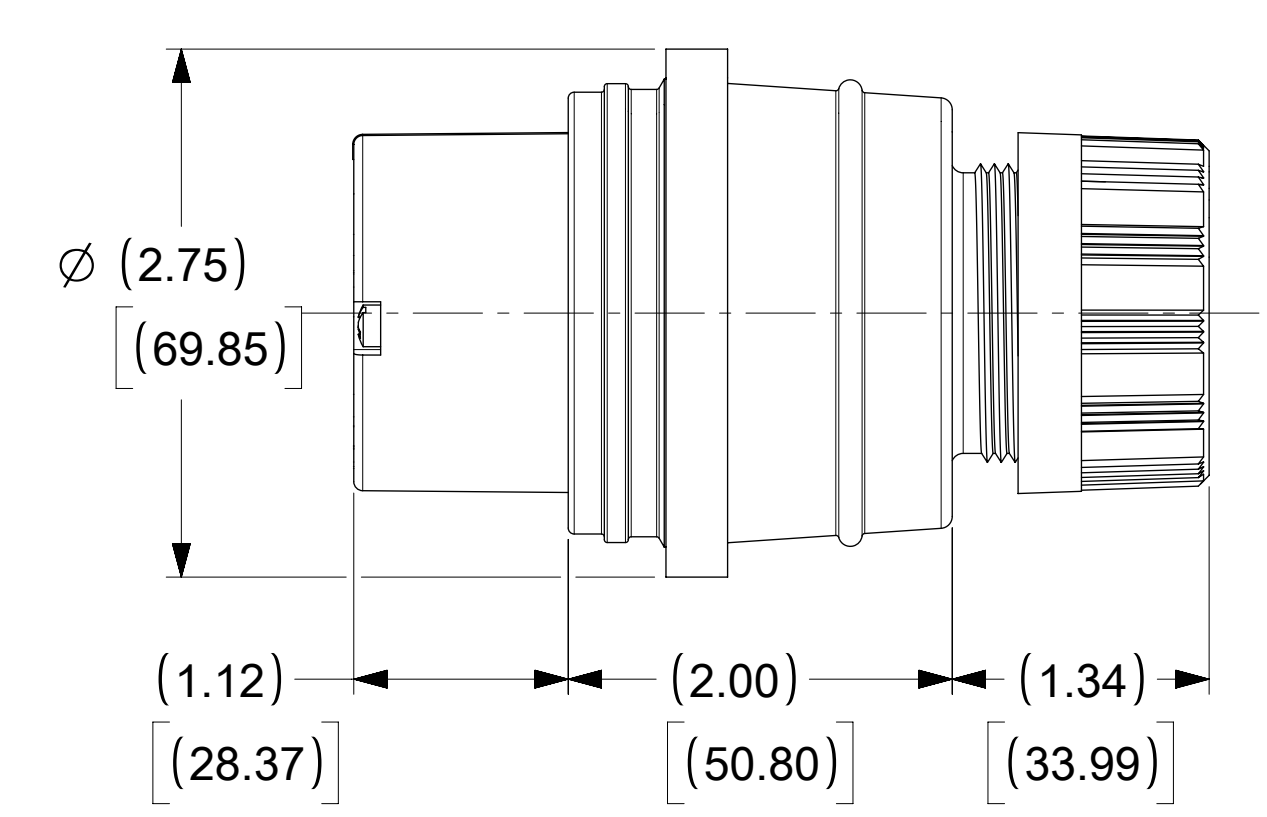
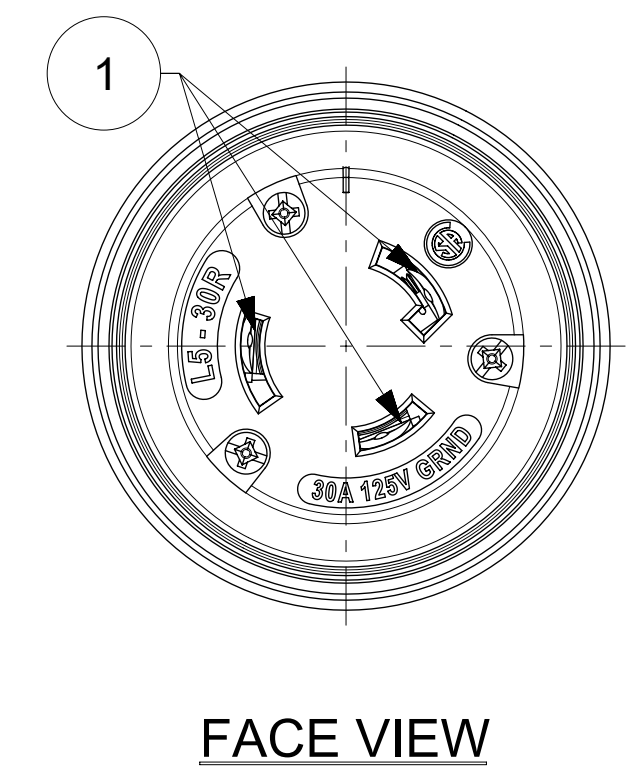
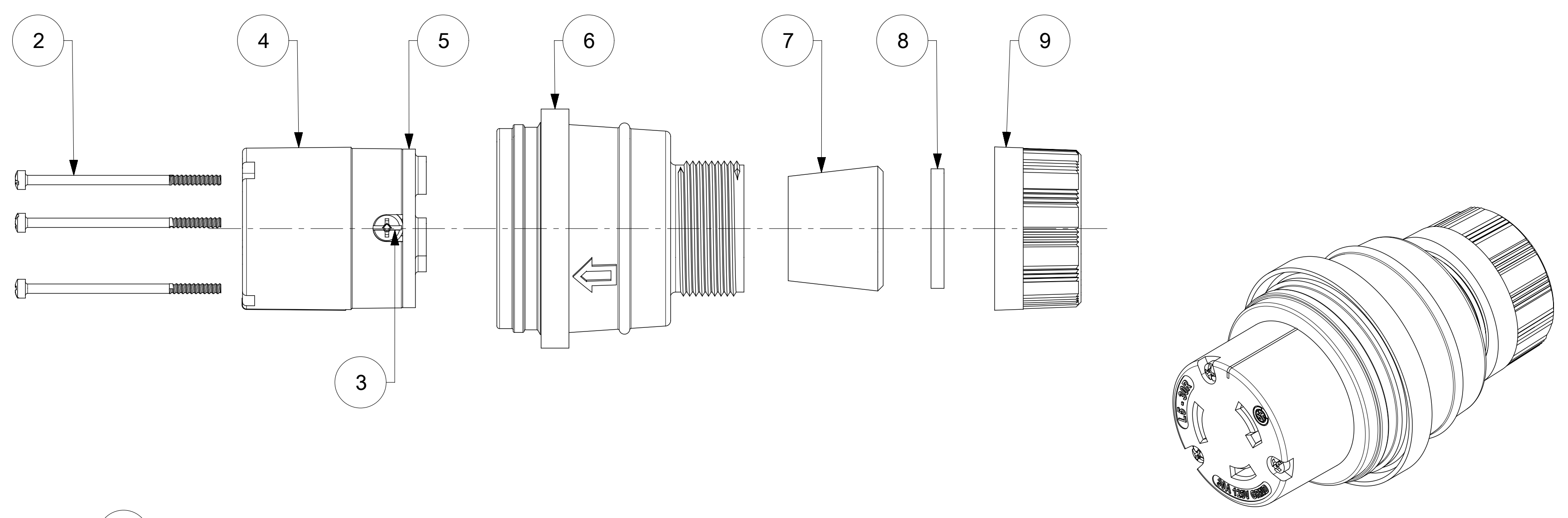

ITEM NO.	DESCRIPTIONS	MATERIAL	QTY.
1	BLADE	BRASS, NICKEL PLATED	3
2	RETAINING SCREWS	STAINLESS STEEL	3
3	CLAMP AND TERMINAL SCREW ASSY	BRASS, ZINC PLATED	3
4	INSERT	NYLON	1
5	TERMINAL COVER	POLYCARBONATE	1
6	HOUSING	SILICON WITH NYLON THREAD	1
7	GROMMET	RUBBER	4
8	FRICTION RING	NYLON	1
9	COMPRESSION NUT	NYLON	1

SYMBOLS DIMENSION UNITS: INCH[MM] SCALE: NTS GENERAL TOLERANCES (UNLESS SPECIFIED): 4 PLACES ± 3 PLACES ± 2 PLACES ± 1 PLACE ± 0 PLACES ± ANGULAR TOL ± ° DRAFT WHERE APPLICABLE MUST REMAIN WITHIN DIMENSIONS		THIS DRAWING CONTAINS INFORMATION THAT IS PROPRIETARY TO MOLEX ELECTRONIC TECHNOLOGIES, LLC AND SHOULD NOT BE USED WITHOUT WRITTEN PERMISSION CURRENT REV DESC: RELEASED EC NO: 614382 DRWN: DSOPPIN 2018/12/27 CHK'D: DNGUYEN62 2019/04/17 APPR: HKNEELAND 2019/04/17 INITIAL REVISION: DRWN: DSOPPIN 2018/12/27 APPR: HKNEELAND 2019/04/17 THIRD ANGLE PROJECTION DRAWING SERIES: C-SIZE 130147		 WATERTITE CONNECTOR MOTOR BASE 2P3W L5-30 PRODUCT CUSTOMER DRAWING DOCUMENT NUMBER: 1301470295 DOC TYPE: PSD DOC PART: 000 REVISION: A MATERIAL NUMBER: SEE TABLE CUSTOMER: GENERAL MARKET SHEET NUMBER: 1 OF 1	
---	--	---	--	--	--