

AC Filter for PCB Mounting Cost Optimized



See below:

**Approvals and Compliances**

**Description**

- Line filter in standard and medical version
- 1-stage
- standard attenuation

**Characteristics**

- Cost-saving plastic housing
- Designed for standard applications
- Protection against interference voltage from the mains
- Possible interferences generated in the equipment are strongly attenuated
- For standard applications
- Suitable for use in equipment according to IEC/UL 62368-1

**Other versions on request**

- Version with wire connection
- Medical Version (M80)

**References**

Alternative: Standard version

**Weblinks**

[pdf data sheet](#), [html datasheet](#), [General Product Information](#), [Approvals](#), [Distributor-Stock-Check](#), [Detailed request for product](#), [Microsite](#)

**Technical Data**

Ratings IEC	0.6 - 6 A @ Ta 40 °C / 250 VAC; 50 Hz	Line Filter	Standard and Medical Version, IEC 60939, UL 1283, CSA C22.2 no. 8
Ratings UL/CSA	0.6 - 6 A @ Ta 40 °C / 125 VAC; 60 Hz		<a href="#">Technical Details</a>
Leakage Current	standard < 0.25 mA (250 V / 60 Hz) medical < 5 µA (250 V / 60 Hz)	MTBF	> 200'000h acc. to MIL-HB-217 F
Dielectric Strength	> 1.7 kVDC between L-N > 2.7 kVDC between L/N-PE Test voltage (2 sec)		
Allowable Operation Temperature	-25 °C to 85 °C		
Climatic Category	25/085/21 acc. to IEC 60068-1		
Protection Class	Suitable for appliances with protection class I acc. to IEC 61140		
Terminal	For PCB mounting, tin-plated		
Material	Thermoplastic, black, UL 94V-0		



**Approvals and Compliances**

Detailed information on product approvals, code requirements, usage instructions and detailed test conditions can be looked up in [Details about Approvals](#)

SCHURTER products are designed for use in industrial environments. They have approvals from independent testing bodies according to national and international standards. Products with specific characteristics and requirements such as required in the automotive sector according to IATF 16949, medical technology according to ISO 13485 or in the aerospace industry can be offered exclusively with customer-specific, individual agreements by SCHURTER.



## Approvals

The approval mark is used by the testing authorities to certify compliance with the safety requirements placed on electronic products.  
Approval Reference Type: FPP2

Approval Logo	Certificates	Certification Body	Description
	VDE Approvals	VDE	Certificate Number: 40004673
	UL Approvals	UL	UR File Number: E72928



## Product standards

Product standards that are referenced

Organization	Design	Standard	Description
	Designed according to	IEC 60939	Passive filters for suppressing electromagnetic interference
	Designed according to	UL 1283	Electromagnetic interference filters
	Designed according to	CSA C22.2 no. 8	Electromagnetic interference (EMI) filters







## Application standards

Application standards where the product can be used

Organization	Design	Standard	Description
	Designed for applications acc.	IEC/UL 62368-1	Audio/video, information and communication technology equipment - Part 1: Safety requirements
	Designed for applications acc.	IEC 60601-1	Medical electrical equipment - Part 1: General requirements for basic safety and essential performance

## Compliances

The product complies with following Guide Lines

Identification	Details	Initiator	Description
	CE declaration of conformity	SCHURTER AG	The CE marking declares that the product complies with the applicable requirements laid down in the harmonisation of Community legislation on its affixing in accordance with EU Regulation 765/2008.
	UKCA declaration of conformity	SCHURTER AG	The UKCA marking declares that the product complies with the applicable requirements laid down in the British Amendment of Regulation (EC) 765/2008.
	RoHS	SCHURTER AG	Directive RoHS 2011/65/EU, Amendment (EU) 2015/863
	China RoHS	SCHURTER AG	The law SJ / T 11363-2006 (China RoHS) has been in force since 1 March 2007. It is similar to the EU directive RoHS.
	REACH	SCHURTER AG	On 1 June 2007, Regulation (EC) No 1907/2006 on the Registration, Evaluation, Authorization and Restriction of Chemicals 1 (abbreviated as "REACH") entered into force.
	Medical Equipment	SCHURTER AG	Suitable for use in medical equipment according to IEC/UL 60601-1 (1 MOOP, 1 MOPP)

## Dimension [mm]

Case 13P

Case 18P

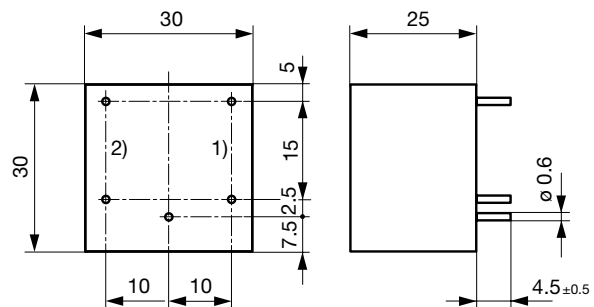
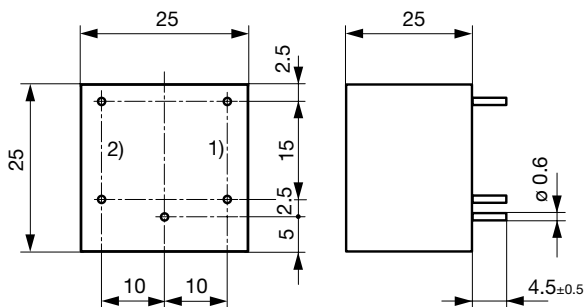

Case 24P

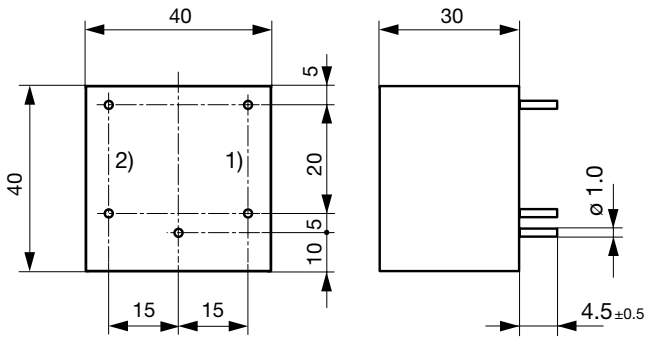

- 1) Line
- 2) Load

Diagrams

S1 standard version

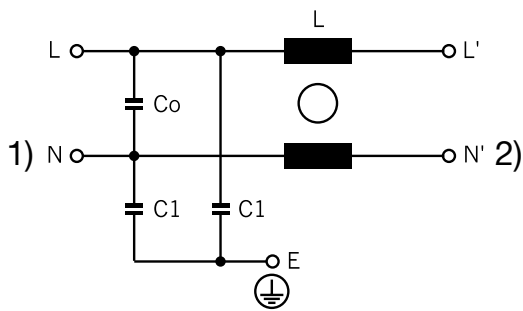

- 1) Line
- 2) Load

S2 medical version

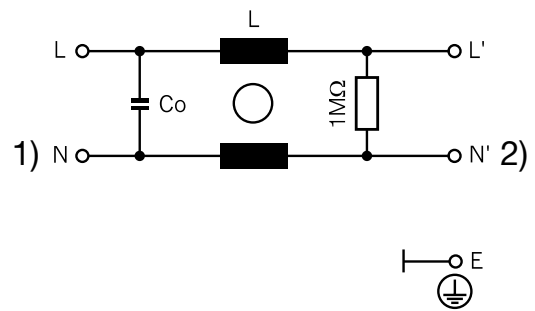

- 1) Line
- 2) Load

**Attenuation Loss**

--- 50Ω differential mode \_\_\_\_ 50Ω common mode

Standard version

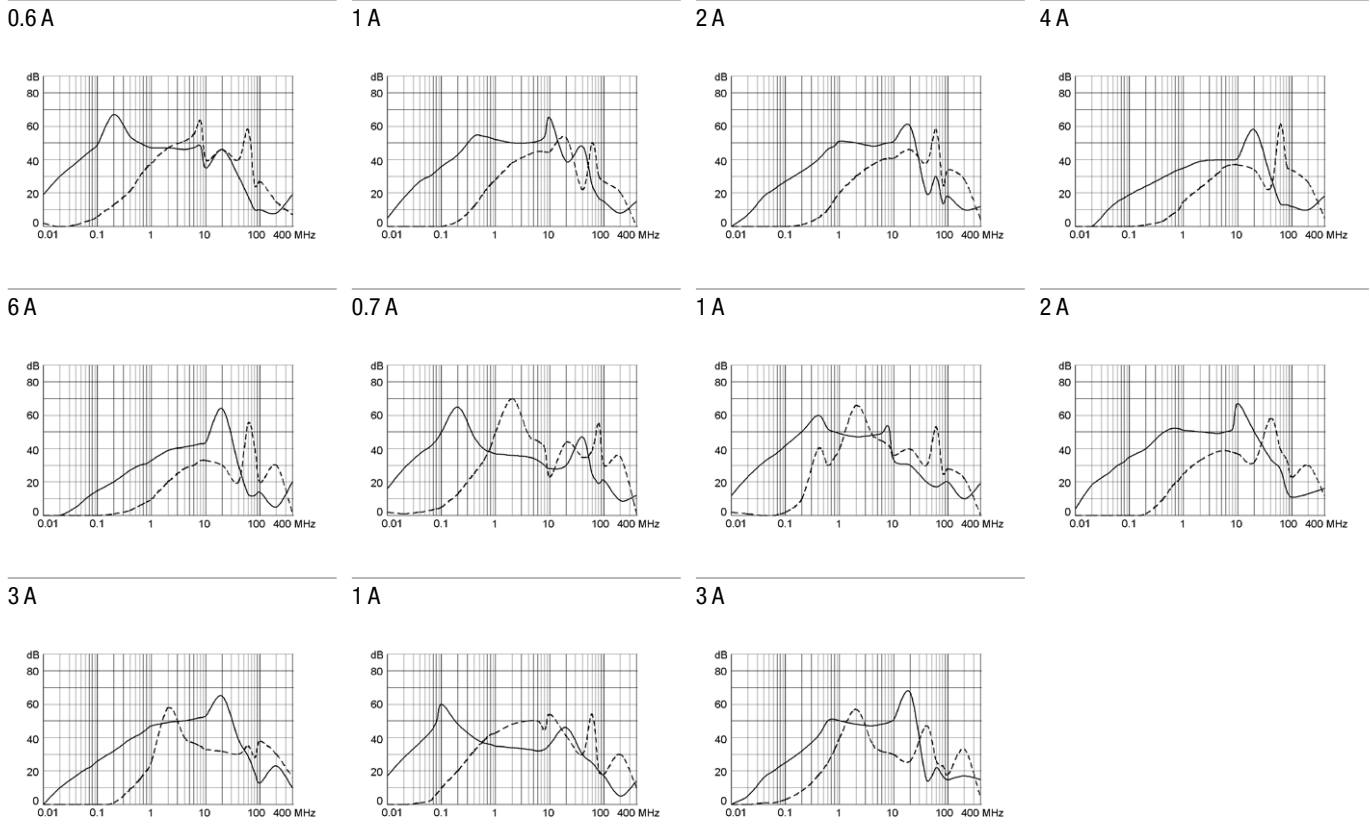

Medical version (M5)

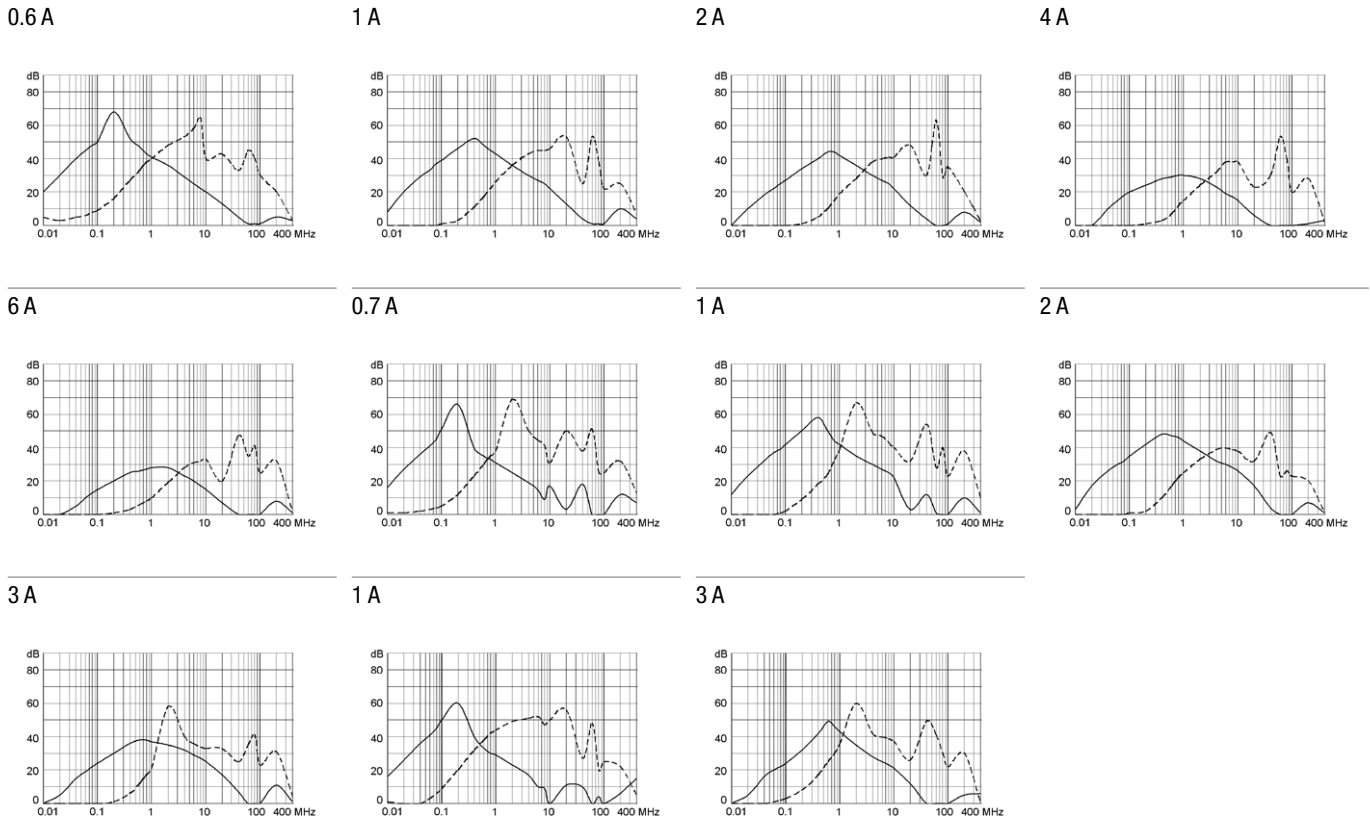

All Variants

Rated Current [A]	Filter-Type	L [mH]	Co / C2 (X2) [µF]	C1 (Y2) [nF]	Diagram	Weight [g]	Housing	Order Number	
0.6	Standard version	2 x 40	0.015	2.2	S1	27 g	13P	5500.2000	■
1	Standard version	2 x 10	0.015	2.2	S1	27 g	13P	5500.2001	■
2	Standard version	2 x 4	0.015	2.2	S1	27 g	13P	5500.2002	■
4	Standard version	2 x 1.5	0.015	2.2	S1	27 g	13P	5500.2003	■
6	Standard version	2 x 0.8	0.015	2.2	S1	35 g	13P	5500.2004	
0.7	Standard version	2 x 40	0.015	2.2	S1	32 g	18P	5500.2005	
1	Standard version	2 x 20	0.022	2.2	S1	32 g	18P	5500.2006	
2	Standard version	2 x 6	0.022	2.2	S1	32 g	18P	5500.2007	
3	Standard version	2 x 3	0.022	2.2	S1	32 g	18P	5500.2008	■
1	Standard version	2 x 30	0.047	2.2	S1	78 g	24P	5500.2009	
3	Standard version	2 x 4	0.047	2.2	S1	78 g	24P	5500.2010	
0.6	Medical Version (M5)	2 x 40	0.015	-	S2	35 g	13P	5500.2116	
1	Medical Version (M5)	2 x 10	0.015	-	S2	35 g	13P	5500.2117	
2	Medical Version (M5)	2 x 4	0.015	-	S2	25.5 g	13P	5500.2118	
4	Medical Version (M5)	2 x 1.5	0.015	-	S2	35 g	13P	5500.2119	
6	Medical Version (M5)	2 x 0.8	0.015	-	S2	35 g	13P	5500.2120	
0.7	Medical Version (M5)	2 x 40	0.015	-	S2	45 g	18P	5500.2121	
1	Medical Version (M5)	2 x 20	0.022	-	S2	45 g	18P	5500.2122	
2	Medical Version (M5)	2 x 6	0.022	-	S2	45 g	18P	5500.2123	
3	Medical Version (M5)	2 x 3	0.022	-	S2	45 g	18P	5500.2124	
1	Medical Version (M5)	2 x 30	0.047	-	S2	78 g	24P	5500.2125	
3	Medical Version (M5)	2 x 4	0.047	-	S2	78 g	24P	5500.2126	

■ Most Popular.

Availability for all products can be searched real-time: <https://www.schurter.com/en/Stock-Check/Stock-Check-SCHURTER>

Packaging unit

50 Pcs