

NHD-7.0-800480EF-ASXN#-T

TFT (Thin-Film-Transistor) Color Liquid Crystal Display Module

NHD-	Newhaven Display
7.0-	7.0" Diagonal
800480-	800x480 Pixels
EF-	Model
A-	Built-in Driver / No Controller
S-	Sunlight Readable
X-	TFT
N-	TN, Wide Temperature
#-	RoHS Compliant
T-	Resistive Touch Panel

Newhaven Display International, Inc.

2661 Galvin Ct.

Elgin IL, 60124

Ph: 847-844-8795

Fax: 847-844-8796

www.newhavendisplay.com

nhtech@newhavendisplay.com

nhsales@newhavendisplay.com

Document Revision History

Revision	Date	Description	Changed by
0	3/10/16	Initial Release	SB
1	7/5/16	Added Chromaticity, Updated Touch Panel Characteristics	SB
2	9/15/17	Backlight & Touch Panel Characteristics Updated	SB
3	3/9/20	LCD Driver Changed to EK9716	SB
4	5/22/20	Fixed Errors in Typical Backlight Voltage Value	AS
5	6/4/20	Updated Viewing Angles, Quality Information	AS
6	1/15/21	Updated 2D Mechanical Drawing	AS

Functions and Features

- 800x480 resolution
- LED backlight
- 24-bit digital RGB interface
- 16.7M colors
- Sunlight Readable
- 4-wire resistive Touch Panel

Mechanical Drawing

SYMBOL	REVISION	DATE

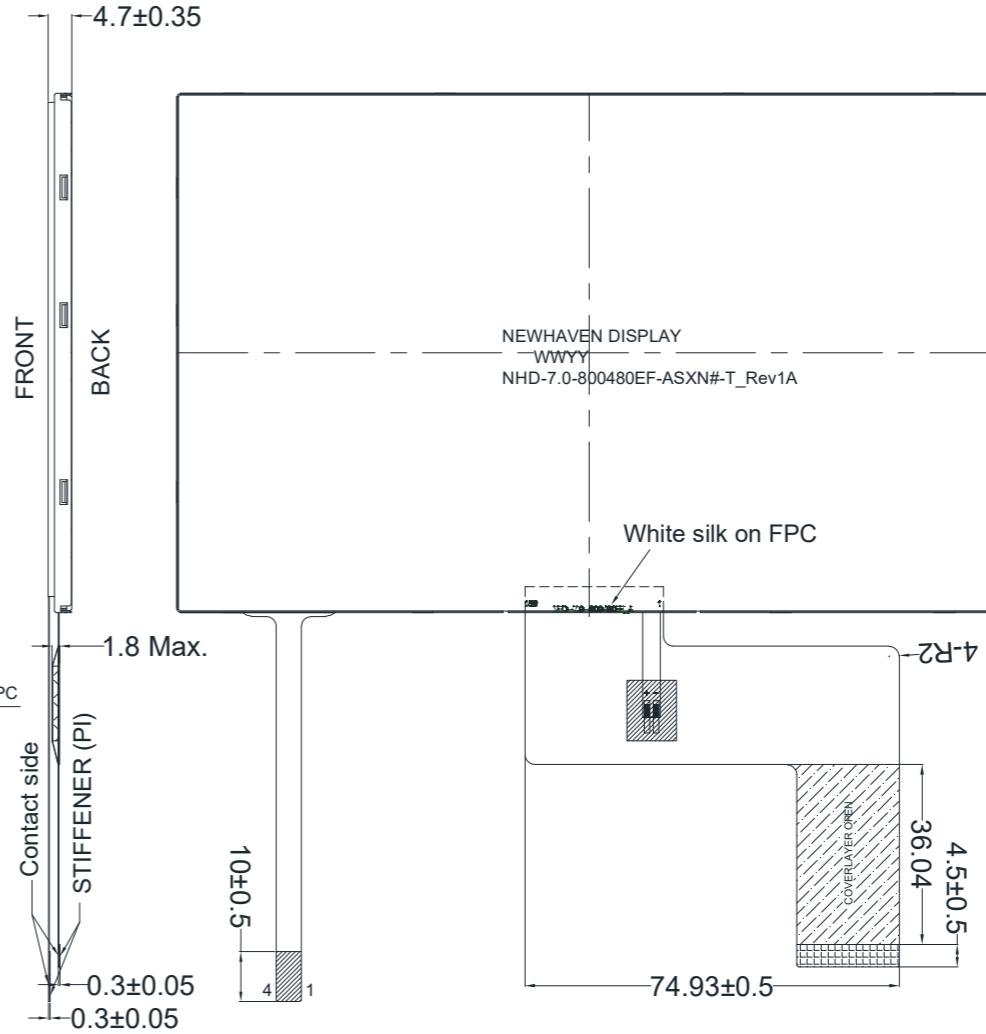
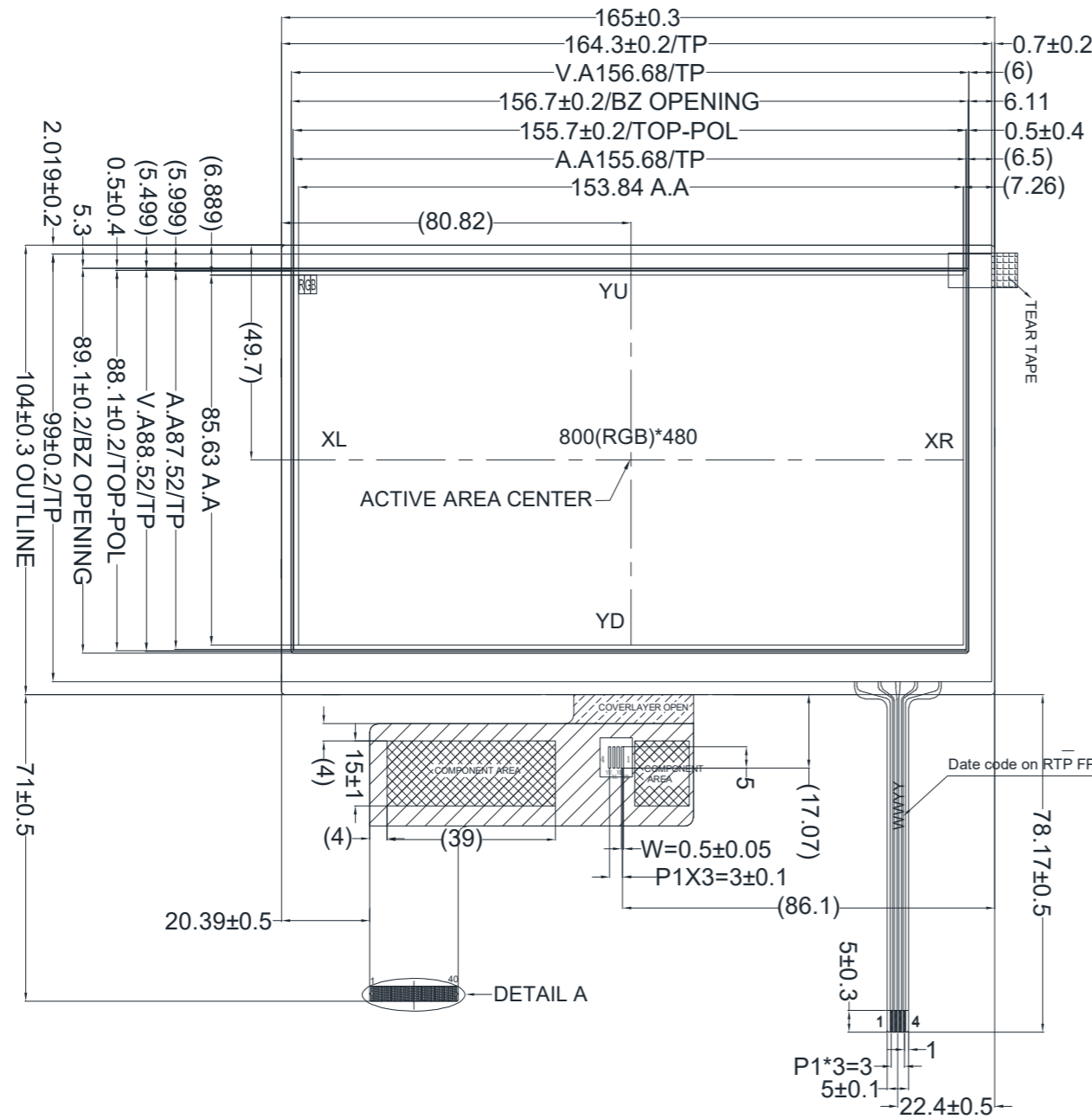

TFT Pinout:

Pin No.	Symbol
1	LEDK
2	LEDA
3	GND
4	VDD
5-12	[R0-R7]
13-20	[G0-G7]
21-28	[B0-B7]
29	GND
30	DCLK
31	DISP
32	HSYNC
33	VSYNC
34	DEN
35	NC
36	GND
37	XR
38	YD
39	XL
40	YU

Notes:

1. Display Size: 7.0" TFT
2. Optimal View: 12:00
3. Display Mode: Transmissive / Normally White / Anti-Glare
4. Driver IC: EK9716 & EK73002
5. Supply Voltage: 3.3V
6. Backlight: White LED / 9.3 V / 180 mA (Typ)
7. Brightness: 780cd/m² (Typ)
8. Touch Panel: 4-Wire Resistive
9. 3M Brightness Enhancement Film

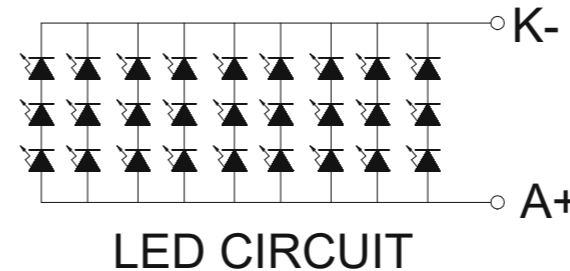
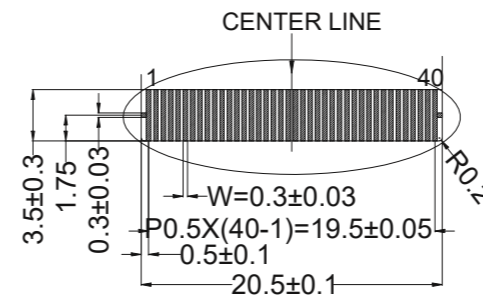

STANDARD TOLERANCE: (UNLESS OTHERWISE SPECIFIED)		
LINEAR: ±0.3mm	DRAWING/PART NUMBER: NHD-7.0-800480EF-ASXN#-T	REVISION: 1A
UNLESS OTHERWISE SPECIFIED: - DIMENSIONS ARE IN MILLIMETERS - THIRD ANGLE PROJECTION	DRAWN BY: A. Shah	APPROVED BY: A. Shah
	DRAWN DATE: 1/15/21	APPROVED DATE: 1/15/21
	DO NOT SCALE DRAWING	
	SHEET 1 OF 1	
THIS DRAWING IS SOLELY THE PROPERTY OF NEWHAVEN DISPLAY INTERNATIONAL, INC. THE INFORMATION IT CONTAINS IS NOT TO BE DISCLOSED, REPRODUCED OR COPIED IN WHOLE OR PART WITHOUT WRITTEN APPROVAL FROM NEWHAVEN DISPLAY.		

Pin Description

TFT:

Pin No.	Symbol	External Connection	Function Description
1	LED_K	Power Supply	Backlight Cathode (Ground)
2	LED_A	Power Supply	Backlight Anode (180mA @ 9.3V)
3	GND	Power Supply	Ground
4	V _{DD}	Power Supply	Supply Voltage for LCD and logic (3.3V)
5-12	[R0-R7]	MPU	Red Data signals
13-20	[G0-G7]	MPU	Green Data signals
21-28	[B0-B7]	MPU	Blue Data signals
29	GND	Power Supply	Ground
30	DCLK	MPU	Dot Data Clock (Falling Edge Triggered)
31	DISP	MPU	Display on/off DISP=1:Display ON
32	HSYNC	MPU	Line synchronization signal
33	VSYNC	MPU	Frame synchronization signal
34	DEN	MPU	Data Enable signal
35	NC	-	No Connect
36	GND	Power Supply	Ground
37	NC(XR)	-	No Connect
38	NC(YD)	-	No Connect
39	NC(XL)	-	No Connect
40	NC(YU)	-	No Connect

Recommended connector: 0.5mm pitch 40-Conductor FFC. Molex p/n: 54104-4031 (top contact)

Resistive Touch Panel:

Pin No.	Symbol	External Connection	Function Description
1	XL	Touch Controller	Touch Panel – Left
2	YD	Touch Controller	Touch Panel – Down
3	XR	Touch Controller	Touch Panel – Right
4	YU	Touch Controller	Touch Panel – Up

Recommended connector: 1.0mm pitch 4-Conductor FFC. Molex p/n: 52207-0485 (top contact)

Driver Information

Built-in HX8264-D02 Source Driver: http://www.newhavendisplay.com/app_notes/HX8264-D02.pdf

Built-in HX8664-B Gate Driver: http://www.newhavendisplay.com/app_notes/HX8664-B.pdf

Electrical Characteristics

Item	Symbol	Condition	Min.	Typ.	Max.	Unit
Operating Temperature Range	T _{OP}	Absolute Max	-20	-	+70	°C
Storage Temperature Range	T _{ST}	Absolute Max	-30	-	+80	°C
Supply Voltage	V _{DD}	-	3.0	3.3	3.6	V
Supply Current	I _{DD}	V _{DD} = 3.3V, 25°C	45	90	135	mA
"H" Level Input	V _{IH}	-	0.7*V _{DD}	-	V _{DD}	V
"L" Level Input	V _{IL}	-	V _{SS}	-	0.3*V _{DD}	V
"H" Level Output	V _{OH}	-	V _{DD} -0.4	-	-	V
"L" Level Output	V _{OL}	-	V _{SS}	-	V _{SS} +0.4	V
Backlight Supply Current	I _{LED}	-	-	180	225	mA
Backlight Supply Voltage	V _{LED}	I _{LED} = 180 mA	8.4	9.3	10.2	V
Backlight Lifetime*	-	T _{OP} = 25° C	20,000	50,000	-	Hrs.

*Backlight lifetime is rated as Hours until **half-brightness**, under normal operating conditions. The LED of the backlight is driven by current drain; drive voltage is for reference only. Drive voltage must be selected to ensure backlight current drain is below MAX level stated.

Optical Characteristics

Item	Symbol	Condition	Min.	Typ.	Max.	Unit	
Optimal Viewing Angles	Top	φY+	CR ≥ 10	-	60	-	°
	Bottom	φY-		-	70	-	°
	Left	θX-		-	70	-	°
	Right	θX+		-	70	-	°
Contrast Ratio	CR	-	-	500	-	-	
Luminance	L _V	I _{LED} = 180 mA	620	780	-	cd/m ²	
Response Time	T _R + T _F	T _{OP} = 25°C	-	25	-	ms	
Chromaticity	Red	X _R	-	0.532	0.582	0.632	-
		Y _R	-	0.292	0.342	0.392	-
	Green	X _G	-	0.285	0.335	0.385	-
		Y _G	-	0.574	0.624	0.674	-
	Blue	X _B	-	0.104	0.154	0.204	-
		Y _B	-	0.092	0.142	0.192	-
White	X _W	-	0.257	0.307	0.357	-	
	Y _W	-	0.334	0.384	0.434	-	

Touch Panel Characteristics

Item	Min.	Typ.	Max.	Unit
Linearity	-3	-	3	%
Terminal Resistance – X-Axis	350	-	1100	Ω
Terminal Resistance – Y-Axis	50	-	400	Ω
Insulation Resistance	20	-	-	MΩ
Operating Voltage	-	-	5	V
Chattering	-	-	15	ms
Activation Force	30	-	100	g
Pen Writing Durability	50,000	-	-	Characters
Pitting Durability	1,000,000	-	-	Touches
Surface Hardness	3	-	-	H

Timing Characteristics

Parallel RGB Input Timing Requirements

Item	Symbol	Min.	Typ.	Max.	Unit	Remark	
DCLK Frequency	F_{clk}	28.2	29.2	40	MHz	-	
DLCK Period	T_{clk}	25	34	-	ns	-	
HSYNC	Period Time	T_h	908	928	1088	DCLK	Thw + Thbp = 88 DCLK is fixed
	Display Period	T_{ndisp}	800			DCLK	
	Pulse Width	T_{hw}	1	48	87	DCLK	
	Back Porch	T_{hbp}	87	40	1	DCLK	
	Front Porch	T_{hfp}	20	40	200	DCLK	
VSYNC	Display Period	T_{vdisp}	480			H	Tv + Tvbp = 32 H is fixed
	Period Time	T_v	517	525	613	H	
	Pulse Width	T_{vw}	1	1	3	H	
	Back Porch	T_{vbp}	31	31	29	H	
	Front Porch	T_{vfp}	5	13	101	H	

DE Mode Timing Diagram

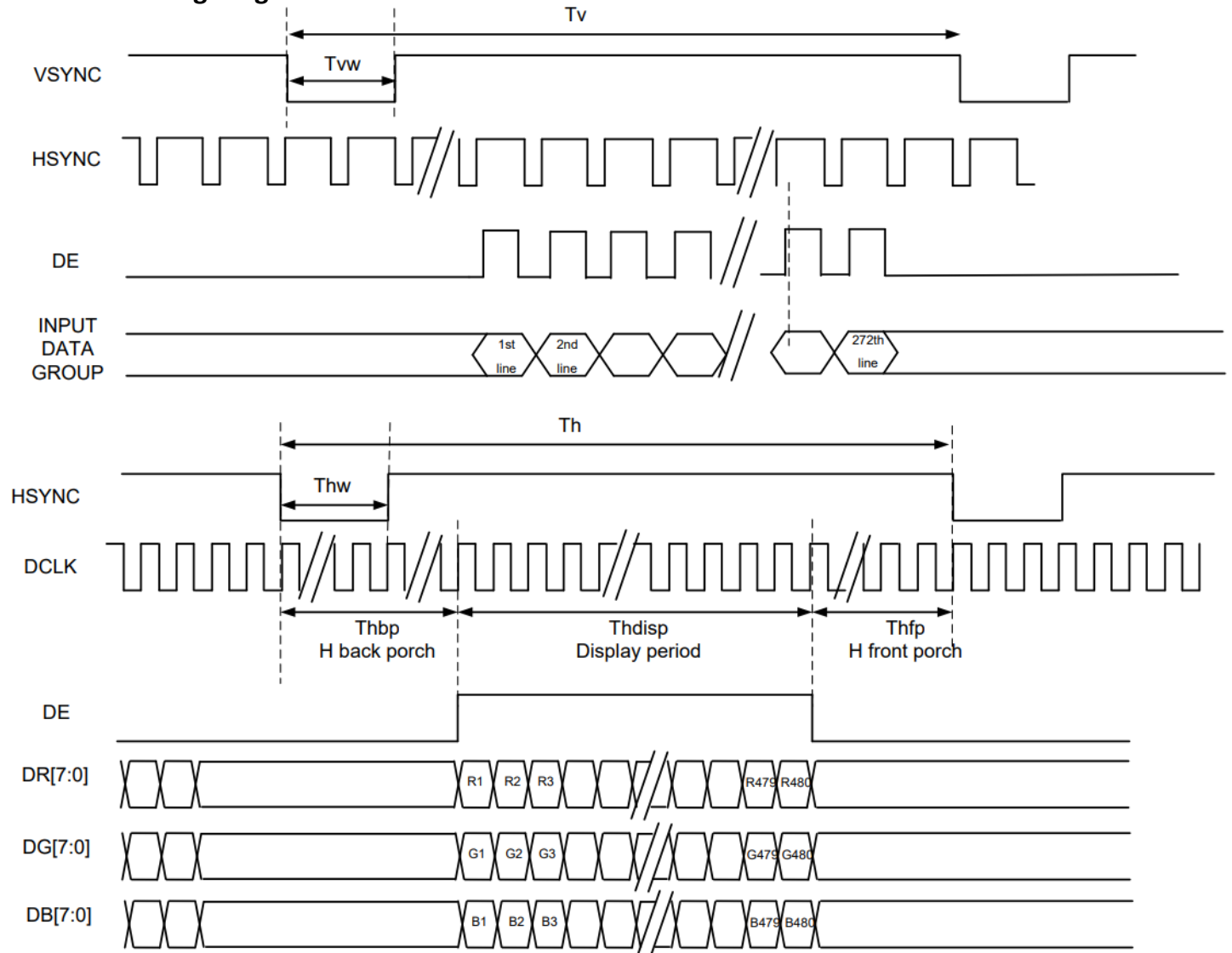

Input Setup Timing Requirements

Item	Symbol	Min.	Typ.	Max.	Unit	Conditions
V _{DD} Power Source Slew Time	T _{por}	-	-	20	ms	From 0V to 90% V _{DD}
CLK cycle time	T _{cph}	20	-	-	ns	-
CLK pulse duty	T _{cwh}	40	50	60	%	-
Data setup time	T _{dsu}	8	-	-	ns	-
Data hold time	T _{dhd}	8	-	-	ns	-
DEN setup time	T _{esu}	8	-	-	ns	-
DEN hold time	T _{ehd}	8	-	-	ns	-

Input Setup Timing Diagram

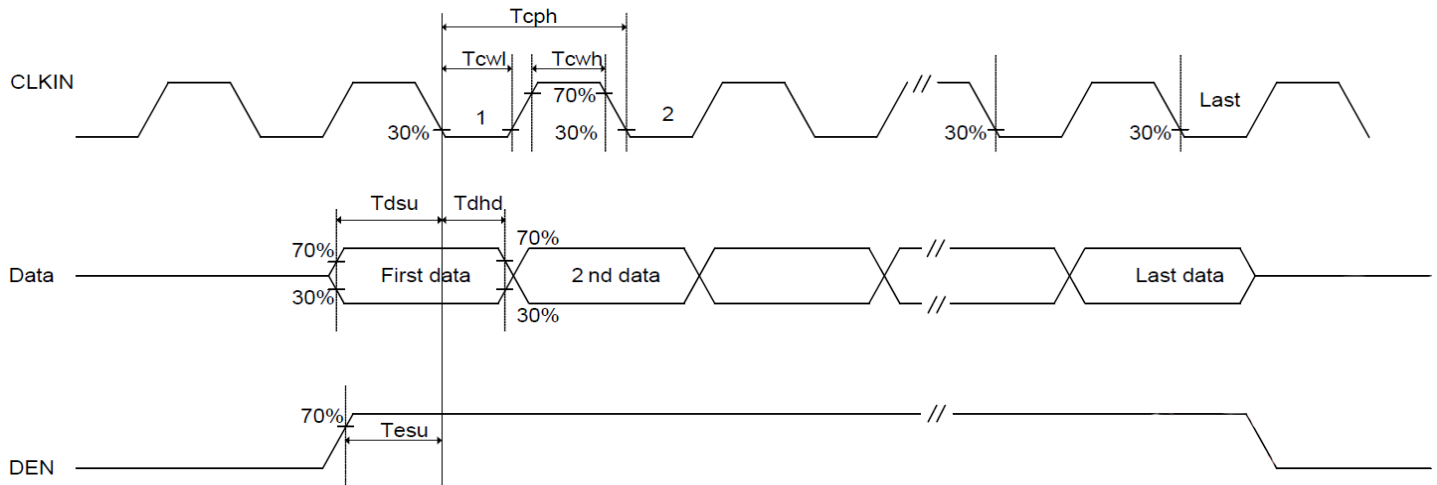

Power ON/OFF Sequence

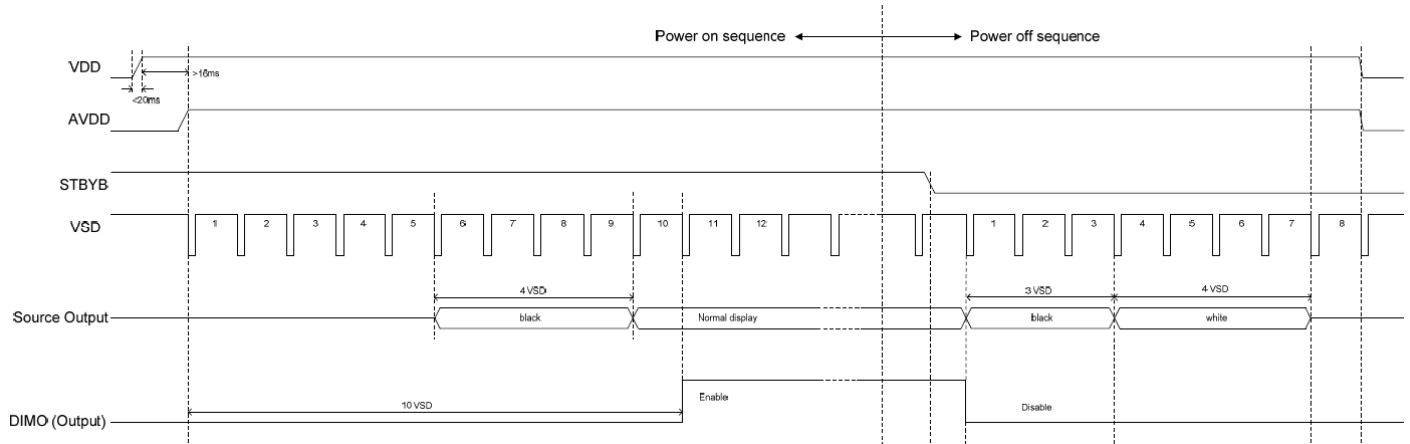

Enter/Exit Standby Mode Sequence

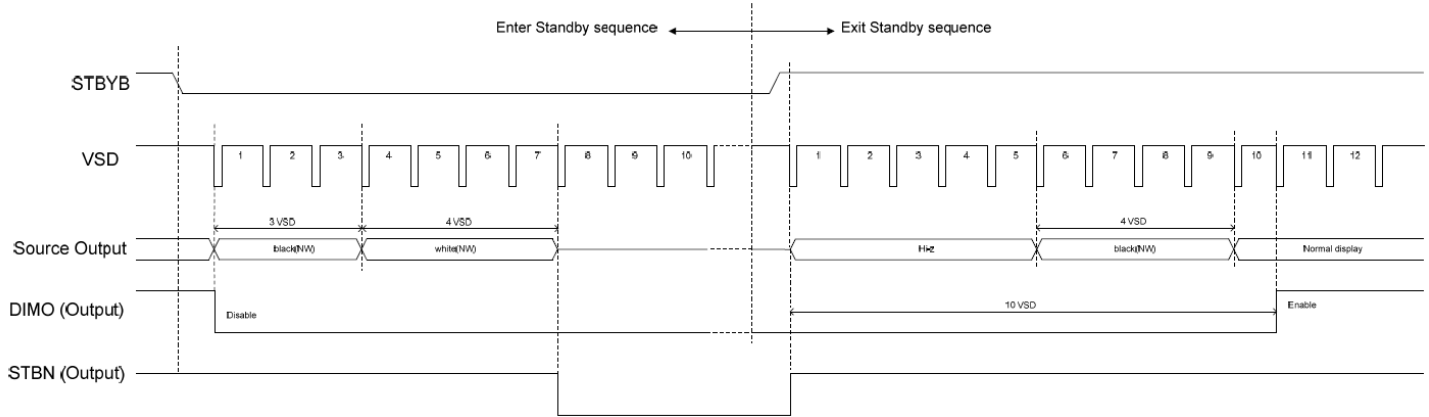

Quality Information

Test Item	Content of Test	Test Condition	Note
High Temperature storage	Endurance test applying the high storage temperature for a long time.	+80°C, 96hrs	2
Low Temperature storage	Endurance test applying the low storage temperature for a long time.	-30°C, 96hrs	1,2
High Temperature Operation	Endurance test applying the electric stress (voltage & current) and the high thermal stress for a long time.	+70°C, 96hrs	2
Low Temperature Operation	Endurance test applying the electric stress (voltage & current) and the low thermal stress for a long time.	-20°C, 96hrs	1,2
High Temperature / Humidity Storage	Endurance test applying the electric stress (voltage & current) and the high thermal with high humidity stress for a long time.	+50°C, 90% RH, 96hrs	1,2
Thermal Shock resistance	Endurance test applying the electric stress (voltage & current) during a cycle of low and high thermal stress.	-20°C, 60min -> 70°C, 60min, = 1 Cycle For 20 cycles	
Vibration test	Endurance test applying vibration to simulate transportation and use.	10-50Hz , 5G Acceleration 60 sec in each of 3 directions (X,Y,Z) For 30 minutes	3
Static electricity test	Endurance test applying electric static discharge.	Air: ±8KV 150pf/330Ω 5 Times	
		Contact: ±4KV 150pf/330Ω 5 times	

Note 1: No condensation to be observed.

Note 2: Conducted after 4 hours of storage at 25°C, 0%RH.

Note 3: Test performed on product itself, not inside a container.

Precautions for using LCDs/LCMs

See Precautions at www.newhavendisply.com/specs/precautions.pdf

Warranty Information and Terms & Conditions

http://www.newhavendisply.com/index.php?main_page=terms