

ANT-8/9-MMG1-SMA Series Magnetic Mount 868/915 MHz LPWA Antennas

The ANT-8/9-MMG1-SMA antenna is an external magnetic mount multiband antenna designed for use in 868 MHz and 915 MHz bands for low-power wide-area (LPWA) applications such as LoRaWAN®, Sigfox® and WiFi HaLow™ as well as ISM and remote control applications.

The ANT-8/9-MMG1-SMA series antennas provide a ground plane independent dipole antenna solution which mounts to ferrous metallic surfaces using the integrated magnetic base.

The antenna terminates in an SMA plug (male pin) connector on a 1 meter, 2 meter or 3 meter length of RG-174/U coaxial cable.



Features

- Performance at 862 MHz to 876 MHz
 - VSWR: ≤ 2.0
 - Peak Gain: 2.0 dBi
 - Efficiency: 66%
- Performance at 902 MHz to 930 MHz
 - VSWR: ≤ 2.1
 - Peak Gain: 2.3 dBi
 - Efficiency: 69%
- Ground plane independent dipole antenna
- Compact, only 82.8 mm (3.26 in) tall
- Integrated magnetic base securely attaches to ferrous metallic surfaces and allows for repositioning
- SMA plug (male pin) connection

Applications

- Low-power, wide-area (LPWA) applications
 - LoRaWAN®, ITU-T Y.4480
 - Sigfox®
 - WiFi HaLow™ (802.11ah)
- Remote control, monitoring and sensing
- Internet of Things (IoT) devices
- ISM applications

Ordering Information

Part Number	Description
ANT-8/9-MMG1-SMA-1	Magnetic mount 868/915 MHz antenna with an SMA plug (male pin) connector on 1 m (39.37 in) RG-174/U coaxial cable
ANT-8/9-MMG1-SMA-2	Magnetic mount 868/915 MHz antenna with an SMA plug (male pin) connector on 2 m (78.74 in) RG-174/U coaxial cable
ANT-8/9-MMG1-SMA-3	Magnetic mount 868/915 MHz antenna with an SMA plug (male pin) connector on 3 m (118.11 in) RG-174/U coaxial cable

Available from Linx Technologies and select distributors and representatives.

Table 1. Electrical Specifications

ANT-8/9-MMG1-SMA	868 MHz	915 MHz
Frequency Range	862 MHz to 876 MHz	902 MHz to 930 MHz
VSWR (max.)	2.0	2.1
Peak Gain (dBi)	2.0	2.3
Average Gain (dBi)	-1.9	-1.7
Efficiency (%)	66	69
Polarization	Linear	
Radiation	Omnidirectional	
Max Power	10 W	
Wavelength	1/2-wave	
Electrical Type	Dipole	
Impedance	50 Ω	

Electrical specifications and plots measured on a 300 mm x 300 mm (11.8 in x 11.8 in) ground plane.

Table 2. Mechanical Specifications

Part Number	Connection	Coaxial Cable, minimum inside bend radius	Weight
ANT-8/9-MMG1-SMA-1	SMA plug (male pin)	RG-174/U: 10.2 mm (0.40 in),	1 meter = 30.1 g (1.06 oz)
ANT-8/9-MMG1-SMA-2	SMA plug (male pin)	RG-174/U: 10.2 mm (0.40 in),	2 meters = 43.4 g (1.53 oz)
ANT-8/9-MMG1-SMA-3	SMA plug (male pin)	RG-174/U: 10.2 mm (0.40 in),	3 meters = 56.8 g (2.00 oz)
Operating Temp. Range	-20 °C to +80 °C		
Storage Temp. Range	-20 °C to +80 °C		
Dimensions	82.8 mm x Ø30.0 mm (3.26 in x Ø1.18 in)		

Product Dimensions

Figure 1 provides dimensions of the ANT-8/9-MMG1-SMA series antenna.

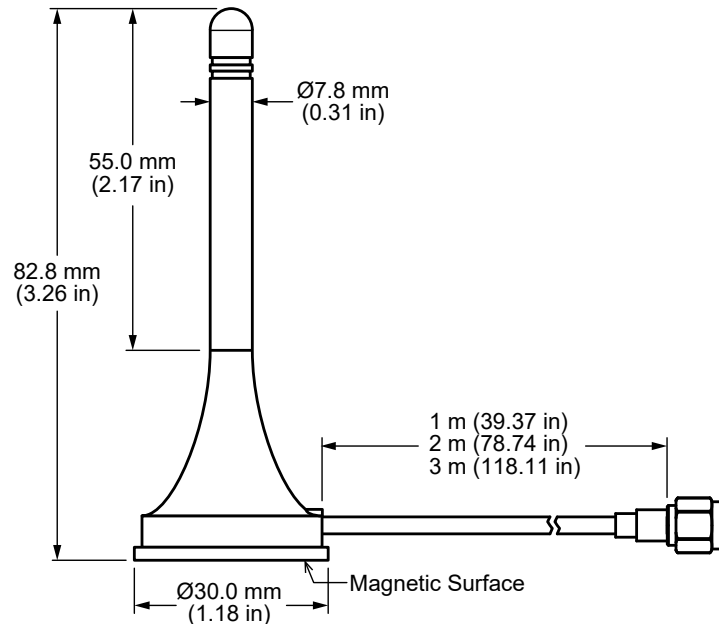

Figure 1. ANT-8/9-MMG1-SMA Series Antenna Dimensions

Antenna Mounting

The ANT-8/9-MMG1-SMA series antenna has an integrated magnetic base which mounts securely to ferrous metallic surfaces. The antenna should be mounted in a location that is not obstructed by other metallic surfaces which could interfere with signal transmission and reception. The magnetic base allows for the antenna to be repositioned as needed.

Packaging Information

The ANT-8/9-MMG1-SMA series antenna is individually sealed in a polyethylene bag 3.9 in x 7.1 in (100 mm x 180 mm) and packaged in larger bags in of 50 pcs 14.2 in x 20.5 in (360 mm x 520 mm). Bags are packed in cartons in quantities of 400 pcs. Distribution channels may offer alternative packaging options.

LPWA: LoRaWAN® and Sigfox®

LoRaWAN and Sigfox LPWA technologies operate within several of the frequencies supported by the ANT-8/9-MMG1-SMA antenna. Notably, LoRaWAN operates at the frequency bands shown in Table 3. Sigfox operates at different frequencies determined by country (Table 4).

Table 3. LoRaWAN® Channel plan

Frequency Band	LoRaWAN Channel Plan
779 MHz to 787 MHz	CN779-787
865 MHz to 867 MHz	IN765-867
868 MHz to 873 MHz	EU863-870
902 MHz to 928 MHz	US902-928, AS923
915 MHz to 928 MHz	AU915-928
917 MHz to 923.5 MHz	KR920-923

Table 4. Sigfox® Frequencies by Country/Region

Center Frequency	Select Countries/Regions
868 MHz	Europe
902 MHz	USA, Mexico, Brazil
920 MHz	Australia
923 MHz	Japan

Antenna Orientation

The ANT-8/9-MMG1-SMA antenna is characterized in two antenna orientations as shown in Figure 2. The antenna free space orientation characterizes use of an antenna attached to an enclosure-mounted connector which is connected by cable to a printed circuit board. Although the antenna is a dipole not requiring a ground plane for function, characterization on an adjacent ground plane (300 mm x 300 mm) provides insight into antenna performance when attached directly to a connector on a metal enclosure. The two orientations represent the most common end-product use cases.



Figure 2. ANT-5GW-MMG1-SMA Test Orientations

On Ground Plane

The charts on the following pages represent data taken with the antenna oriented at the center of the 300 mm x 300 mm ground plane as shown in Figure 3.

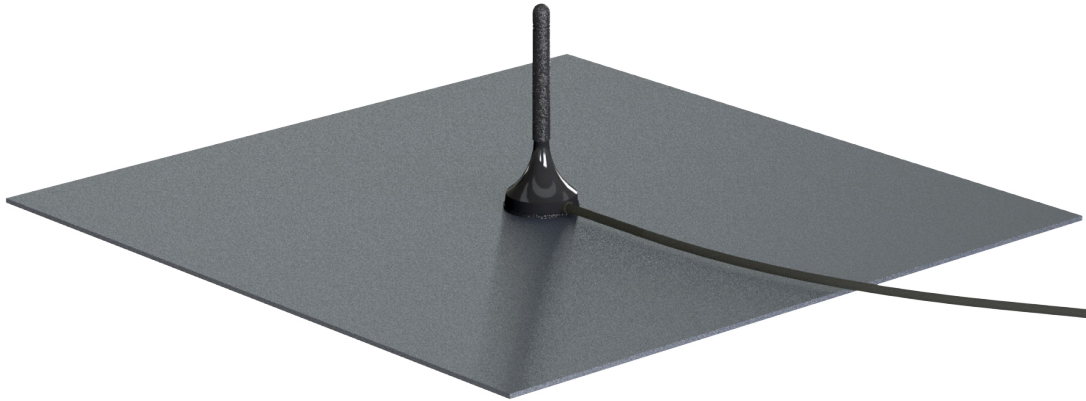

Figure 3. ANT-8/9-MMG1-SMA on Ground Plane

VSWR

Figure 4 provides the voltage standing wave ratio (VSWR) across the antenna bandwidth. VSWR describes the power reflected from the antenna back to the radio. A lower VSWR value indicates better antenna performance at a given frequency. Reflected power is also shown on the right-side vertical axis as a gauge of the percentage of transmitter power reflected back from the antenna.

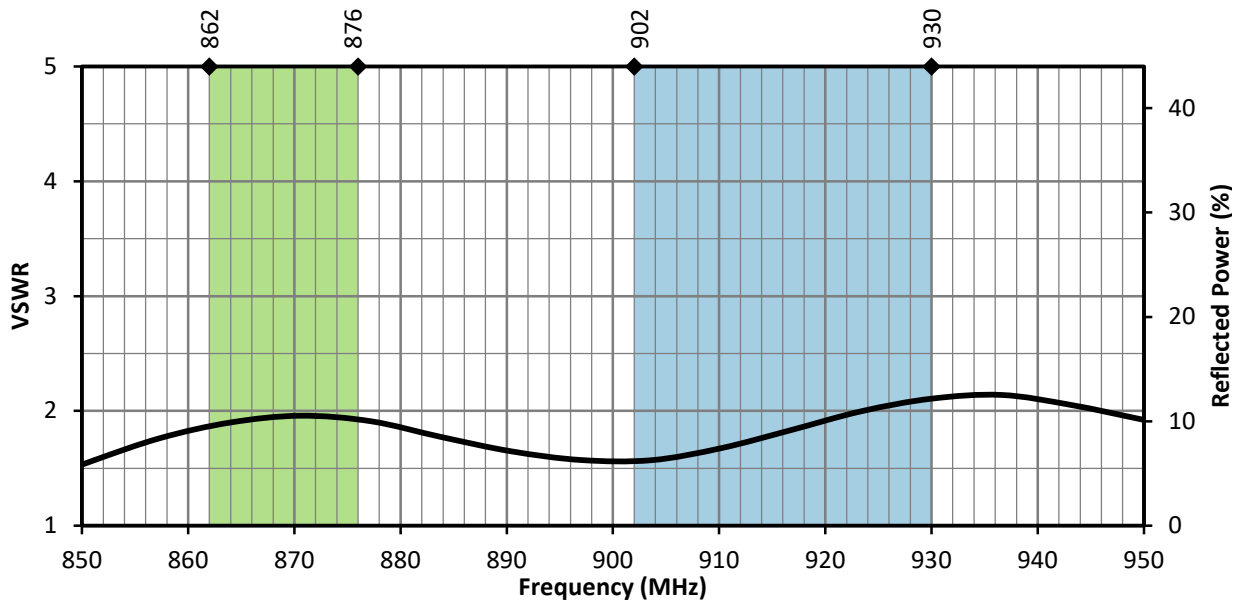

Figure 4. ANT-8/9-MMG1-SMA Antenna VSWR on Ground Plane

Return Loss

Return loss (Figure 5), represents the loss in power at the antenna due to reflected signals. Like VSWR, a lower return loss value indicates better antenna performance at a given frequency.

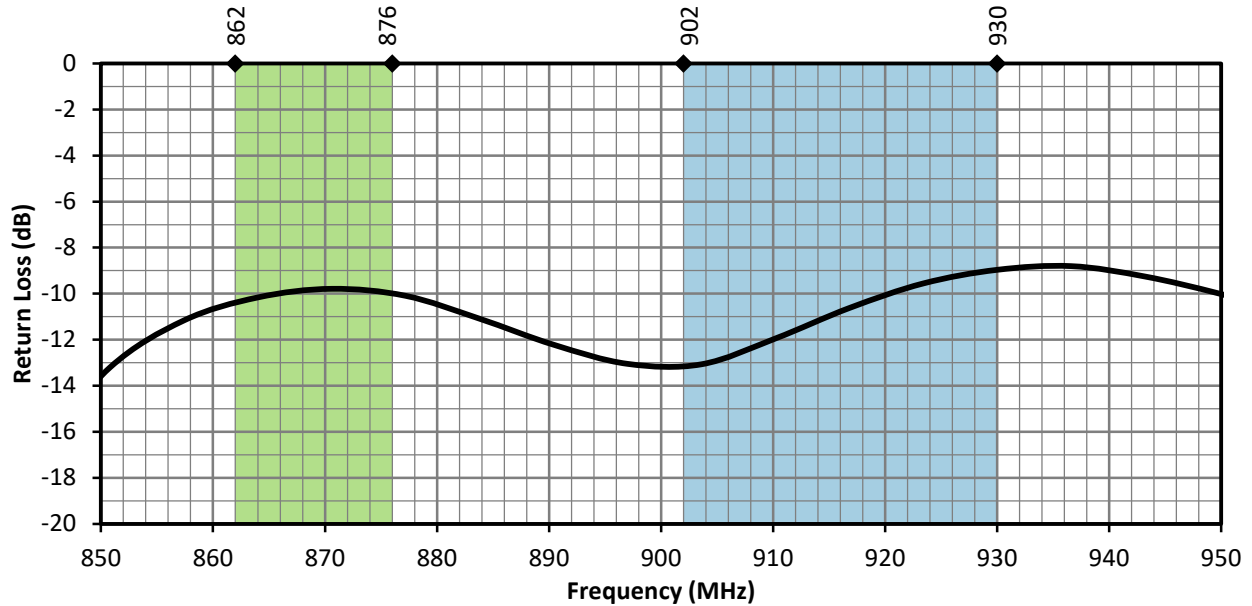

Figure 5. ANT-8/9-MMG1-SMA Antenna Return Loss on Ground Plane

Peak Gain

The peak gain across the antenna bandwidth is shown in Figure 6. Peak gain represents the maximum antenna input power concentration across 3-dimensional space, and therefore peak performance, at a given frequency, but does not consider any directionality in the gain pattern.

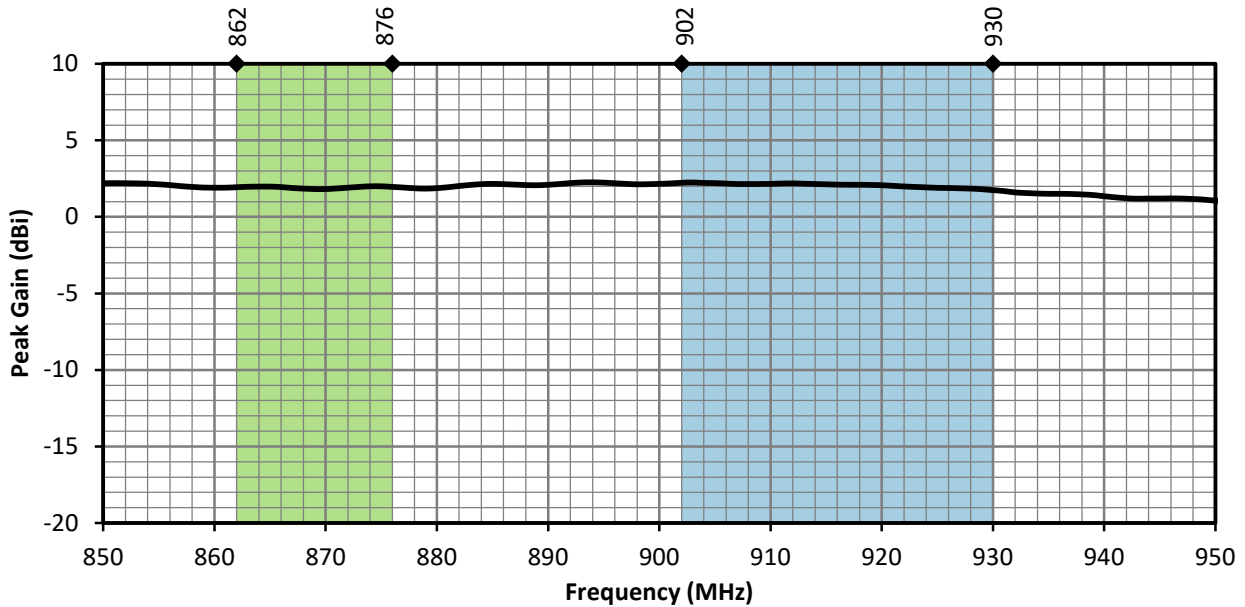

Figure 6. ANT-8/9-MMG1-SMA Antenna Peak Gain on Ground Plane

Average Gain

Average gain (Figure 7), is the average of all antenna gain in 3-dimensional space at each frequency, providing an indication of overall performance without expressing antenna directionality.

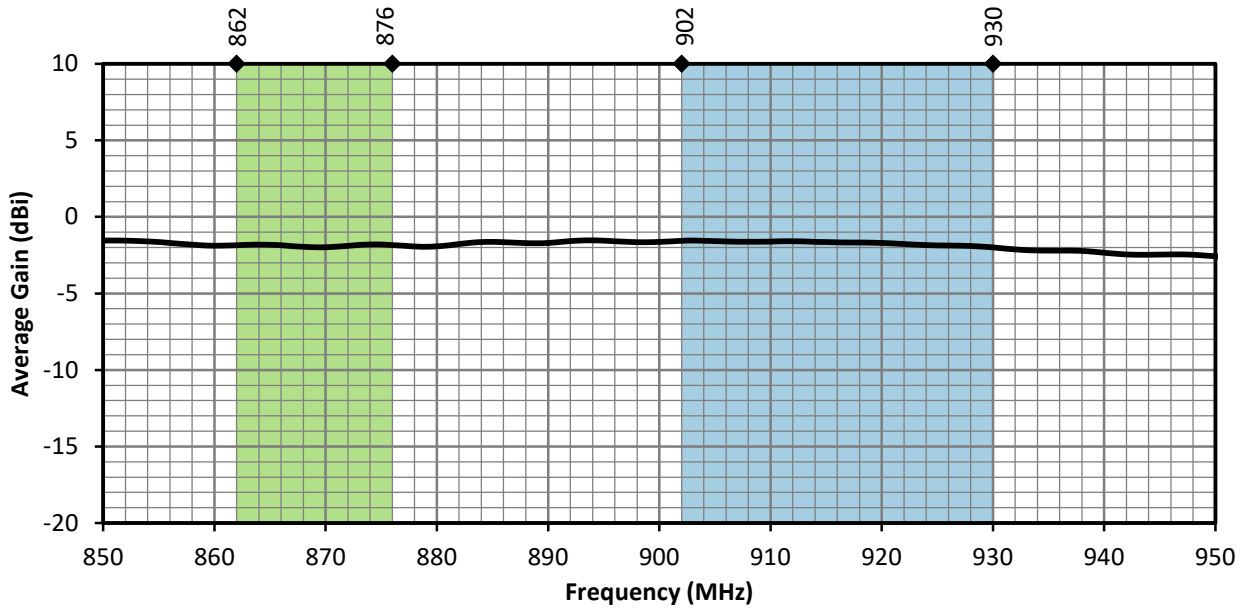

Figure 7. ANT-8/9-MMG1-SMA Antenna Average Gain on Ground Plane

Radiation Efficiency

Radiation efficiency (Figure 8), shows the ratio of power delivered to the antenna relative to the power radiated at the antenna, expressed as a percentage, where a higher percentage indicates better performance at a given frequency.

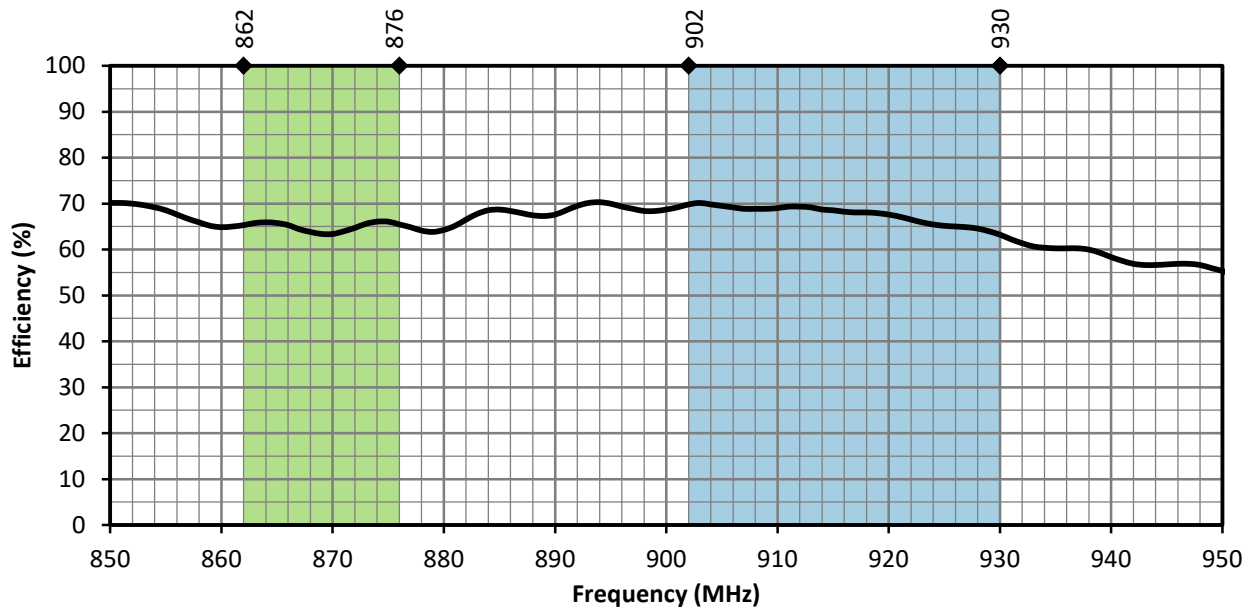

Figure 8. ANT-8/9-MMG1-SMA Antenna Radiation Efficiency on Ground Plane

Radiation Patterns

Radiation patterns provide information about the directionality and 3-dimensional gain performance of the antenna by plotting gain at specific frequencies in three orthogonal planes. Antenna radiation patterns (Figure 9), are shown using polar plots covering 360 degrees. The antenna graphic above the plots provides reference to the plane of the column of plots below it. Note: when viewed with typical PDF viewing software, zooming into radiation patterns is possible to reveal fine detail.

Radiation Patterns - On Ground Plane



862 MHz to 876 MHz (868 MHz)

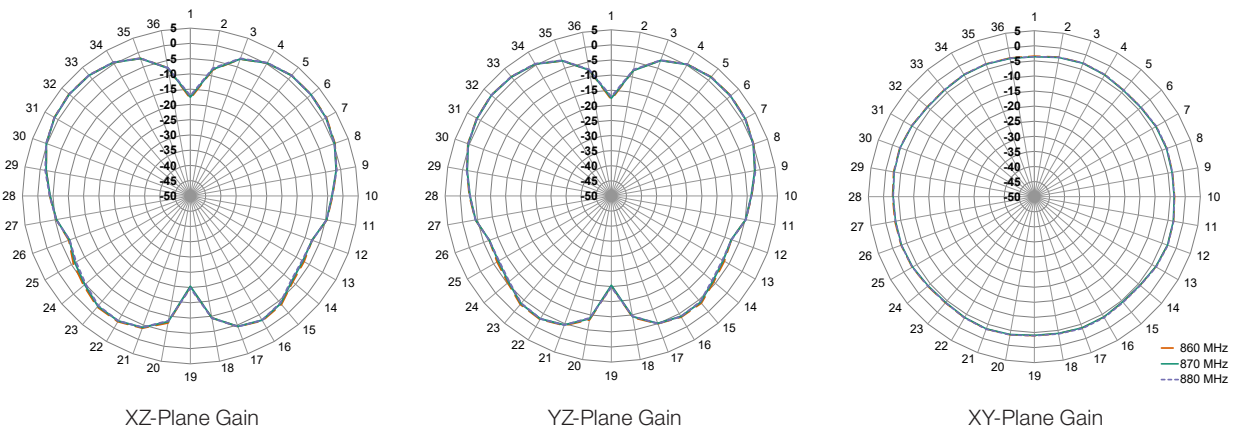

902 MHz to 930 MHz (915 MHz)

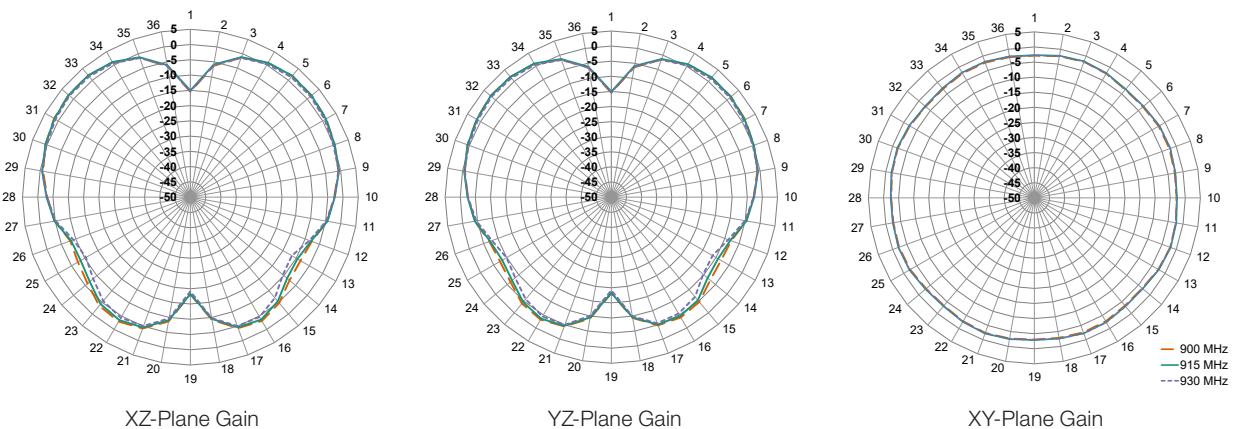

Figure 9. Radiation Patterns for ANT-8/9-MMG1-SMA Antenna on Ground Plane

Free Space, No Ground Plane

The charts on the following pages represent data taken with the antenna oriented in free space as shown in Figure 10.



Figure 10. ANT-5GW-MMG1-SMA No Ground Plane (Free Space)

VSWR

Figure 11 provides the voltage standing wave ratio (VSWR) across the antenna bandwidth. VSWR describes the power reflected from the antenna back to the radio. A lower VSWR value indicates better antenna performance at a given frequency. Reflected power is also shown on the right-side vertical axis as a gauge of the percentage of transmitter power reflected back from the antenna.

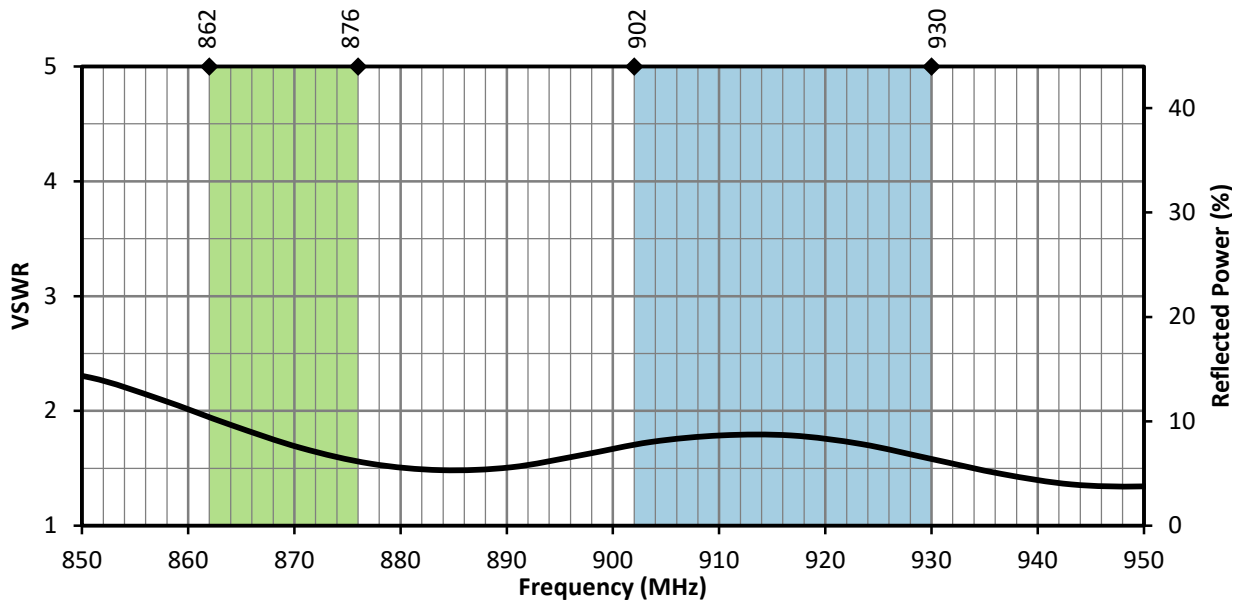

Figure 11. ANT-8/9-MMG1-SMA Antenna VSWR, Free Space

Return Loss

Return loss (Figure 12), represents the loss in power at the antenna due to reflected signals. Like VSWR, a lower return loss value indicates better antenna performance at a given frequency.

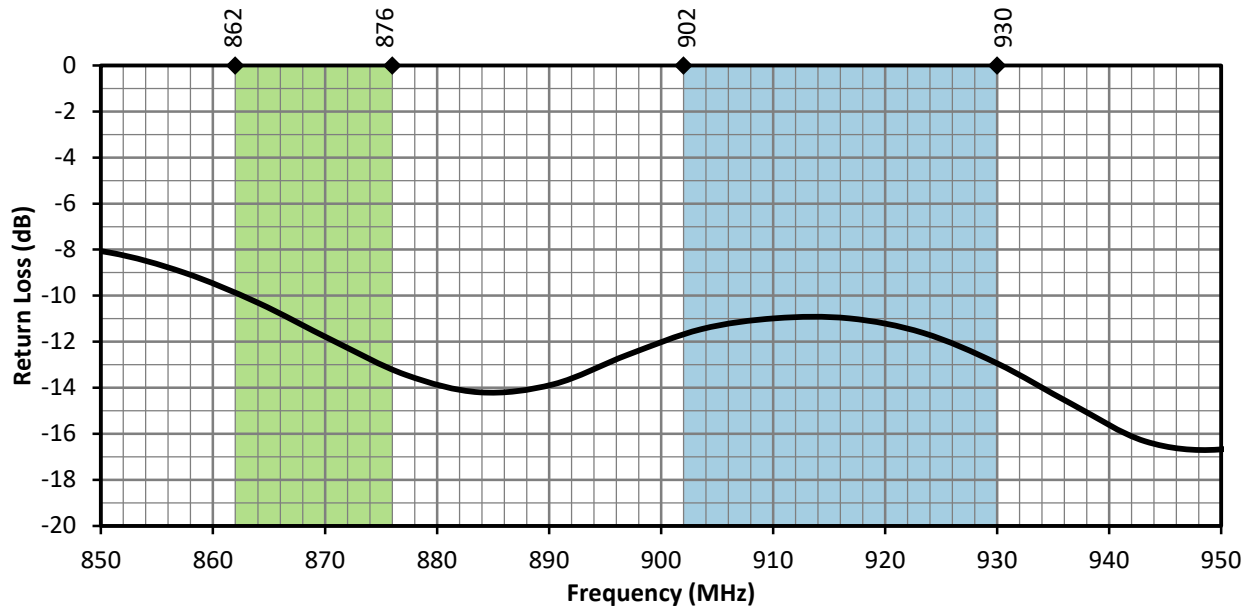

Figure 12. ANT-8/9-MMG1-SMA Antenna Return Loss, Free Space

Peak Gain

The peak gain across the antenna bandwidth is shown in Figure 13. Peak gain represents the maximum antenna input power concentration across 3-dimensional space, and therefore peak performance, at a given frequency, but does not consider any directionality in the gain pattern.

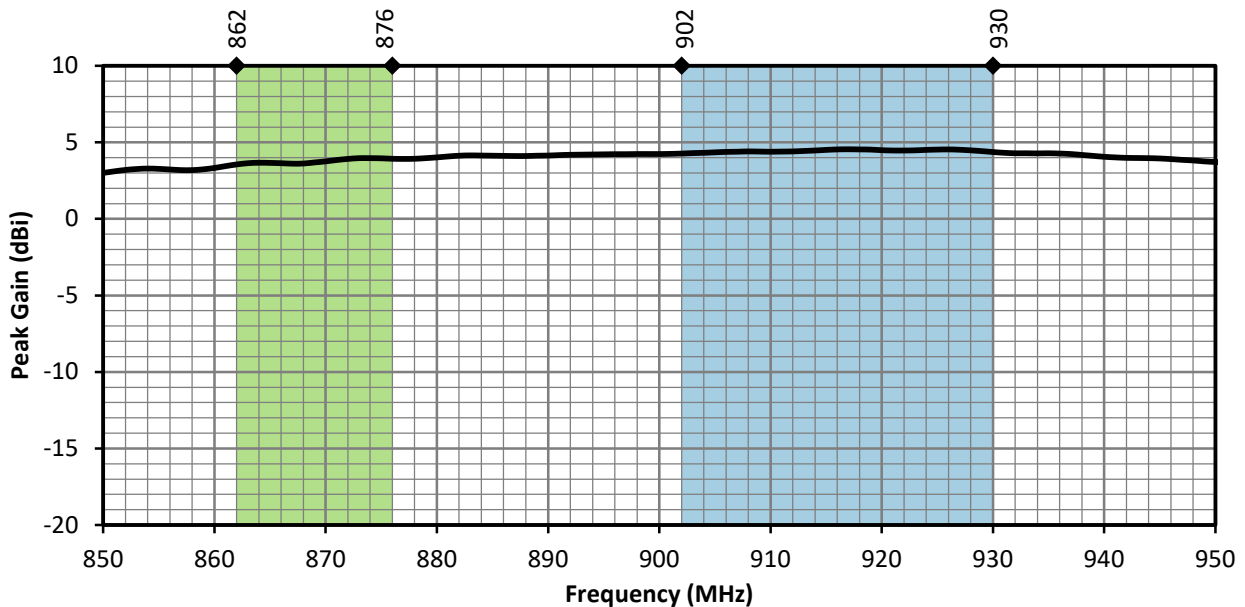

Figure 13. ANT-8/9-MMG1-SMA Antenna Peak Gain, Free Space

Average Gain

Average gain (Figure 14), is the average of all antenna gain in 3-dimensional space at each frequency, providing an indication of overall performance without expressing antenna directionality.

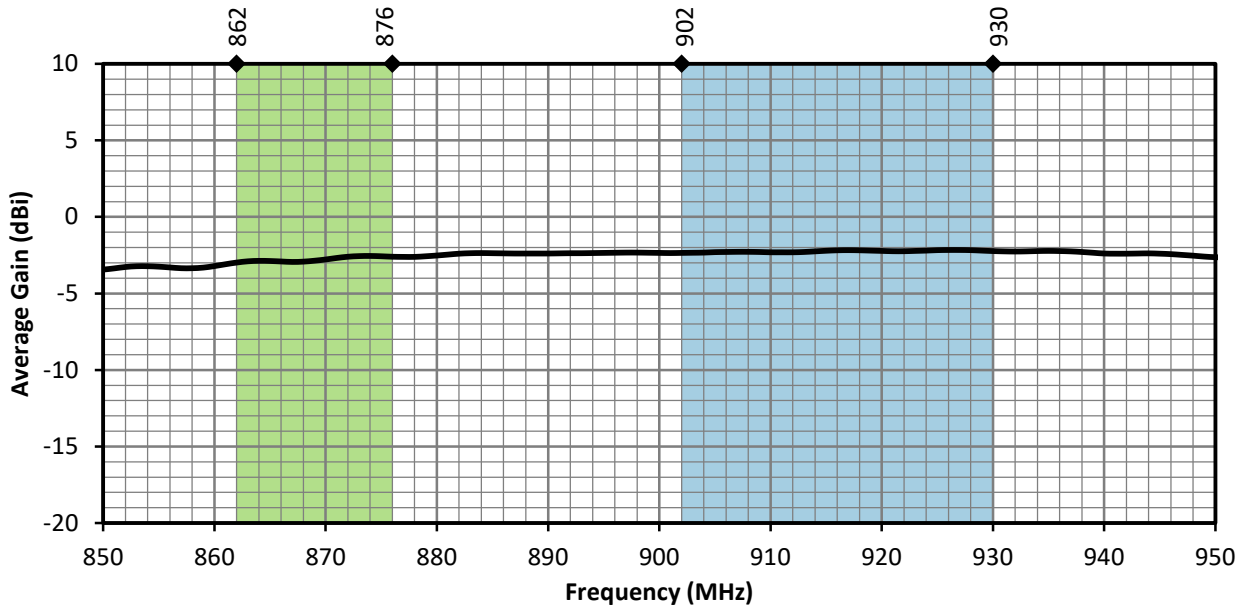

Figure 14. ANT-8/9-MMG1-SMA Antenna Average Gain, Free Space

Radiation Efficiency

Radiation efficiency (Figure 15), shows the ratio of power delivered to the antenna relative to the power radiated at the antenna, expressed as a percentage, where a higher percentage indicates better performance at a given frequency.

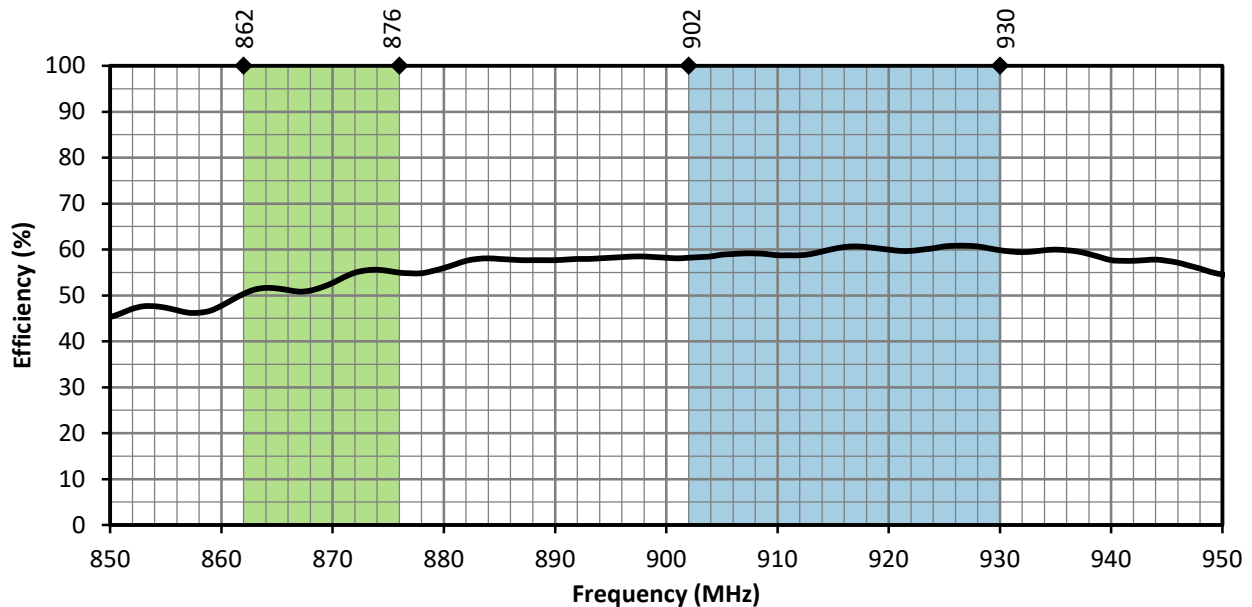

Figure 15. ANT-8/9-MMG1-SMA Antenna Radiation Efficiency, Free Space

Radiation Patterns

Radiation patterns provide information about the directionality and 3-dimensional gain performance of the antenna by plotting gain at specific frequencies in three orthogonal planes. Antenna radiation patterns (Figure 16), are shown using polar plots covering 360 degrees. The antenna graphic above the plots provides reference to the plane of the column of plots below it. Note: when viewed with typical PDF viewing software, zooming into radiation patterns is possible to reveal fine detail.

Radiation Patterns - Free Space



862 MHz to 876 MHz (868 MHz)

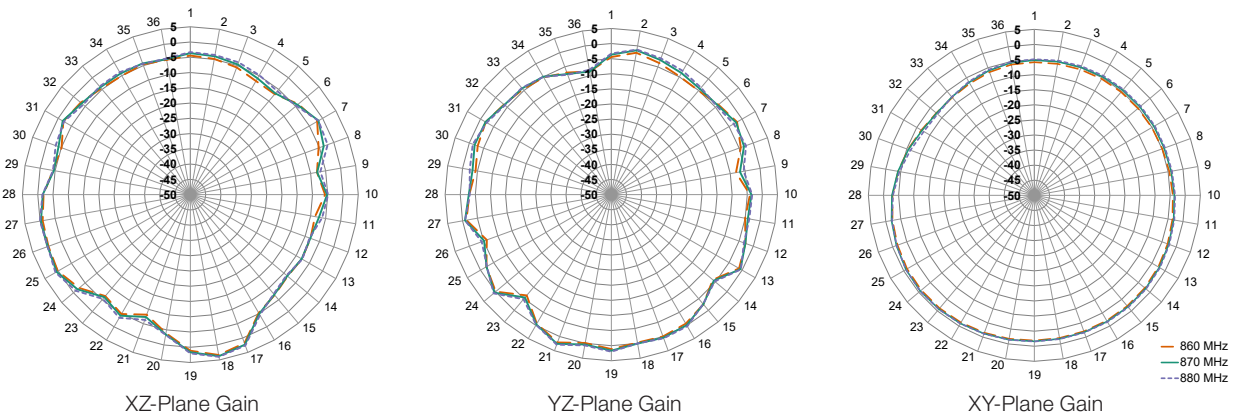

902 MHz to 930 MHz (915 MHz)

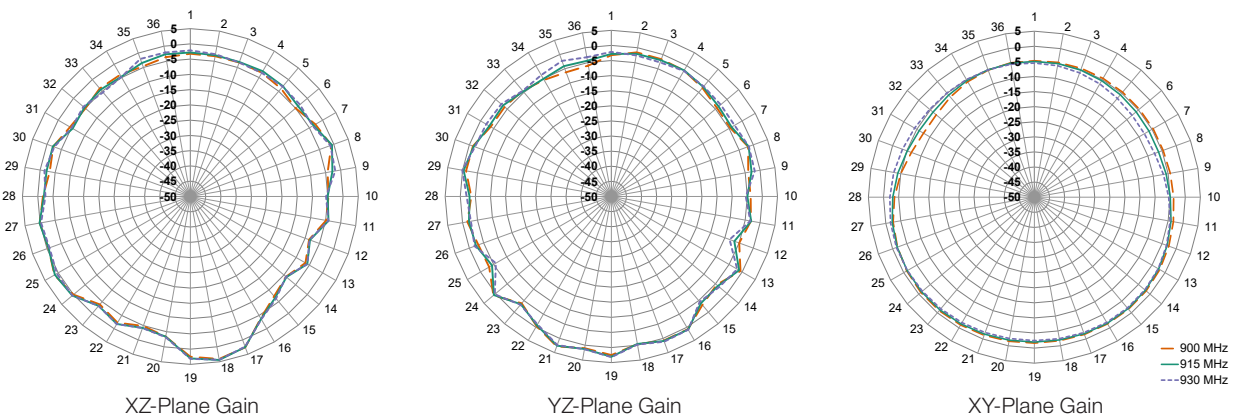

Figure 16. Radiation Patterns for ANT-8/9-MMG1-SMA Antenna, Free Space

Website: <http://linxtechnologies.com>
Linx Offices: 159 Ort Lane, Merlin, OR, US 97532
Phone: +1 (541) 471-6256
E-MAIL: info@linxtechnologies.com

Linx Technologies reserves the right to make changes to the product(s) or information contained herein without notice. No liability is assumed as a result of their use or application. No rights under any patent accompany the sale of any such product(s) or information.

Wireless Made Simple is a registered trademark of Linx Acquisitions LLC. LoRaWAN is a registered trademark of Semtech Corporation. Sigfox is a registered trademark of SIGFOX. Other product and brand names may be trademarks or registered trademarks of their respective owners.

Copyright © 2022 Linx Technologies

All Rights Reserved

Doc# DS22165-228ANT Replaces (DS22160-228ANT)

