



MELCHER™
The Power Partners.

LRSA Series

AC-DC Subrack System

The LRSA product series is a power supply system designed for railway and subway applications. The applicable railway standards, mainly EN 50155, EN 50121-4, and the respective AREMA standards are observed. The power supply system is designed to accommodate special LR converters, such as LR2320-9 or LR2540-9.

A main feature is the enhanced voltage isolation (3000 VAC) between outputs, alarm signals, and the metallic chassis respectively the ground.

The system consists of one rack. The rack can accommodate up to 6 converters, which allows redundant configuration in terms of input and output energy.

A change-over relay contact is available to monitor the function of output voltage. Inhibit function is available to remote on/off.



FEATURES

- Compliant to AREMA, EN 50155, and EN 50121-4
- RoHS compliant for all 6 substances
- 5 year warranty
- 19-inch rack system, convection cooling
- Extremely rugged, reliable design for harsh environment
- Class I equipment
- Extremely high isolation of all output circuits
- Excellent surge and transient protection
- Wide input voltage range 90 to 264 VAC, 50 to 60 Hz
- Power factor >0.93, harmonics IEC/EN 61000-3-2
- Active output current sharing
- Output voltage monitor with change-over relay contacts
- Inrush current limitation
- Hot swappable
- Inhibit function
- Safety approved to UL/CSA 62368-1 & IEC/EN 62368-1



Table of Contents

Page

Page

Description.....	1	Electromagnetic Compatibility (EMC).....	11
Model Selection.....	2	Immunity to Environmental Conditions.....	12
Functional Description.....	6	Mechanical Data.....	13
Electrical Input Data.....	7	Safety and Installation Instructions.....	15
Electrical Output Data.....	9	Accessories.....	17

MODEL SELECTION

The system consists of LR series AC-DC converters and a 19" shelf.

Table 1: Converters. Other output configurations or special customer adaptations are available on request.

Output 1		Output 2		Operating input range		Type designation	Efficiency	
$V_{o\ nom}$ [VDC]	$I_{o\ nom}$ [A]	$V_{o\ nom}$ [VDC]	$I_{o\ nom}$ [A]	$V_{i\ min} - V_{i\ max}$ [VAC]	$f_{i\ min} - f_{i\ max}$ [Hz]		η_{min}^1 [%]	η_{typ} [%]
12	10	12 ²	10	90 – 264	47 – 63	LR2320-9	90	92
15	8	15 ²	8	90 - 264	47 - 63	LR2540-9	90	92

¹ Min. efficiency at $V_i = 230\ V$, $I_{o\ nom}$ and $T_A = 25\ ^\circ C$

² Second output semi-regulated















Table 2a: Single output systems (see Fig. 2).

SINGLE OUTPUT SYSTEMS					
Type designation of the system	Output current		Output power	Population	Configuration of the converters in the rack
	$V_{o\ nom}$	$I_{o\ nom}$	$P_{o\ nom}$		
LRSA20-12-900	1 x 12 V	1 x 20 A	240 W	1 x LR2320-9	
LRSA40-12-900	1 x 12 V	1 x 40 A	480 W	2 x LR2320-9	
LRSA60-12-900	1 x 12 V	1 x 60 A	720 W	3 x LR2320-9	
LRSA80-12-900	1 x 12 V	1 x 80 A	960 W	4 x LR2320-9	
LRSA100-12-900	1 x 12 V	1 x 100 A	1200 W	5 x LR2320-9	
LRSA120-12-900	1 x 12 V	1 x 120 A	1440 W	6 x LR2320-9	
LRSA16-15-900	1 x 15 V	1 x 16 A	240 W	1 x LR2540-9	
LRSA32-15-900	1 x 15 V	1 x 32 A	480 W	2 x LR2540-9	
LRSA48-15-900	1 x 15 V	1 x 48 A	720 W	3 x LR2540-9	
LRSA64-15-900	1 x 15 V	1 x 64 A	960 W	4 x LR2540-9	
LRSA80-15-900	1 x 15 V	1 x 80 A	1200 W	5 x LR2540-9	
LRSA96-15-900	1 x 15 V	1 x 96 A	1440 W	6 x LR2540-9	
LRSA10-24-900	1 x 24 V	1 x 10 A	240 W	1 x LR2320-9	
LRSA20-24-900	1 x 24 V	1 x 20 A	480 W	2 x LR2320-9	
LRSA30-24-900	1 x 24 V	1 x 30 A	720 W	3 x LR2320-9	
LRSA40-24-900	1 x 24 V	1 x 40 A	960 W	4 x LR2320-9	
LRSA50-24-900	1 x 24 V	1 x 50 A	1200 W	5 x LR2320-9	
LRSA60-24-900	1 x 24 V	1 x 60 A	1440 W	6 x LR2320-9	
LRSA08-28-900	1 x 28 V	1 x 8 A	224 W	1 x LR2540-9	
LRSA16-28-900	1 x 28 V	1 x 16 A	448 W	2 x LR2540-9	
LRSA24-28-900	1 x 28 V	1 x 24 A	672 W	3 x LR2540-9	
LRSA32-28-900	1 x 28 V	1 x 32 A	896 W	4 x LR2540-9	
LRSA40-28-900	1 x 28 V	1 x 40 A	1120 W	5 x LR2540-9	
LRSA48-28-900	1 x 28 V	1 x 48 A	1344 W	6 x LR2540-9	
LRSA08-30-900	1 x 30 V	1 x 8 A	240 W	1 x LR2540-9	
LRSA16-30-900	1 x 30 V	1 x 16 A	480 W	2 x LR2540-9	
LRSA24-30-900	1 x 30 V	1 x 24 A	720 W	3 x LR2540-9	
LRSA32-30-900	1 x 30 V	1 x 32 A	960 W	4 x LR2540-9	
LRSA40-30-900	1 x 30 V	1 x 40 A	1200 W	5 x LR2540-9	
LRSA48-30-900	1 x 30 V	1 x 48 A	1440 W	6 x LR2540-9	

LRSA10-48-900	1 x 48 V	1 x 10 A	480 W	2 x LR2320-9	
LRSA20-48-900	1 x 48 V	1 x 20 A	960 W	4 x LR2320-9	
LRSA30-48-900	1 x 48 V	1 x 30 A	1440 W	6 x LR2320-9	
LRSA08-60-900	1 x 60 V	1 x 8 A	480 W	2 x LR2540-9	
LRSA16-60-900	1 x 60 V	1 x 16 A	960 W	4 x LR2540-9	
LRSA24-60-900	1 x 60 V	1 x 24 A	1440 W	6 x LR2540-9	

Note: Single output system has single input. It is possible to have two independent inputs, but it is necessary to change the part number => LRSAXX-XX-XX1

Table 2b: Double output systems

DOUBLE OUTPUT SYSTEMS					
Type designation of the system	Output current		Output power	Population	Configuration of the converters in the rack
	$V_{o\ nom}$	$I_{o\ nom}$	$P_{o\ nom}$		
LRSA2020-1212-901	2 x 12 V	2 x 20 A	2 x 240 W	2 x LR2320-9	
LRSA4040-1212-901	2 x 12 V	2 x 40 A	2 x 480 W	4 x LR2320-9	
LRSA6060-1212-901	2 x 12 V	2 x 60 A	2 x 720 W	6 x LR2320-9	
LRSA1616-1515-901	2 x 15 V	2 x 16 A	2 x 240 W	2 x LR2540-9	
LRSA3232-1515-901	2 x 15 V	2 x 32 A	2 x 480 W	4 x LR2540-9	
LRSA4848-1515-901	2 x 15 V	2 x 48 A	2 x 720 W	6 x LR2540-9	
LRSA1010-2424-901	2 x 24 V	2 x 10 A	2 x 240 W	2 x LR2320-9	
LRSA2020-2424-901	2 x 24 V	2 x 20 A	2 x 480 W	4 x LR2320-9	
LRSA3030-2424-901	2 x 24 V	2 x 30 A	2 x 720 W	6 x LR2320-9	
LRSA0808-2828-901	2 x 28 V	2 x 8 A	2 x 224 W	2 x LR2540-9	
LRSA1616-2828-901	2 x 28 V	2 x 16 A	2 x 448 W	4 x LR2540-9	
LRSA2424-2828-901	2 x 28 V	2 x 24 A	2 x 672 W	6 x LR2540-9	
LRSA0808-3030-901	2 x 30 V	2 x 8 A	2 x 240 W	2 x LR2540-9	
LRSA1616-3030-901	2 x 30 V	2 x 16 A	2 x 480 W	4 x LR2540-9	
LRSA2424-3030-901	2 x 30 V	2 x 24 A	2 x 720 W	6 x LR2540-9	



Note: Each output of system has its own independent input. It is possible to have one input and two outputs, but it is necessary to change the part number => LRSAXXXX-XXXX-XX0

Table 2c: Double output systems - not identical output voltage on sections

DOUBLE OUTPUT SYSTEMS - NOT IDENTICAL OUTPUT VOLTAGE ON SECTIONS					
Type designation of the system	Output current		Output power	Population	Configuration of the converters in the rack
	$V_{o\ nom}$	$I_{o\ nom}$	$P_{o\ nom}$		
LRSA2016-1215-900	1 x 12 V, 1 x 15 V	1 x 20 A, 1 x 16 A	1 x 240 W, 1 x 240 W	1 x LR2320-9, 1 x LR2540-9	[Occupied] [Empty] [Empty] [Empty] [Occupied]
LRSA4032-1215-900	1 x 12 V, 1 x 15 V	1 x 40 A, 1 x 32 A	1 x 480 W, 1 x 480 W	2 x LR2320-9, 2 x LR2540-9	[Occupied] [Empty] [Empty] [Occupied]
LRSA6048-1215-900	1 x 12 V, 1 x 15 V	1 x 60 A, 1 x 48 A	1 x 720 W, 1 x 720 W	3 x LR2320-9, 3 x LR2540-9	[Occupied] [Occupied] [Occupied]
LRSA2010-1224-900	1 x 12 V, 1 x 24 V	1 x 20 A, 1 x 10 A	1 x 240 W, 1 x 240 W	1 x LR2320-9, 1 x LR2320-9	[Empty] [Empty] [Empty] [Empty] [Occupied]
LRSA4020-1224-900	1 x 12 V, 1 x 24 V	1 x 40 A, 1 x 20 A	1 x 480 W, 1 x 480 W	2 x LR2320-9, 2 x LR2320-9	[Occupied] [Empty] [Empty] [Occupied]
LRSA6030-1224-900	1 x 12 V, 1 x 24 V	1 x 60 A, 1 x 30 A	1 x 720 W, 1 x 720 W	3 x LR2320-9, 3 x LR2320-9	[Occupied] [Occupied] [Occupied]
LRSA2008-1228-900	1 x 12 V, 1 x 28 V	1 x 20 A, 1 x 8 A	1 x 240 W, 1 x 224 W	1 x LR2320-9, 1 x LR2540-9	[Empty] [Empty] [Empty] [Empty] [Occupied]
LRSA4016-1228-900	1 x 12 V, 1 x 28 V	1 x 40 A, 1 x 16 A	1 x 480 W, 1 x 448 W	2 x LR2320-9, 2 x LR2540-9	[Occupied] [Empty] [Empty] [Occupied]
LRSA6024-1228-900	1 x 12 V, 1 x 28 V	1 x 60 A, 1 x 24 A	1 x 720 W, 1 x 672 W	3 x LR2320-9, 3 x LR2540-9	[Occupied] [Occupied] [Occupied]
LRSA2008-1230-900	1 x 12 V, 1 x 30 V	1 x 20 A, 1 x 8 A	1 x 240 W, 1 x 240 W	1 x LR2320-9, 1 x LR2540-9	[Empty] [Empty] [Empty] [Empty] [Occupied]
LRSA4016-1230-900	1 x 12 V, 1 x 30 V	1 x 40 A, 1 x 16 A	1 x 480 W, 1 x 480 W	2 x LR2320-9, 2 x LR2540-9	[Occupied] [Empty] [Empty] [Occupied]
LRSA6024-1230-900	1 x 12 V, 1 x 30 V	1 x 60 A, 1 x 24 A	1 x 720 W, 1 x 720 W	3 x LR2320-9, 3 x LR2540-9	[Occupied] [Occupied] [Occupied]
LRSA1610-1524-900	1 x 15 V, 1 x 24 V	1 x 16 A, 1 x 10 A	1 x 240 W, 1 x 240 W	1 x LR2540-9, 1 x LR2320-9	[Empty] [Empty] [Empty] [Empty] [Occupied]
LRSA3220-1524-900	1 x 15 V, 1 x 24 V	1 x 32 A, 1 x 20 A	1 x 480 W, 1 x 480 W	2 x LR2540-9, 2 x LR2320-9	[Occupied] [Empty] [Empty] [Occupied]
LRSA4830-1524-900	1 x 15 V, 1 x 24 V	1 x 48 A, 1 x 30 A	1 x 720 W, 1 x 720 W	3 x LR2540-9, 3 x LR2320-9	[Occupied] [Occupied] [Occupied]
LRSA1608-1528-900	1 x 15 V, 1 x 28 V	1 x 16 A, 1 x 8 A	1 x 240 W, 1 x 224 W	1 x LR2540-9, 1 x LR2540-9	[Empty] [Empty] [Empty] [Empty] [Occupied]
LRSA3216-1528-900	1 x 15 V, 1 x 28 V	1 x 32 A, 1 x 16 A	1 x 480 W, 1 x 448 W	2 x LR2540-9, 2 x LR2540-9	[Occupied] [Empty] [Empty] [Occupied]
LRSA4824-1528-900	1 x 15 V, 1 x 28 V	1 x 48 A, 1 x 24 A	1 x 720 W, 1 x 672 W	3 x LR2540-9, 3 x LR2540-9	[Occupied] [Occupied] [Occupied]
LRSA1608-1530-900	1 x 15 V, 1 x 30 V	1 x 16 A, 1 x 8 A	1 x 240 W, 1 x 240 W	1 x LR2540-9, 1 x LR2540-9	[Empty] [Empty] [Empty] [Empty] [Occupied]
LRSA3216-1530-900	1 x 15 V, 1 x 30 V	1 x 32 A, 1 x 16 A	1 x 480 W, 1 x 480 W	2 x LR2540-9, 2 x LR2540-9	[Occupied] [Empty] [Empty] [Occupied]
LRSA4824-1530-900	1 x 15 V, 1 x 30 V	1 x 48 A, 1 x 24 A	1 x 720 W, 1 x 720 W	3 x LR2540-9, 3 x LR2540-9	[Occupied] [Occupied] [Occupied]
LRSA1008-2430-900	1 x 24 V, 1 x 30 V	1 x 10 A, 1 x 8 A	1 x 240 W, 1 x 240 W	1 x LR2320-9, 1 x LR2540-9	[Empty] [Empty] [Empty] [Empty] [Occupied]
LRSA2016-2430-900	1 x 24 V, 1 x 30 V	1 x 20 A, 1 x 16 A	1 x 480 W, 1 x 480 W	2 x LR2320-9, 2 x LR2540-9	[Occupied] [Empty] [Empty] [Occupied]
LRSA3024-2430-900	1 x 24 V, 1 x 30 V	1 x 30 A, 1 x 24 A	1 x 720 W, 1 x 720 W	3 x LR2320-9, 3 x LR2540-9	[Occupied] [Occupied] [Occupied]
LRSA1008-2428-900	1 x 24 V, 1 x 28 V	1 x 10 A, 1 x 8 A	1 x 240 W, 1 x 224 W	1 x LR2320-9, 1 x LR2540-9	[Empty] [Empty] [Empty] [Empty] [Occupied]
LRSA2016-2428-900	1 x 24 V, 1 x 28 V	1 x 20 A, 1 x 16 A	1 x 480 W, 1 x 448 W	2 x LR2320-9, 2 x LR2540-9	[Occupied] [Empty] [Empty] [Occupied]
LRSA3024-2428-900	1 x 24 V, 1 x 28 V	1 x 30 A, 1 x 24 A	1 x 720 W, 1 x 672 W	3 x LR2320-9, 3 x LR2540-9	[Occupied] [Occupied] [Occupied]

Note: Outputs of system has one common input. It is possible to have two outputs and two independent inputs, but it is necessary to change the part number => LRSAXXXX-XXXX-XX1.
(Other configurations or special customer adaptations are available on request)

Note: Positions without a converter are covered with blank panels.

 - occupied position  - empty position

Part Number Description for Single Output System

LRSA 20 48 - 9 0 0 Sxxx

Series (product family)..... LRSA
 Output current..... 08, 10, 16, 20, 24, 30, 32, 40,
 48, 50, 60, 64, 80, 96, 100, 120
 Output voltage 12, 15, 24, 28, 30, 48, 60
 Operating ambient temperature range
 $T_A = -40$ to $+71$ °C -9
 Options: Bel Power logo on front panel0
 Custom logo on front panel5
 Features: Independent input (no, yes) 0, 1
 Customer specific model Sxxx¹

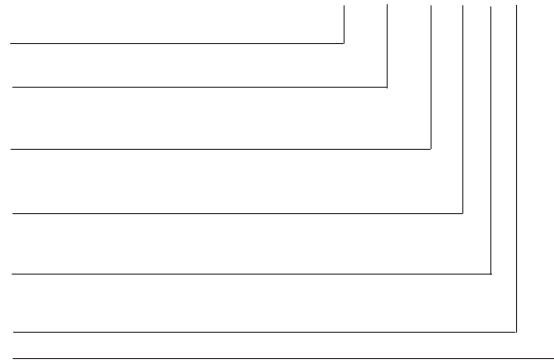

Part Number Description for Double Output System

LRSA 2016-1215 - 9 0 0 Sxxx

Series (product family)..... LRSA
 Output current..... 08, 10, 16, 20, 24, 30, 32, 40, 48, 60
 Output voltage 12, 15, 24, 28, 30
 Operating ambient temperature range
 $T_A = -40$ to $+71$ °C -9
 Options: Bel Power logo on front panel0
 Custom logo on front panel5
 Features: Independent input (no, yes) 0, 1
 Customer specific model Sxxx¹

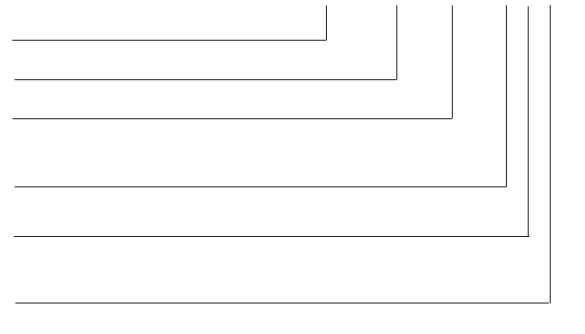

¹ Applicable for non safety critical deviations. xxx are 3 digits assigned for each customer-specific model

FUNCTIONAL DESCRIPTION

The input voltage is supplied to up to 6 converters type LR2320-9 / LR2540-9. The outputs of each section of rack are connected in series generating 48 V / 60 V or in parallel generating 12 V, 15 V, 24 V, 30 V. Converters of each section of rack are connected parallel through OR-ing mosfets.

In parallel version of rack (12 V, 15 V, 24 V, 30 V) two sections share their output current evenly due their current share feature. The LR2320-9 converters have two 12 V outputs and the LR2540-9 have two 15 V outputs, which can be connected in parallel or in series. The connection of the outputs is done in the factory by the output voltage selector on the backplane.

The output voltage is monitored in each converter. When the output voltage is in range, a relay with an isolated change-over contact is activated. All relay contacts are connected to the alarm OUT OK connectors.

Inhibit function is available to remote on/off. When the pins of inhibit connector are not connected together, converters will be disabled.

The redundancy of the whole system is depending on the numbers of the converters; see Table 2.

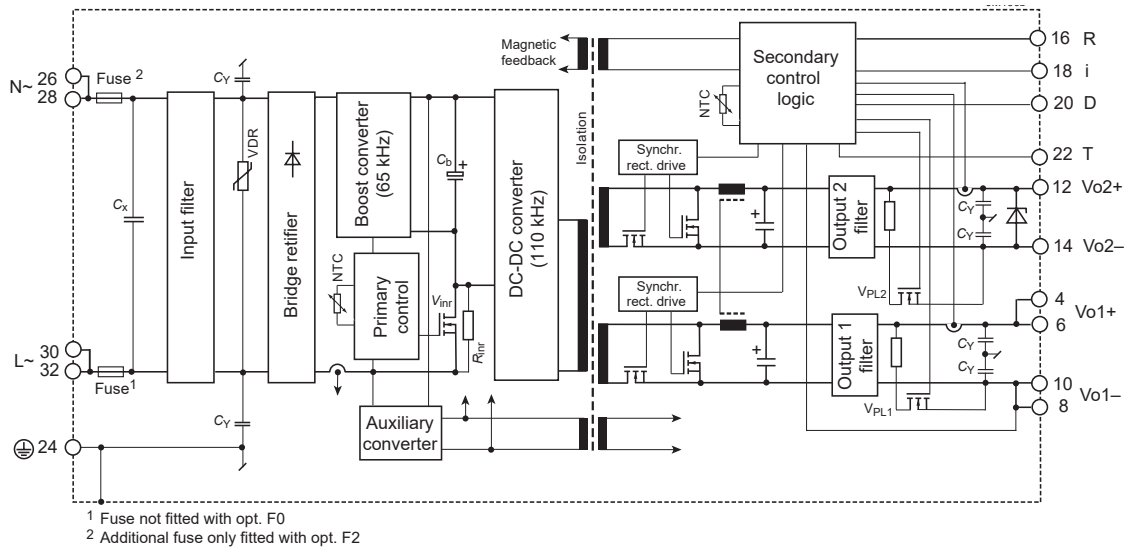

Fig. 1
Block diagram of a LR series AC-DC converter

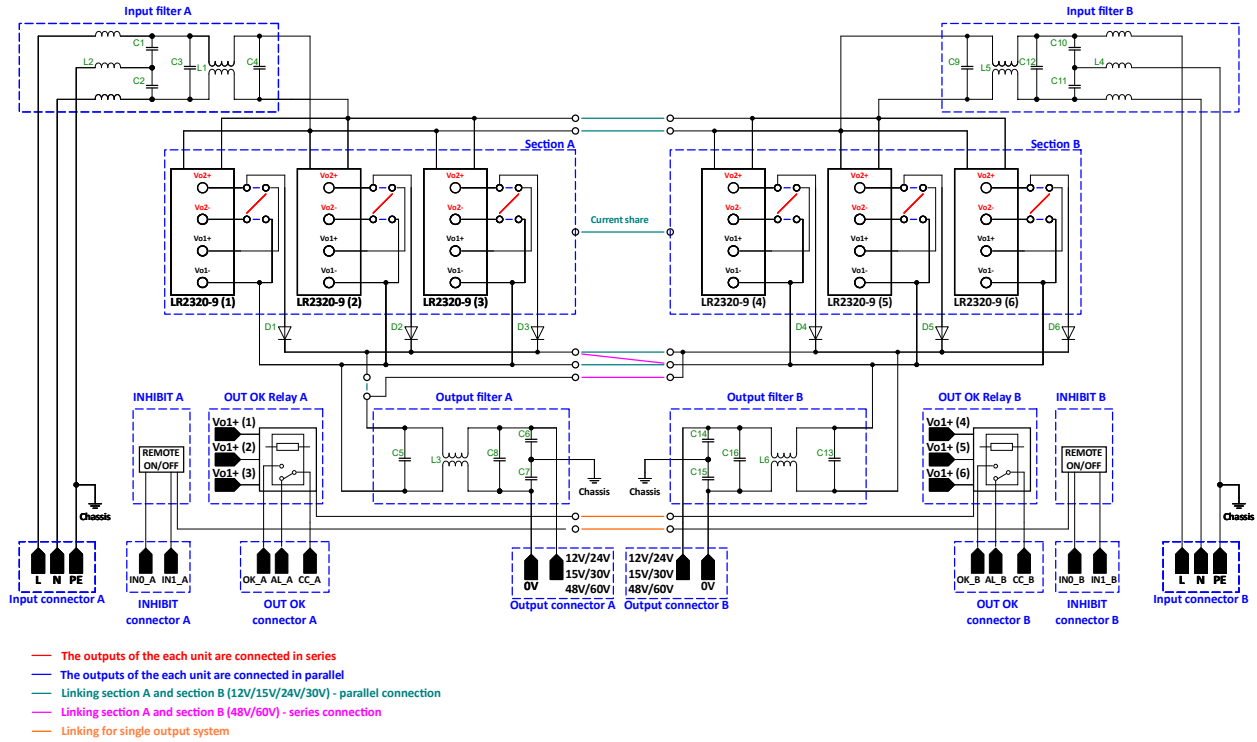

Fig. 2
Block diagram of the rack. The converters in the different positions are fitted depending on the configuration; see table 2.
For details of contacts and wires, see Mechanical Data.

ELECTRICAL INPUT DATA

General Conditions:

- $T_A = 25 \text{ }^\circ\text{C}$, unless T_C is specified.
- Pin 18 (i) connected to pin 8, pin 16 (R), pin 18 (D), and pin 22 (T) left open-circuit.

Table 3: Electrical input data per converter

Input		Conditions	LR2320-9			LR2540-9			Unit
Characteristics			min	typ	max	min	typ	max	
V_i	Rated input voltage range	$I_o = 0 - I_{o,nom}$	100		240	100		240	VAC ¹
$V_{i,op}$	Operating input voltage range	$T_{C,min}$ to $T_{C,max}$	90		264	90		264	
$V_{i,nom}$	Nominal input voltage	50 – 60 Hz ¹	110 / 230		110 / 230				
I_i	Input current per converter	$V_i = 230 \text{ V}, I_{o,nom}$ ²	1.2			1.2		A	
P_{i0}	No-load input power per converter	$V_{i,min} - V_{i,max}, I_o = 0$			15			15	W
$P_{i,inh}$	Idle input power	Converter inhibited	1.3		2	1.3		2	
C_b	Input capacitance per converter		360			360		μF	
$V_{i,abs}$	Input voltage limits without damage		-400		400 ³	-400		400 ³	VDC ³

¹ Rated input frequency: 50 – 60 Hz, operating input frequency: 47 – 63 Hz.

² Outputs loaded with $I_{o,nom}$

³ For $\leq 1 \text{ s}$.

Input Fuse and Protection of the Converters

A VDR together with the input fuse and a symmetrical input filter form an effective protection against high input transient voltages. Input fuse: slow-blow, 6.3 A, 250 V, slow, 5 × 20 mm.

This applies only for modules/converters. The backplane has no additional protection (fuse, VDR).

Input Under-/Overvoltage Lockout

If the input voltage remains below approx. 80 VAC or exceeds $V_{i\text{op max}}$, an internally generated inhibit signal disables the outputs. Do not check the overvoltage lockout function!

If V_i is below $V_{i\text{min}}$, but above the undervoltage lockout level, the output voltage may be below the value specified in the tables *Electrical Output Data*.

Efficiency

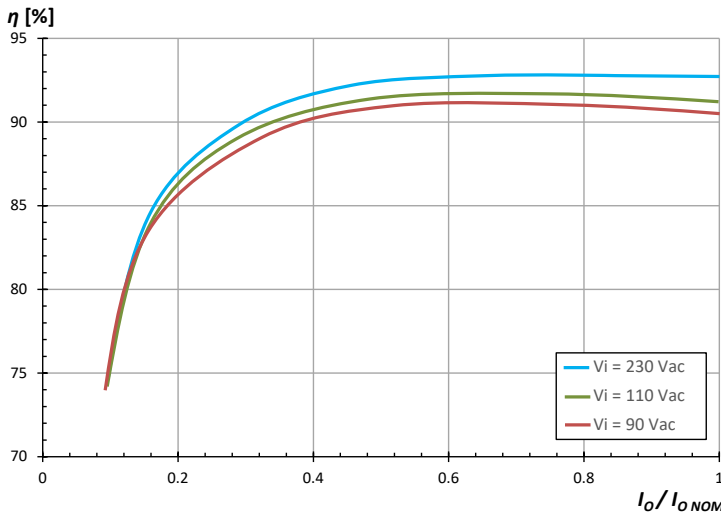

Fig. 3
Efficiency versus V_i and I_o (LRP2320 / LRP2540, both outputs connected in series)

Power Factor and Harmonics

Power factor correction is achieved by controlling the input current waveform synchronously with the input voltage waveform. The power factor control is active under all operating conditions.

Harmonic distortions are below the limits specified in IEC/EN 61000-3-2, class A.

Hold-up time

The integrated storage capacitor (C_b) is loaded to the boost voltage and ensures full output voltage with nominal load during the specified interruption time of 20 ms.

Inrush Current Limitation

The converters exhibit an electronic circuit to limit the inrush current at switch-on.

ELECTRICAL OUTPUT DATA

Table 4a: Output data of the converter connected in series

Model			LR2320-9			LR2540-9			Unit
Characteristics			Conditions			Output 1 + 2 in series			
			min	typ	max	min	typ	max	
V_o	Output voltage	$V_{i\ nom}, I_{o\ nom}$		24			30 (28) ¹		V
$I_{o\ nom}$	Output current nom.	$V_{i\ min} - V_{i\ max}, T_{C\ min} - T_{C\ max}$		10			8		A
I_{oL}	Output current limit	$V_{i\ min} - V_{i\ max}$	10.5			8.4			
$\Delta V_{o\ u}$	Static line regulation with respect to $V_{i\ nom}$	$V_{i\ min} - V_{i\ max}, I_{o\ nom}$			±120			±150	mV
$\Delta V_{o\ l}$	Static load regulation ¹	$V_{i\ nom}, (0.1 - 1) I_{o\ nom}$			±120			±150	
α_{vo}	Temperature coefficient of output voltage	$T_{C\ min} - T_{C\ max}, I_{o\ nom}$		±0.02			±0.02		%/K

¹ Output voltage is adjusted on the backplane of the rack

Table 4b: Output data of the converter connected in parallel

Model			LR2320-9			LR2540-9			Unit
Characteristics			Conditions			Output 1 + 2 in parallel			
			min	typ	max	min	typ	max	
V_o	Output voltage	$V_{i\ nom}, I_{o\ nom}$		12			15		V
$I_{o\ nom}$	Output current nom.	$V_{i\ min} - V_{i\ max}, T_{C\ min} - T_{C\ max}$		20			16		A
I_{oL}	Output current limit	$V_{i\ min} - V_{i\ max}$	21			16.8			
$\Delta V_{o\ u}$	Static line regulation with respect to $V_{i\ nom}$	$V_{i\ min} - V_{i\ max}, I_{o\ nom}$			±120			±150	mV
$\Delta V_{o\ l}$	Static load regulation ¹	$V_{i\ nom}, (0.1 - 1) I_{o\ nom}$			±120			±150	
α_{vo}	Temperature coefficient of output voltage	$T_{C\ min} - T_{C\ max}, I_{o\ nom}$		±0.02			±0.02		%/K

Thermal Considerations

If a converter is located in free, quasi-stationary air (convection cooling) at the indicated maximum ambient temperature $T_{A\ max}$ (see table *Temperature specifications*) and is operated within the specified input voltage range with nominal load, the temperature measured at the *Measuring point of case temperature* T_C (see *Mechanical Data*) will approach the indicated value $T_{C\ max}$ after the warm-up phase. However, the relationship between T_A and T_C depends heavily upon the conditions of operation and integration into a system. The thermal conditions are influenced by input voltage, output current, airflow, and temperature of surrounding components and surfaces. $T_{A\ max}$ is therefore, contrary to $T_{C\ max}$, an indicative value only.

Caution: The installer must ensure that under all operating conditions T_C remains within the limits stated in the table *Temperature specifications*. If $T_{C\ max}$ is exceeded during operating conditions, an adequate forced cooling of system may be required to sustain $T_{C\ max}$ is within allowed limits.

Thermal Protection of the Converters

Two temperature sensors generate an internal inhibit signal, which disables the converter in case of overtemperature. The outputs automatically recover when the temperature drops below the limit.

Continuous operation under simultaneous extreme worst-case conditions of the following three parameters should be avoided: Minimum input voltage, maximum output power, and maximum temperature.

Output Protection of the Converters

The 2nd output is protected by a suppressor diode against overvoltage, which could occur due to a failure of the internal control circuit. This suppressor diode was not designed to withstand externally applied overvoltages. Overload at any of the outputs will cause both outputs to shut-down.

Note: The output voltage of the first output is monitored. If it exceeds typ. 140% of $V_{o\ nom}$ for 10 ms, the converter is inhibited by a latch. To reactivate, V_i must be removed or the converter disabled through an inhibit signal to pin 18.

Each output has its own current limiting circuit, providing a rectangular output characteristic and protecting against short circuit. There is no limitation for the capacitive load.

Output Voltage Regulation of the Converters

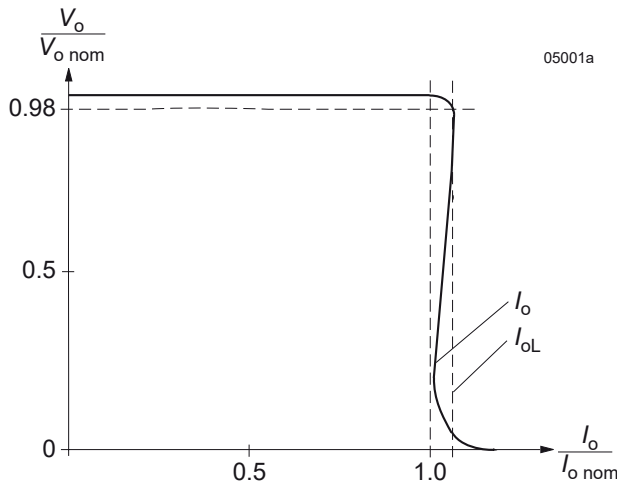

Fig. 4. Typical output characteristic V_o versus I_o .

Inhibit for Remote On/Off

The outputs of units in section A and section B, may be enabled or disabled by inhibit function. If pins of inhibit connector are connected together, the outputs are enabled. If these pins are not connected together, the outputs are disabled.

In the case of single output system, only one inhibit connector is fitted (pins IN0_B, IN1_B).

In case of double output system, both inhibit connectors are fitted (pins IN0_A, IN1_A and IN0_B, IN1_B). The section A and section B have their own inhibit connector.

The inhibit disables the DC-DC converters immediately, without respecting the hold-up time. The input section of the converter is not disabled.

Output Voltage Monitor of the Converters

The output voltage monitor generates a logic “low” signal (NPN open-collector output) at the D-output (pin 20), when $V_{o1} \geq 0.96 V_{o\text{nom}}$ and $\leq 1.04 V_{o\text{nom}}$ (typ. values).

When the output is in range, a relay with a change-over contact located on the backplane is connecting CC with OK. When the output is out of range, a relay is connecting CC with AL.

In case of single output system, only one relay and one OUT OK connector are fitted on the backplane.

In case of double output system, section A and section B have their own relay and OUT OK connector.

LED Indicators

Two green indicators are visible at the front plate:

- Out OK; see *Output Voltage Monitor*
- In OK. This signal is activated, when V_i is in range and the converter is not disabled by the inhibit signal.

ELECTROMAGNETIC COMPATIBILITY (EMC)

The **converters** and populated **subrack systems** successfully been tested to the following specifications:

Immunity

Table 5: Electromagnetic immunity (type tests). Corresponds or Exceeds EN50121-3-2:2016 and AREMA

Phenomenon	Standard	Level	Coupling mode ¹	Value applied	Waveform	Source imped.	Test procedure	In oper.	Perf. crit. ²
Electrostatic discharge (to case)	IEC/EN 61000-4-2	4	contact discharge	$\pm 6000 V_p$	1/50 ns	330 Ω 150 pF	10 pos. & 10 neg. discharges	yes	A
			air discharge	$\pm 8000 V_p$					
Electromagnetic field	IEC/EN 61000-4-3	x	antenna	20 V/m	AM 80% / 1 kHz	N/A	80 – 800 MHz	yes	A
			antenna	20 V/m			1400 – 2000 MHz		
				5 V/m			2000 – 2700 MHz		
				3 V/m			5100 – 6000 MHz		
Electrical fast transients / burst	IEC/EN 61000-4-4	3	capacitive, o/c	$\pm 2000 V_p$	bursts of 5/50 ns; 2.5 / 5 kHz over 15 ms; burst period: 300 ms	50 Ω	60 s positive 60 s negative transients per coupling mode	yes	A
		4	$\pm i/c, +i/-i$ direct	$\pm 4000 V_p$					
Surges	IEC/EN 61000-4-5	3	i/c	$\pm 2000 V_p$	1.2 / 50 μs	12 Ω / 9 μF	5 pos. & 5 neg. surges per coupling mode	yes	A
			i/c, +i/-i	$\pm 2000 V_p$		2 Ω / 18 μF			B
			+i/-i	$\pm 1000 V_p$		2 Ω / 18 μF			A
Conducted disturbances	IEC/EN 61000-4-6	3	i, o, signal wires	10 VAC (140 dB μ V)	AM 80% / 1 kHz	150 Ω	0.15 – 80 MHz	yes	A
Power frequency magnetic field	IEC/EN 61000-4-8	3	-	300 A/m	0 to 50 Hz		60 s in all 3 axes	yes	A

¹ i = input, o = output, c = case

² A = normal operation, no deviation from specs.; B = normal operation, temporary loss of function or deviation from specs possible

Emissions

All models comply with Class A according to EN 55011/55032 for conducted and radiated emissions.

IMMUNITY TO ENVIRONMENTAL CONDITIONS

The populated subrack system has been tested as per table 6.

Table 6: Mechanical and climatic stress

Test method		Standard	Test Conditions		Operating Condition
Cab	Damp heat steady state	IEC/EN 60068-2-78 MIL-STD-810D section 507.2	Temperature:	40 ^{±2} °C	Converter not operating
			Relative humidity:	93 ^{+2/-3} %	
			Duration:	56 days	
Db	Cyclic damp heat test	EN 50155:2017, clause 13.4.7 IEC/EN 60068-2-30	Temperature:	55 °C and 25 °C	Converter not operating
			Cycles (respiration effect)	2	
			Duration:	2x 24 h	
Be	Dry heat test steady state	EN 50155:2017, clause 13.4.5 IEC/EN 60068-2-2	Temperature:	70 °C	Converter operating
			Duration:	6 h	
Ad	Low temperature start-up test	EN 50155:2017, clause 13.4.4 IEC/EN 60068-2-1	Temperature, duration:	-40 °C, 2 h	Converter not operating
			Performance test:	+25 °C	
Ka	Salt mist test sodium chloride (NaCl) solution	EN 50155:2017, clause 13.4.10 IEC/EN 60068-2-11 class ST2	Temperature:	35 ^{±2} °C	Converter not operating
			Duration:	48 h	
Fh	Random vibration broad band (digital control) & guidance	IEC/EN 60068-2-64	Acceleration spectral density:	0.05 g _n ² /Hz	Converter operating
			Frequency band:	8 – 500 Hz	
			Acceleration magnitude:	4.9 g _{n rms}	
			Test duration:	1.5 h (0.5 h in each axis)	
Fc	Vibration (sinusoidal)	IEC/EN 60068-2-6 MIL-STD-810D section 514.3	Acceleration amplitude:	0.35 mm (10 – 60 Hz) 5 g _n = 49 m/s ² (60 - 2000 Hz)	Converter operating
			Frequency (1 Oct/min):	10 – 2000 Hz	
			Test duration:	7.5 h (2.5 h in each axis)	
-	Vibration	AREMA Part. 11.5.1 class B, C, D, E, I, J	Displacement amplitude:	0.3" (5 – 10 Hz) 0.1" (5 – 20 Hz)	Converter operating
			Acceleration amplitude:	2 g _n = 19.6 m/s ² (10 - 200 Hz)	
			Frequency (1 Oct/min):	5 – 200 Hz	
			Test duration:	12 h (4 h in each axis)	
Ea	Shock (half-sinusoidal)	IEC/EN 60068-2-27 MIL-STD-810D section 516.3	Acceleration amplitude:	50 g _n = 490 m/s ²	Converter operating
			Bump duration:	11 ms	
			Number of bumps:	18 (3 in each direction)	
-	Shock	EN 50155:2017 clause 13.4.11, EN 61373 sect. 10, class B, body mounted ¹	Acceleration amplitude:	5.1 g _n	Converter operating
			Bump duration:	30 ms	
			Number of bumps:	18 (3 in each direction)	
-	Mechanical shock	AREMA Part. 11.5.1 class B, C, D, E, I, J	Acceleration amplitude:	10 g _n = 98 m/s ²	Converter operating
			Bump duration:	11 ms	
			Number of bumps:	18 (3 in each direction)	
-	Simulated long life testing at increased random vibration levels	EN 50155:2017 clause 13.4.11.2, EN 61373 sect. 8 and 9, class B, body mounted ¹	Acceleration spectral density:	0.02 g _n ² /Hz	Converter operating
			Frequency band:	5 – 150 Hz	
			Acceleration magnitude:	0.8 g _{n rms}	
			Test duration:	15 h (5 h in each axis)	

¹ Body mounted = chassis of a railway coach

Temperatures

Table 7: Temperature specifications, valid for an air pressure of 800 – 1200 hPa (800 – 1200 mbar)

Model		-9			Unit	
Characteristics		Conditions	min	typ	max	
T_A	Ambient temperature	Converter operating	- 40		45 ^{1,2}	°C
			- 40		71 ^{1,3}	
T_C	Case temperature		- 40		95 ^{1,4}	
T_S	Storage temperature	Not operating	- 55		85	

- ¹ See *Thermal Considerations*.
- ² Natural convection cooling.
- ³ 400 LFM forced air cooling.
- ⁴ Overtemperature lockout at $T_c > 95$ °C. (An NTC resistor on primary and secondary heatsink of converter.)

MECHANICAL DATA

Dimensions in mm. The converters are designed to be inserted into a 19" rack, 160 mm long, according to IEC 60297-3.

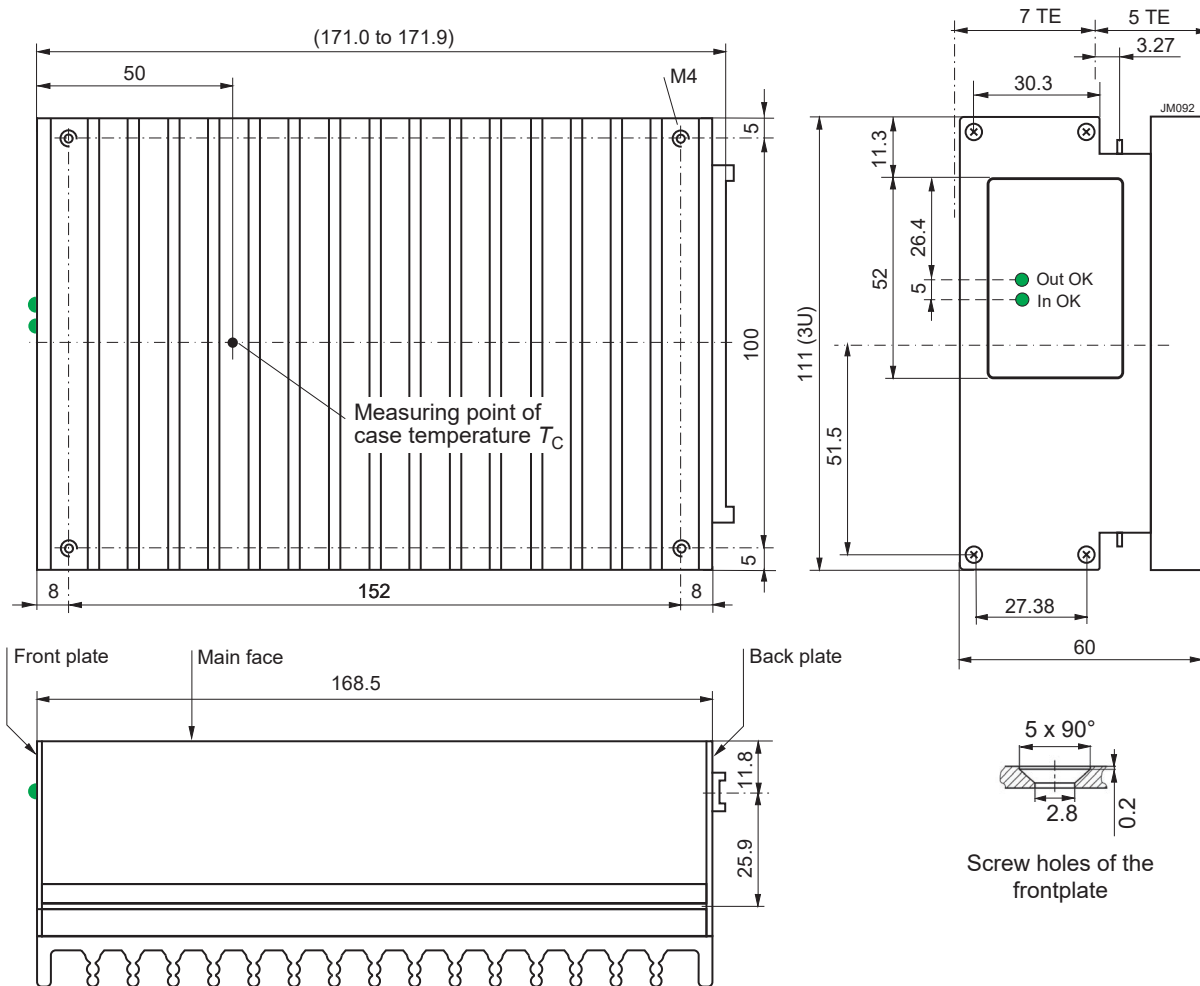

Fig. 5
Aluminum case of LR models with heat sink; black finish (EP powder coated);
weight approx. 1.5 kg

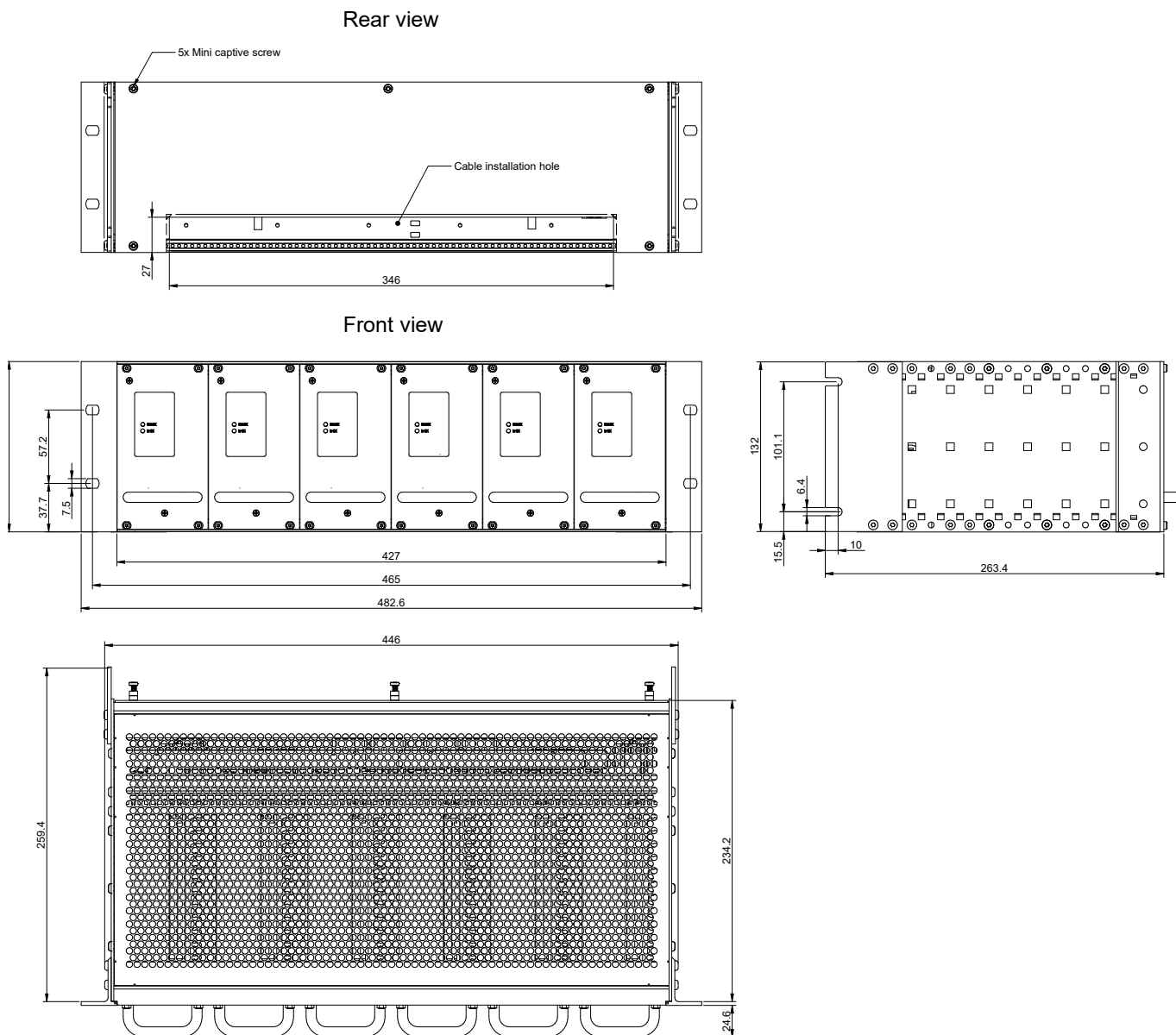

Fig. 6
19" fully assembled rack LRSA30-48-900, dimensions in mm. Weight approx. 2.8 kg (empty rack MK007-500 without converters)

SAFETY AND INSTALLATION INSTRUCTIONS

Please read the Installation Instruction (BCM.20067).

Table 8: Input/output and signal connector pinning

Position		Manufacturer / MPN	# of pins	Min / Max wire cross section ¹
Input A Input B	L	WAGO / 745-1403	3	14 / 10 AWG
	N			14 / 10 AWG
	⊕			14 / 10 AWG
Output A Output B	+Vo	WAGO / 745-602	2	16 / 6 AWG
	- Vo	WAGO / 745-602	2	16 / 6 AWG
OUT OK A OUT OK B		WAGO / 745-103	3	28 / 12 AWG
Inhibit A Inhibit B		WAGO / 745-102	2	28 / 12 AWG

¹ This is min./max. wire cross section fitting to the connector, the used wire cross section depends on maximum output current.

Connector Pin Allocation of the LRSA rack system

Table 9: Input pins allocation

INPUT A, B

Pin No.	Name	Current rating per pin	Max size of interconnecting wire	Wire rating	Function
1	L~	30 A	10 AWG / 6 mm ²	> 300 Vrms, 105°C	Phase line
2	N~	30 A	10 AWG / 6 mm ²	> 300 Vrms, 105°C	Neutral line
3	⊕	30 A	10 AWG / 6 mm ²	> 300 Vrms, 105°C	Protection earth PE and case

Table 10: Output pins allocation

OUTPUT A, B

Pin No.	Name	Current rating per pin	Max size of interconnecting wire	Function
1	Vo-	65 A	6 AWG / 16 mm ²	Negative Output
2	Vo-	65 A	6 AWG / 16 mm ²	Negative Output
3	Vo+	65 A	6 AWG / 16 mm ²	Positive Output
4	Vo+	65 A	6 AWG / 16 mm ²	Positive Output

Table 11: OUT OK A, B pins allocation

OUT OK A, B

Pin No.	Name	Current rating per pin	Max size of interconnecting wire	Function
1	AL	10 A	12 AWG / 4 mm ²	Rest contact
2	CC	10 A	12 AWG / 4 mm ²	Change contact
3	OK	10 A	12 AWG / 4 mm ²	Operating contact (Vo okay)

Table 12: INHIBIT A, B pins allocation

INHIBIT A, B

Pin No.	Name	Current rating per pin	Max size of interconnecting wire	Function
1	IN1	10 A	12 AWG / 4 mm ²	Inhibit positive
2	IN0	10 A	12 AWG / 4 mm ²	Inhibit negative

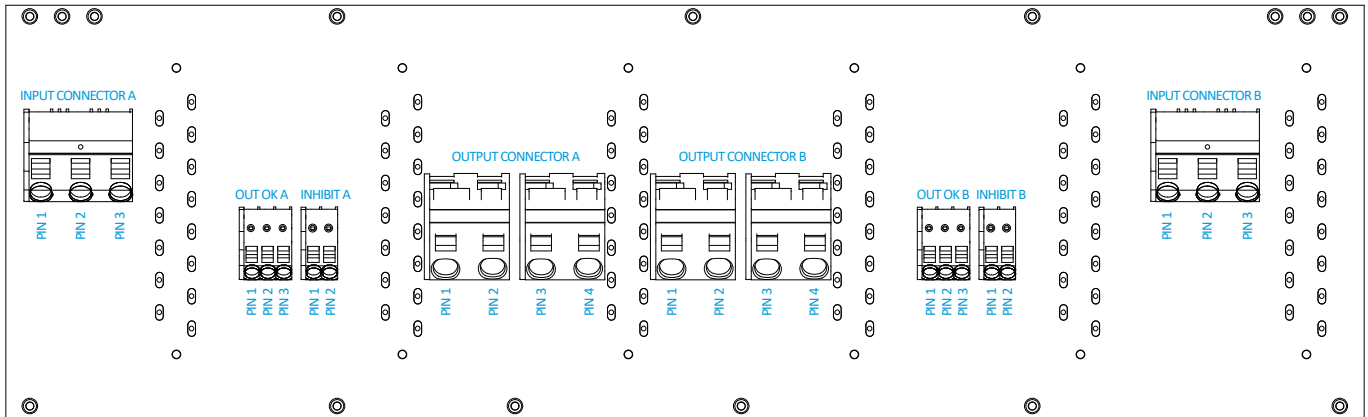

Fig. 7
Layout of the connectors on the backplane
Note: This layout is for dual output systems. For single output systems, only section B connectors are placed.

Standards and Approvals

The LRSA series subrack system is approved according to IEC/EN 62368-1. The converters are safety-approved to UL/CSA 62368-1 and IEC/EN 62368-1.

The converters correspond to Class I equipment (case connected to ground). They have been evaluated for:

- Building-in
- Basic insulation between input and case based on 250 VA; basic insulation between outputs and case; double or reinforced insulation between input and outputs
- Functional insulation between outputs
- Overvoltage category II
- Pollution degree 2 environment
- Max. altitude: 2000 m
- IP40 (from the front side)
- The converters fulfil the requirements of a fire enclosure

The output voltage is considered as ES1. The converters are subject to manufacturing surveillance in accordance with the above mentioned safety standards and with ISO 9001:2015, IRIS ISO/TS 22163:2017 certified quality and business management system. CB-scheme is available on request.

Touch Currents per Converter

Touch currents flow due to internal leakage capacitances and Y-caps. The current values are proportional to the voltage and frequency of the supply. They are specified in the Table 13.

Table 13: Touch currents per converter

Characteristics		Class I	Unit
Maximum touch current	Permissible according to IEC/EN 62368-1	5.0	mA
	Typ. value at 264 V, 50 Hz; per converter	1.0	

Protective Lacquer

All boards of the converters are coated with a protective lacquer. The rack including the back plane is designed with higher creepage distances and clearances, but is not protected by lacquer.

Isolation and Protective Earth

The electric strength test is performed in the factory as routine test according to EN 62911 and IEC/EN 62368-1 and should not be repeated in the field. The company will not honor any warranty claims resulting from incorrectly executed electric strength field tests. The resistance between case and earth pin (<0.1 Ω) is tested as well.

Table 14: Isolation

Characteristics		Input to Case + Output(s)	Output(s) to Case and Input	Output 1 to Output 2	Unit
Electric strength test	Factory test 10 s	2.84 ¹	4.3	0.5	kVDC
	AC test voltage equivalent to factory test	2.0 ¹	3.0	0.3	kVAC
Insulation resistance at 500 VDC		>300	>300	>300	MΩ
Creepage distances		≥ 3.5 ²	≥ 4.5	---	mm

¹ Subassemblies connecting input to output are pre-tested with 5.6 kVDC or 4 kVAC.

² Input to outputs: 7.0 mm

Protective earthing of the LRSA subrack system is provided by inserting wire to the Input connector (pin 3) and additionally wire mounted to grounding screw – see Fig. 8 below. Each wire used for grounding must have minimal cross section 2.5 mm² (14 AWG).

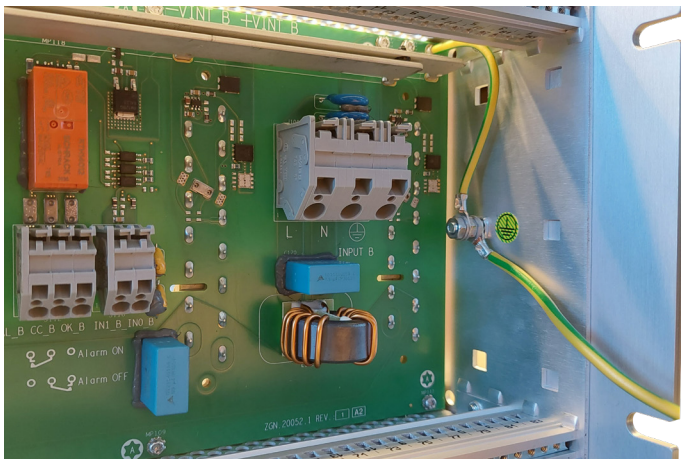

Fig. 8
Protective earthing of LRSA subrack system

ACCESSORIES

Blank Panel / Filler: HZZ02018G

Single modules LR2320-9: YPA.20372.0 / LR2540-9: YPA.20373.0



Fig. 9
Blank Panel HZZ02018G



Fig. 10
Single module LR2320-9 (YPA.20372.0) / LR2540-9 (YPA.20373.0)

NUCLEAR AND MEDICAL APPLICATIONS - These products are not designed or intended for use as critical components in life support systems, equipment used in hazardous environments, or nuclear control systems.

TECHNICAL REVISIONS - The appearance of products, including safety agency certifications pictured on labels, may change depending on the date manufactured. Specifications are subject to change without notice.