

STELLA-FRESNEL

~25° beam for warehouse and outdoor lighting.
Compatible with up to 30 mm LES size COBs.
Variant with black frame.

SPECIFICATION:

Dimensions	Ø 90.0 mm
Height	23 mm
Fastening	screw
Ingress protection classes	IP67
ROHS compliant	yes ⓘ



MATERIALS:

Component	Type	Material	Colour	Finish
STELLA-FRESNEL	Single lens	Silicone	clear	
STELLA-FRAME	Holder	PA66	black	





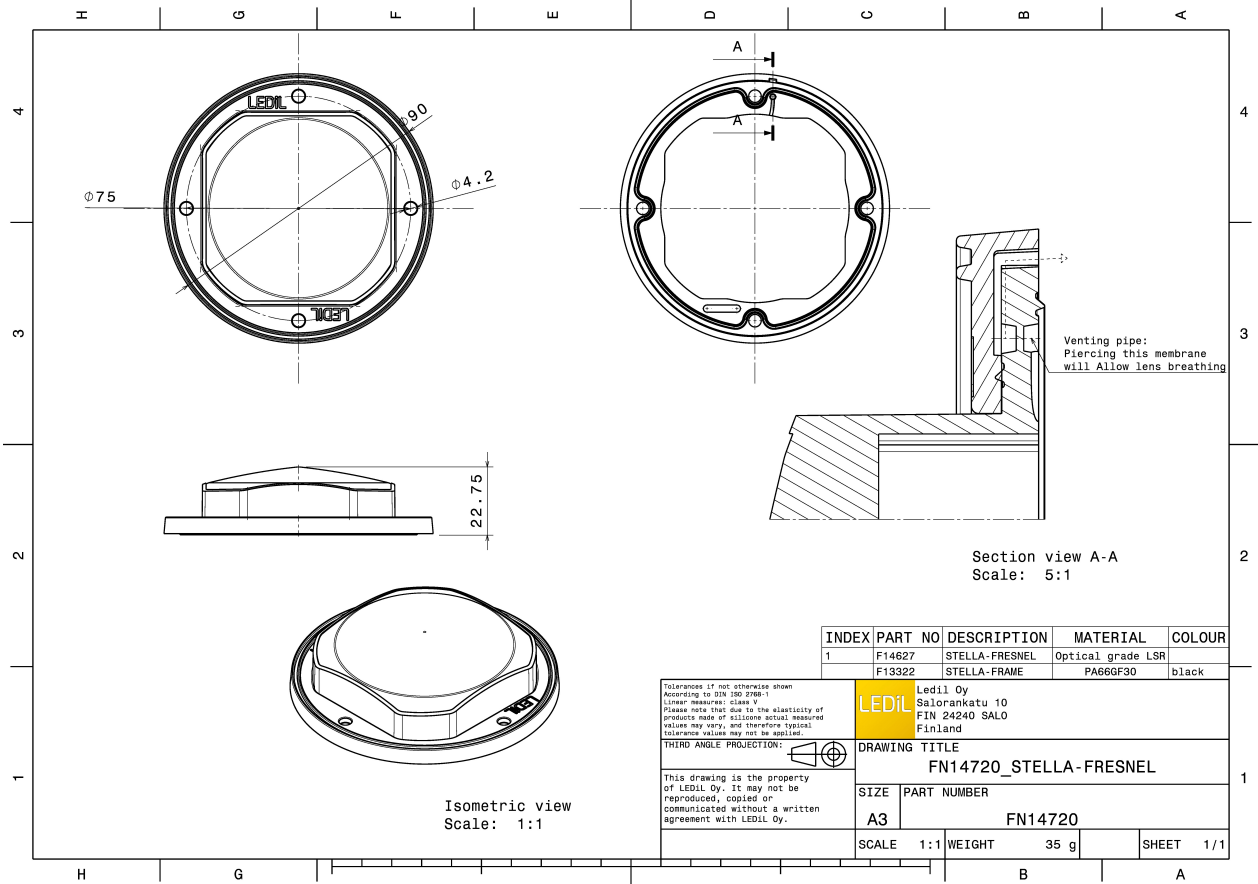

ORDERING INFORMATION:

Component	Type	Qty in box	MOQ	MPQ	Box weight (kg)
FN14720_STELLA-FRESNEL » Box size: 480 x 280 x 300 mm	Single lens	80	80	10	4.0

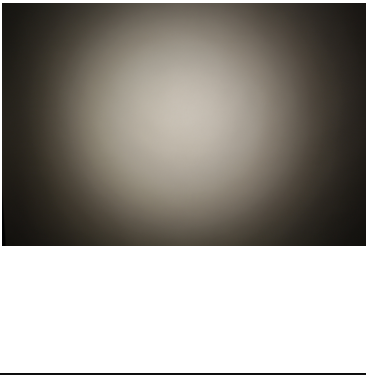
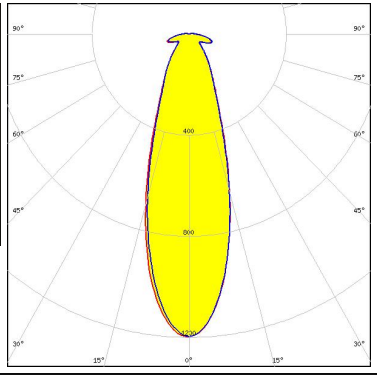

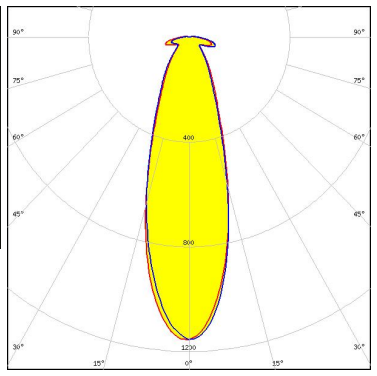

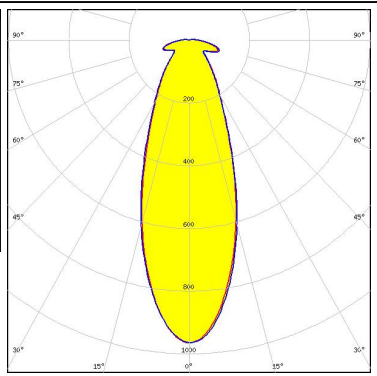

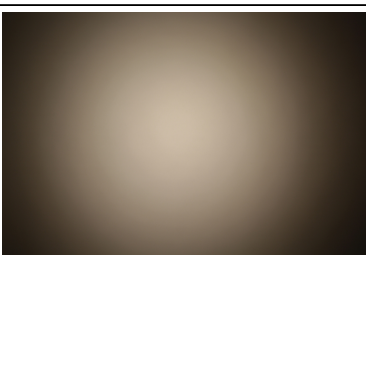
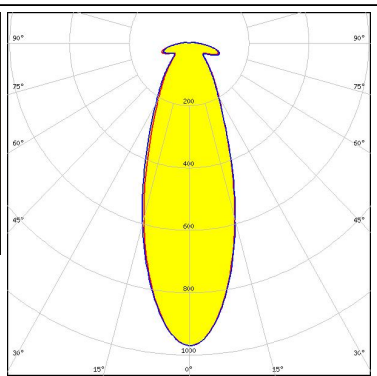

See also our general installation guide: www.ledil.com/installation_guide

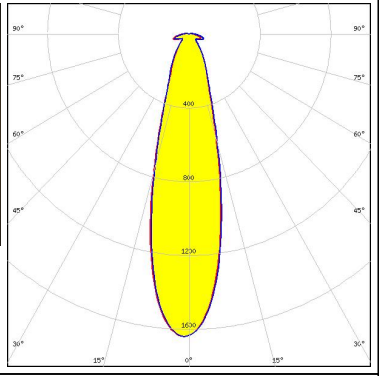
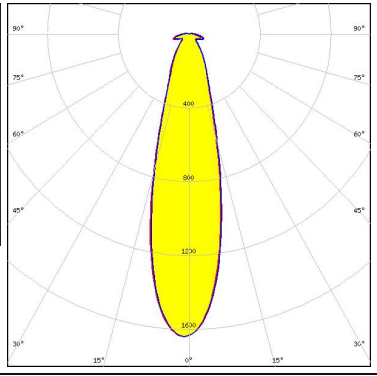
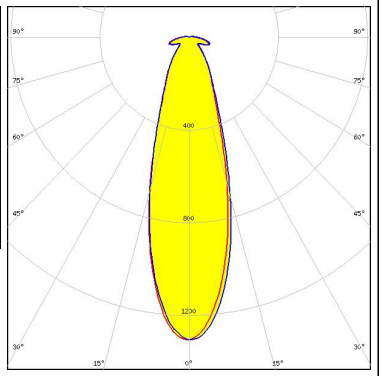

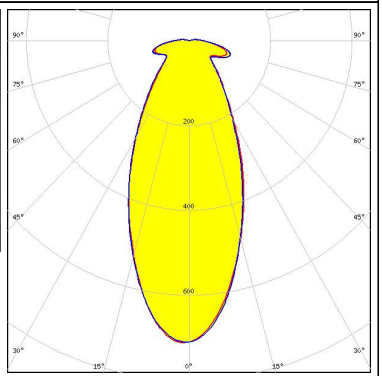

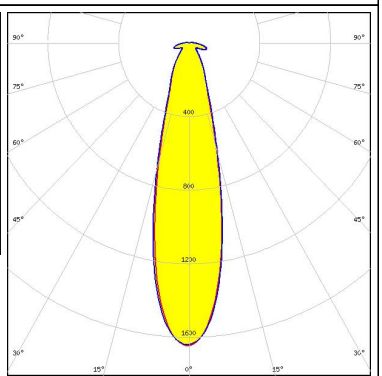
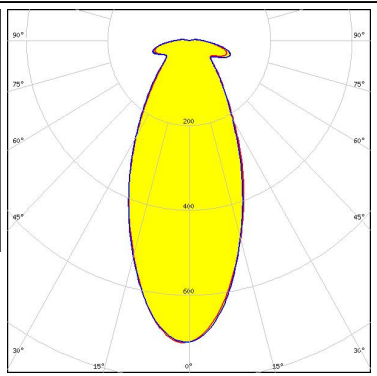

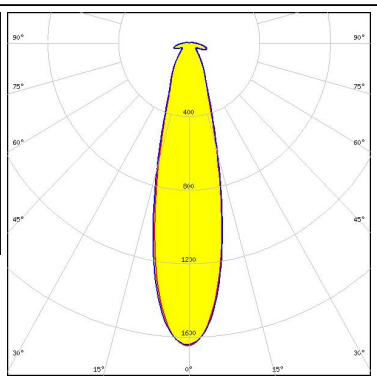
OPTICAL RESULTS (MEASURED):

<p></p> <p>LED V18 Gen7 FWHM / FWTM 32.0° / 77.0° Efficiency 85 % Peak intensity 1.2 cd/lm LEDs/each optic 1 Light colour White Required components: Bender Wirth: 439 Typ L3</p>		
<p></p> <p>LED V18 Gen7 FWHM / FWTM 32.0° / 77.0° Efficiency 84 % Peak intensity 1.2 cd/lm LEDs/each optic 1 Light colour White Required components: BJB: 47.319.2350</p>		
<p></p> <p>LED V22 Gen7 FWHM / FWTM 37.0° / 118.0° Efficiency 86 % Peak intensity 1 cd/lm LEDs/each optic 1 Light colour White Required components: TE Connectivity: 2213480-1</p>		
<p></p> <p>LED V22 Gen7 FWHM / FWTM 36.0° / 118.0° Efficiency 84 % Peak intensity 1 cd/lm LEDs/each optic 1 Light colour White Required components: Bender Wirth: 431 Typ Z1</p>		

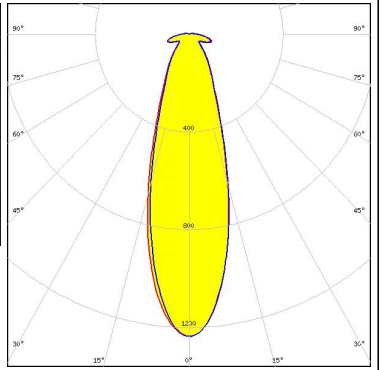

OPTICAL RESULTS (MEASURED):

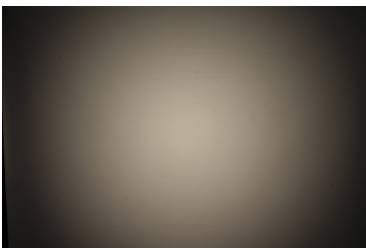
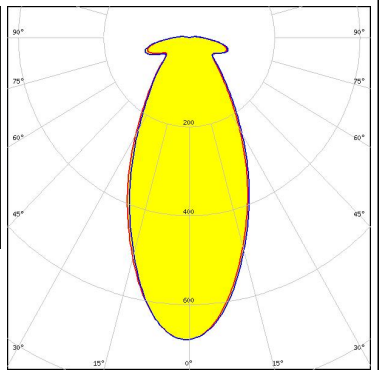
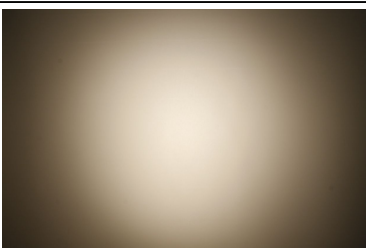
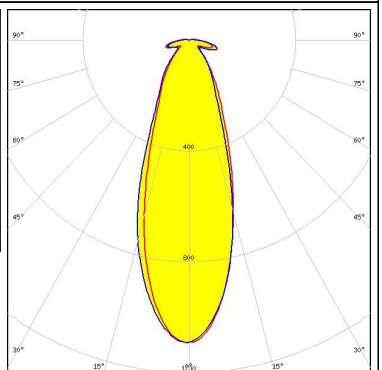
<p></p> <p>LED Vero SE 13</p> <p>FWHM / FWTM 27.0° / 63.0°</p> <p>Efficiency 85 %</p> <p>Peak intensity 1.6 cd/lm</p> <p>LEDs/each optic 1</p> <p>Light colour White</p> <p>Required components:</p>		
<p></p> <p>LED Vero SE 18</p> <p>FWHM / FWTM 31.0° / 73.0°</p> <p>Efficiency 86 %</p> <p>Peak intensity 1.3 cd/lm</p> <p>LEDs/each optic 1</p> <p>Light colour White</p> <p>Required components:</p>		
<p></p> <p>LED Vero SE 29</p> <p>FWHM / FWTM 46.0° / 161.0°</p> <p>Efficiency 87 %</p> <p>Peak intensity 0.7 cd/lm</p> <p>LEDs/each optic 1</p> <p>Light colour White</p> <p>Required components:</p>		
<p></p> <p>LED VERO13</p> <p>FWHM / FWTM 26.0° / 62.0°</p> <p>Efficiency 84 %</p> <p>Peak intensity 1.6 cd/lm</p> <p>LEDs/each optic 1</p> <p>Light colour White</p> <p>Required components:</p>		

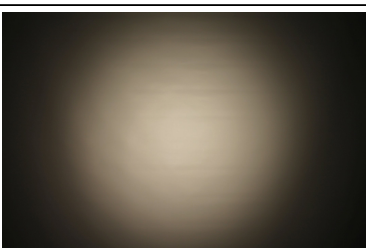
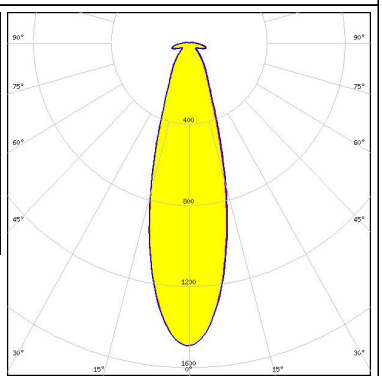

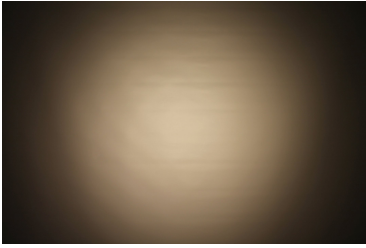
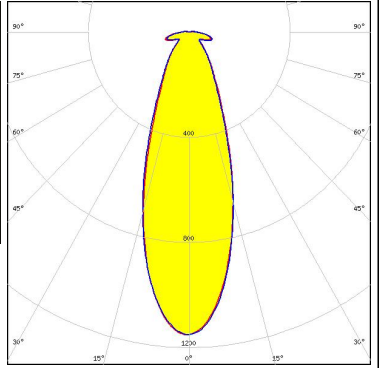
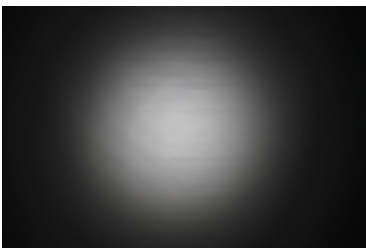
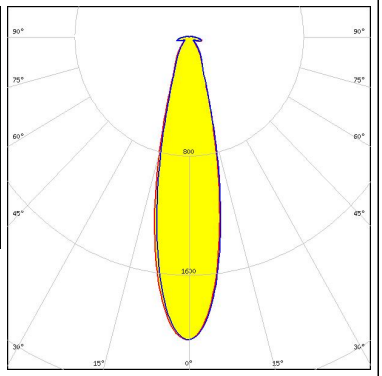

OPTICAL RESULTS (MEASURED):

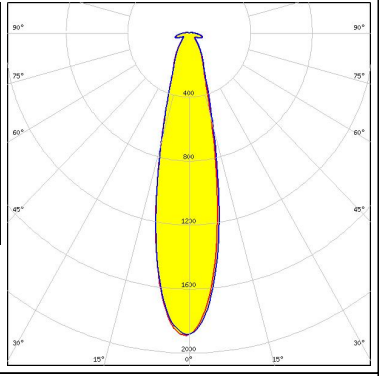
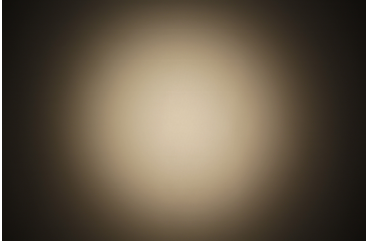
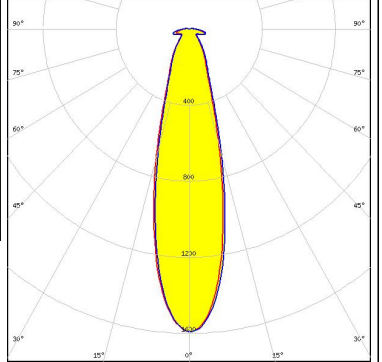
<p></p> <p>LED VERO18 FWHM / FWTM 31.0° / 75.0° Efficiency 85 % Peak intensity 1.2 cd/m LEDs/each optic 1 Light colour White Required components:</p>		
<p></p> <p>LED VERO29 FWHM / FWTM 48.0° / 165.0° Efficiency 87 % Peak intensity 0.7 cd/m LEDs/each optic 1 Light colour White Required components:</p>		
<p>CITIZEN</p> <p>LED CLL04x/CLU04x FWHM / FWTM 36.0° / 99.0° Efficiency 86 % Peak intensity 1.1 cd/m LEDs/each optic 1 Light colour White Required components:</p>		
<p></p> <p>LED CMA2550 FWHM / FWTM 30.0° / 67.0° Efficiency 86 % Peak intensity 1.5 cd/m LEDs/each optic 1 Light colour White Required components:</p>		

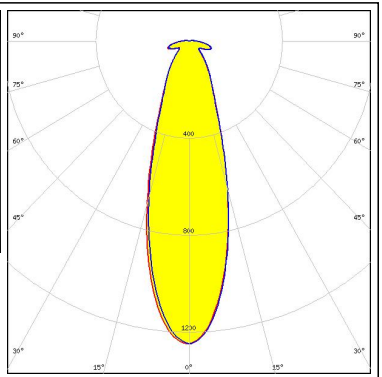

OPTICAL RESULTS (MEASURED):

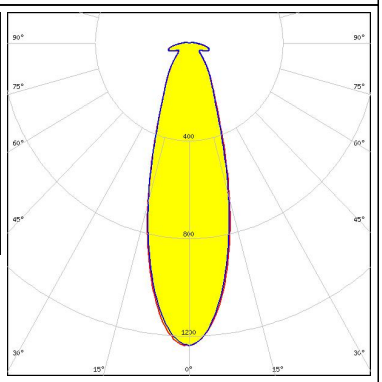
<p>CREE ⇄ LED</p> <p>LED CMA3090 FWHM / FWTM 35.0° / 79.0° Efficiency 88 % Peak intensity 1.2 cd/lm LEDs/each optic 1 Light colour White Required components:</p>		
<p>CREE ⇄ LED</p> <p>LED CMT19xx FWHM / FWTM 25.0° / 54.0° Efficiency 87 % Peak intensity 2 cd/lm LEDs/each optic 1 Light colour White Required components: Bender Wirth: 477 Typ Z1</p>		
<p>CREE ⇄ LED</p> <p>LED CXA/B 1816 & CXA/B 1820 & CXA 1850 FWHM / FWTM 24.0° / 57.0° Efficiency 84 % Peak intensity 1.9 cd/lm LEDs/each optic 1 Light colour White Required components:</p>		
<p>CREE ⇄ LED</p> <p>LED CXA/B 1830 FWHM / FWTM 26.0° / 64.0° Efficiency 85 % Peak intensity 1.6 cd/lm LEDs/each optic 1 Light colour White Required components: C14305_STELLA-CLAMP-CXA15-18</p>		

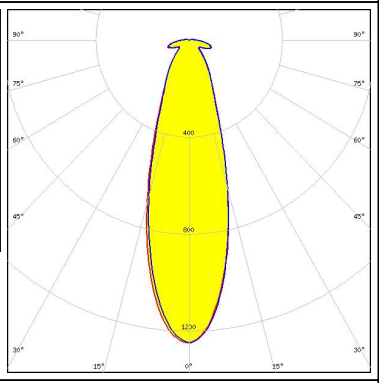
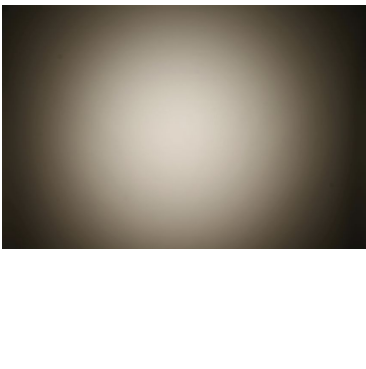
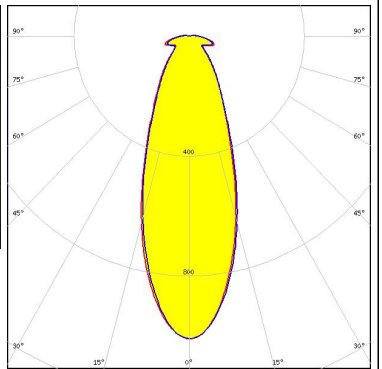



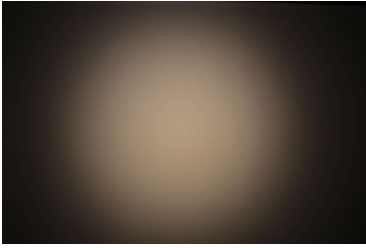
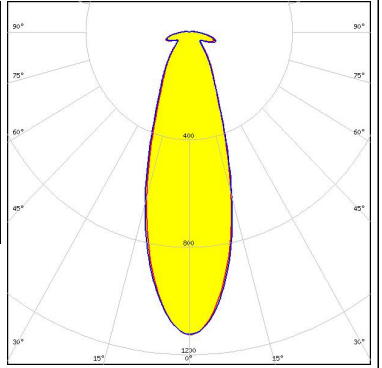

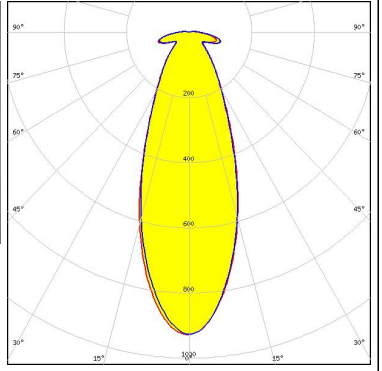
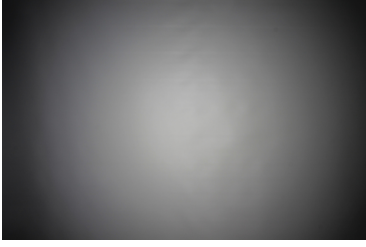
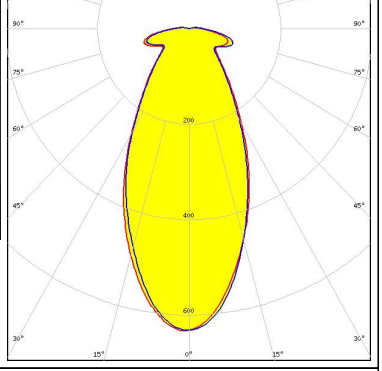
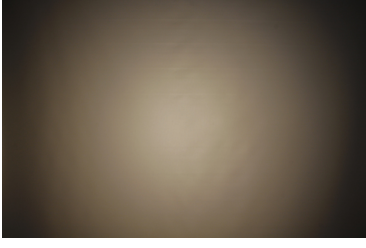
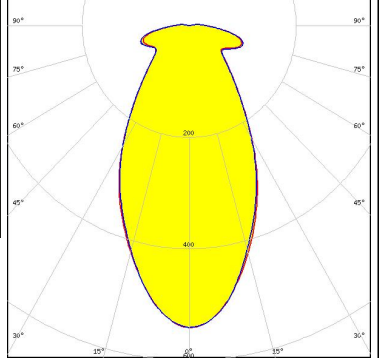
OPTICAL RESULTS (MEASURED):

<p>CREE → LED</p> <p>LED CXA/B 25xx FWHM / FWTM 31.0° / 75.0° Efficiency 86 % Peak intensity 1.2 cd/lm LEDs/each optic 1 Light colour White Required components:</p>		
<p>CREE → LED</p> <p>LED CXA/B 25xx FWHM / FWTM 32.0° / 76.0° Efficiency 85 % Peak intensity 1.2 cd/lm LEDs/each optic 1 Light colour White Required components: Bender Wirth: 439 Typ L3</p>		
<p>CREE → LED</p> <p>LED CXA/B 25xx FWHM / FWTM 33.0° / 120.0° Efficiency 84 % Peak intensity 1 cd/lm LEDs/each optic 1 Light colour White Required components:</p>		
<p>CREE → LED</p> <p>LED CXA/B 30xx FWHM / FWTM 37.0° / 87.0° Efficiency 88 % Peak intensity 1 cd/lm LEDs/each optic 1 Light colour White Required components: BJB: 47.319.2151</p>		

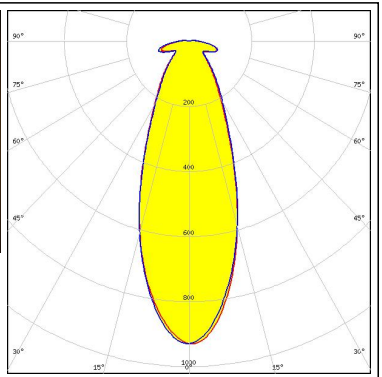
OPTICAL RESULTS (MEASURED):

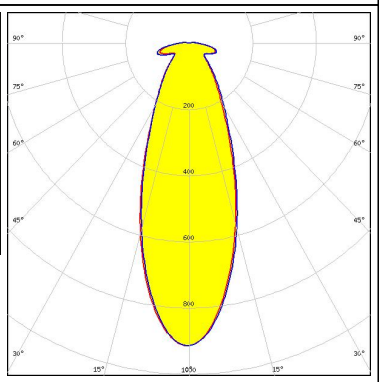
<p>LUMILEDS</p> <p>LED LUXEON CoB 1211</p> <p>FWHM / FWTM 33.0° / 79.0°</p> <p>Efficiency 85 %</p> <p>Peak intensity 1.1 cd/m</p> <p>LEDs/each optic 1</p> <p>Light colour White</p> <p>Required components: Bender Wirth: 431 Typ L3</p>		
<p>LUMILEDS</p> <p>LED LUXEON CoB 1213/1216/1812</p> <p>FWHM / FWTM 39.0° / 139.0°</p> <p>Efficiency 86 %</p> <p>Peak intensity 0.9 cd/m</p> <p>LEDs/each optic 1</p> <p>Light colour White</p> <p>Required components:</p>		
<p>LUMILEDS</p> <p>LED LUXEON CoB 1321</p> <p>FWHM / FWTM 50.0° / 165.0°</p> <p>Efficiency 85 %</p> <p>Peak intensity 0.6 cd/m</p> <p>LEDs/each optic 1</p> <p>Light colour White</p> <p>Required components:</p>		
<p>LUMILEDS</p> <p>LED LUXEON CoB 1825</p> <p>FWHM / FWTM 56.0° / 169.0°</p> <p>Efficiency 84 %</p> <p>Peak intensity 0.5 cd/m</p> <p>LEDs/each optic 1</p> <p>Light colour White</p> <p>Required components:</p>		

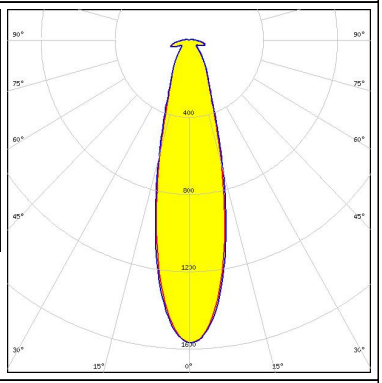
OPTICAL RESULTS (MEASURED):

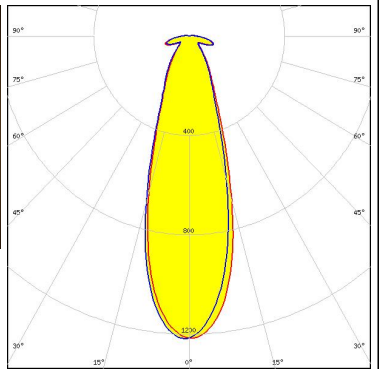
<p>LUMINUS</p> <p>LED CxM-22 (28x28)</p> <p>FWHM / FWTM 38.0° / 136.0°</p> <p>Efficiency 86 %</p> <p>Peak intensity 0.9 cd/lm</p> <p>LEDs/each optic 1</p> <p>Light colour White</p> <p>Required components: Bender Wirth: 431 Typ L3</p>		
<p>NICHIA</p> <p>LED COB H-Type</p> <p>FWHM / FWTM 38.0° / 120.0°</p> <p>Efficiency 85 %</p> <p>Peak intensity 0.9 cd/lm</p> <p>LEDs/each optic 1</p> <p>Light colour White</p> <p>Required components:</p>		
<p>NICHIA</p> <p>LED COB J-Type</p> <p>FWHM / FWTM 26.0° / 65.0°</p> <p>Efficiency 85 %</p> <p>Peak intensity 1.6 cd/lm</p> <p>LEDs/each optic 1</p> <p>Light colour White</p> <p>Required components:</p>		
<p>OSRAM Opto Semiconductors</p> <p>LED Soleriq S19</p> <p>FWHM / FWTM 32.1° / 72.5°</p> <p>Efficiency 84 %</p> <p>Peak intensity 1.2 cd/lm</p> <p>LEDs/each optic 1</p> <p>Light colour White</p> <p>Required components:</p>		

OPTICAL RESULTS (MEASURED):

PHILIPS

LED Fortimo SLM L06 CoB
 FWHM / FWTM 18.0° / 44.0°
 Efficiency 86 %
 Peak intensity 2.9 cd/lm
 LEDs/each optic 1
 Light colour White
 Required components:

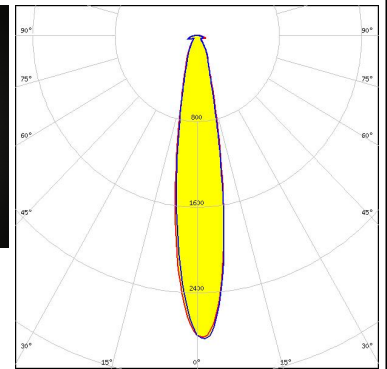

PHILIPS

LED Fortimo SLM L19 + SLM holder (PI)
 FWHM / FWTM 33.0° / 78.0°
 Efficiency 87 %
 Peak intensity 1.2 cd/lm
 LEDs/each optic 1
 Light colour White
 Required components:

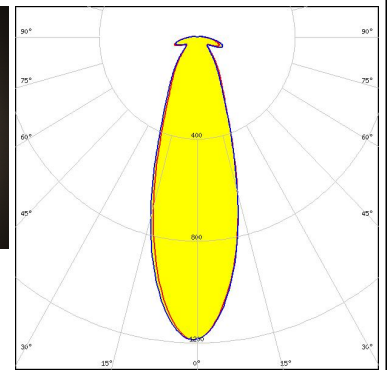
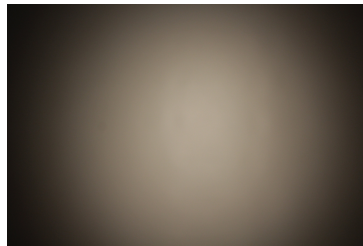

PHILIPS

LED Fortimo SLM L23 CoB
 FWHM / FWTM 38.0° / 87.0°
 Efficiency 87 %
 Peak intensity 1 cd/lm
 LEDs/each optic 1
 Light colour White
 Required components:

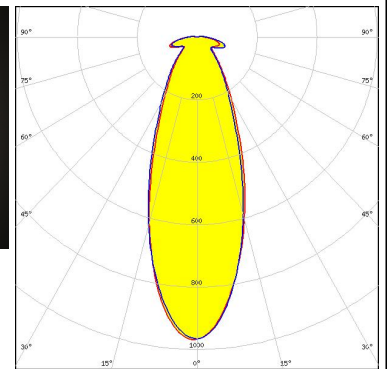
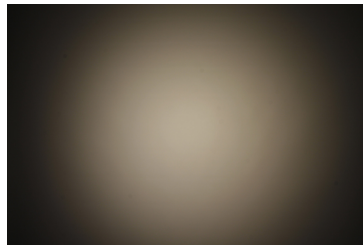

SAMSUNG

LED LC016D / LC019D / LC026D / LC033D
 FWHM / FWTM 27.0° / 65.0°
 Efficiency 83 %
 Peak intensity 1.5 cd/lm
 LEDs/each optic 1
 Light colour White
 Required components:

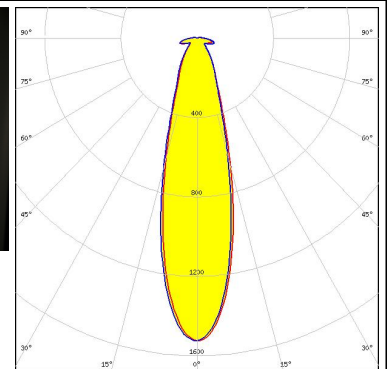
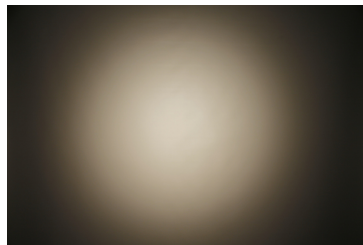

OPTICAL RESULTS (MEASURED):

SAMSUNG

LED LC040D / LC060D / LC080D
 FWHM / FWTM 37.0° / 119.0°
 Efficiency 84 %
 Peak intensity 0.9 cd/lm
 LEDs/each optic 1
 Light colour White
 Required components:

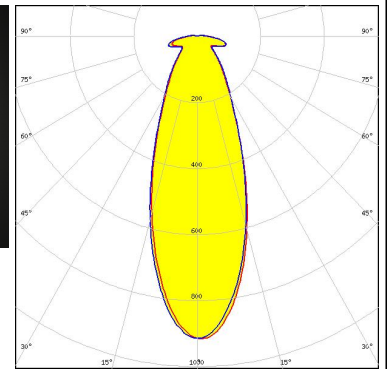
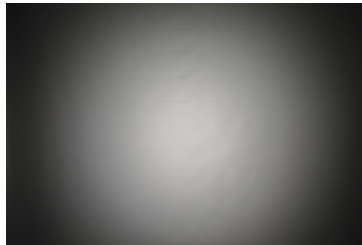

SEOUL SEMICONDUCTOR

LED MJT COB LES 14.5
 FWHM / FWTM 28.0° / 67.0°
 Efficiency 84 %
 Peak intensity 1.5 cd/lm
 LEDs/each optic 1
 Light colour White
 Required components:
 IDEAL: 50-2103CT

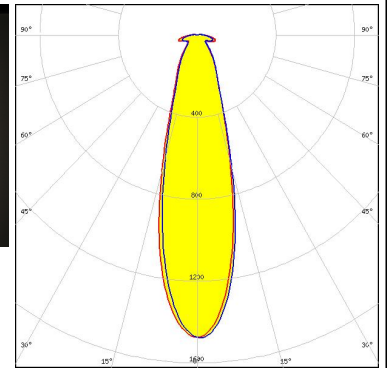
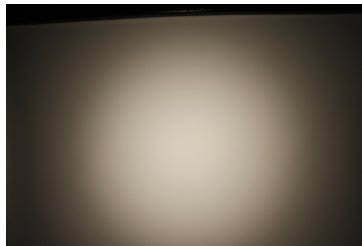

SEOUL SEMICONDUCTOR

LED MJT COB LES 22
 FWHM / FWTM 36.0° / 118.0°
 Efficiency 84 %
 Peak intensity 1 cd/lm
 LEDs/each optic 1
 Light colour White
 Required components:
 IDEAL: 50-2204CT

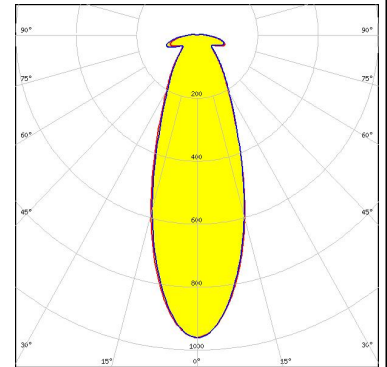

SEOUL SEMICONDUCTOR

LED MJT COB LES 22
 FWHM / FWTM 36.0° / 118.0°
 Efficiency 84 %
 Peak intensity 1 cd/lm
 LEDs/each optic 1
 Light colour White
 Required components:
 IDEAL: 50-2204CT

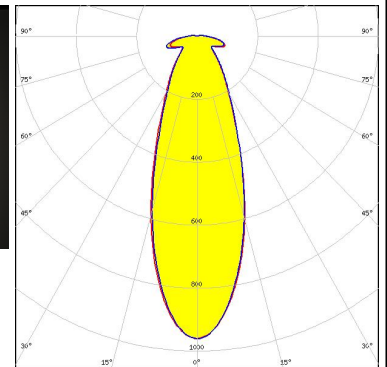
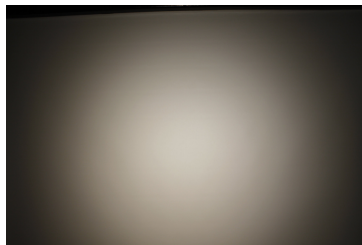

OPTICAL RESULTS (SIMULATED):

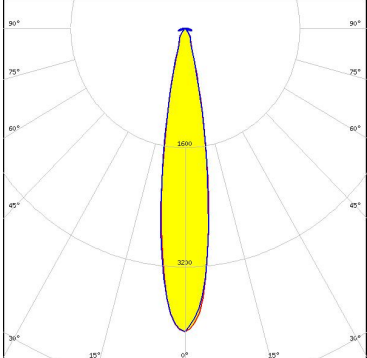
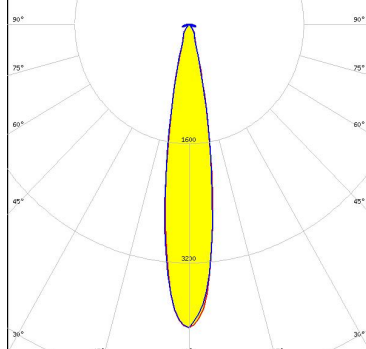
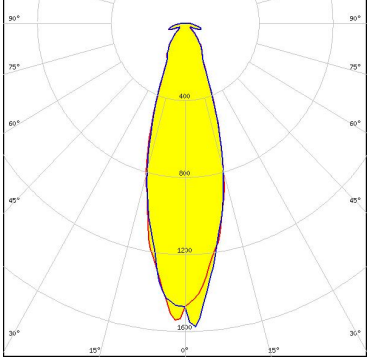
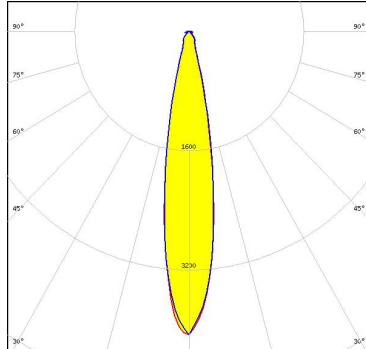
<p>bridgelux.</p> <p>LED V10 Gen7</p> <p>FWHM / FWTM 18.0° / 35.0°</p> <p>Efficiency 85 %</p> <p>Peak intensity 4 cd/lm</p> <p>LEDs/each optic 1</p> <p>Light colour White</p> <p>Required components: Bender Wirth: 486 Typ L1</p>	
<p>bridgelux.</p> <p>LED V13 Gen7</p> <p>FWHM / FWTM 20.0° / 90.0°</p> <p>Efficiency 86 %</p> <p>Peak intensity 0.4 cd/lm</p> <p>LEDs/each optic 1</p> <p>Light colour White</p> <p>Required components:</p>	
<p>bridgelux.</p> <p>LED V22 Gen7</p> <p>FWHM / FWTM 30.0° / 70.0°</p> <p>Efficiency 84 %</p> <p>Peak intensity 0.5 cd/lm</p> <p>LEDs/each optic 1</p> <p>Light colour White</p> <p>Required components: IDEAL: 50-2204CT</p>	
<p>CITIZEN</p> <p>LED CLL02x/CLU02x (LES10)</p> <p>FWHM / FWTM 17.0° / 35.0°</p> <p>Efficiency 86 %</p> <p>Peak intensity 4 cd/lm</p> <p>LEDs/each optic 1</p> <p>Light colour White</p> <p>Required components:</p>	

OPTICAL RESULTS (SIMULATED):

CITIZEN

LED CLL05x/CLU05x
 FWHM / FWTM 46.0° / 144.0°
 Efficiency 91 %
 Peak intensity 0.8 cd/lm
 LEDs/each optic 1
 Light colour White
 Required components:

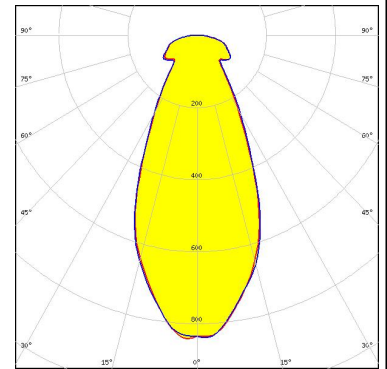

CREE LED

LED CMB3090
 FWHM / FWTM 34.0° / 74.0°
 Efficiency 85 %
 Peak intensity 1.3 cd/lm
 LEDs/each optic 1
 Light colour White
 Required components:

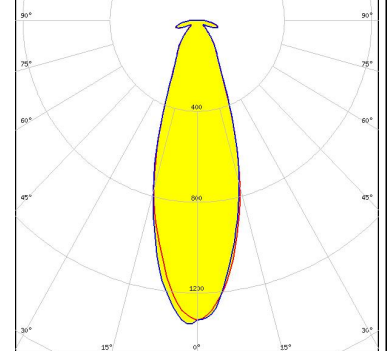

CREE LED

LED CXA/B 3590
 FWHM / FWTM 37.0° / 80.0°
 Efficiency 83 %
 Peak intensity 1.1 cd/lm
 LEDs/each optic 1
 Light colour White
 Required components:

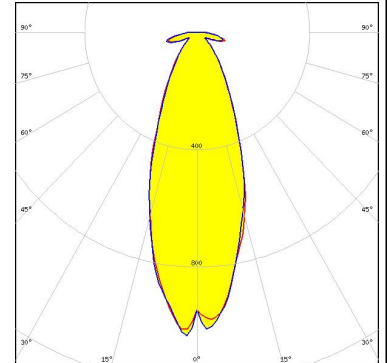

CREE LED

LED CXA/B 3590
 FWHM / FWTM 42.0° / 153.0°
 Efficiency 85 %
 Peak intensity 0.9 cd/lm
 LEDs/each optic 1
 Light colour White
 Required components:

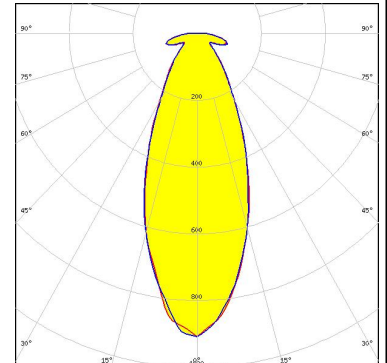

OPTICAL RESULTS (SIMULATED):

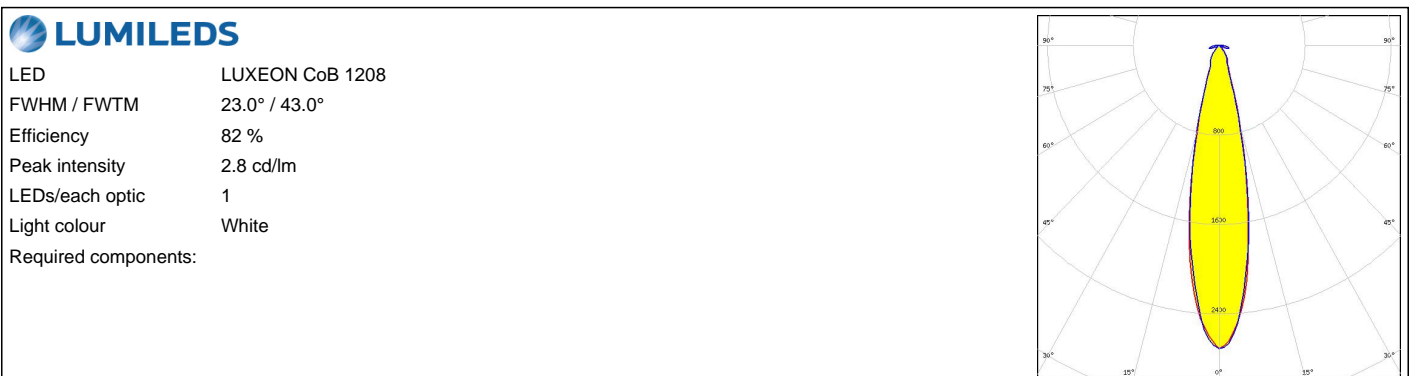
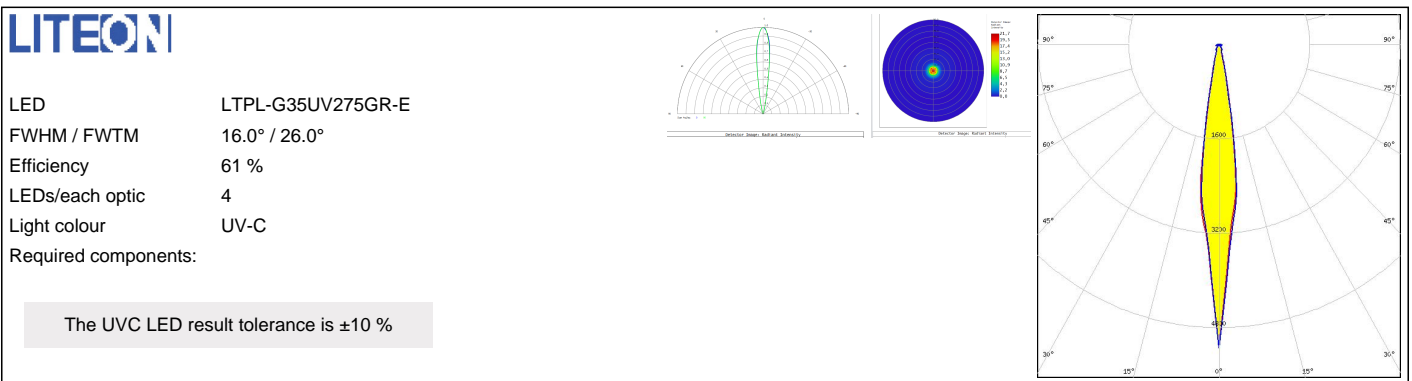
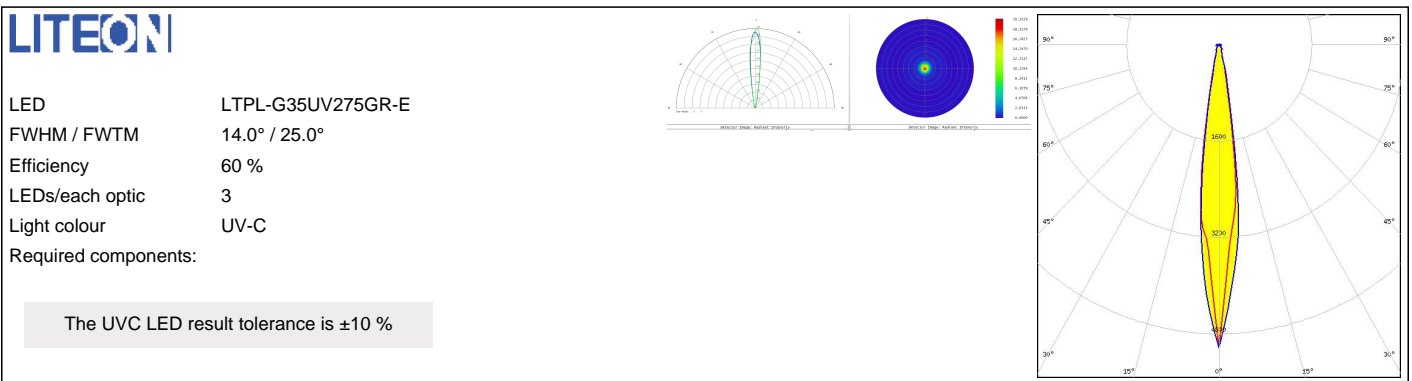
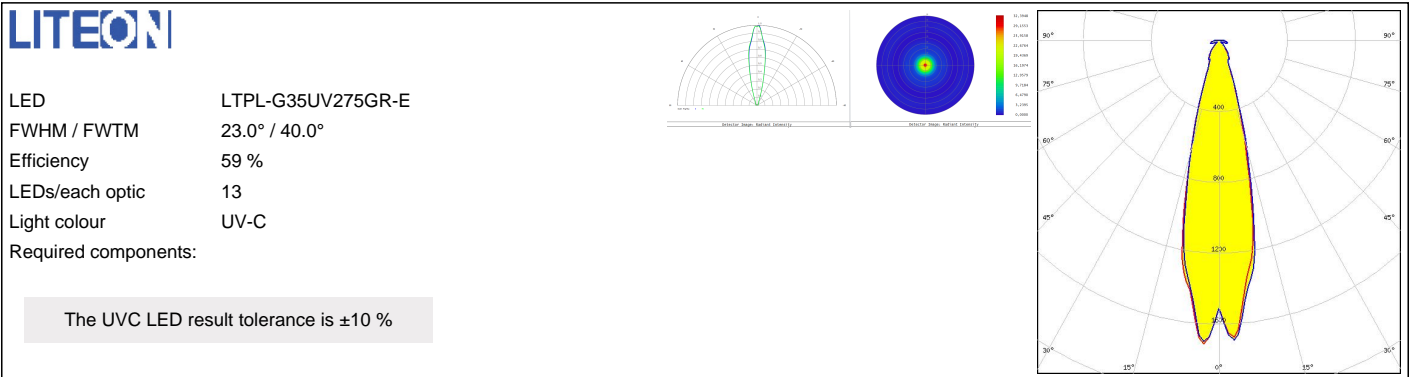

OPTICAL RESULTS (SIMULATED):

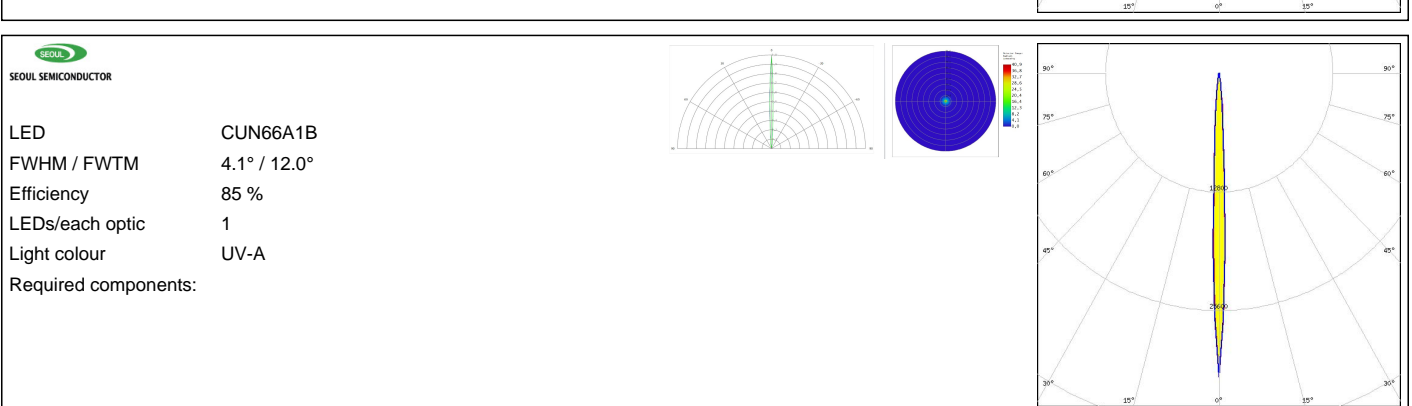
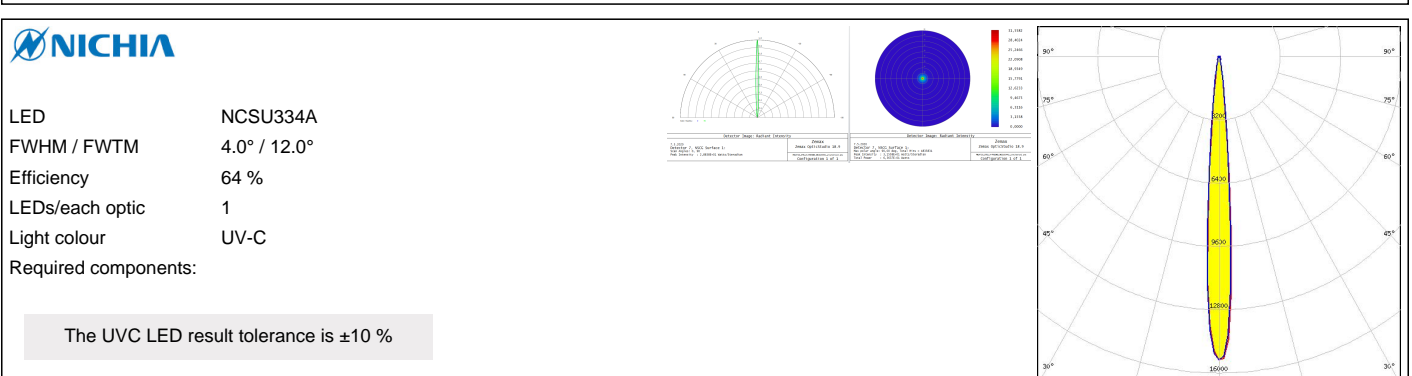
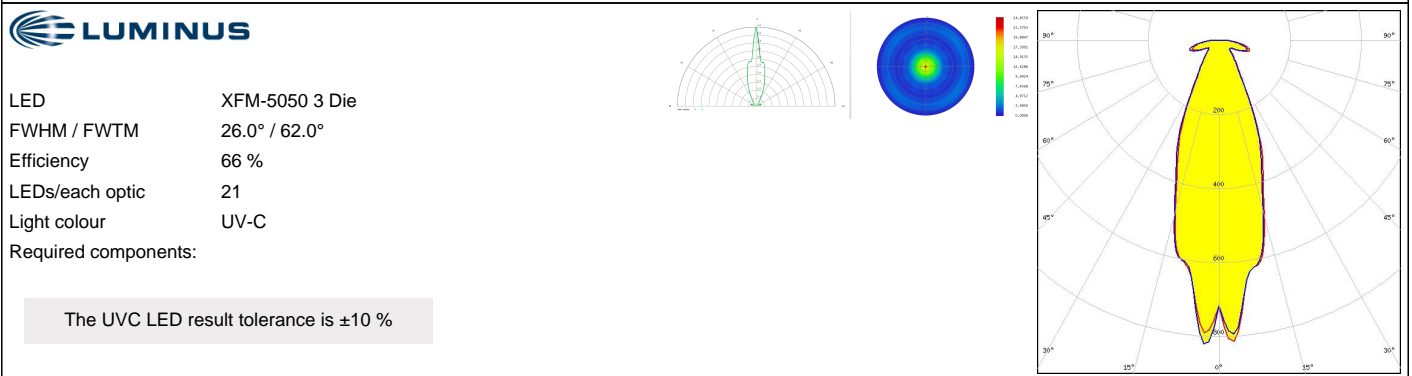

OPTICAL RESULTS (SIMULATED):

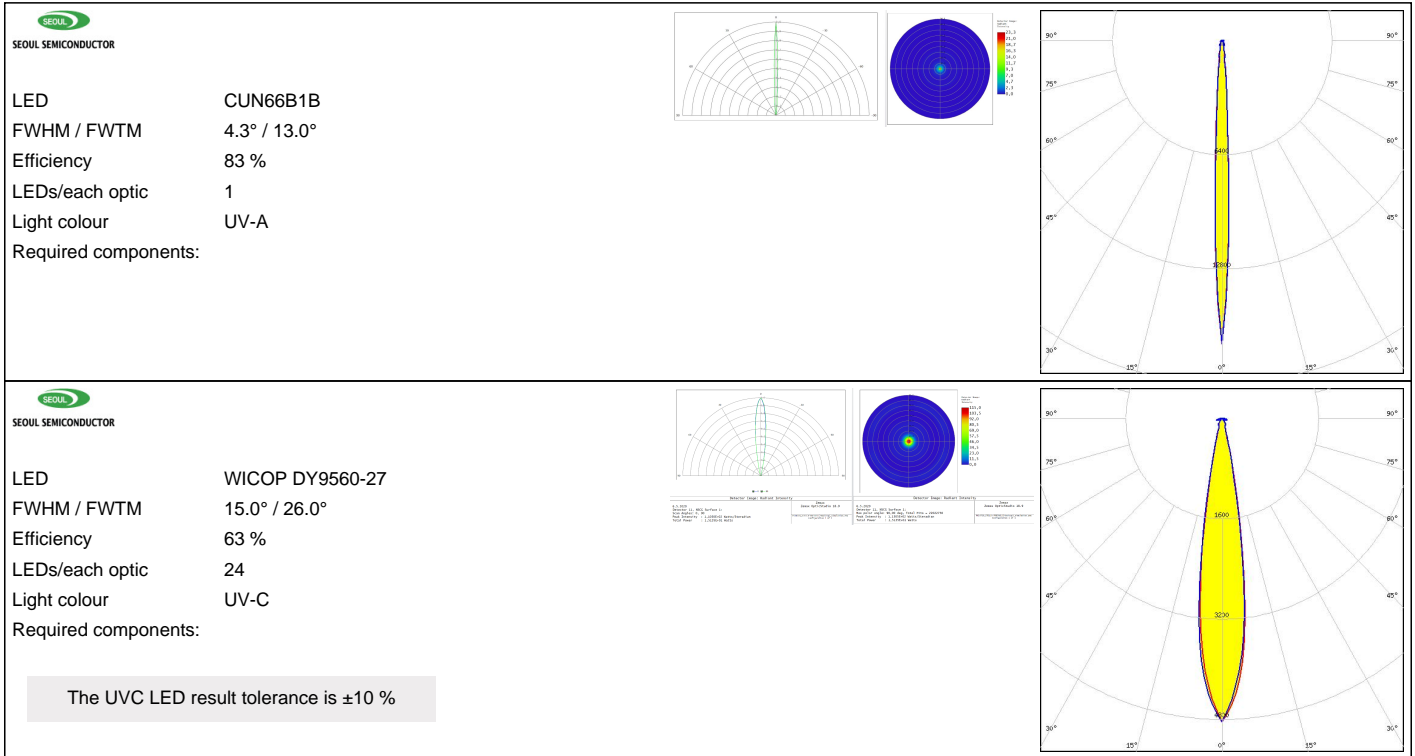

GENERAL INFORMATION:

NOTE: The typical beam angle will be changed by different color, chip size and chip position tolerance. The typical total beam angle is the full angle measured where the luminous intensity is half of the peak value.

Due to use of high power COB's with this product, special attention to proper thermal design is highly recommended. LEDiL has no liability for direct, indirect or consecutive damages arising from the LEDiL products being used outside of the recommended temperature range.

MATERIALS:

As part of our continuous research and improvement processes, and to ensure the best possible quality and availability of our products, LEDiL reserves the right to change material grades without notice.

PRODUCT DATA USER AGREEMENT AND DISCLAIMER:

The measured data in the provided downloadable LEDiL Product Datasheets and Mechanical 2D-Drawings is rounded and provided as reference for planning. LEDiL Oy's optical specifications have been verified by conducting performance testing of the products in accordance with the company's quality system. The reported data are averaged results of multiple measurements with typical variation. LEDiL Oy reserves the right to without prior notification make changes and improvements to its products.

LEDiL Oy assumes neither warranty, nor guarantee nor any other liability of any kind for the contents and correctness of the provided data. The provided data has been generated with highest diligence but the provided data may in reality not represent the complete possible variation range of all intrinsic parameters. Therefore, in certain cases a deviation from the provided data could occur.

LEDiL Oy reserves the right to undertake technical changes of its products without further notification which could lead to changes in the provided data. LEDiL Oy assumes no liability of any kind for the possible deviation from any provided data or any other damage resulting from the usage of the provided data.

The user agrees to this disclaimer and user agreement with the download or usage of the provided files.

LEDiL Oy

Joensuunkatu 13
FI-24240 SALO
Finland

LEDiL Inc.

228 West Page Street
Suite D
Sycamore IL 60178
USA

Ledil Optics Technology (Shenzhen) Co., Ltd.

405 , Block B
Casic Motor Building
Shenzhen 518057
P.R.CHINA

Local sales and technical support

[www.ledil.com/
where_to_buy](http://www.ledil.com/where_to_buy)

Shipping locations

Salo, Finland
Hong Kong, China

Distribution Partners

[www.ledil.com/
where_to_buy](http://www.ledil.com/where_to_buy)