

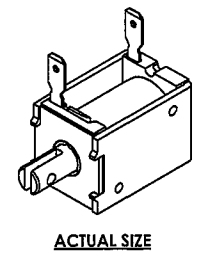

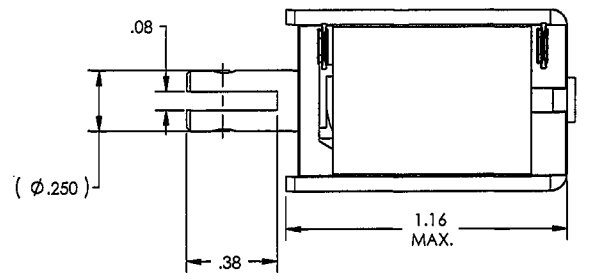

REVISIONS					
REV	BY	ECN	DESCRIPTION	DATE	APPD
A	RCH	04-018	RELEASE FOR PRODUCTION	8/20/04	RCH
B	RCH	05-032	135.0 WAS 144.0	3/09/06	RCH
C	RCH	15-002	ADD F0415A AND F0416A	1/29/15	RCH

PART NO.	DESCRIPTION	OHMS ± 10% @ 25°C	DIGI-KEY NO.
F0411A	L-22PL012D-C	36.0	527-1000-ND
F0412A	L-22PL012D-I	16.9	527-1001-ND
F0413A	L-22PL024D-C	135.0	527-1002-ND
F0414A	L-22PL024D-I	68.0	527-1003-ND
F0415A	L-22PL012D-P	3.6	TBD
F0416A	L-22PL024D-P	14.0	TBD

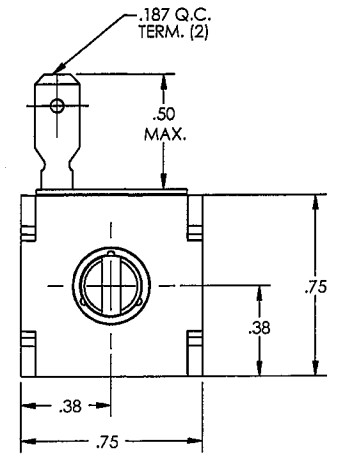
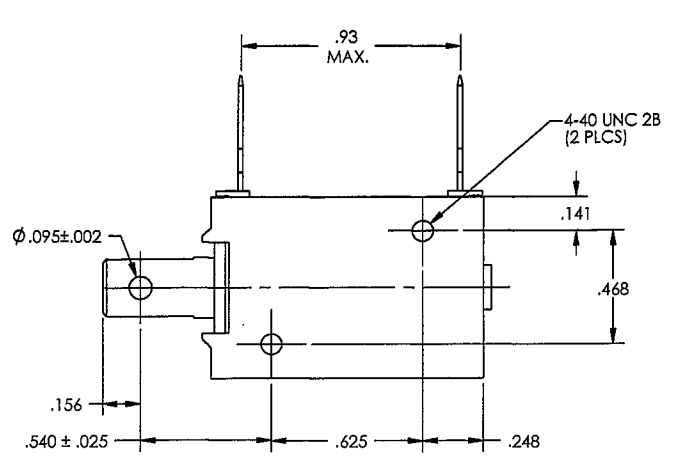

LABEL INFO:
 PONTIAC COIL, INC.
 (PART NO.) (DATECODE)
 (DESCRIPTION)

UNLESS OTHERWISE SPECIFIED ALL DIMENSIONS ARE IN INCHES DIMENSIONS IN [] ARE MILLIMETERS TOLERANCES: X [] ± .1 XX [] ± .01 XXX [] ± .005 XXXX [] ± .0005 FRACTIONS ± 1/32 ANGLES IN DEGREES ± 2°	MATL: SEE BOM PRINTS FINISH PLATING: SEE BOM PRINTS INDY ASSY: THIS DOCUMENT IS THE PROPERTY OF PONTIAC COIL, INC. AND ALL CONTENTS ARE PROPRIETARY  ANSI Y14.5M-1992	 PONTIAC COIL, INC. TITLE: CUSTOMER DRAWING L22 FILE NAME: CD-F041XA.SLDDRW SIZE: B DWG NO: CD-F041XA CUSTOMER: DIGI-KEY CUSTOMER P/N: SCALE: 2=1 AMCCODE: SHEET 1 OF 1 FULL FILE NAME: E:\DWG\SPCS\CD-F041XA.SLDDRW
--	--	--