

CIRCUIT	PART NO.	DIM A	COLOR
2	171692-0202	8.35	BLACK
4	171692-0204	12.05	
6	171692-0206	17.75	
8	171692-0208	23.45	
10	171692-0210	29.15	
12	171692-0212	34.85	

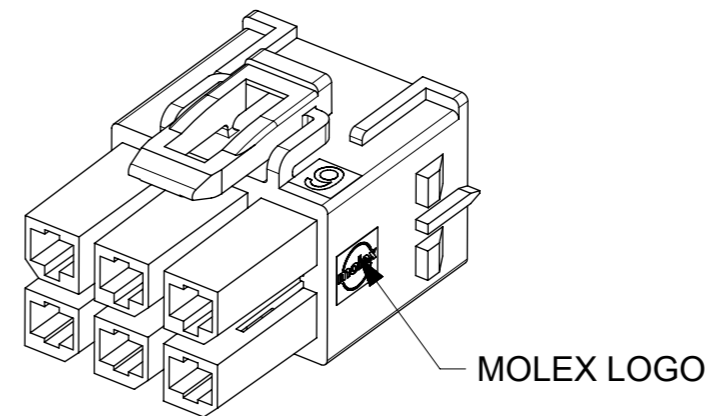

NOTES:

- MATERIAL:**
 NYLON, UL 94V-0 AND GLOW WIRE CAPABLE PER IEC60335-1.
 COLOR: BLACK.
- PART USED WITH MOLEX SERIES:**
 HEADER: 76829, 172065; 76825, 172064
 PLUG: 105411
 TPA-CAPABLE FEMALE TERMINAL: 76823, 172063
 TPA: 105415
- PRODUCT SPECIFICATION:** 1054171000-PS/1720631000-PS.
- PAKAGING SPECIFICATION:** 1716920200.
- APPLICATION SPECIFICATION:** 768232000-AS

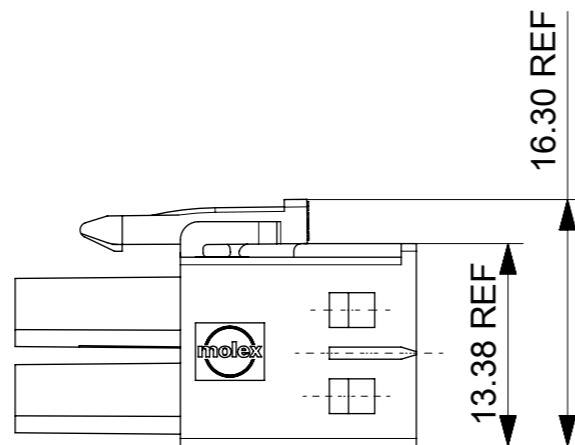
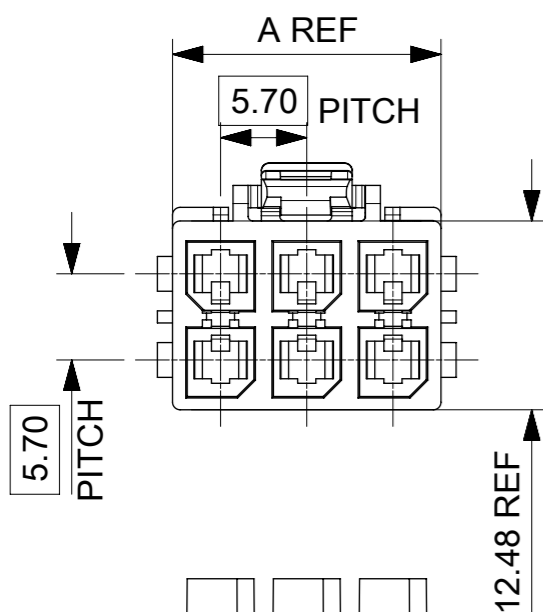
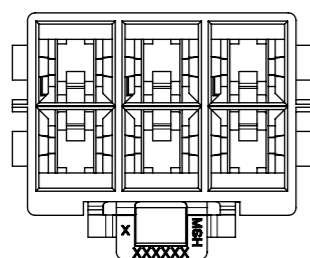
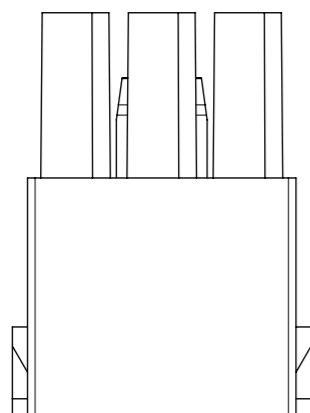

THIS DRAWING CONTAINS INFORMATION THAT IS PROPRIETARY TO MOLEX ELECTRONIC TECHNOLOGIES, LLC AND SHOULD NOT BE USED WITHOUT WRITTEN PERMISSION									
DIMENSION UNITS		SCALE		CURRENT REV DESC:				molex	
mm		NTS							
GENERAL TOLERANCES (UNLESS SPECIFIED)				EC NO: 704917				MEGA-FIT RECEPTACLE DR TPA	
ANGULAR TOL ± 3.0°				DRWN: XQZHANG 2022/04/28					
4 PLACES ±				CHK'D: XQZHANG 2022/04/28				PRODUCT CUSTOMER DRAWING	
3 PLACES ±				APPR: XQZHANG 2022/04/28					
2 PLACES ± 0.25				INITIAL REVISION:				DOCUMENT NUMBER	
1 PLACE ± 0.35				DRWN: YXZHENG 2016/12/15				1716920200	
0 PLACES ±				APPR: YXZHENG 2018/08/06				DOC TYPE DOC PART REVISION	
DRAFT WHERE APPLICABLE MUST REMAIN WITHIN DIMENSIONS				THIRD ANGLE PROJECTION		DRAWING		SHEET NUMBER	
				A3-SIZE		SERIES		1 OF 2	
				171692		MATERIAL NUMBER		GENERAL MARKET	
				SEE TABLE		CUSTOMER			

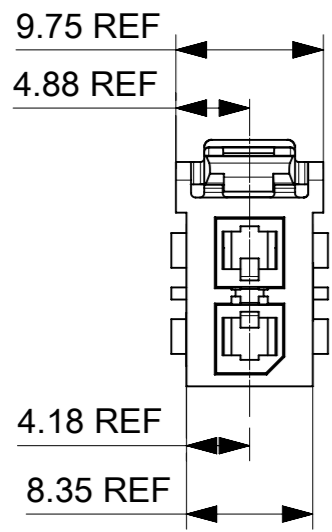

2 CKT

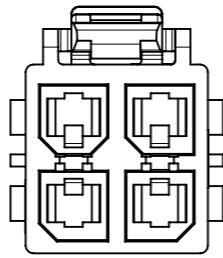
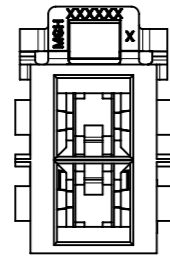

4 CKT

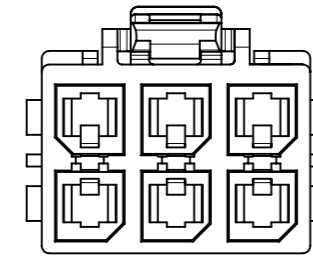
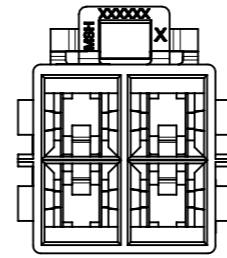

6 CKT

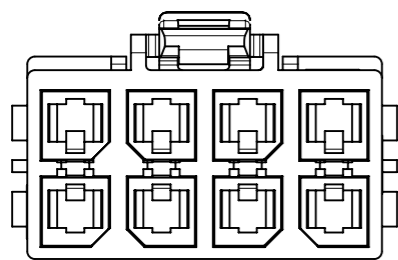
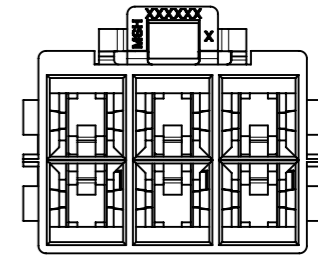

8 CKT

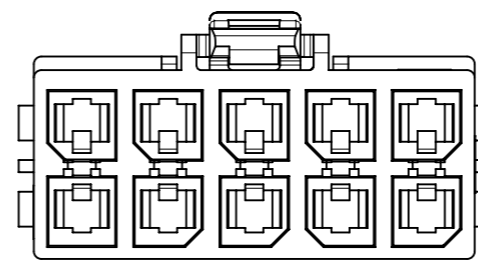
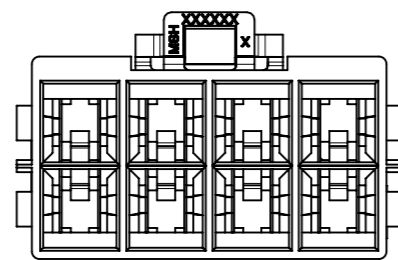

10 CKT

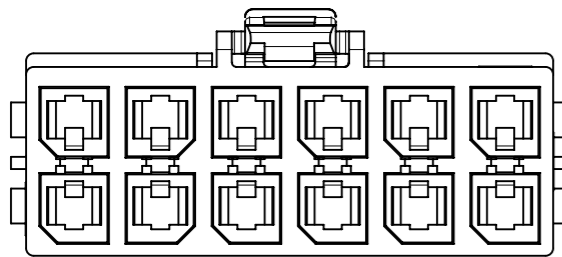
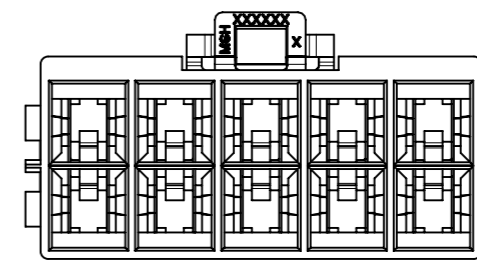

12 CKT

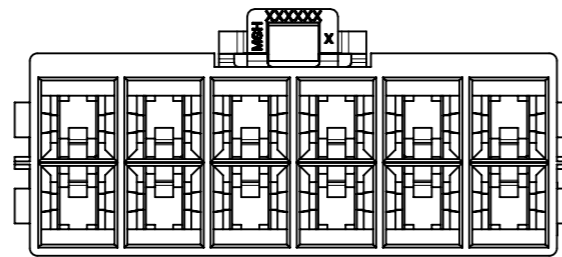

THIS DRAWING CONTAINS INFORMATION THAT IS PROPRIETARY TO MOLEX ELECTRONIC TECHNOLOGIES, LLC AND SHOULD NOT BE USED WITHOUT WRITTEN PERMISSION										
DIMENSION UNITS	SCALE	CURRENT REV DESC:					molex			
mm	NTS									
GENERAL TOLERANCES (UNLESS SPECIFIED)		EC NO: 704917					MEGA-FIT RECEPTACLE DR TPA			
ANGULAR TOL ± 3.0 °		DRWN: XQZHANG 2022/04/28								
4 PLACES	±	CHK'D: XQZHANG 2022/04/28					PRODUCT CUSTOMER DRAWING			
3 PLACES	±	APPR: XQZHANG 2022/04/28								
2 PLACES	± 0.25	INITIAL REVISION:					DOCUMENT NUMBER	DOC TYPE	DOC PART	REVISION
1 PLACE	± 0.35	DRWN: YXZHENG 2016/12/15					1716920200	PSD	000	E1
0 PLACES	±	APPR: YXZHENG 2018/08/06								
DRAFT WHERE APPLICABLE MUST REMAIN WITHIN DIMENSIONS		THIRD ANGLE PROJECTION	DRAWING	SERIES	MATERIAL NUMBER	CUSTOMER		SHEET NUMBER		
			A3-SIZE	171692	SEE TABLE	GENERAL MARKET		2 OF 2		