

Rotary Cam Switches – 20A to 350A



Data according to UL and cUL

Type		M10 P	M10H	M10HD	M20	N20	N33F	N61	N80	N100	N200	L400
Rated voltage	V~	300	600	600	600	600	600	600	600	600	600	600
Rated operational current "General Use" A with jumper A	A	20	20	5	35	35	60	90	115/125 ³⁾	130	250	350
	A	15	-	-	25	25	40	80	80/125 ³⁾	-	-	-
DOL-Rating 3-phase	110-120V	hp	1½	1½	-	5	5	7½	8½	10	15	15
	200-208V	hp	2	2	-	5	5	10	12½	15	25	25
	220-240V	hp	3	3	-	5	5	15	17	20	30	30
	440-480V	hp	-	5	-	10	10	25	35	40	40	60
	550-600V	hp	-	7½	-	15	15	30	40	50	50	75
DOL-Rating 1-phase	110-120V	hp	½	½	-	1½	1½	3	4	5	7½	7½
	200-208V	hp	1	1	-	3	3	5	6½	7½	15	15
	220-240V	hp	1½	1½	-	5	5	7½	8	10	15	20
Fuse size (RK5) Man. Motor Controller 5kA / 600V and Motor Disconnect	A	40 ²⁾	40	-	80	80	150	150	200	300	350	350
Heavy pilot duty	AC	A300	A600	B600	A600	A600	A600	A600	A600	A600	A600	A600
Cable cross sections	solid	AWG	12 - 20	12 - 20	12 - 20	10 - 18	10 - 18	10 - 12	10 - 12	10 - 12	10 - 14	-
	flexible	AWG	14 - 20	14 - 20	14 - 20	8 - 18	8 - 18	6 - 12	2 - 12	2/1 ³⁾ - 12	1 - 14	250kcmil
Tightening torque	Nm	1-1.2	1-1.4	1-1.4	1.7-1.8	1.7-1.8	1.2-1.8	2.8	2.8	4.5	23	40
	lb.inch	9-11	9-13	9-13	15-16	15-16	11-16	25	25	40	202	352

1) Maximum cable cross-section with prepared conductor

2) 5kA / 300V



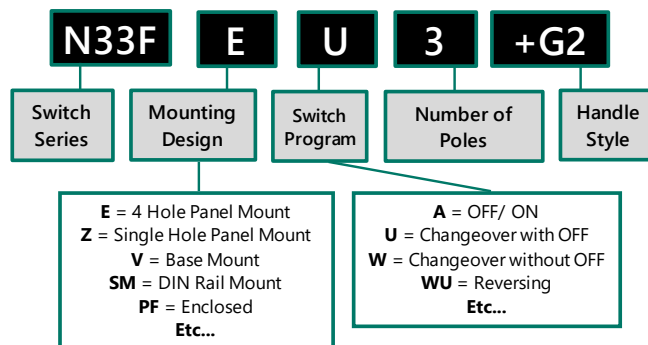

3) Increased rated operational current 125A "General Use" and "with jumper" with AWG 1. Add suffix + WK.

Ordering Code Example:

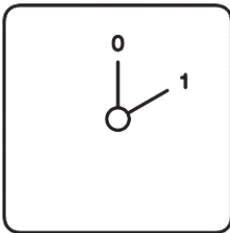

Rotary Cam Switches – 20A to 350A

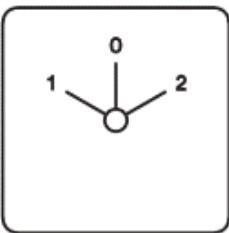
Basic Switching Programs

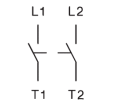
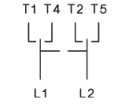
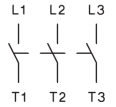
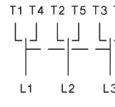
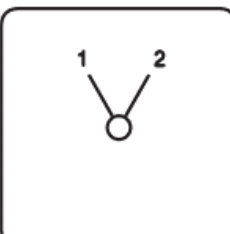
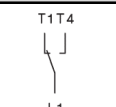
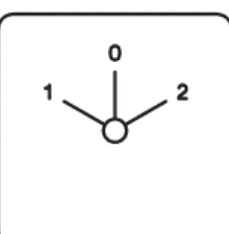
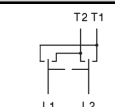
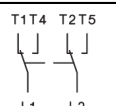
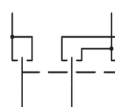
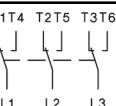
OFF / ON Switches	Ordering Code*	Description	Diagram	Changeover Switches (With OFF)	Ordering Code*	Description	Diagram
 <p>60° switching angle</p>	A1	1 Pole		 <p>60° switching angle</p>	U1	1 Pole	
	A2	2 Pole			U2	2 Pole	
	A3	3 Pole			U3	3 Pole	
Changeover Switches (Without OFF)	Ordering Code*	Description	Diagram	Reversing Switches	Ordering Code*	Description	Diagram
 <p>60° switching angle</p>	W1	1 Pole		 <p>60° switching angle</p>	WU2	2 Pole	
	W2	2 Pole			WU3	3 Pole	
	W3	3 Pole					

*Please refer to our full catalog for in depth listing of switch programs, as customized cam switch options are endless.

Additional Customizations Available:

- Custom Designed Switch Programs
- Custom Engraved Legend Plates
- Padlock Device (Handle)
- Keylock Device (Handle)
- Moisture Proofing & Dust Covers
- Custom Switching Angles
- Door Coupling Mechanism
- Angled Terminals
- Fast-on Connectors
- And more...

