

USER MANUAL

Triple Output Programmable DC Power Supply Model IT6302



© Copyright belongs to ITECH Co. Ltd.
Ver2.4/Sep. 2019/ IT6300-508

Security regulation	3
Safety symbols	3
Certification and Quality Assurance.....	3
Introduction.....	4
Chapter 1 Quick Reference.....	5
1.1 The front panel and rear panel description.....	5
1.1.1 Front panel.....	5
1.1.2 The Rear Panel.....	6
1.1.3 Dimensions.....	7
1.2 Preliminary Checkout.....	8
1.2.1 Check the list of supplied items.....	8
1.2.2 Power on Pre-check.....	8
1.2.3 Checkout procedure.....	9
1.2.4 Output verification.....	10
1.2.5 If the power supply does not turn on.....	10
1.2.6 How to exchange the fuse.....	11
1.2.7 Adjust the carrying handle.....	11
Chapter 2 Specification.....	12
2.1 Specification.....	12
2.2 Additional features.....	13
Chapter 3 Front-panel Operation	14
3.1 Front-panel Operation Overview	14
3.2 Panel Description	15
3.3 VFD Description	16
3.4 Menu Description.....	17
3.5 Panel Operation	17
3.5.1 Channel Operation.....	17
3.5.2 OUT ON/OFF.....	17
3.5.3 Set Voltage.....	18
3.5.4 Current Operation	18
3.5.5 Save and Recall Operation.....	19
3.5.6 LVP operation	19
3.5.7 Key Lock Set.....	19
3.5.8 Protections	20
3.6 Menu Description.....	20
4.1 Communication module introduction	26
4.1.1 IT-E121 communication module	26
4.1.2 IT-E122 communication module	26
4.2 Communication between power supply and PC	27

IT6302 DC programmable power supply

About your safety

Please do not install replacement parts in the instrument, or perform any unauthorized modification. Please send the instrument to our company's maintenance department for maintenance, to ensure its security features.

Please refer to the manual for specific information warning or precautions to avoid personal injury or equipment damage.

There is no part that the operators can maintenance. If maintenance service is required, please contact trained service personnel.

Security regulation

To prevent electric shock, a non-authorized personnel is strictly not allowed to open the machine.

This equipment is strictly prohibited for use in life support systems or any other device with security requirements.

We can't accept responsibility for any direct or indirect financial damage or loss of profit that might occur when using the electronic load.

Safety symbols

Warning

It reminds the user, note some operating procedures, practices, conditions and other matters that may lead to human casualties.

Notes:

It reminds the user of some operating procedures, practices, conditions and other matters that may result in instrument damage or data lose forever.



Connect it to safety earth ground using the wire recommended in the user manual.



The symbol on an instrument indicates that the user should refer to the operating instructions located in the manual.



High voltage danger

Certification and Quality Assurance

IT6302 programmable DC power supply fully meets all of the technical specification in the manual.

Warranty

Our Company gives one year warranty for the materials and manufacturing of the product since the date of shipment.

Warranty Service

For the warranty service or repair the product, the product must be returned to the designated maintenance units. Return the product to us for warranty service, the customer should pre-pay the one-way Freight to the maintenance department, and our company is responsible for the return shipping cost.

If products are returned from other countries for maintenance service, then the customer should pay all freight, duties and other taxes.

Guarantee limit

The guarantee does not apply to the damage caused by the following conditions:

Improper or inadequate maintenance to the products by customer;

Customers use their own software or interface;

Unauthorized modification or misuse;

Operate this product not in the specified environment, or at the wrong place configuration and maintenance;

Damage from Customer self-installation of circuit, or defects due to customers use their products;

Product model or serial number of the fuselage has been altered, deleted, removed or made illegible;

Damage caused by accidents including but not limited to lightning, water, fire, abuse or neglect.

Notice

If the content of this manual is subject to change, we will not notice additionally

Introduction

IT6302 triple output programmable DC power supply, the output voltage or current of each channel can be set from 0 to max rated value.

The triple output power supply provides you with high-resolution, high accuracy and high stability, and supports over voltage, over temperature protection; Provides a serial or parallel mode, used to extend the voltage or current output capacity. Resolution reaches up to 10mV/1mA that it can meet the needs of a variety of applications, and is a great choice for University or R & D department and the manufacturer. The main features and advantages are as follows:

- Triple output voltage, all are adjustable. CH1, CH2 adjust range: 0~30V, CH3 adjust range :0~5V, current range : 0~3A
- CH1 and CH2 can set to serial/parallel/track mode, series to max 60V, parallel to max

6A.

- The voltage and current for the three channels can be displayed at the same time
- Small size of 1/2 2U
- VFD display
- Function keys with LED light
- High accuracy, resolution and stability
- Switch to control the output status
- Limited voltage and over heat protection
- Intelligent fan control, energy conservation, noise reduction
- Support RS232/USB communication interface, IT-E121 is for RS232 communication, IT-E122 for USB communication*
- Low ripple and low noise
- Shut off memory function
- Can be monitored by computer software
- Memory capacity of 27 groups, for save and recall
- Can adjust the voltage or current by knob
- Can adjust the stepping by Left/right arrow button

*IT-E121 and IT-E122 are optional accessories, not standard accessories.

Chapter 1 Quick Reference

1.1 The front panel and rear panel description

1.1.1 Front panel

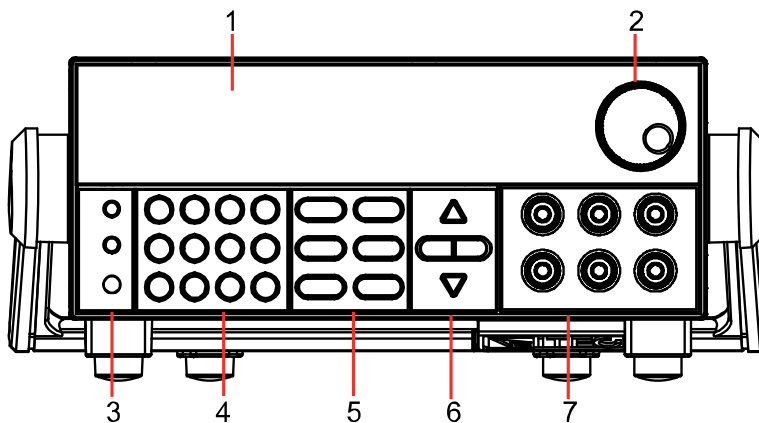

Picture 1

1 VFD display

- 2** Rotary knob
- 3** Power switch, Local and Shift key
- 4** Numeric keys and ESC escape key
- 5** Function keys
- 6** Up/Down/Left/Right keys
- 7** Output terminal

VFD display description

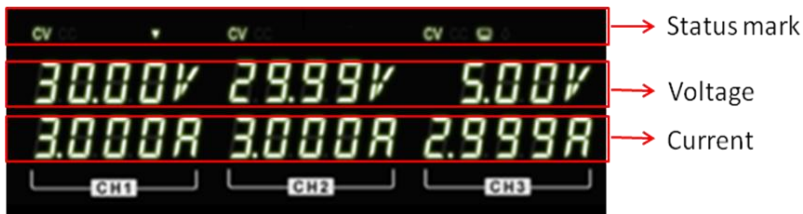

The status flags will be described in chapter 3.3.

Output terminal

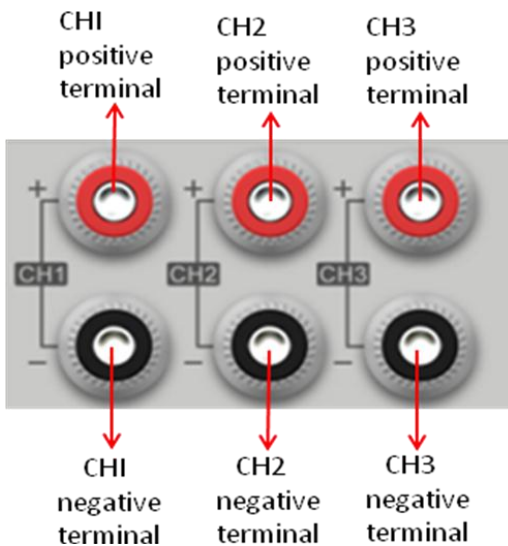

Note: If the power supply is used to charge the battery, you should pay attention to the positive and negative polarity; otherwise you may burn the power supply!

1.1.2 The Rear Panel

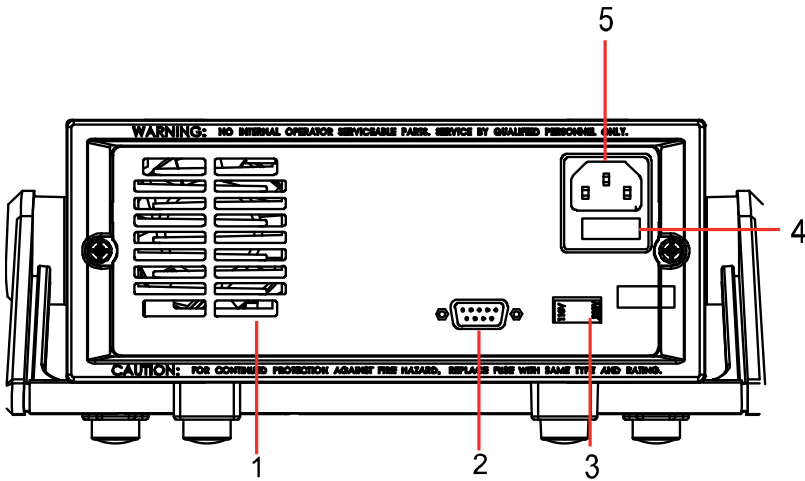

Picture 2

- 1** Ventilation holes
- 2** TTL
- 3** 110V/220V AC power selection switch
- 4** Fuse
- 5** AC power inlet

1.1.3 Dimensions

The dimension of IT6302 power supply:

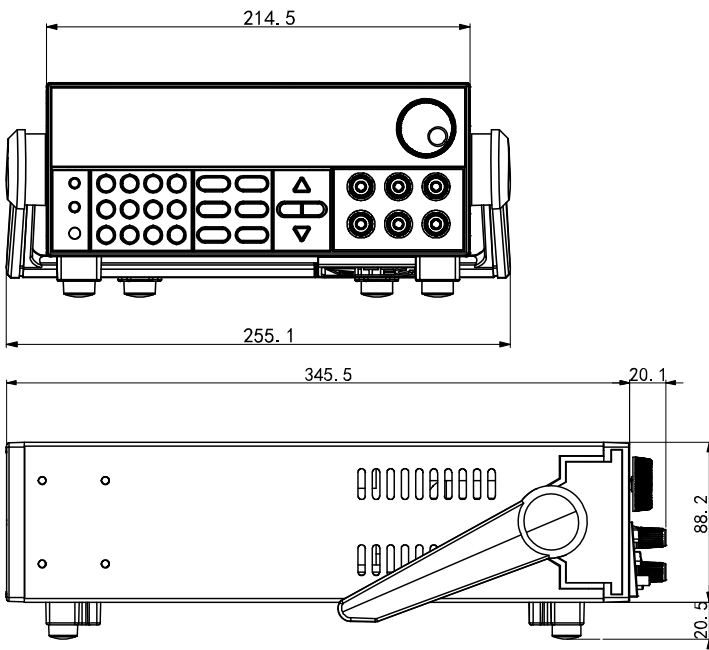

Unit: millimeter (mm)

1.2 Preliminary Checkout

The following steps help you verify that the power supply is ready for use.

1.2.1 Check the list of supplied items

Verify that you have received the following items with your power supply, if anything is missing, contact your authorized supplier.

1. Power cord
2. User manual
3. Calibration report
4. Certificate

1.2.2 Power on Pre-check

Before operation the power supply, please read the following safety guide:



Warning: The AC input voltage is 110V or 220V; please check the switching at the bottom of the power supply, to make sure it matches the voltage in your city. Otherwise, the power supply may be damaged.



Warning: The power supply provides a three-wire power cord; you should plug it to a three cord junction box. You should also make sure the power supply is well grounded.



Warning: The connection wire should have enough current capacity that it can bear the max rated current/short current of the power supply and not get too hot.



Warning: To avoid any fire or electric shock, please ensure the AC input voltage fluctuation not exceed 10% of the working voltage range.

Note: In some situation, use the mis-configured main voltage for the instrument may cause the main fuse blew.

Note: If the power supply is used to charge a battery, please pay attention to the positive and negative polarity to avoid any damage.

After power up, the instrument will automatically perform a self test routine. If the power

supply doesn't work, then refer to section 1.2.5.

1.2.3 Checkout procedure

After power on, during the self test, the following should be displayed on the VFD:



Picture 3

Followed by



Picture 4

The first row displays the voltage value for the three channels; the second row displays the current value or the output OFF state.

About 1S later, if EEPROM was damaged, then the VFD will display (about 2S):



Picture 5

If the latest operation state of the power supply was lost, then the VFD will display (about 2S):



Picture 6

During channel scan, the VFD will display:



Picture 7

When checkout for one channel is failed, then the VFD will display (about 2S):



Picture 8

When the calibration data of one or more channel is lost, then the VFD will display (about 2S):



Picture 9

When the factory calibration data of one or more channel is lost, then the VFD will display

(about 2S):



Picture 10

1.2.4 Output verification

The following procedures verify that the power supply outputs the correct voltage and current levels and properly responds to entries from the front panel.

Voltage Output Check

The following steps verify basic voltage function without load.

- 1) Press Power key to turn on the power supply
- 2) Press **On/Off** key to enable the output
Note: when **Meter key is gray, the power supply is in SET mode, then the VFD displays the set voltage and current; when the key is lit, then the power supply is in METER mode, the actual voltage and current display on the VFD. When the output is OFF, the ---- will display at the current display area.**
- 3) Set the voltage value
 Adjust the voltage, then press **Meter** to lit the key (indicates it is in the METER mode), make sure that the set value and output value are same, and if the current displayed on the VFD is nearly 0A.
- 4) Make sure the voltage can be adjusted from zero to the maximum rated value.
- 5) Check the other two channels by the same method.

■ Current output Check

The following steps check the basic current functionality by shorting the power supply's output.

- 1) Press Power key to turn on the power supply
- 2) Press **On/Off** to disable the output, ensure the output is OFF.
- 3) Connect a short across (+) and (-) output terminals with an insulated test lead, use a wire sufficient to handle the maximum current.
- 4) Adjust the voltage value to 3V
- 5) Press **On/Off** to enable the output
- 6) Adjust the current
 Set some different current values, in METER mode, check whether the voltage value on VFD is near 0v, and the current on it is close to the value you set.
- 7) Make sure that the current can be adjusted from 0 to full rated value.
- 8) Disable the output and then remove the short wire
- 9) Check the other two channels by the same method.

1.2.5 If the power supply does not turn on

Use the following steps to help resolve the problems you might encounter when turn on the instrument:

- 1) Verify that there is AC power applied to the power supply

First, verify that the power cord is firmly plugged into the power receptacle on the rear panel of the power supply. You should also make sure that the power source you plugged the power supply into is energized. Then, verify that the power supply is turned on.

2) Verify the power-line voltage setting

Make sure the voltage selector switch is set according to the present line voltage (110VAC or 220VAC) when the power supply is shipped from the factory. Change the voltage setting if it's not correct.

3) Verify the correct power-line fuse is installed

If the fuse was damaged, please see the table below to replace the fuse for your power supply.

Model	Fuse Spec
IT6302	Fuse 3.15A (220V AC)
	Fuse 6.30A (110V AC)

1.2.6 How to exchange the fuse

Open the small plastic cover below the power supply input socket on the back panel with a screwdriver, and you can see the fuse in it, please use the specifications in line fuse.

Remove the power cord and then use a screwdriver to remove the fuse box.



Use the same specification of fuse to replace the old one, install it to the fuse box and then insert.

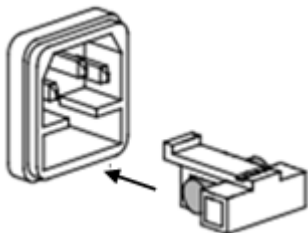

1.2.7 Adjust the carrying handle

To adjust the position, grasp the handle by the sides and pull outward. Then rotate the handle to the desired position.

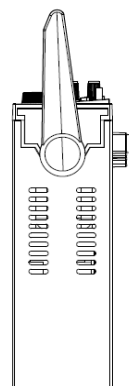
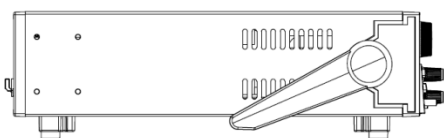

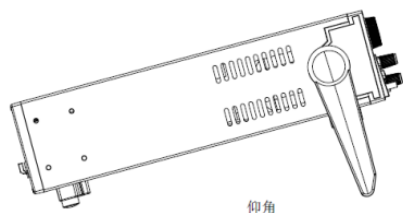

Bench operation

Handle

Picture 11

Chapter 2 Specification

2.1 Specification

Parameters		IT6302
Rated values (0 °C - 40 °C)	Voltage	0-30V×2, 0-5V×1
	Current	0-3A×2, 0-3A×1
	Power	CH1:90W,CH2:90W,CH3:15W
Load regulation (%of output + offset)	Voltage	≤0.01%+4mV
	Current	≤0.2%+3mA
Line regulation (%of output + offset)	Voltage	≤0.01%+4mV
	Current	≤0.2%+3mA
Setup resolution	Voltage	10mV
	Current	1mA
Read-back resolution	Voltage	10mV
	Current	1mA
Setup accuracy (Within 12 months) (25°C ± 5 °C) (%of output + offset)	Voltage	≤0.06%+20mV
	Current	≤0.2%+10mA
Read-back accuracy (25 °C ± 5 °C) (%of output + offset)	Voltage	≤0.06%+20mV
	Current	≤0.2%+10mA
Ripple and noise (20Hz-20MHz)	Voltage	≤5mVp-p and 1mVrms
	Current	≤6mArms
Setup Temperature Coefficient	Voltage	300ppm/°C
	Current	300ppm/°C

(%of Output/°C+Offset)		
Readback Temperature Coefficient (%of Output/°C+Offset)	Voltage	300ppm/°C
	Current	300ppm/°C
Rise time	Voltage	CH1≤150mS,CH2≤150mS,CH3≤150mS
Fall time	Current	CH1≤2.5S,CH2≤2.5S,CH3≤200mS
Transient Response Time	≤200uS (Typical)	
	Test conditions: 50% -100% Freq = 1K recovered to 75mV	
AC Input	Voltage 1	110V±10%
	Voltage 2	220V±10%
	Frequency	47HZ-63HZ
Setup stability-8h (%of Output +Offset)	Voltage	≤0.01%+10mV
	Current	≤0.1%+5mA
Readback stability-8h (%of Output +Offset)	Voltage	≤0.01%+20mV
	Current	≤0.1%+5mA
Fuse specification	6.3A(110V)/3.15A(220V)	
Command Response Time	20mS (Typical)	
Power Factor	0.7 (Typical)	
Maximum input current	4.5A(110V)/2.2A(220V)	
Maximum input apparent power	700VA	
Storage temperature	-10°C~70°C	
Protective function	LVP/OTP	
standard Interface	COM(TTL)	
Isolation (output to ground)	200V	
Working temperature	0~40°C	
Dimension (mm)	214.5mmW*88.2mmH*354.6mmD	
Weight(net)	7.1Kg	

2.2 Additional features

Suggested calibration frequency: 1time /Year

Line voltage supported (can be selected by the switch on the rear panel)

Option 01: 220VAC \pm 10%, 47 to 63 Hz

Option 02: 110 VAC \pm 10%, 47 to 63 Hz

Max input power

Module	IT6302
Power	750VA

Cooling

Fans

Operation temperature

0 to 40 °C

Storage temperature

-20 to 70 °C



Environmental conditions

Indore use only, max humidity 80%, no condensation.



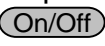

Chapter 3 Front-panel Operation

So far we have covered the quick start chapter which briefly introduced the front panel operation and how to check basic voltage and current functionality. This chapter describes in detail how to operate the instrument manually via the front-panel keys.

3.1 Front-panel Operation Overview

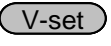
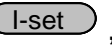
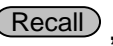
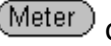
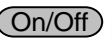

- The power supply is shipped from the factory ready for front-panel operation mode. At power-on, the power supply will automatically enter the front-panel operation mode and the instrument can be controlled via the front panel keys and knob.
- The power supply enters remote mode as soon as a valid remote command is received via the communication connector in the rear. Switching to remote mode does not impact the supply's output parameters. In remote mode, front-panel operation is disabled. Only Meter and Local buttons are enabled. If the power supply is in remote mode, and the  (Local) key is enabled, you can revert to manual mode by pressing the  (Local) key.
- The power supply is in Set mode when it is powered on. In this mode, the VFD will display the setting voltage and current.
- The output of power supply can be enabled/disabled from the front panel by pressing the  button. When turn on the output, the VFD will display the state and voltage/current of each channel. "CC" represents constant current mode. "CV" represents

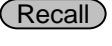
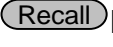
constant voltage mode. **When output is in OFF mode, VFD will have no any indicators of CC or CV.**

- The VFD also displays operation states or error information. “” means the power supply is in remote mode. When front-panel keys are locked,  button will be lit. For more details, please refer to chapter of “Descriptions about VFD marks”
- If the power supply is in set mode, you can modify parameters using the knob. If the power supply is in menu operation, the knob is used for menu selection.
- When , , ,  or  buttons are lit, means they are selected and under corresponding state now. If pressing  (Shift)+  (Save),  button will keep flickering and waiting for a number to be entered to specify the memory location.
- When V-SET/I-SET buttons are lit, following conditions will enable the cursor to display again.
Pressing V-SET/I-SET buttons again
Adjusting the knob
Pressing direction buttons

Note: If there is any operation on front panel within 5S, the cursor will disappear automatically. You can also disable the cursor by pressing ESC button. When VFD displays cursor, you can modify the parameters by adjusting knob or up/down keys, or move the cursor by right/left keys.

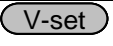
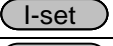
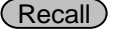
Details about key buttons' state:

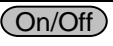
	When button is lit, means you can set voltage. When button keeps flickering, means in LVP setting mode.
	When button is lit, means in current setting mode.
	When button is lit, means in recall mode When button keeps flickering, means in save mode and waiting for a number to be entered to specify the memory location.
	When button is lit, means current VFD displays actual voltage and current.
	When button is lit, means at least one channel output is on. Or all channels are in OFF mode.

Note: , ,  buttons will not be lit at the same time.

3.2 Panel Description

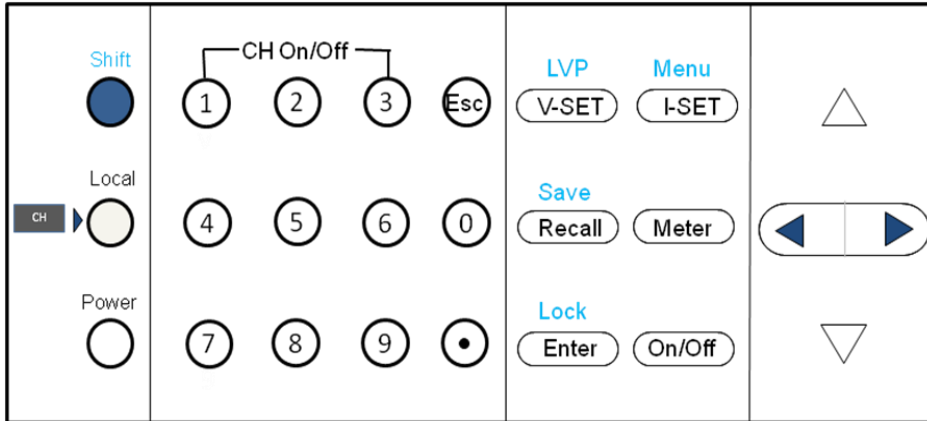



Picture 12





0-9	Numeric keys. Use keys 1~3 to control the output state of the 3 channels which should coordinate with Shift key. Note: In key lock mode, this function is disabled.
	Escape from the current setting or menu item.
(Shift)	Compound key
(Local)	Use to switch to local operation mode
(Power)	Use to power on/off the DC source
/LVP	Use to set the voltage or shift+V-set to set LVP value
/Menu	Use to set the current or shift+I-set to enter the menu operation.
/Save	Save or recall different operating parameters in memory locations
	Switch the display between setting value and actual value
/Lock	Enter button to confirm the selection or setup/Shift+Enter to lock the front keys
	Use to control the output state of each channel
	Right/Left key, use to move the cursor or scroll through the menu items
	Up/down key, use to increase or decrease the setting value
	Use to turn on the output of corresponding channel no matter in menu operation or Meter state

3.3 VFD Description

Explanation of enunciators on the display

CC	In constant current mode
CV	In constant voltage mode
	open the remote sense function
	Indicates the shift button is pressed
	Indicates the channel currently selected
SER	Open serial connection mode
PARA	Open parallel connection mode
TRA	Enable tracking mode

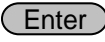

3.4 Menu Description

Press  (Shift)+  (Menu) to indicate operation mode. View the menu on the VFD, and use the right/left key to change the setup, and up/down key to scroll through the complete menu items. Press  to enter the selected menu function. Press  button to return to the previous menu. When the item keeps flickering indicates it is selected currently.

Note: Both pressing Enter and down arrow key can display the next menu. But the difference between the two methods is as follows: press enter key can save the current setup, while press up/down key will not change the previous setup.

3.5 Panel Operation

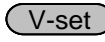
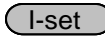



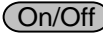
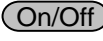

3.5.1 Channel Operation

When  or  button is lit, press  (Local) key can switch between the three channels.

3.5.2 OUT ON/OFF

Pressing  button toggles the output state of all 3 channels of the power supply. If the output state is ON, press it, to turn the output state to OFF. While the output state is OFF, press  and the power supply output will turn ON.

To control channels individually, press  (Shift)+  ① ,  (Shift)+  ② ,  (Shift)+  ③



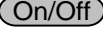

corresponding to each channel.  (Shift)+  controls the output state of the first channel,  (Shift)+  controls the output state of the second channel,  (Shift)+  controls the output state of the third channel.



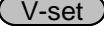
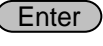

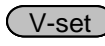

When the power supply is in remote mode, you can set the output state by sending SCPI command (OUTPut: ON | OFF). The output state operation does not affect any other parameter.

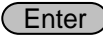
Note: The  key controls the output state of all 3 channels simultaneously. If you want to control the output state of individual channels, use the number keys 1-3 with shift button.

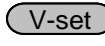
3.5.3 Set Voltage

Solution 1: press  (Local) to select channel, press  then enter a numerical value followed by .



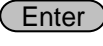

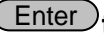
Solution 2: Press , then press   to move the cursor position and adjust the voltage value using the knob. Press  or  to exit.



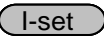
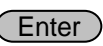

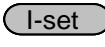

Solution 3: Press , then press   to move the cursor position and adjust the voltage value using  . Press  or  to exit.

Note: When output in OFF mode an  button is dark, rotary knob and up/down keys cannot be used to adjust voltage and current. If rotary knobs are enabled, then adjusting it will real-time to change the current output setup without press  to confirm.

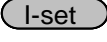
3.5.4 Current Operation

Solution 1: press  (Local) to select channel, press  then enter a numerical value followed by .

Solution 2: Press , then press   to move the cursor position and adjust the current value using the knob. Press  or  to exit.

Solution 3: Press , then press   to move the cursor position and adjust the current value using  . Press  or  to exit.

3.5.5 Save and Recall Operation

You can store up to 27 different operating states in memory locations 1 through 27. They are divided to three groups, each group includes nine different setups. Each operating state includes a constant voltage value, constant current value, maximum output voltage.

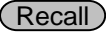
Press  (Shift) +  (Save) followed by a number key to save the current operating state to non volatile memory.

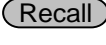
Press  + number 1 to 9 to recall operating state assigned to this location.

You can also use the SCPI command (*SAV, *RCL) to save and recall.



When Save operation is done, there will be a corresponding information to indicate the successful or failed operation. While for Recall operation, only information to indicate failed recall.

Note: The power supply doesn't support Save/Recall operation when in serial/parallel or tracking mode.

If in serial/parallel mode and do Save/Recall operation, the VFD will display INV OPER (invalid Operation) to remind the user of a wrong operation.

If parameters want to be recalled do not exist, the current value position on VFD will display ----, and then resume after 2S.





3.5.6 LVP operation

Press  (Local) button to select the channel, press  (Shift) +  (LVP), then the voltage display position of the selected channel will change to display LVP, meanwhile current value position will keep flickering and waiting for a numerical value to be entered. You can directly use keyboards or by cursor + knob ways to enter the LVP value. Press Esc can quit the operation.

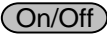

After setting a LVP value, user can only set a voltage less than LVP point.

3.5.7 Key Lock Set

Press  (Shift) +  (Lock) can lock the front panel keys, and under lock condition,  button will be lit.

In key lock mode, all keys are disabled, except , , , , , right/left keys and  (Local) key.

In key lock state, you still can use  (Local) and right/left key to select channel.

, ,  (On/Off) can control the output state of corresponding channel without

coordinating with shift button.

3.5.8 Protections

Over Temperature Protection

If the internal temperature of the power supply exceeds 85°C, the instrument will protect itself by automatically turning power OFF. When this happens you will hear a buzzer and the display will indicate the following:



Picture 13

Over Voltage Protection (OVP)

IT6302 has over voltage protection function at power on. OVP function may be triggered because of internal error, customer's wrong operation or too higher external voltage. Once the power supply is protected, will the user hear a buzzer and output will be turned off, meanwhile corresponding channel will display OVP in voltage value position and current value position will display " - - - -".

OVP value is higher 0.1V than the current max voltage set.

3.6 Menu Description

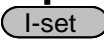
Press  (Shift) +  (Menu) to enter menu operation.

Out		
	OFF	Output resumes to OFF mode at power on.
	Last	"remember" output On/Off state before power off
Beep		
	OFF	Disable buzzer
	ON	Enable buzzer
BAUD		
	4.8	Baudrate 4800
	9.6	Baudrate 9600
	38.4	Baudrate 38400
Grp		
	Grp1	Save to group1
	Grp2	Save to group2
	Grp3	Save to group3
COUP		Configure connection mode between CH1&CH2
	OFF	Cancel the series or parallel relationship between CH1&CH2

	Ser	Configure for serial operation
	Par	Configure for parallel operation
TRAC	Set the tracking mode of CH1&CH2	
	OFF	Disable tracking function
	ON	Enable tracking function

Out

This parameter sets the output On/Off state at power up. If you select “Last”, the power supply will save the output state prior to power down and revert to that state at power up. If you select “Off”, the output state is always “OFF” when the power supply is turned on. The recommend setting is “OFF”.

Beep

This parameter turns the beep sound for key presses “On” or “Off”.

When switch power supply between CV and CC mode, the enabled buzzer will beep two sounds.

BAUD

This parameter configures the baudrate for serial communication. Possible values are 4800,9600 or 38400.

When operating the power supply in remote mode, make sure that you configure identical baudrate settings for the power supply and the computer.

Grp

This parameter sets the memory region for Save/Recall operation. The non-volatile memory location is divided to three regions: Grp1, Grp2 and Grp3.Each group can save nine different setups. User can save up to 27 different setups to assigned location.

COUP

This parameter configures the connection mode of CH1 and CH2. Corresponding setup in the menu includes Off, Ser, Par.

IT6302 only supports to set Serial/Parallel mode for CH1 and CH2 in menu operation. When set Serial/Parallel mode, VFD will have corresponding symbols at the position of CH2. In this mode, user only need to set the total current on one channel, the power supply can distribute the current to the two channels automatically.

If having no COUP set in the menu, then all 3 channels can be connected in Serial or Parallel mode in hardware. Under this condition, the output of all 3 channels should be set separately.

Off (release Serial/Parallel setup of CH1 and CH2)

This parameter releases the Serial/Parallel setup of CH1 and CH2, then press **Enter**, VFD will display "OFF SUCC".

The default setup is Off. In this mode, 3 channels output individually.

Wiring in OFF state

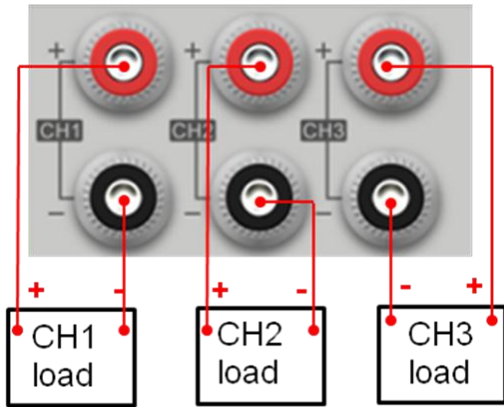

Ser (Series mode)

This parameter configures connection mode of CH1 and CH2 to serial mode in menu operation. Press **Enter** to confirm or **Esc** to quit the operation.

To set serial mode of CH1 and CH2 in menu, press **(Shift) + I-set (Menu)** and scroll through the menu list by Up/Down key to select COUP, using Right/Left key to select SER, press **Enter** to confirm. VFD will indicate "Ser SUCC" when operation is done. And system will quit menu after 2s. For example, in output off state and Meter selected mode, VFD displays as follows:



Picture 14

Wiring in serial mode:

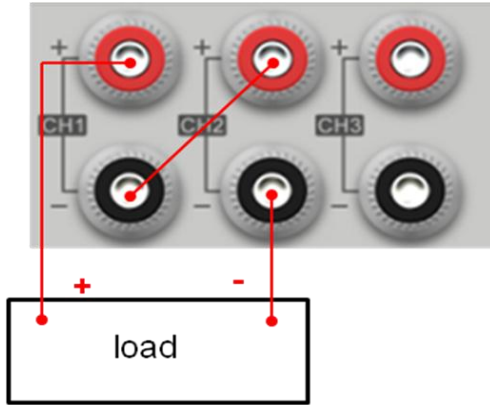

Par (Parallel mode)

This parameter configures connection mode of CH1 and CH2 to parallel mode in menu operation. Press **Enter** to confirm or **Esc** to quit the operation.

To set parallel mode of CH1 and CH2 in menu, press **(Shift) + I-set (Menu)** and scroll through the menu list by Up/Down key to select COUP, using Right/Left key to select PARA, press **Enter** to confirm. VFD will indicate "Para SUCC" when operation is done. And system will quit menu after 2s. For example, in output off state and Meter selected mode, VFD displays as follows:



Picture 15

Wiring in Parallel mode

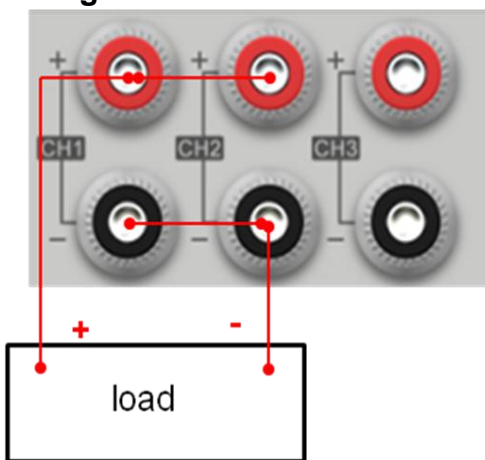

Select parameters of series-parallel connection

Select parameters of CH1 and CH2 will be back to default automatically (voltage: 0V, current: 3.1A) after connect in series.

Select the total current value of CH1 and CH2 will be set to 6.2A automatically, and voltage value is still 0V after connect in parallel.

Select limit voltage in series-parallel connection

If limit voltage values of CH1 and CH2 are set as 20V, 25V before series-parallel connection:

The voltage range will be 45V (sum of the two channels) after connect in series;

The voltage range will be 20V (min value of the two channels) after connect in parallel;

Notice: the status of CH1 and CH2 are OFF when change connection mode; in the meanwhile, voltage will be back to 0V; and you need to reset output parameters. However, voltage, current and output status of CH3 could not be affected.

After connect in series/parallel, save and recall function are forbidden. When select series or parallel connection, hardware connection is needed.

TRAC (sync output setting)



The TRACK function of IT6302 could change voltage/current of CH1, CH2 in scale.

When select it, CH1 and CH2 could be set as synchronous mode; choose "On"

status, and press  to confirm; and then press  to exit.

Please set voltage and current of CH1 and CH2 before this setting. The relevant parameters of other channels will be changed in scale when one parameter changed in the synchronous mode.

For example, set voltage and current of CH1 and CH2 as follows, CH1: 4V, 1A; CH2: 8V,

2A. Press  (Shift) +  (Menu) into Menu, and press  to select TRAC, VFD will display as follows:



Picture 16

Select "ON" by left-right key and press  to set CH1 and CH2 in synchronous mode and the VFD will display "TRAC SUCC". After two seconds later, the system will automatically exit the Menu.

When output is off and in Meter status, VFD will display:



Picture 17

In setting status, if voltage of CH1 is set as 2V, voltage of CH2 will be automatically sync to 4V (in scale)

If don't need sync function, please set the TRAC to OFF status. The steps as follow: press

● (Shift) + **I-set** (Menu) into Menu, and press ▼ to select TRAC, and select OFF by

left-right key and at last press **Enter** to confirm, VFD display "OFF SUCC", after two seconds later, the system will automatically exit the Menu.

Notice: if the voltage/current of CH1/CH2 is set as zero before sync, voltage/current synchronous operation of this channel will be ignored.

If need to check whether it is in sync status, please change output to OFF and check in Meter status. There is no TRAC mark in normal status.

Power Information

Press ● (Shift) + ⊕, VFD will display power information; the information includes the following parts:

Power Model

Display the model of power supply: IT6302

Soft Version

Software version of power supply: 1.XX

Press left-right key or conversion knob, will display the following information:

Series number of product

INFO SN

XXXX XXXX XXXX

Calibration date

INFO - - -1

XXXX XXXX XXXX

Calibration time

INFO - - - 2

XXXX XXXX XXXX

Chapter 4 Communication between power supply and PC

4.1 Communication module introduction

The DB9 interface connector on the rear panel of IT6302 power supply is TTL level, and you need to use level converter to connect PC series port.

Notice: please don't connect IT6302 with standard RS232 cable. It may damage the power supply.

4.1.1 IT-E121 communication module

The DB9 interface connector on the rear panel of IT6302 power supply is TTL level. You need to use IT-E121 communication module and standard RS232 straight-through cable to connect DB9 interface connector of power supply and RS232 interface connector of PC.

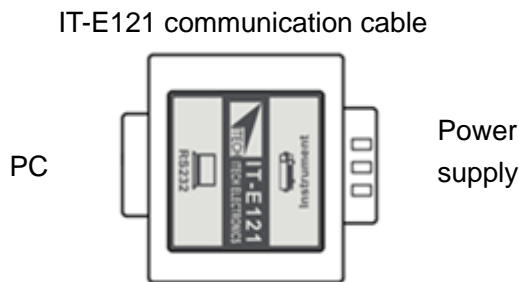

4.1.2 IT-E122 communication module

The DB9 interface connector on the rear panel of IT6302 power supply is TTL level. You could use IT-E122 communication module and standard USB straight-through cable (one end is B connector, and the other end is A connector) to connect DB9 interface connector of power supply and USB interface connector of PC.

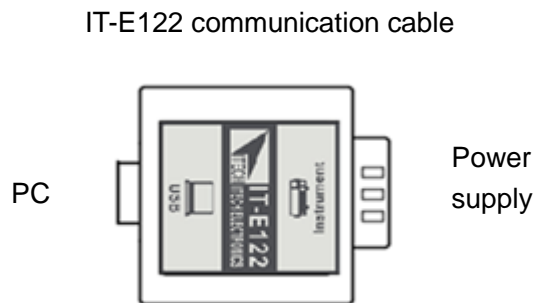

4.2 Communication between power supply and PC

Using a Level converter circuit connect DB9 interface connector of IT6302 and RS232/USB interface connector of PC to do communication.

Below will help you to have the knowledge of controlling IT6302 power supply via PC.

1. Communication setting

Before communicate, please set the following parameters of power supply and PC to make them match with each other.

Press  (Shift) +  (Menu) to enter menu operation and select the BAUD.

BAUD		
	4.8	Baudrate 4800
	9.6	Baudrate 9600
	38.4	Baudrate 38400

2. DB9 series interface

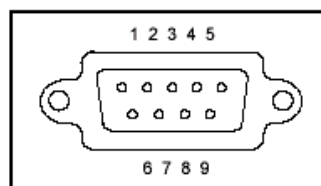

Connect an IT-E121 or IT-E122 module to the DB9 interface, and then use an appropriate communication cable to connect the module and PC.

3. Software and SCPI protocol

We provide free IT9000 software for IT6302 power supply. Please download the software and its manual from our website: www.itechate.com. For second development, please don't hesitate to contact us.

Support process

If you have a problem, follow these steps:

1 Check the documentation for the product

2 Visit the ITECH online service Web site is www.itechate.com ,ITECH is available to all ITECH customers. It is the fastest source for up-to-date product information and expert assistance and includes the following features:

Fast access to email AE

Software and driver updates for the product

Call ITECH support line 4006-025-000

