

Products Catalog

EMC/ESD Components

- Common mode Noise Filters
- ESD Suppressor
- Multilayer Varistor

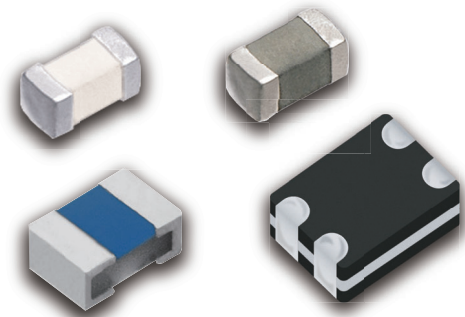

**IN Your
Future**



EMC components / ESD components contents INDEX

Classification	Product item	Size (mm)	Representative application	Part No.	Page	
Guidelines and precautions					1	
Safety precautions					2	
(Common Mode Noise Filters/Array, Common Mode Noise Filters/Array with ESD Suppressor, 2 Mode Noise Filters)					2	
EMC Components	Common Mode Noise Filters	0605	USB 3.2, HDMI 2.1	EXCX4CZ	4	
			USB 3.1, MIPI 2.0	EXCX4CH	7	
			USB 2.0, MIPI 1.1	EXCX4CE	9	
			—	EXCX4CT NRFND	11	
		0806	USB 3.1, HDMI 2.0	EXC14CH	13	
			USB 2.0, HDMI 2.0	EXC14CG/CE	15	
			MIPI 2.1	EXC14CT	18	
			MIPI 1.1	EXC14CX	20	
		0906	MIPI C-PHY 2.1	EXC16CT	22	
		1210	USB 3.2, HDMI 2.1	EXC24CK NEW	24	
			USB 3.2, HDMI 2.0	EXC24CH	26	
			HDMI 1.2, LVDS	EXC24CG	28	
			USB 2.0, LVDS	EXC24CE/CF	30	
		2012	USB 2.0, LVDS	EXC34CG/CE	33	
		Common Mode Noise Filters Array	1608	USB 2.0, LVDS	EXC18CG/CE	35
			2010	USB 3.2, HDMI 2.0	EXC28CH	37
	HDMI 1.2, LVDS			EXC28CG	39	
	USB 2.0, LVDS			EXC28CE	41	
	Common Mode Noise Filters Array / Packaging methods, Land pattern and Soldering conditions					43
	Common Mode Noise Filters with ESD Suppressor				EXC14CS NRFND	45
	Common Mode Noise Filters with ESD Suppressor				EXC24CS NRFND	47
	Common Mode Noise Filters Array with ESD Suppressor				EXC18CS NRFND	49
	Common Mode Noise Filters with ESD Suppressor / Packaging methods and Soldering conditions					51
	Common Mode Noise Filters with ESD Suppressor / Replacement list for "Not recommended for new design"					53
	2 Mode Noise Filters	0806	Mobile voice line	EXC14CP	54	
1012		Mobile voice line	EXC24CB/CP/CN	56		
2 Mode Noise Filters / Packaging methods, Land pattern and Soldering conditions					59	
Common Mode Noise Filters / Performance					61	
Safety precautions (ESD Suppressor Array)					62	
ESD Suppressor	1005/1608	Antenna/ Differential transmission line	EZAEG 2A, 3A	64		
		Antenna/ Differential transmission line	EZAEG 1N, 2N	66		
	ESD Suppressor Array	2012	Differential transmission line	EZAEG CA	68	
	ESD Suppressor high withstanding type	1608	Automotive antenna/ Differential transmission line	EZAEG 3W	70	
ESD Suppressor Array / Packaging methods, Soldering conditions					72	
Safety precautions (Multilayer Varistor : Automotive Grade)					73	
Multilayer varistor (Automotive grade)	1005/1608	Automotive transmission line/ power line	EZJZ-M / EZJP-M	81		
Multilayer Varistor (Automotive Grade) / Characteristics, Performance, packaging					83	
Safety precautions (Multilayer Varistor)					86	
Multilayer varistor (DC voltage lines / High speed signal lines)	0603/1005/ 1608	For power supply and signal circuits	EZJZ / EZJP	94		
Multilayer varistor (DC voltage lines)	1608/2012	For power circuits	EZJS	99		
Multilayer Varistor / Characteristics, Applications, Performance, packaging					101	

Guidelines and precautions regarding the technical information and use of our products described in this online catalog.

- If you want to use our products described in this online catalog for applications requiring special qualities or reliability, or for applications where the failure or malfunction of the products may directly jeopardize human life or potentially cause personal injury (e.g. aircraft and aerospace equipment, traffic and transportation equipment, combustion equipment, medical equipment, accident prevention, anti-crime equipment, and/or safety equipment), it is necessary to verify whether the specifications of our products fit to such applications. Please ensure that you will ask and check with our inquiry desk as to whether the specifications of our products fit to such applications use before you use our products.
- The quality and performance of our products as described in this online catalog only apply to our products when used in isolation. Therefore, please ensure you evaluate and verify our products under the specific circumstances in which our products are assembled in your own products and in which our products will actually be used.
- Please ensure the safety by means of protection circuit, redundant circuit etc. in your system design in order to prevent the occurrence of life crisis and other serious damages due to the failure of our products.
- The products and product specifications described in this online catalog are subject to change for improvement without prior notice. Therefore, please be sure to request and confirm the latest product specifications which explain the specifications of our products in detail, before you finalize the design of your applications, purchase, or use our products.
- The technical information in this online catalog provides examples of our products' typical operations and application circuits. We do not guarantee the non-infringement of third party's intellectual property rights and we do not grant any license, right, or interest in our intellectual property.
- If any of our products, product specifications and/or technical information in this catalog is to be exported, the laws and regulations of the exporting country, especially with regard to security and export control, shall be observed.

<Regarding the Certificate of Compliance with the EU RoHS Directive/REACH Regulations>

- The switchover date for compliance with the RoHS Directive/REACH Regulations varies depending on the part number or series of our products.
- When you use the inventory of our products for which it is unclear whether those products are compliant with the RoHS Directive/REACH Regulation, please select "Sales Inquiry" in the website inquiry form and contact us.

Please note that we do not owe any liability and responsibility if our products are used beyond the description of this catalog or without complying with precautions in this catalog.



Application Guidelines

(Common Mode Noise Filters/Array,
Common Mode Noise Filters/Array with ESD Suppressor, 2 Mode Noise Filters)

1. Safety precautions

- Make sure to exchange product specifications before using this product, regardless of the intended use. The design and specifications in this catalog are subject to change without prior notice.
- Do not use the products beyond the specifications described in this catalog.
- This catalog explains the quality and performance of the products as individual components. Before use, check and evaluate their operations when installed in your products.
- If a malfunction of this product may result in the loss of human life or other serious damage in transportation equipment (trains, automobiles, ships, etc.), signaling equipment, medical equipment, aerospace equipment, electric heating equipment, combustion and gas equipment, rotating equipment, disaster prevention and security equipment, and other equipment, ensure safety by implementing a fail-safe design with the following system.
 - * Systems equipped with a protection circuit and a protection device.
 - * Systems equipped with a redundant circuit or other system to prevent an unsafe status in the event of a single fault.

2. Precautions for use

- These products are designed and manufactured for general and standard use in general electronic equipment (e.g. AV equipment, home electric appliances, office equipment, information and communication equipment). If the product is to be used in an application that requires special quality and reliability and where failure or malfunction of the product may directly threaten human life or cause bodily harm (e.g., aerospace equipment, transportation equipment, combustion equipment, medical equipment, disaster prevention and security equipment, safety devices, etc.), be sure to consult with our sales office in advance and exchange product specifications appropriate for the application.
- These products are not intended for use in the following special conditions. Before using the products, carefully check the effects on their quality and performance, and determine whether or not they can be used.
 1. In liquid, such as water, oil, chemicals, or organic solvent.
 2. In direct sunlight, outdoors, or in dust.
 3. In salty air or air with a high concentration of corrosive gas, such as Cl_2 , H_2S , NH_3 , SO_2 , or NO_x .
 4. Electric Static Discharge (ESD) Environment.
These components are sensitive to static electricity and can be damaged under static shock (ESD). Please take measures to avoid any of these environments. Smaller components are more sensitive to ESD environment.
 5. Electromagnetic and Radioactive Environment.
Avoid any environment where strong electromagnetic waves and radiation exist.
 6. In an environment where these products cause dew condensation.
 7. Sealing or coating of these products or a printed circuit board on which these products are mounted, with resin or other materials.
- These products generate Joule heat when energized. Carefully position these products so that their heat will not affect the other components.
- Carefully position these products so that their temperatures will not exceed the category temperature range due to the effects of neighboring heat-generating components. Do not mount or place heat-generating components or inflammables, such as vinyl-coated wires, near these products.
- Note that non-cleaning solder, halogen-based highly active flux, or water-soluble flux may deteriorate the performance or reliability of the products.
- Carefully select a flux cleaning agent for use after soldering. An unsuitable agent may deteriorate the performance or reliability. In particular, when using water or a water-soluble cleaning agent, be careful not to leave water residues. Otherwise, the insulation performance may be deteriorated.
- Do not apply flux to these products after soldering. The activity of flux may be a cause of failures in these products.
- Refer to the recommended soldering conditions and set the soldering condition. High peak temperature or long heating time may impair the performance or the reliability of these products.
- Recommended soldering condition is for the guideline for ensuring the basic characteristics of the products, not for the stable soldering conditions. Conditions for proper soldering should be set up according to individual conditions.
- Do not reuse any products after removal from mounting boards.
- Do not drop these products. If these products are dropped, do not use them. Such products may have received mechanical or electrical damage.
- If any doubt or concern to the safety on these products arise, make sure to inform us immediately and conduct technical examinations at your side.

3. Precautions for storage

The performance of these products, including the solderability, is guaranteed for a year from the date of arrival at your company, provided that they remain packed as they were when delivered and stored at a temperature of -5 °C to +40 °C and a relative humidity of 15 % to 75 %.

Even within the above guarantee periods, do not store these products in the following conditions. Otherwise, their electrical performance and/or solderability may be deteriorated, and the packaging materials (e.g. taping materials) may be deformed or deteriorated, resulting in mounting failures.

1. In salty air or in air with a high concentration of corrosive gas, such as Cl₂, H₂S, NH₃, SO₂, or NO_x.
2. In direct sunlight.

<Package markings>

Package markings include the product number, quantity, and country of origin.

In principle, the country of origin should be indicated in English.

4. Precaution specific to this product

1. Use rosin-based flux or halogen-free flux.
2. For cleaning, use an alcohol-based cleaning agent. Before using any other type, consult with our sales person in advance.
3. Mounting of the suppressors with excessive or insufficient wetting amount of solder may affect the connection reliability or the performance of the suppressors. Carefully check the effects and apply a proper amount of solder for use.
4. Do not apply shock to Filters or pinch them with a hard tool (e.g. pliers and tweezers). Otherwise, their bodies may be chipped, affecting their performance. Excessive mechanical stress may damage the filters. Handle with care.
7. Avoid excessive bending of printed circuit boards in order to protect the suppressors from abnormal stress.
8. Do not immerse the suppressors in solvent for a long time. Before using solvent, carefully check the effects of immersion.
9. Do not apply excessive tension to the terminals.

Common Mode Noise Filters

EXCX4CZ type



Features

- Small and thin (L 0.65 mm×W 0.50 mm×H 0.30 mm)
- High-common mode attenuation at 2.4GHz or higher, Suitable for noise suppression at Wi-Fi band
- Strong multilayer/sintered structure, excellent reflow resistance and high mounting reliability
- Lead, halogen and antimony-free
- RoHS compliant

Recommended applications

- Smartphones, Tablet PCs and DSC
- Suppresses noise radiation to Wi-Fi Equipment

Explanation of part numbers

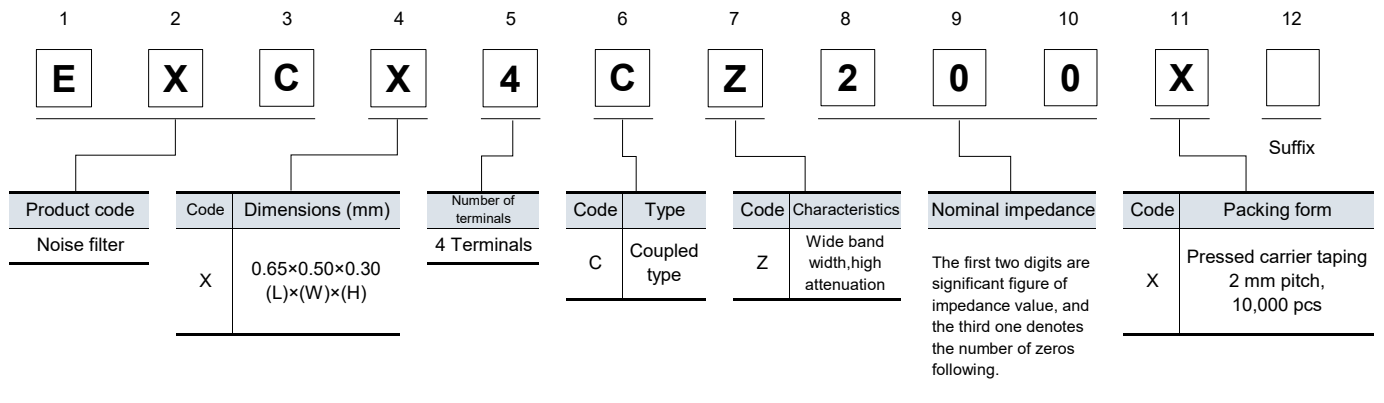

Construction

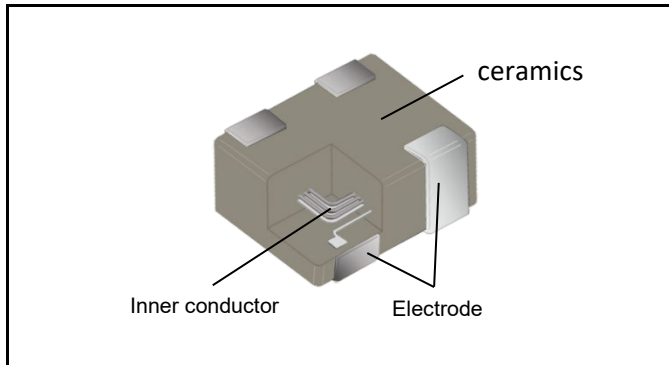

Circuit configuration (No polarity)

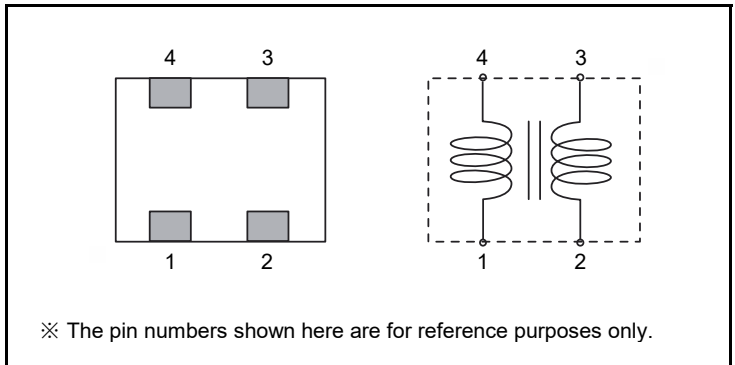

Dimensions in mm (not to scale)

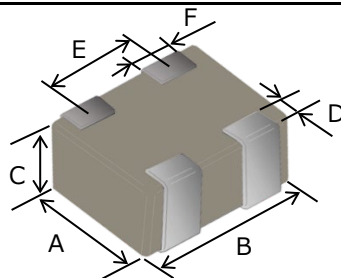

Unit : mm

Part No. (inch size)	Dimensions						Mass (Weight) (mg/ pc.)
	A	B	C	D	E	F	
EXCX4CZ (0202)	0.50 ± 0.05	0.65 ± 0.05	0.30 ± 0.05	0.12 ± 0.10	0.40 ± 0.10	0.15 ± 0.10	0.28

Ratings

Part number	Impedance (Ω) at 100 MHz	Rated voltage (V) DC	Rated current (mA) DC	DC resistance (Ω)
	Common mode			
EXCX4CZ040X	$4 \Omega \pm 2 \Omega$	5	100	$1.0 \pm 30 \%$
EXCX4CZ090X	$9 \Omega \pm 3 \Omega$	5	100	$1.9 \pm 30 \%$
EXCX4CZ200X	$20 \Omega \pm 30 \%$	5	100	$3.0 \pm 30 \%$

● Category temperature range $-40 \text{ }^\circ\text{C}$ to $+85 \text{ }^\circ\text{C}$

Impedance characteristics (Typical)

● EXCX4CZ040X

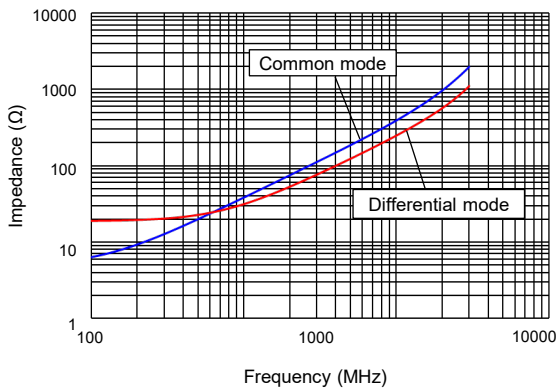

● EXCX4CZ090X

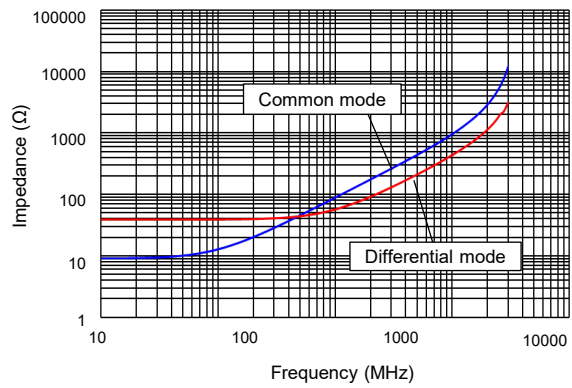

● EXCX4CZ200X

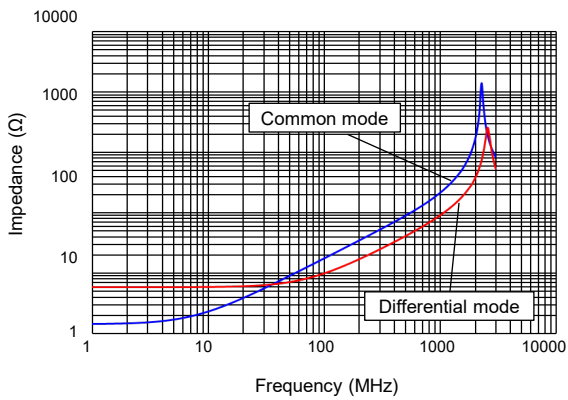

● Measurement circuit

(A) Common mode

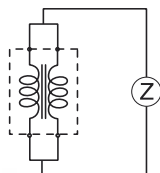

(B) Differential mode

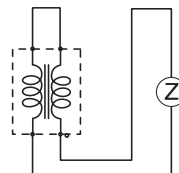

Ratings

● EXCX4CZ040X

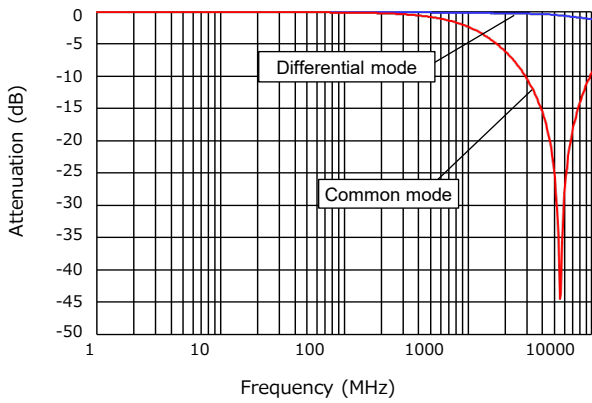

● EXCX4CZ090X

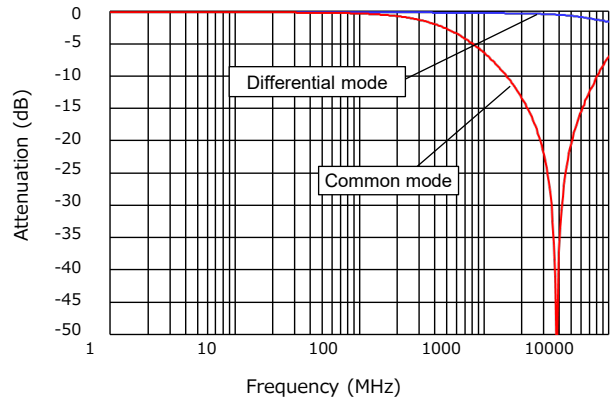

● EXCX4CZ200X

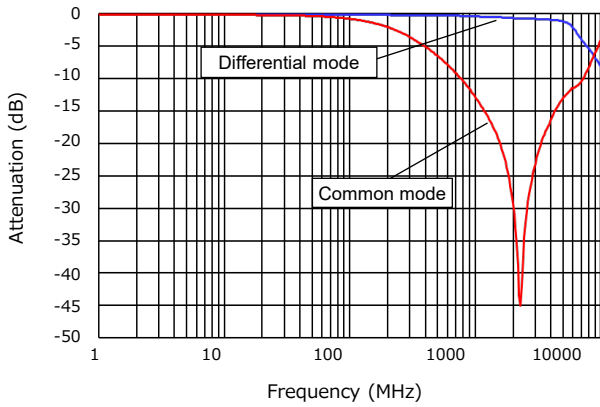

■ As for packaging methods, soldering conditions and safety precautions, please see data files

Common Mode Noise Filters

EXCX4CH type

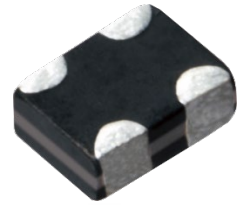

Features

- Small and thin (L 0.65 mm×W 0.50 mm×H 0.30 mm)
- High common mode attenuation in high-speed differential transmission lines, Cut-off frequency is more than 8.5 GHz, and an influence to differential transmission signal quality is little
- Strong multilayer/sintered structure, excellent reflow resistance and high mounting reliability
- Lead, halogen and antimony-free
- RoHS compliant

Recommended applications

- Smartphones, Tablet PCs and DSC
- Noise suppression of high-speed differential data lines such as USB, LVDS and HDMI

Explanation of part numbers

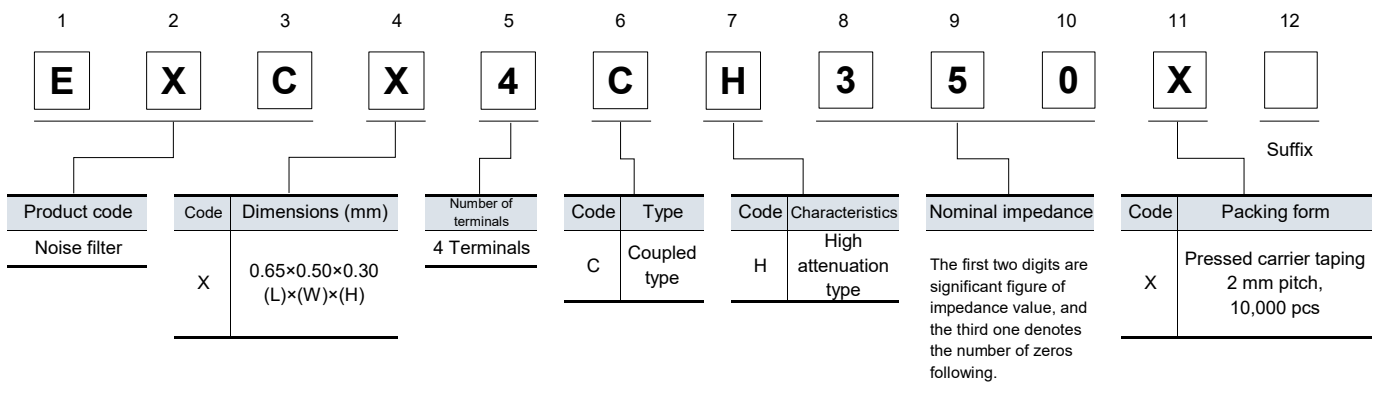

Construction

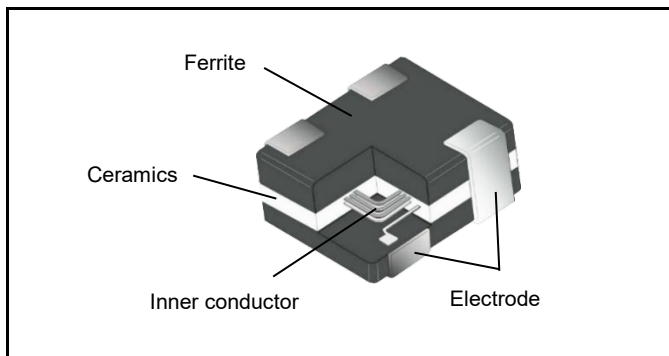

Circuit configuration (No polarity)

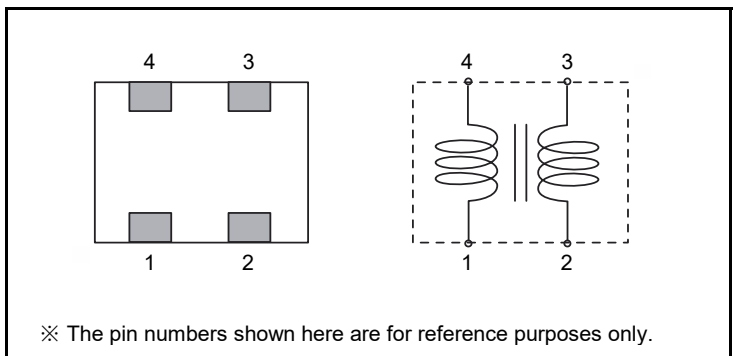

Dimensions in mm (not to scale)

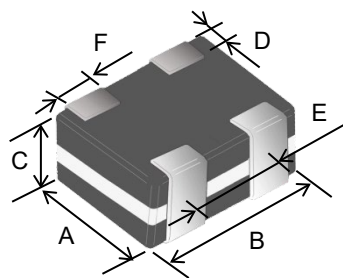

Unit : mm

Part No. (inch size)	Dimensions						Mass (Weight) (mg/ pc.)
	A	B	C	D	E	F	
EXCX4CH (0202)	0.50±0.05	0.65±0.05	0.30±0.05	0.12±0.10	0.40±0.10	0.15±0.10	0.43

Ratings

Part number	Impedance (Ω) at 100 MHz	Rated voltage (V) DC	Rated current (mA) DC	DC resistance (Ω) max.
	Common mode			
EXCX4CH120X	12 Ω ±5 Ω	5	100	2.0
EXCX4CH350X	35 Ω ±30 %	5	100	2.7

● Category temperature range -40 °C to +85 °C

Impedance characteristics (Typical)

● EXCX4CH120X

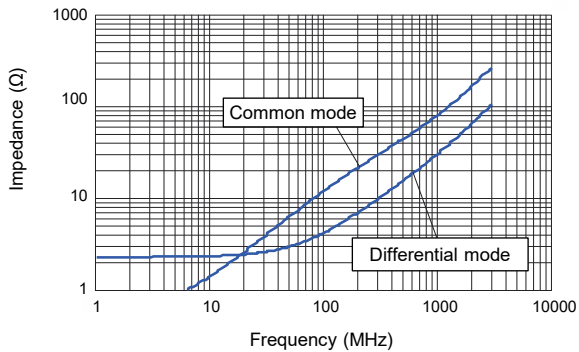

● EXCX4CH350X

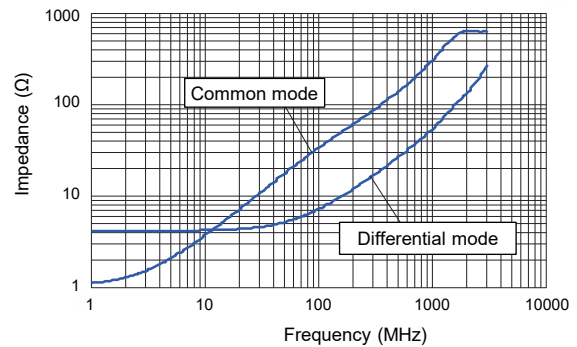

● Measurement circuit

(A) Common mode

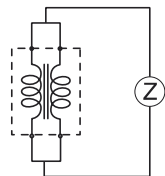

(B) Differential mode

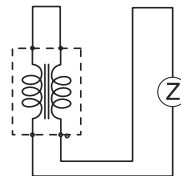

Common mode attenuation characteristics (Scc21), differential mode insertion loss characteristics (Sdd21) (reference data)

● EXCX4CH120X

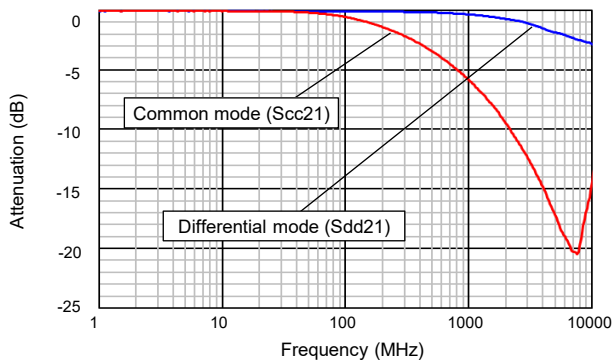

● EXCX4CH350X

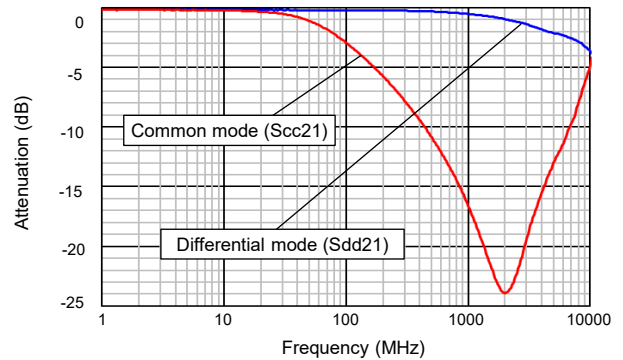

■ As for packaging methods, soldering conditions and safety precautions, please see data files

Common Mode Noise Filters

EXCX4CE type



Features

- Small and thin (L 0.65 mm×W 0.50 mm×H 0.30 mm)
- Noise suppression of high-speed differential transmission lines with little influence of waveform rounding on signal transmission
- Strong multilayer/sintered structure, excellent reflow resistance and high mounting reliability
- Lead, halogen and antimony-free
- RoHS compliant

Recommended applications

- Smartphones, Tablet PCs and DSC
- Noise suppression of high-speed differential data lines such as MIPI, USB and LVDS

Explanation of part numbers

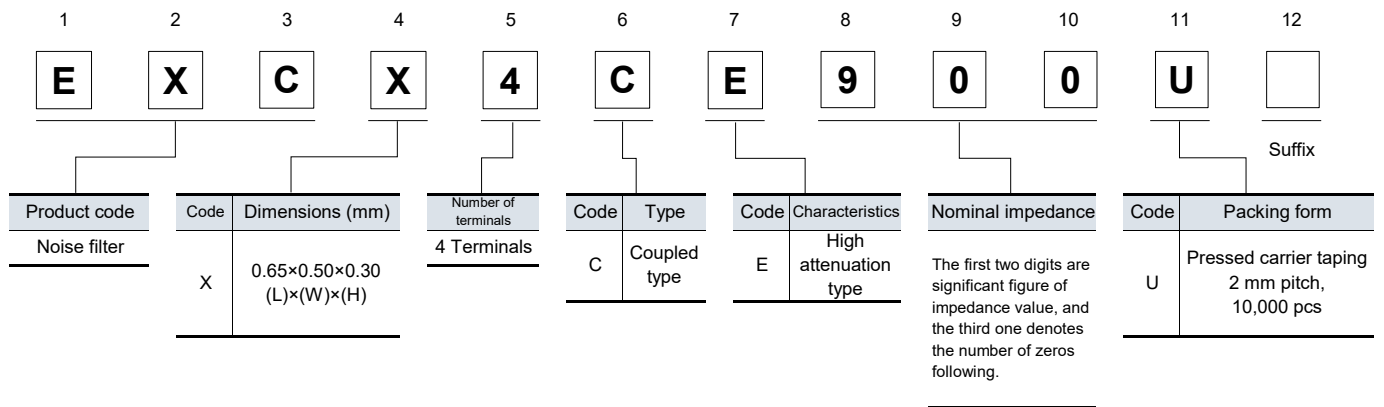

Construction

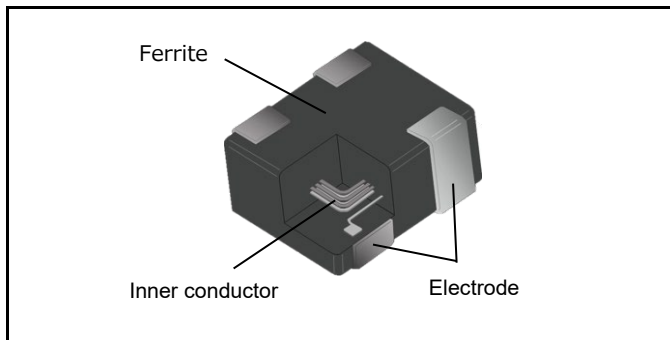

Circuit configuration (No polarity)

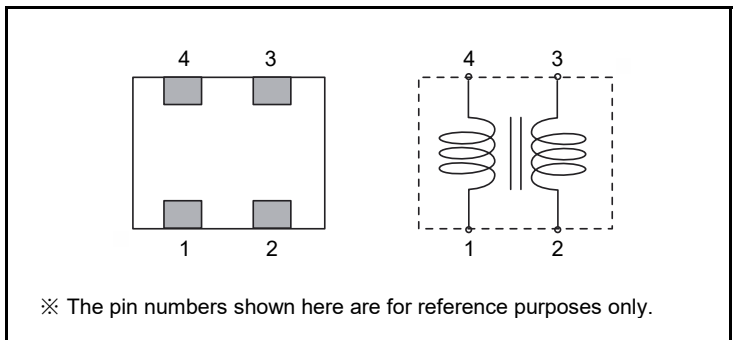

Dimensions in mm (not to scale)

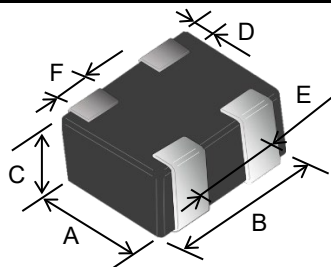

Unit : mm

Part No. (inch size)	Dimensions						Mass (Weight) (mg/ pc.)
	A	B	C	D	E	F	
EXCX4CE (0202)	0.50 ± 0.05	0.65 ± 0.05	0.30 ± 0.05	0.12 ± 0.10	0.40 ± 0.10	0.15 ± 0.10	0.56

Ratings

Part number	Impedance (Ω) at 100 MHz		Rated voltage (V) DC	Rated current (mA) DC	DC resistance (Ω)
	Common mode	Differential mode			
EXCX4CE600U	60 $\Omega \pm 20 \%$	18 Ω max.	5	100	2.4 $\pm 30 \%$
EXCX4CE900U	90 $\Omega \pm 20 \%$	20 Ω max.	5	100	3.0 $\pm 30 \%$

● Category temperature range $-40\text{ }^{\circ}\text{C}$ to $+85\text{ }^{\circ}\text{C}$

Impedance characteristics (Typical)

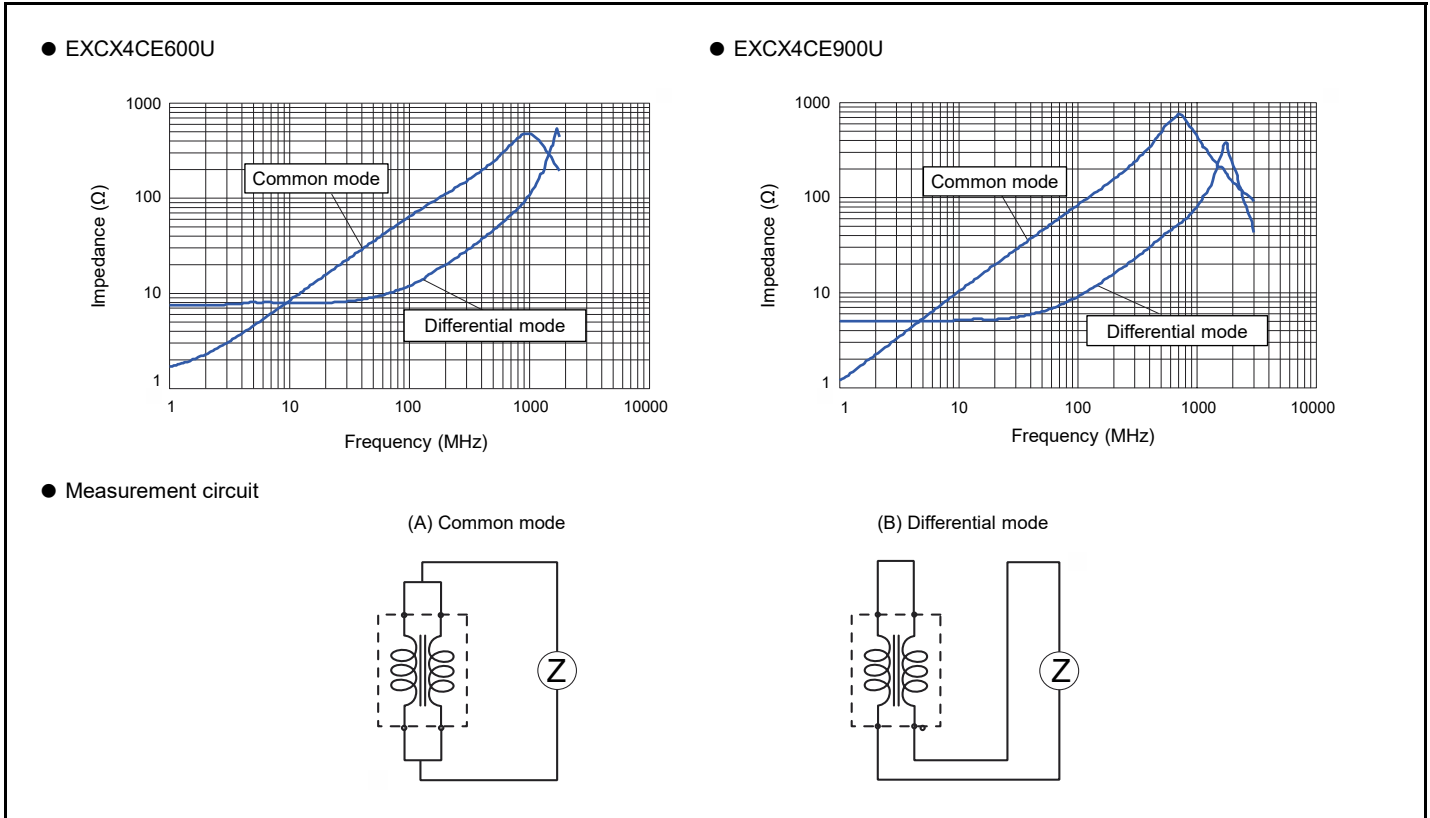

Common mode attenuation characteristics (Scc21), differential mode insertion loss characteristics (Sdd21) (reference data)

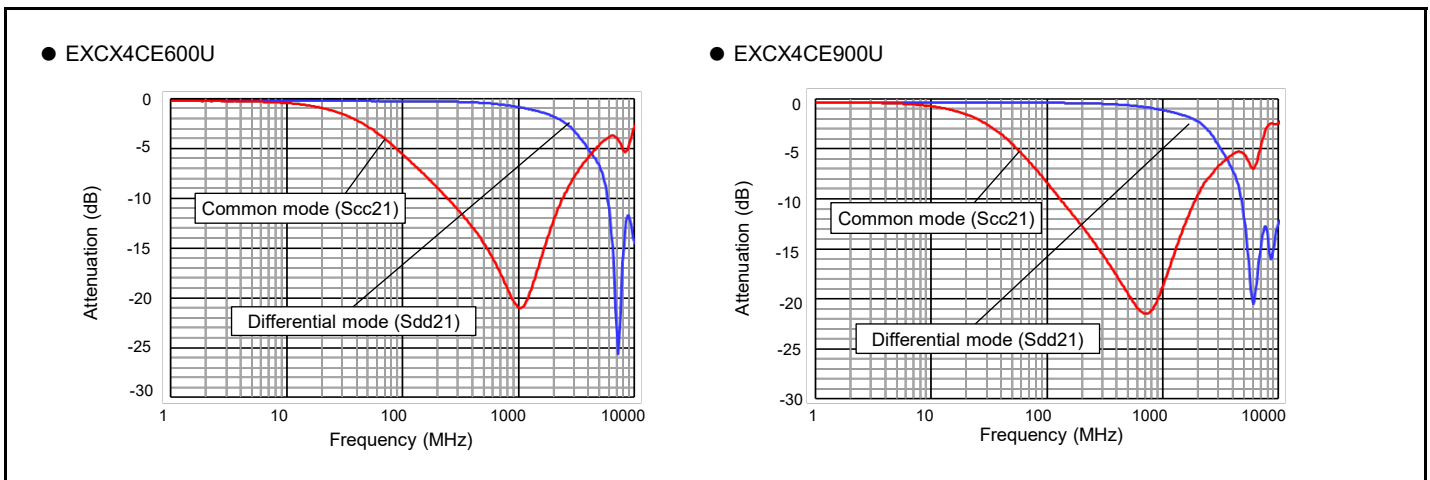

■ As for packaging methods, soldering conditions and safety precautions, please see data files



Common Mode Noise Filters

EXCX4CT type

Features

- Small and thin (L 0.65 mm×W 0.50 mm×H 0.30 mm)
- High attenuation at common-mode for noise suppression of harmonic signal components and cellular frequency
- Cut-off frequency is more than 3 GHz, the insertion loss is low in differential transmission line
- Strong multilayer/sintered structure, excellent reflow resistance and high mounting reliability
- RoHS compliant

Recommended applications

- Smartphones, Tablet PCs and DSC
- Noise suppression of high-speed differential data lines such as MIPI, USB and LVDS

Explanation of part numbers

1	2	3	4	5	6	7	8	9	10	11	12
E	X	C	X	4	C	T	9	0	0	X	
Product code Noise filter		Code X	Dimensions(mm) 0.65×0.50×0.30 (L)×(W)×(H)	Number of terminals 4 Terminals	Code C	Type Coupled type	Code T	Characteristics High attenuation type	Nominal impedance The first two digits are significant figure of impedance value, and the third one denotes the number of zeros following.	Code X	Packing form Pressed carrier taping 2 mm pitch, 10,000 pcs

Construction

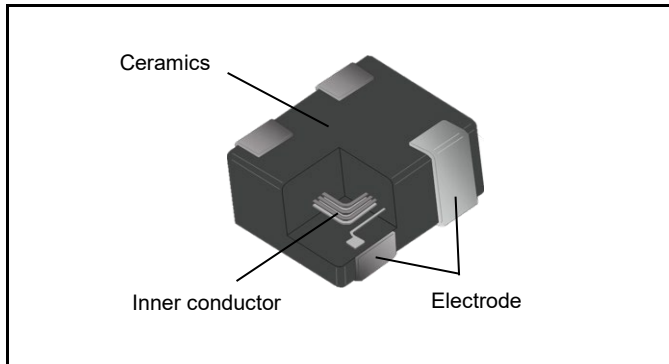

Circuit configuration (No polarity)

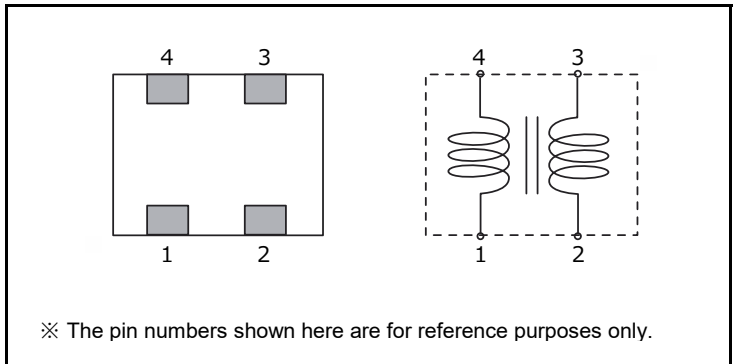

Dimensions in mm (not to scale)

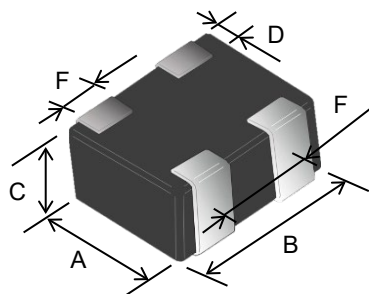

Unit : mm

Part No. (inch size)	Dimensions						Mass (Weight) (mg/ pc.)
	A	B	C	D	E	F	
EXCX4CT (0202)	0.50 ± 0.05	0.65 ± 0.05	0.30 ± 0.05	0.12 ± 0.10	0.40 ± 0.10	0.15 ± 0.10	0.43

Ratings

Part number	Impedance (Ω) at 100 MHz	Rated voltage (V) DC	Rated current (mA) DC	DC resistance (Ω) max.
	Common mode			
EXCX4CT650X	$65 \Omega \pm 20 \%$	10	100	$2.7 \Omega \pm 30 \%$
EXCX4CT900X	$90 \Omega \pm 20 \%$	10	100	$3.0 \Omega \pm 30 \%$

● Category temperature range $-40\text{ }^{\circ}\text{C}$ to $+85\text{ }^{\circ}\text{C}$

Impedance characteristics (Typical)

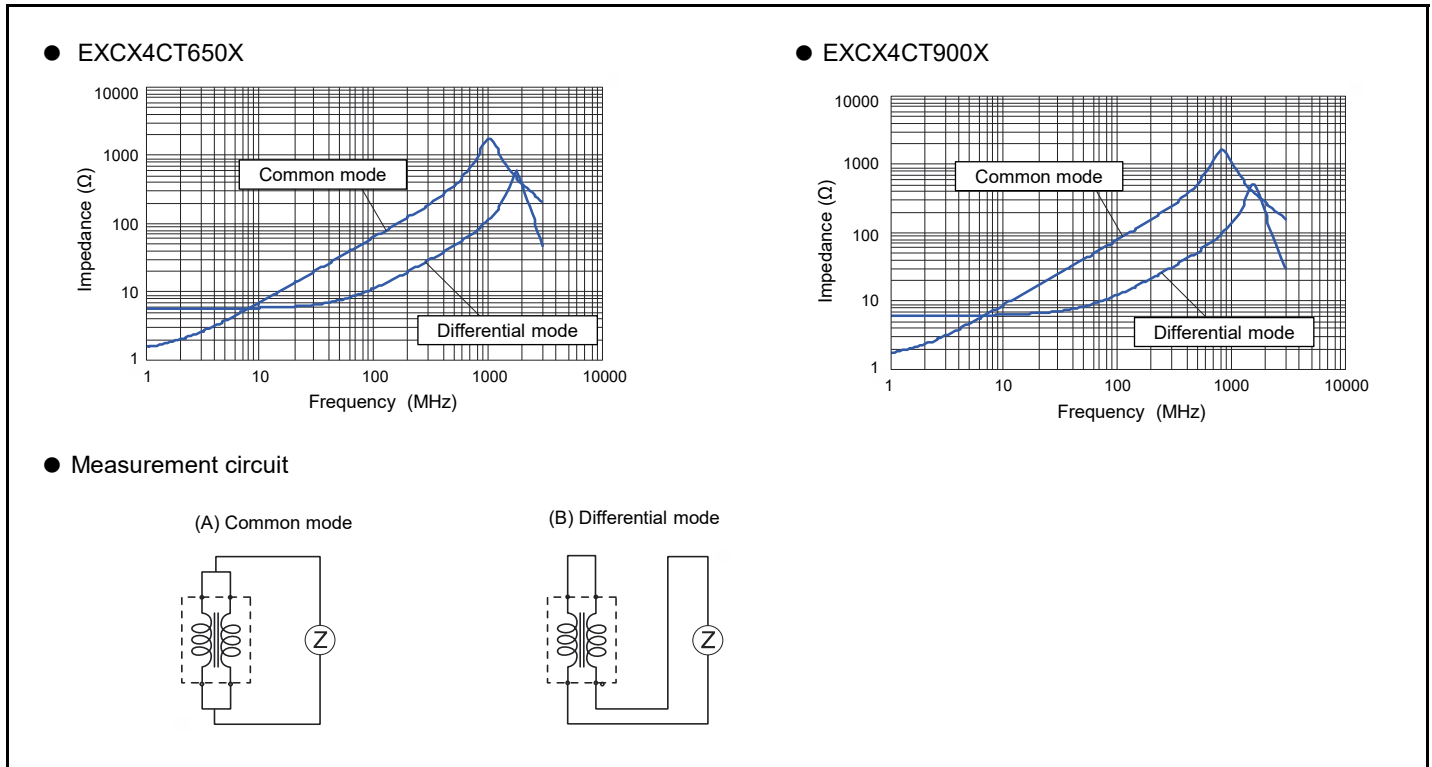

Insertion loss (Typical)

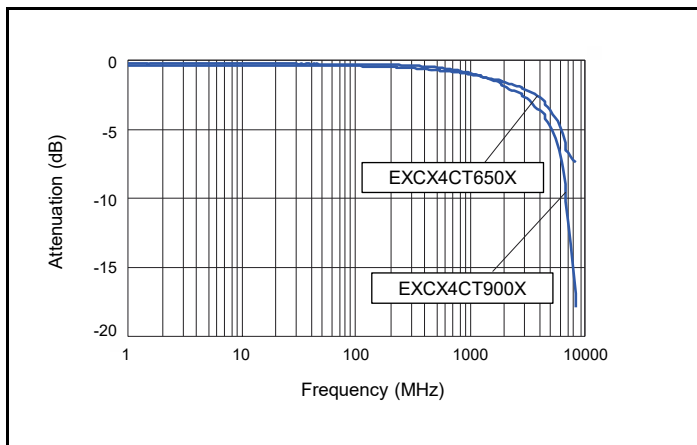

Common mode attenuation characteristics (Typical)

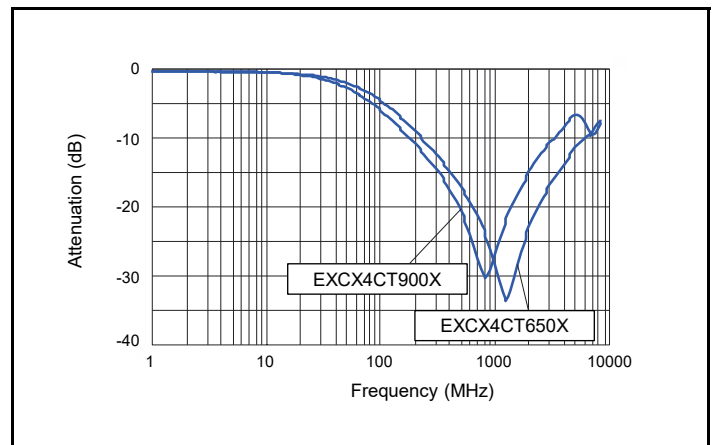

■ As for packaging methods, soldering conditions and safety precautions, please see data files

Common Mode Noise Filters

EXC14CH type

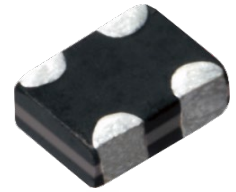

Features

- Small and thin (L 0.85 mm×W 0.65 mm×H 0.45 mm)
- High common mode attenuation in high-speed differential transmission lines, Cut-off frequency is more than 8.5 GHz, and an influence to differential transmission signal quality is little
- Strong multilayer/sintered structure, excellent reflow resistance and high mounting reliability
- RoHS compliant

Recommended applications

- Smartphones, Tablet PCs and DSC
- Noise suppression of high-speed differential data lines such as USB, LVDS and HDMI

Explanation of part numbers

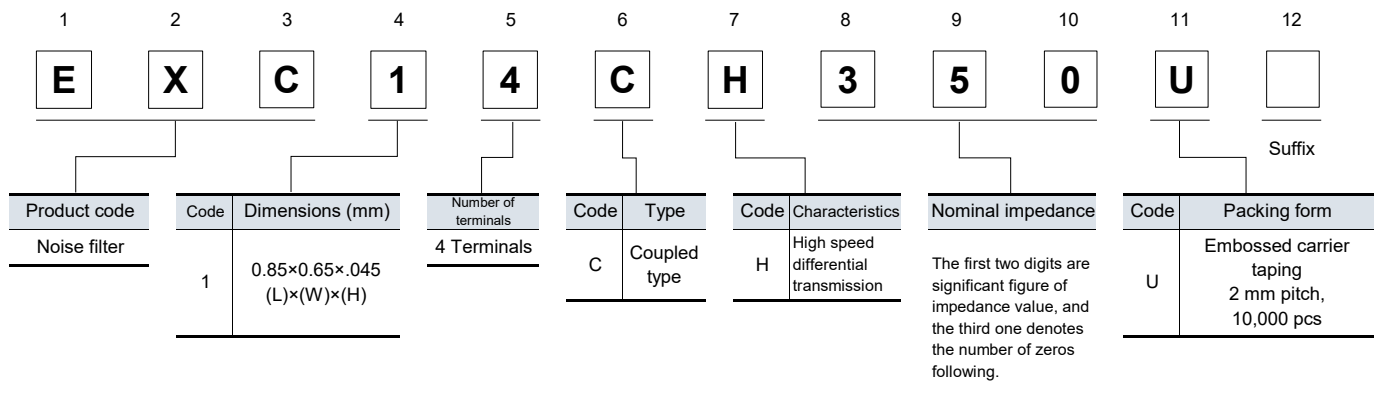

Construction

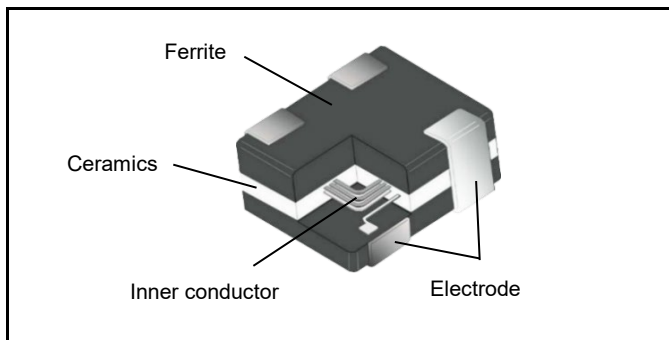

Circuit configuration (No polarity)

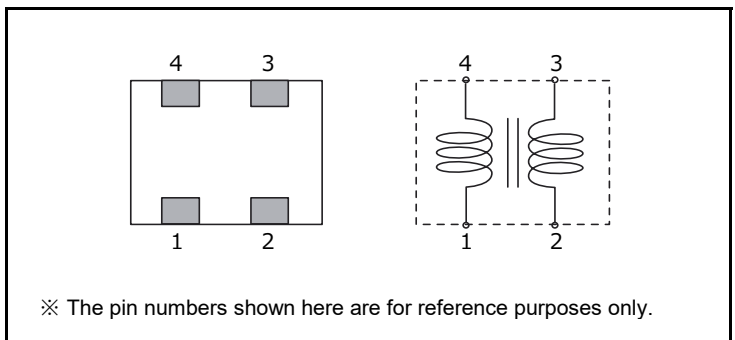

Dimensions in mm (not to scale)

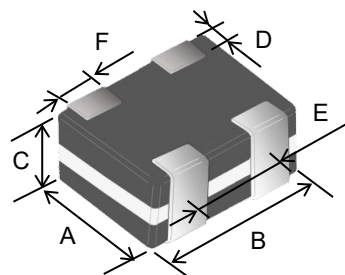

Unit : mm

Part No. (inch size)	Dimensions						Mass (Weight) (mg/ pc.)
	A	B	C	D	E	F	
EXC14CH (0302)	0.65 ± 0.05	0.85 ± 0.05	0.45 ± 0.05	0.10 min.	0.50 ± 0.10	0.27 ± 0.10	1.0

Ratings

Part number	Impedance (Ω) at 100 MHz		Rated voltage (V) DC	Rated current (mA) DC	DC resistance (Ω) max.
	Common mode	Differential mode			
EXC14CH120U	12 Ω \pm 25 %	10 Ω max.	5	100	1.0
EXC14CH350U	35 Ω \pm 30 %	15 Ω max.	5	100	1.5

● Category temperature range $-40\text{ }^{\circ}\text{C}$ to $+85\text{ }^{\circ}\text{C}$

Impedance characteristics (Typical)

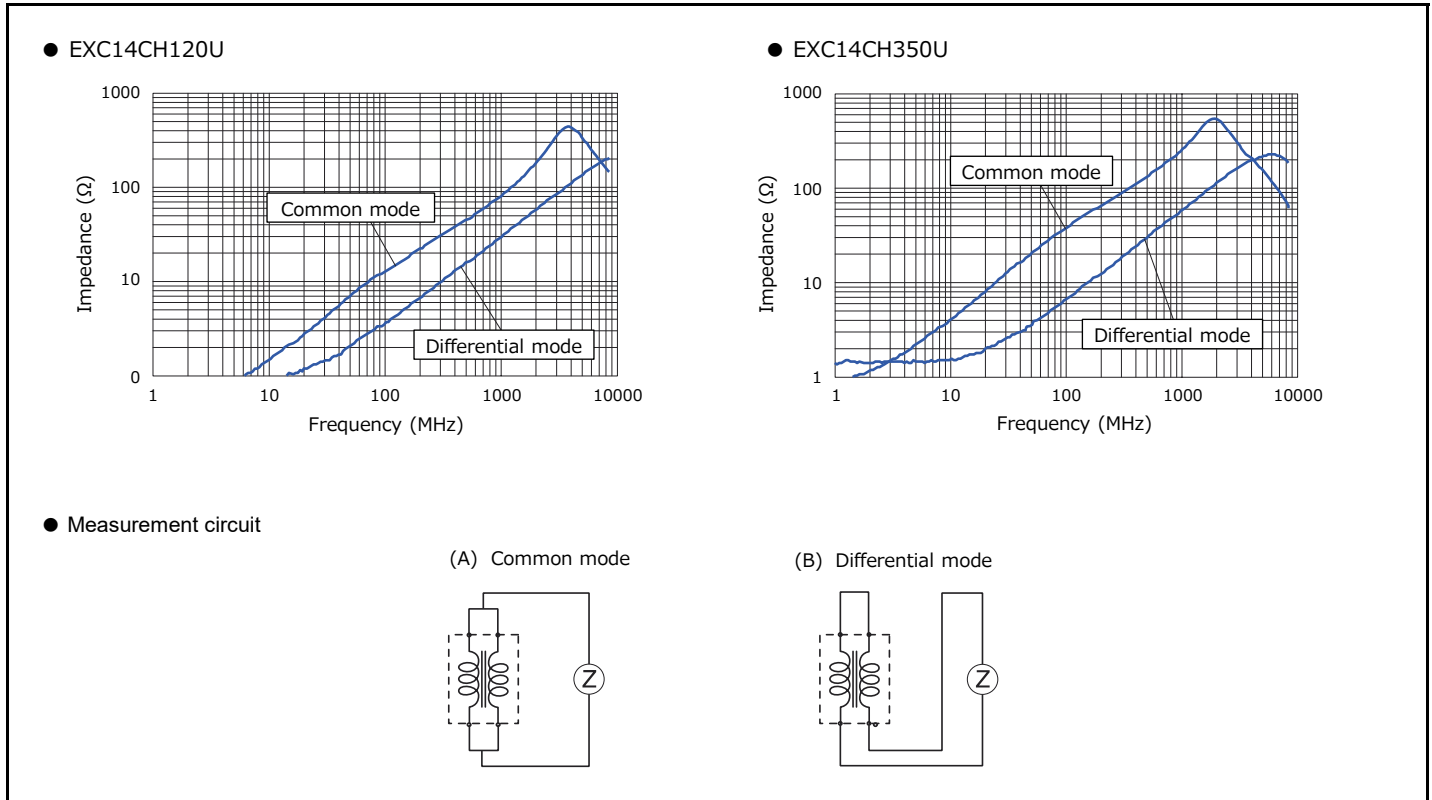

Insertion loss (Typical)

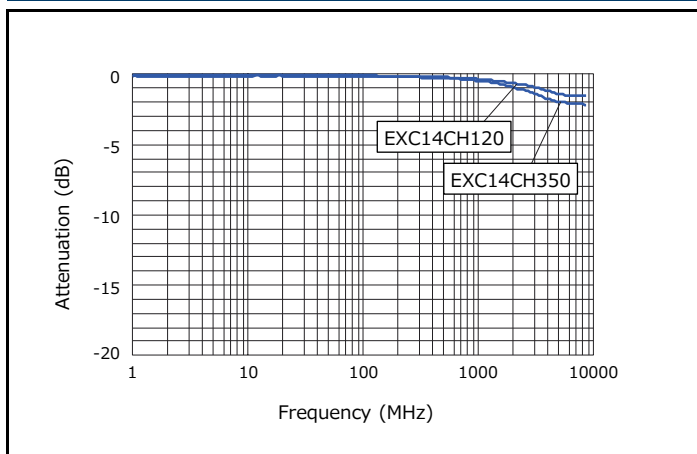

Common mode attenuation characteristics (Typical)

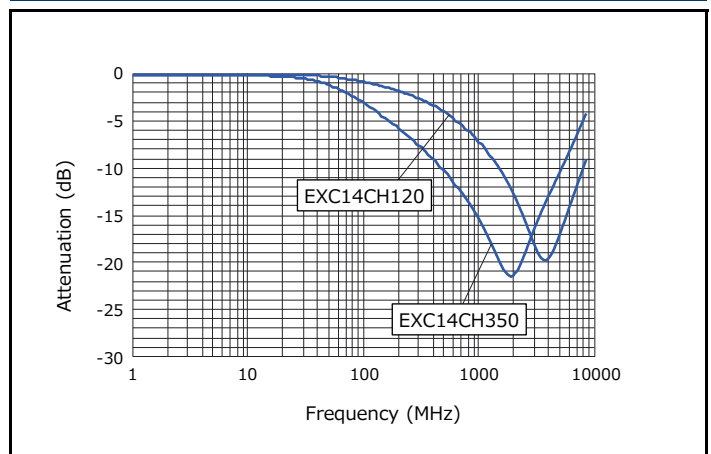

■ As for packaging methods, soldering conditions and safety precautions, please see data files

Common Mode Noise Filters

EXC14CG/CE type



Features

- Small and thin (L 0.85 mm×W 0.65 mm×H 0.45 mm)
- Noise suppression of high-speed differential transmission lines with little influence of waveform rounding on signal transmission
- Low DC resistance and low insertion loss
- High-Q value and high impedance of GHz zone : EXC14CG type
- Strong multilayer/sintered structure, excellent reflow resistance and high mounting reliability
- RoHS compliant

Recommended applications

- Smartphones, Tablet PCs and DSC
- Noise suppression of high-speed differential data lines such as USB, LVDS and MHL

Explanation of part numbers

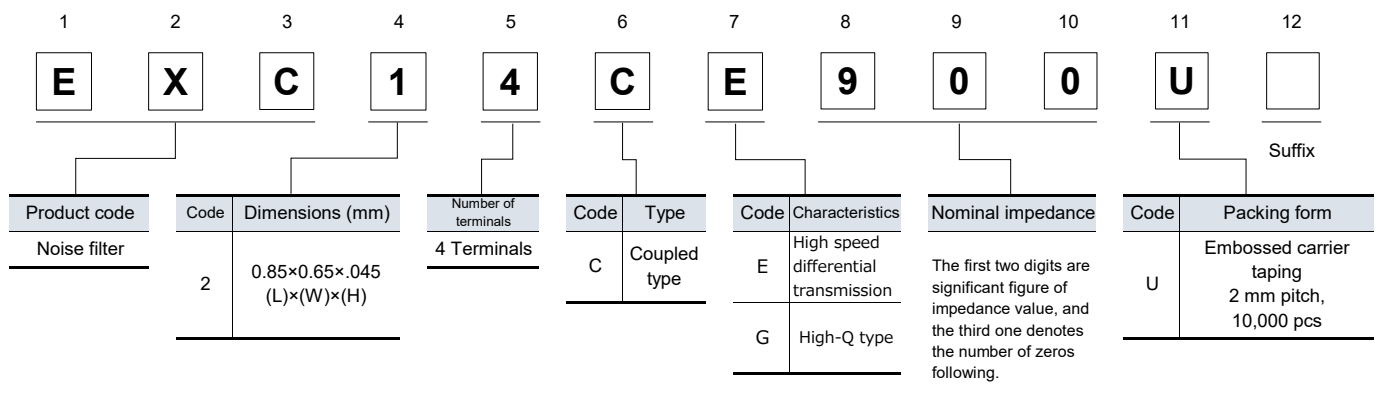

Construction

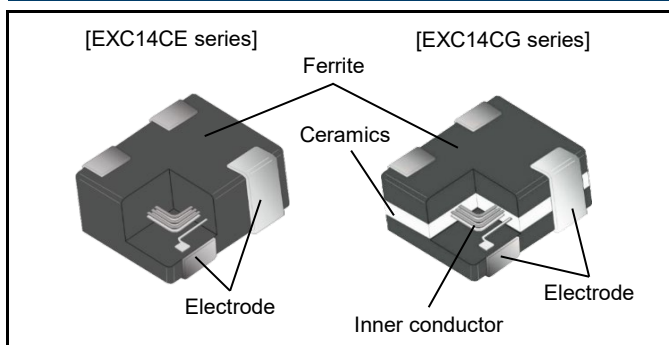

Circuit configuration (No polarity)

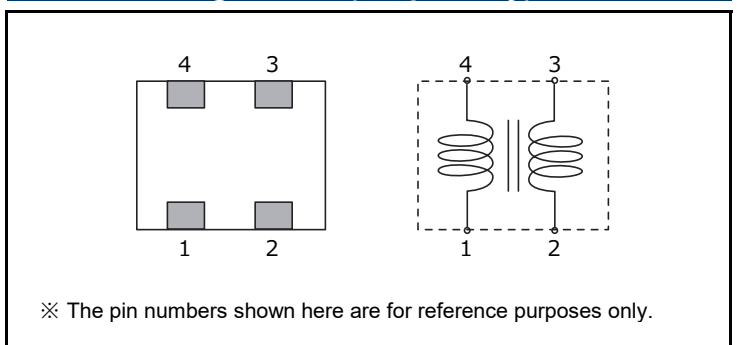

Dimensions in mm (not to scale)

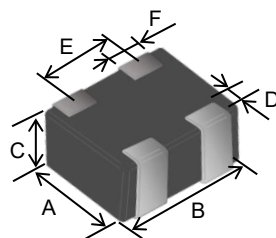

Part No. (inch size)	Dimensions						Mass (Weight) (mg/ pc.)
	A	B	C	D	E	F	
EXC14CG(0302) EXC14CE(0302)	0.65 ± 0.05	0.85 ± 0.05	0.45 ± 0.05	0.10 min.	0.50 ± 0.10	0.27 ± 0.10	1.4

Unit : mm

Ratings

Part number	Impedance (Ω) at 100 MHz		Rated voltage (V) DC	Rated current (mA) DC	DC resistance (Ω) max.
	Common mode	Differential mode			
EXC14CG120U	12 \pm 30 %	10 max.	5	130	2.0
EXC14CG350U	35 \pm 30 %	15 max.	5	100	2.0
EXC14CG430U	43 \pm 25 %	15 max.	5	100	2.7
EXC14CE650U	65 \pm 20 %	20 max.	5	130	2.5
EXC14CE900U	90 \pm 20 %	20 max.	5 </td <td>130</td> <td>2.5</td>	130	2.5
EXC14CE121U	120 \pm 20 %	20 max.	5	100	3.8

● Category temperature range $-40\text{ }^{\circ}\text{C}$ to $+85\text{ }^{\circ}\text{C}$

Impedance characteristics (Typical)

● EXC14CG120U

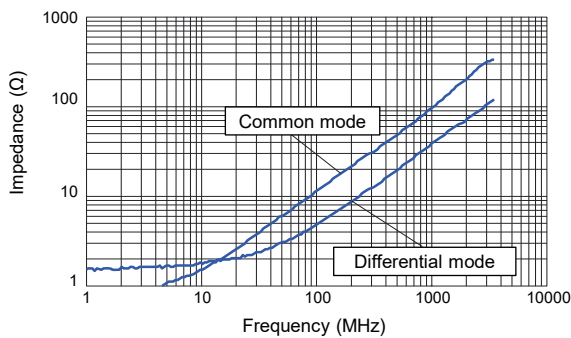

● EXC14CG350U

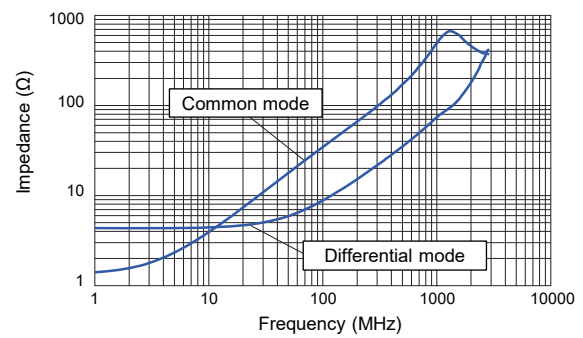

● EXC14CG430U

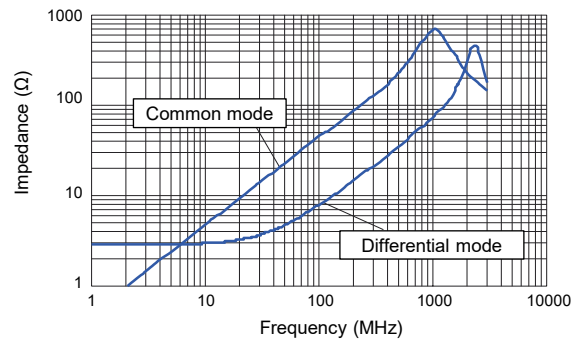

● EXC14CE650U

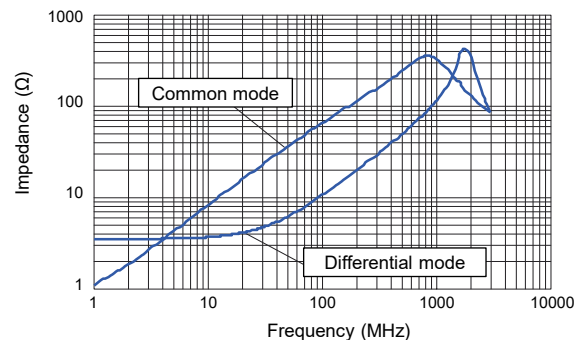

● EXC14CE900U

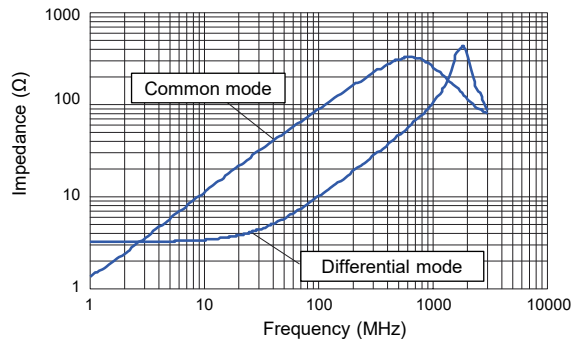

● EXC14CE121U

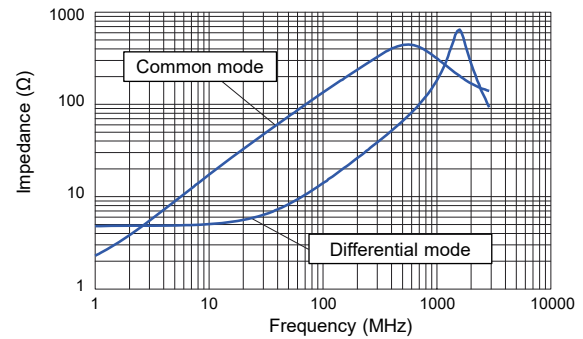

● Measurement circuit

(A) Common mode

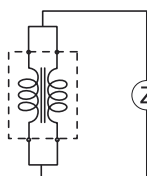

(B) Differential mode

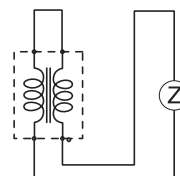

Attenuation characteristics (Typical)

● EXC14CG120U

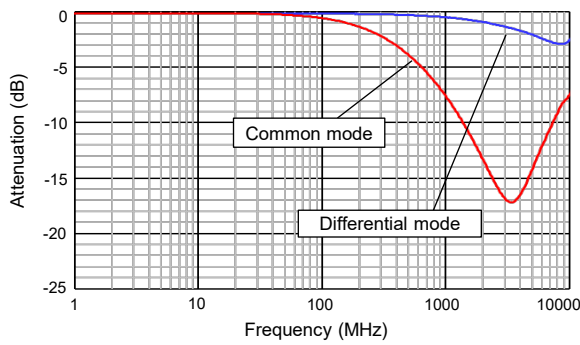

● EXC14CG350U

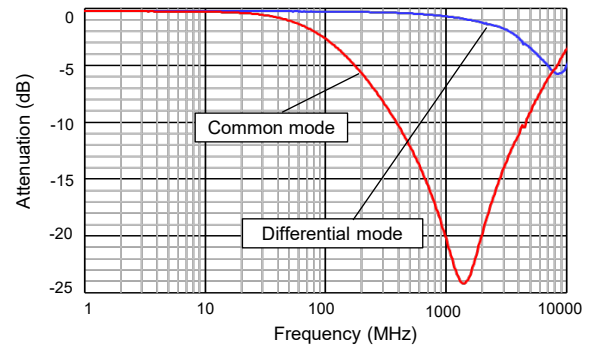

● EXC14CG430U

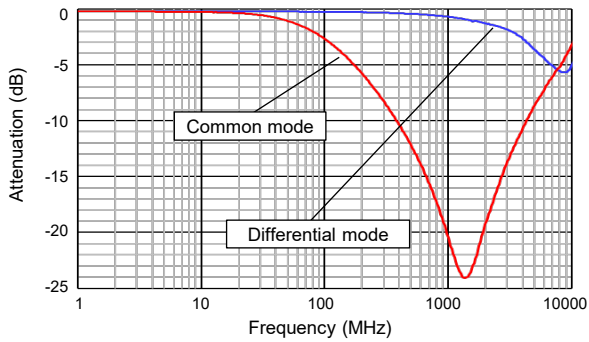

● EXC14CE650U

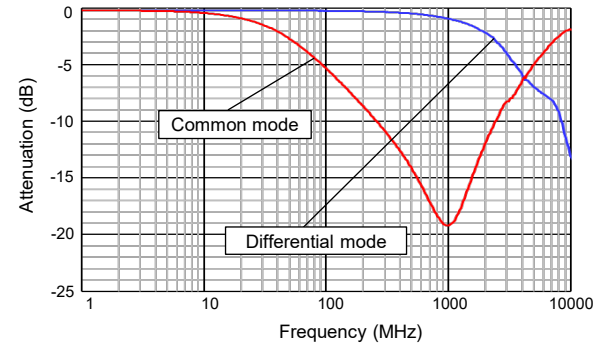

● EXC14CE900U

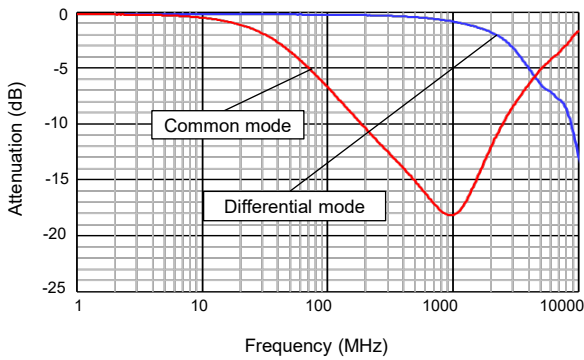

● EXC14CE121U

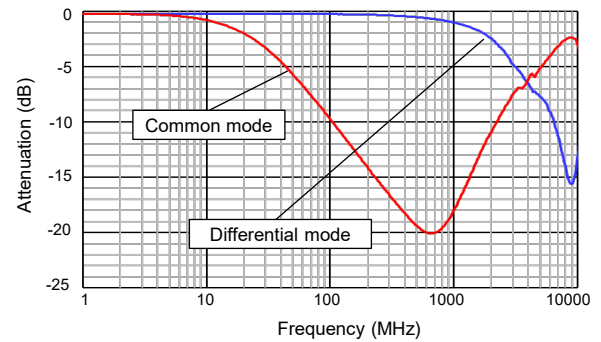

■ As for packaging methods, soldering conditions and safety precautions, please see data files

Common Mode Noise Filters

EXC14CT type

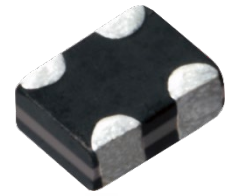

Features

- Small and thin (L 0.85 mm×W 0.65 mm×H 0.45 mm)
- High attenuation at common-mode for noise suppression of harmonic signal components and cellular frequency
- High cut-off frequency and capability of coping with high-speed signals (HDMI)
- Strong multilayer/sintered structure, excellent reflow resistance and high mounting reliability
- RoHS compliant

Recommended applications

- Smartphones, Tablet PCs and DSC
- Noise suppression of high-speed differential data lines such as MIPI, LVDS

Explanation of part numbers

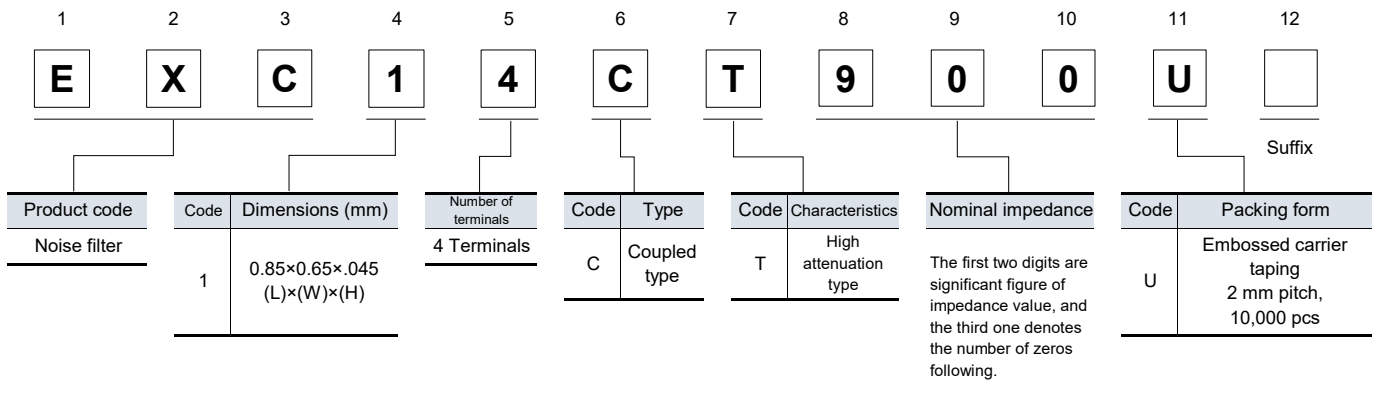

Construction

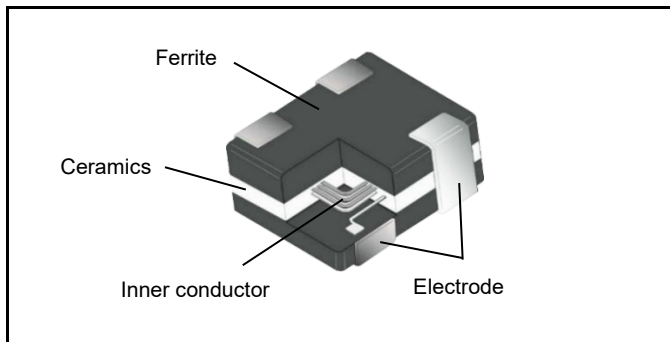

Circuit configuration (No polarity)

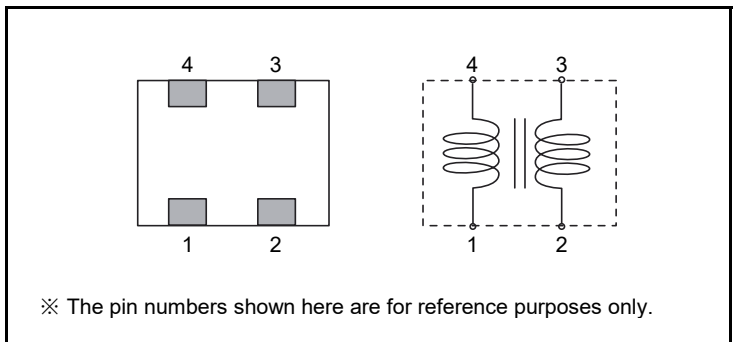

Dimensions in mm (not to scale)

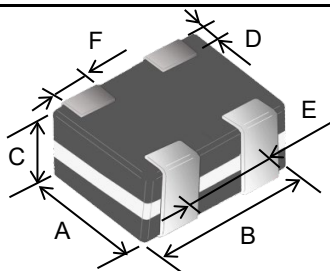

Unit : mm

Part No. (inch size)	Dimensions						Mass (Weight) (mg/ pc.)
	A	B	C	D	E	F	
EXC14CT (0302)	0.65 ± 0.05	0.85 ± 0.05	0.45 ± 0.05	0.10 min.	0.50 ± 0.10	0.27 ± 0.10	1.0

Ratings

Part number	Impedance (Ω) at 100 MHz		Rated voltage (V) DC	Rated current (mA) DC	DC resistance (Ω)
	Common mode	Differential mode			
EXC14CT500U	50 $\Omega \pm 25 \%$	17 Ω max.	5	100	2.3 $\Omega \pm 30 \%$
EXC14CT900U	90 $\Omega \pm 20 \%$	20 Ω max.	5	100	3.3 $\Omega \pm 30 \%$

● Category temperature range $-40\text{ }^{\circ}\text{C}$ to $+85\text{ }^{\circ}\text{C}$

Impedance characteristics (Typical)

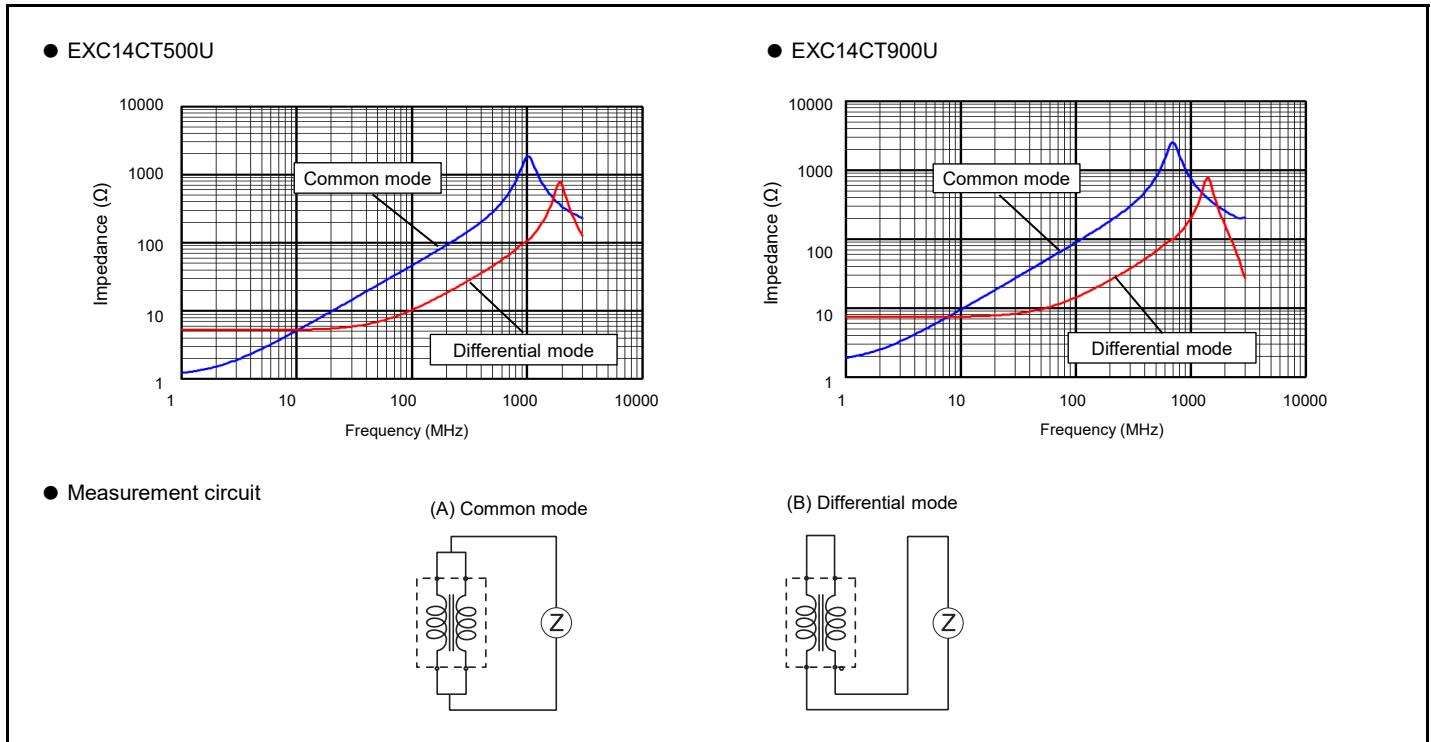

Common mode attenuation characteristics (Scc21), differential mode insertion loss characteristics (Sdd21) (reference data)

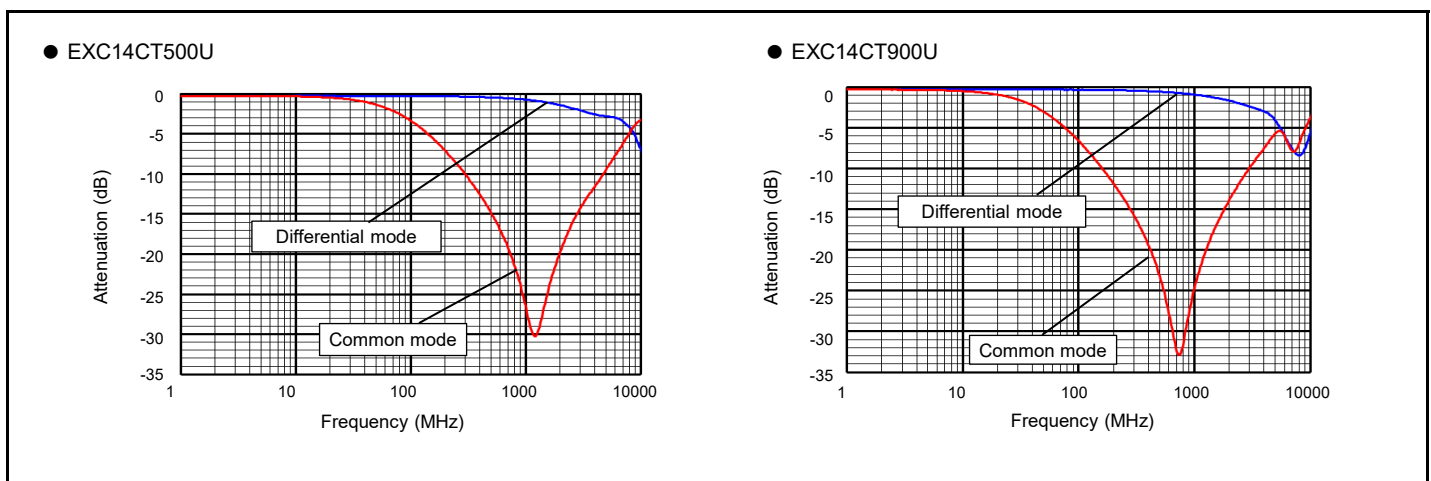

■ As for packaging methods, soldering conditions and safety precautions, please see data files

Common Mode Noise Filters

EXC14CX type



Features

- Small and thin (L 0.85 mm×W 0.65 mm×H 0.45 mm)
- Effective noise suppression of smartphones by eliminating common mode noises and removing differential signal components
- Strong multilayer/sintered structure, excellent reflow resistance and high mounting reliability
- RoHS compliant

Recommended applications

- Smartphones, Tablet PCs and DSC
- Noise suppression of high-speed differential data lines such as MIPI, USB and LVDS

Explanation of part numbers

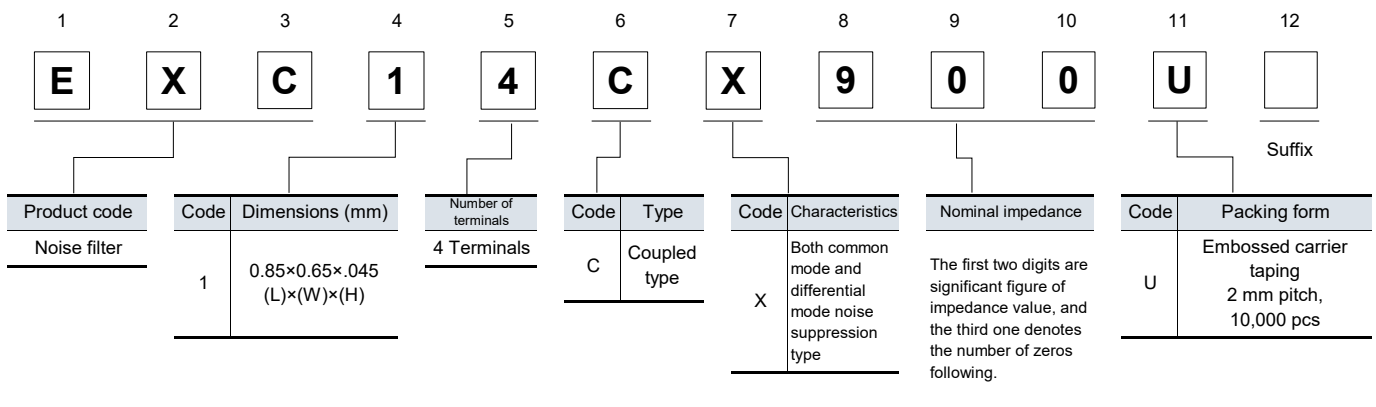

Construction

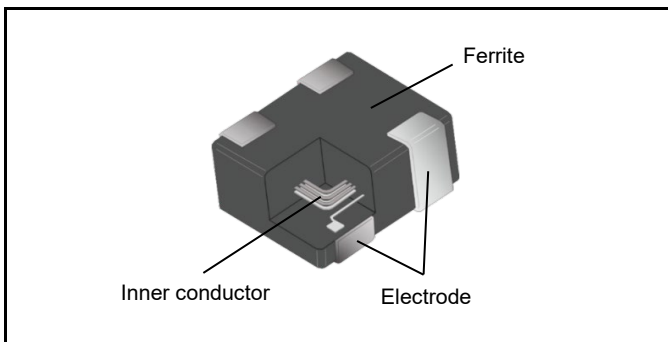

Circuit configuration (No polarity)

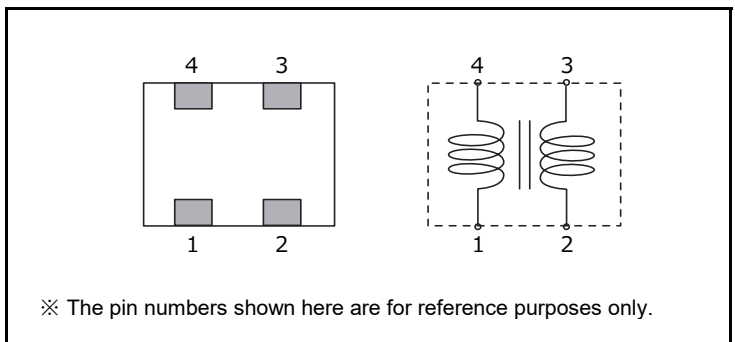

Dimensions in mm (not to scale)

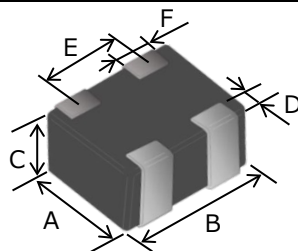

Unit : mm

Part No. (inch size)	Dimensions						Mass (Weight) (mg/ pc.)
	A	B	C	D	E	F	
EXC14CX (0302)	0.65 ± 0.05	0.85 ± 0.05	0.45 ± 0.05	0.10 min.	0.50 ± 0.10	0.27 ± 0.10	1.4

Ratings

Part number	Impedance (Ω) at 100 MHz		Rated voltage (V) DC	Rated current (mA) DC	DC resistance (Ω) max.
	Common mode	Differential mode			
EXC14CX280U	28 $\Omega \pm 25\%$	25 Ω max.	5	100	3.0
EXC14CX400U	40 $\Omega \pm 25\%$	30 Ω max.	5	100	4.0

● Category temperature range $-40\text{ }^{\circ}\text{C}$ to $+85\text{ }^{\circ}\text{C}$

Impedance characteristics (Typical)

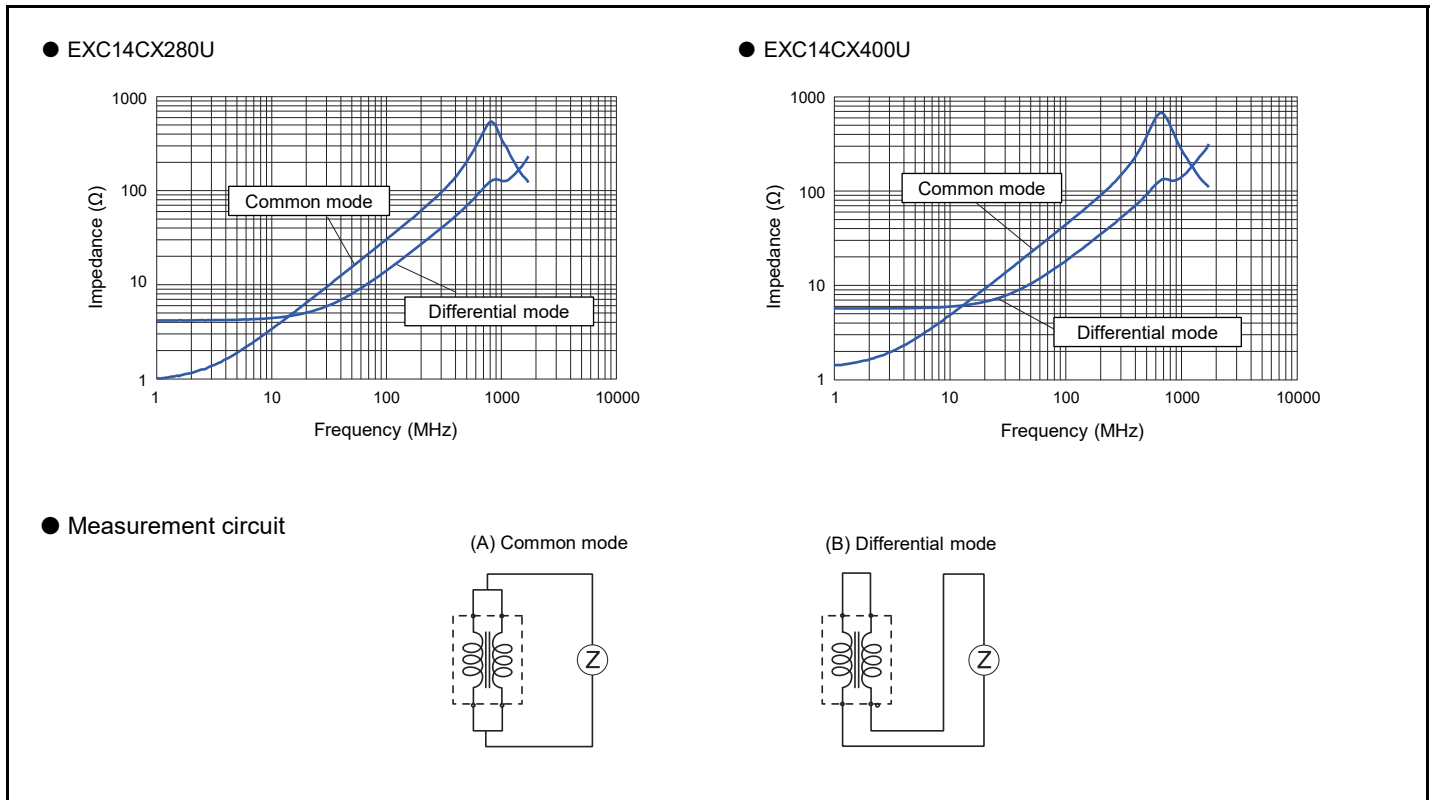

Attenuation characteristics (Typical)

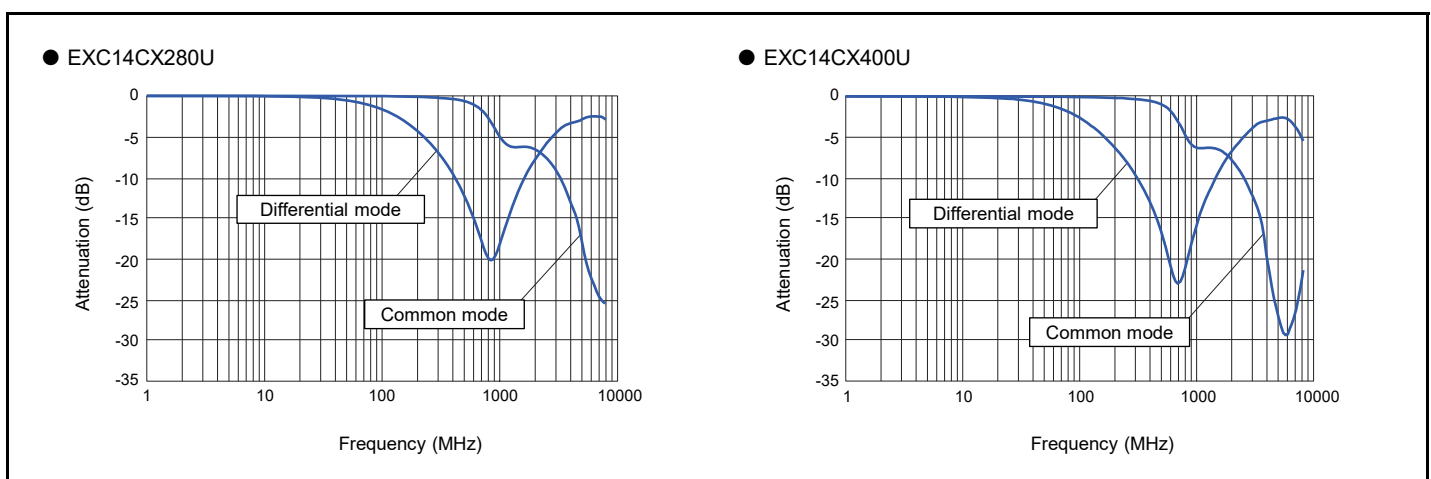

■ As for packaging methods, soldering conditions and safety precautions, please see data files



Common Mode Noise Filters

EXC16CT type

Features

- Corresponding to new high-speed differential interface (MIPI C-PHY)
Corresponding to 3-line transmission, transmission rate up to 2.5 Gbps
- Unique plating fine coil process and ceramic multilayer process enable compact size
(L 0.90 × W 0.68 × H 0.40 mm)
around 40% reduction of mounting area (comparing with MIPI D-PHY)
- Strong multilayer/sintered structure, excellent reflow resistance and high mounting reliability
- Lead, halogen and antimony-free
- RoHS compliant

Recommended applications

- High resolution camera and display equipped mobile devices (Smartphones, Tablet PCs and wearable)
- Noise suppression of high-speed differential data lines such as MIPI C-PHY

Explanation of part numbers

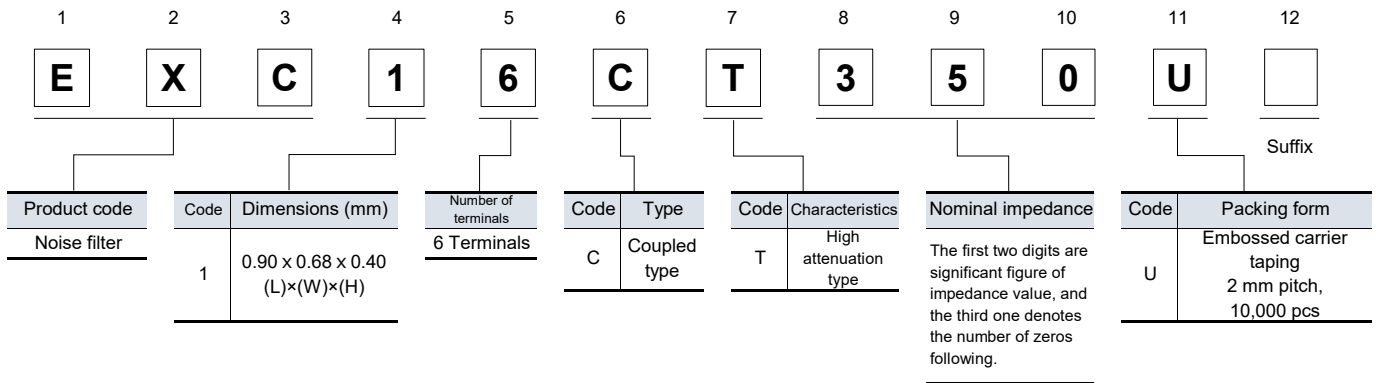

Construction

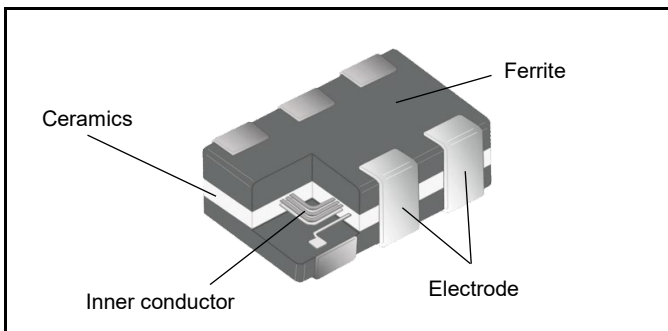

Circuit configuration (No polarity)

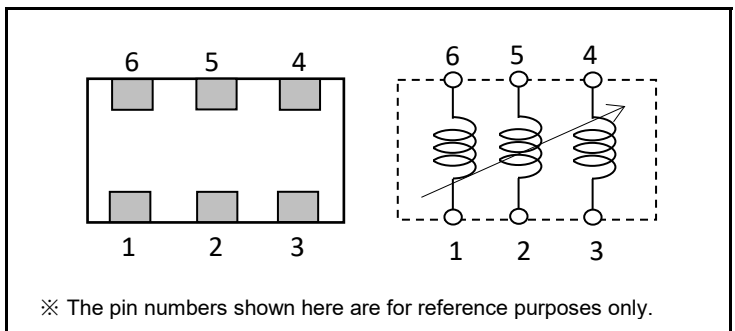

Dimensions in mm (not to scale)

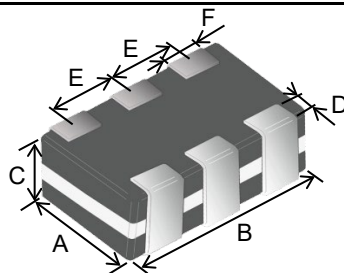

Unit : mm

Part No. (inch size)	Dimensions						Mass (Weight) (mg/ pc.)
	A	B	C	D	E	F	
EXC16CT (0403)	0.68 ± 0.05	0.90 ± 0.05	0.40 ± 0.05	0.125 ± 0.075	0.35 ± 0.05	0.165 ± 0.065	1.1

Ratings

Part number	Impedance (Ω) at 100 MHz	Rated voltage (V) DC	Rated current (mA) DC	DC resistance (Ω) max.
	Common mode			
EXC16CT250U	25 $\Omega \pm 25\%$	5	100	3.0
EXC16CT350U	35 $\Omega \pm 30\%$	5	100	4.0

● Category temperature range $-40\text{ }^{\circ}\text{C}$ to $+85\text{ }^{\circ}\text{C}$

Impedance characteristics (Typical)

● EXC16CT250U

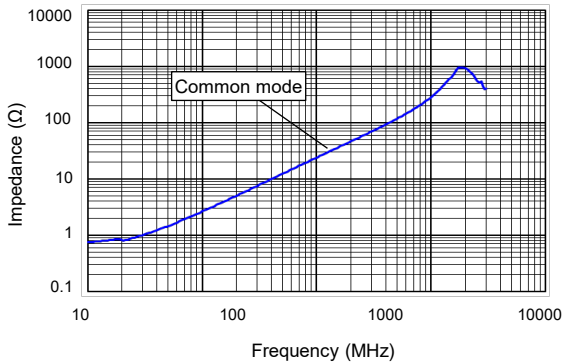

● EXC16CT350U

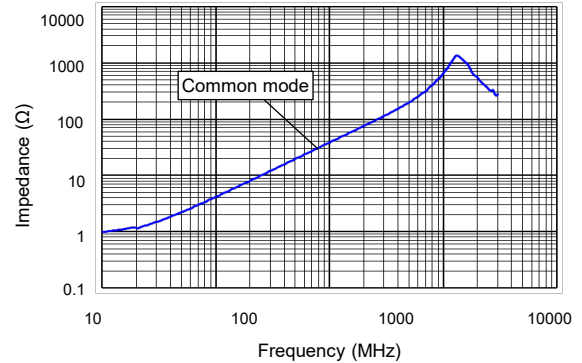

● Measurement circuit

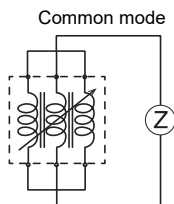

Common mode attenuation characteristics (Scc21), differential mode insertion loss characteristics (Sdd21) (reference data)

● EXC16CT250U

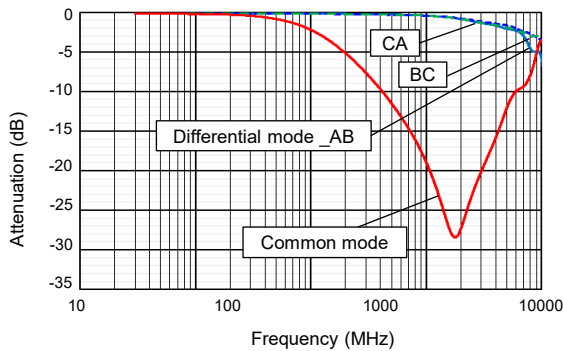

● EXC16CT350U

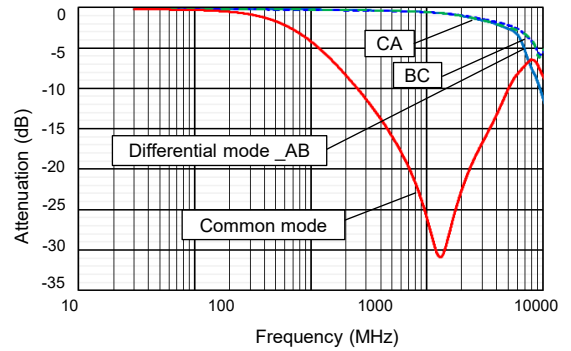

● Measurement circuit

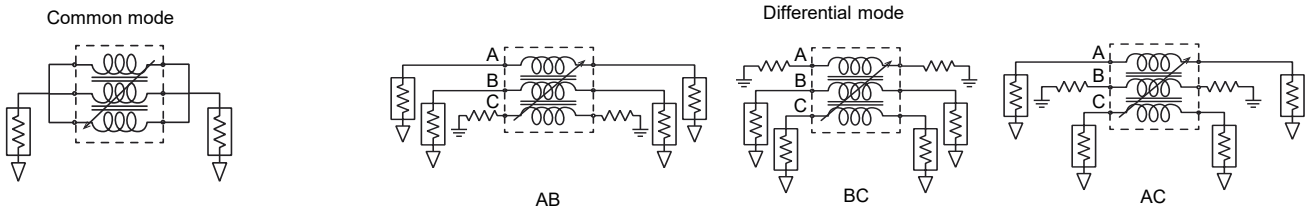

■ As for packaging methods, soldering conditions and safety precautions, please see data files

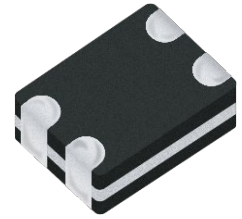

Common Mode Noise Filters

EXC24CK type

Features

- Small and thin type, built-in filter circuit (L 1.25 mm×W 1.00 mm×H 0.50 mm)
- Since the cut-off frequency (of the CMNF) is so high, high frequency noise are suppressed without signal integrity degradation.
- Strong multilayer/sintered structure, excellent reflow resistance and high mounting reliability
- RoHS compliant

Recommended applications

- AV equipment (LCD-TV, DVD/Blu-ray drives), Information equipment (PCs, HDD), Communications equipment (Mobile phones, Smartphones)
- Noise suppression for high-speed differential data lines of information devices such as PCs equipped with USB3.2, HDMI, SATA, Display Port, etc.

Explanation of part numbers

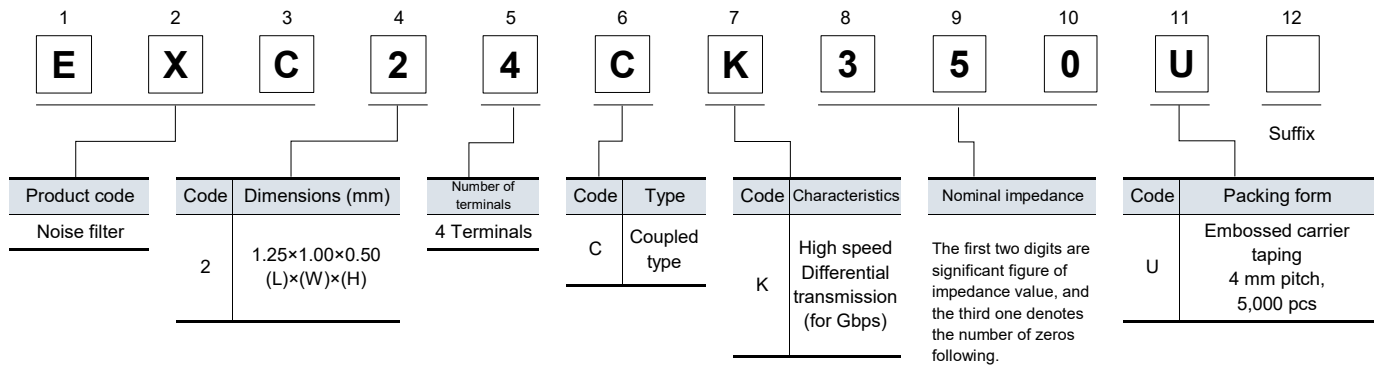

Construction

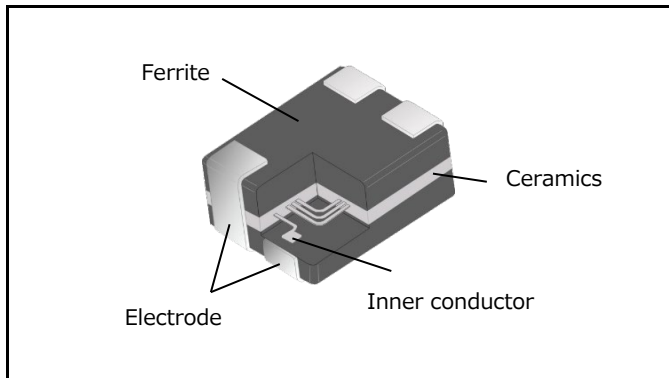

Circuit configuration (No polarity)

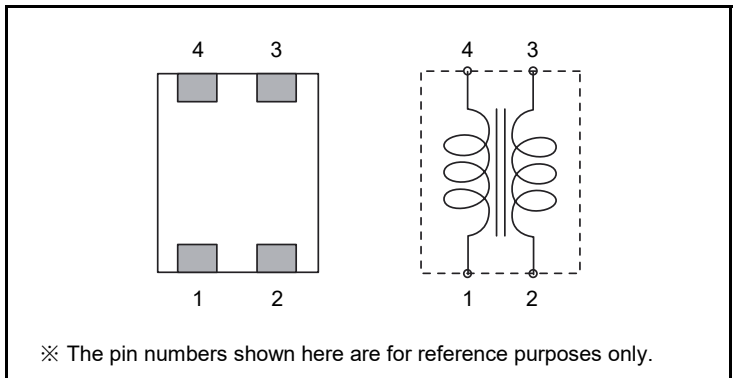

Dimensions in mm (not to scale)

Part No. (inch size)	Dimensions						Mass (Weight) (mg/ pc.)
	A	B	C	D	E	F	
EXC24CK (0504)	1.25 ± 0.15	1.00 ± 0.15	0.50 ± 0.10	0.20 ± 0.15	0.55 ± 0.10	0.30 ± 0.10	2.1

Unit : mm

Ratings

Part number	Impedance (Ω) at 100 MHz		Cutoff frequency (GHz)	Rated voltage (V) DC	Rated current (mA) DC	DC resistance (Ω) max.
	Common mode	Differential mode				
EXC24CK350U	35 Ω \pm 30 %	13 Ω max.	10 Typ.	5	160	1.5

● Category temperature range $-40\text{ }^{\circ}\text{C}$ to $+85\text{ }^{\circ}\text{C}$

Impedance characteristics (Typical)

● EXC24CK350U

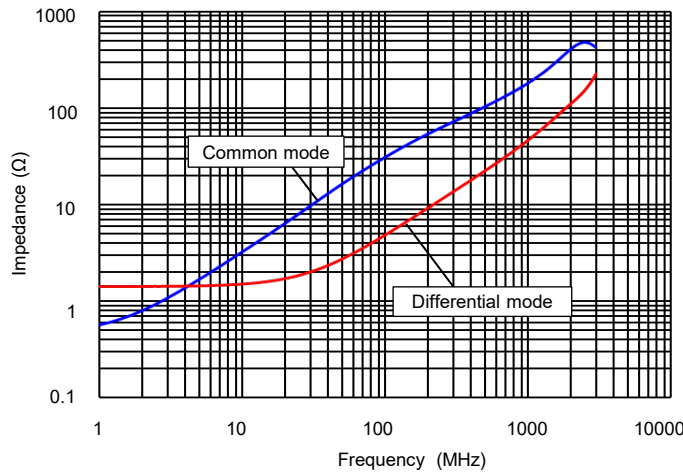

● Measurement circuit

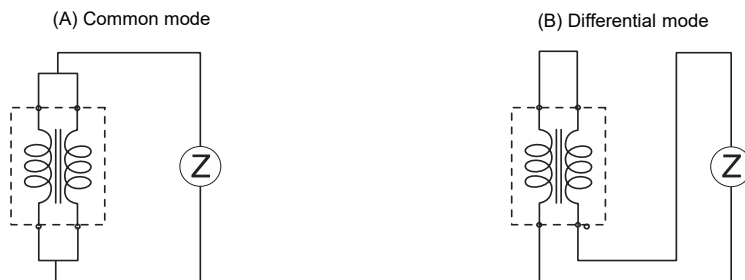

Common mode attenuation characteristics (Scc21), differential mode insertion loss characteristics (Sdd21) (reference data)

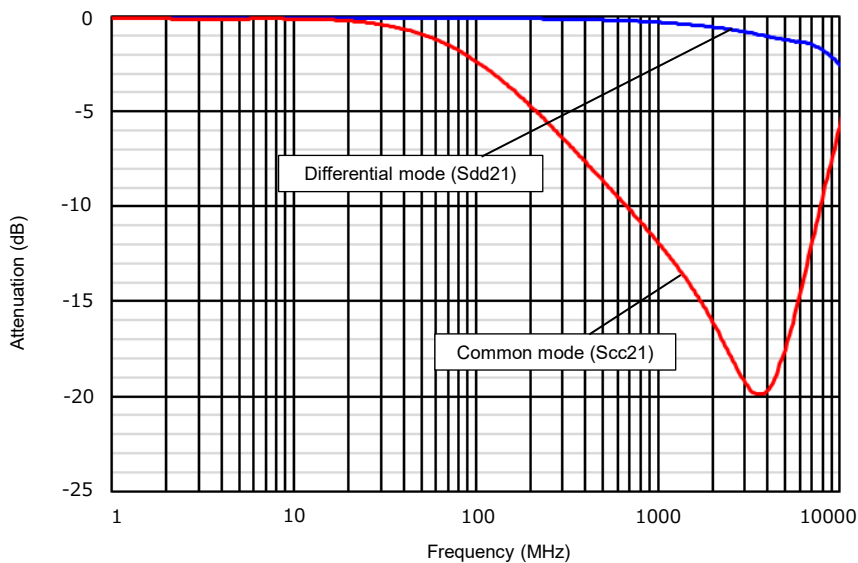

■ As for packaging methods, soldering conditions and safety precautions, please see data files

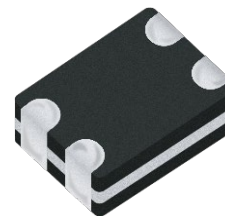

Common Mode Noise Filters

EXC24CH type

Features

- Small and thin type, built-in filter circuit (L 1.25 mm×W 1.00 mm×H 0.50 mm)
- Since the cut-off frequency (of the CMNF) is so high, high frequency noise are suppressed without signal integrity degradation.
- Strong multilayer/sintered structure, excellent reflow resistance and high mounting reliability
- RoHS compliant

Recommended applications

- AV equipment (LCD-TV, DVD/Blu-ray drives), Information equipment (PCs, HDD), Communications equipment (Mobile phones, Smartphones)
- Noise suppression of high-speed differential data lines such as USB 3.2, HDMI and Display Port

Explanation of part numbers

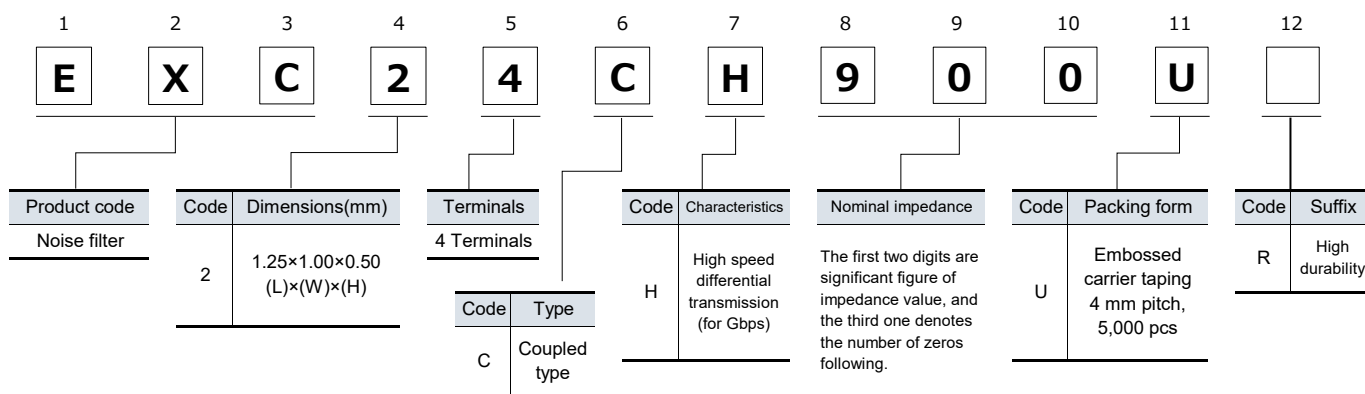

Construction

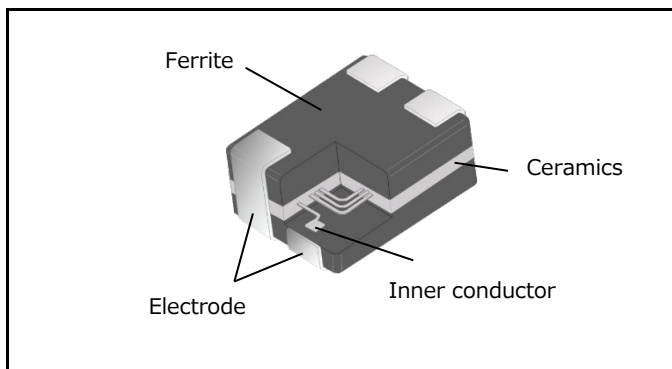

Circuit configuration (No polarity)

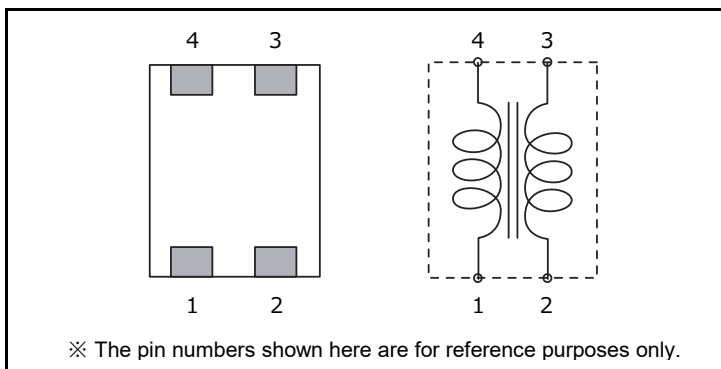

Dimensions in mm (not to scale)

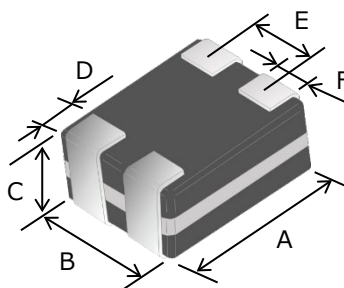

Part No. (inch size)	Dimensions						Mass (Weight) (mg/ pc.)
	A	B	C	D	E	F	
EXC24CH (0504)	1.25 ± 0.15	1.00 ± 0.15	0.50 ± 0.10	0.20 ± 0.15	0.55 ± 0.10	0.30 ± 0.10	2.4

Ratings

Part number	Impedance (Ω) at 100 MHz		Cutoff frequency (GHz)	Rated voltage (V) DC	Rated current (mA) DC	DC resistance (Ω) max.
	Common mode	Differential mode				
NEW EXC24CH500U/UR	50 $\Omega \pm 25 \%$	13 Ω max.	8 Typ.	5	160	1.5
NEW EXC24CH900U/UR	90 $\Omega \pm 20 \%$	15 Ω max.	5 Typ.	5	130	2.5

● Category temperature range $-40\text{ }^{\circ}\text{C}$ to $+85\text{ }^{\circ}\text{C}$

Impedance characteristics (Typical)

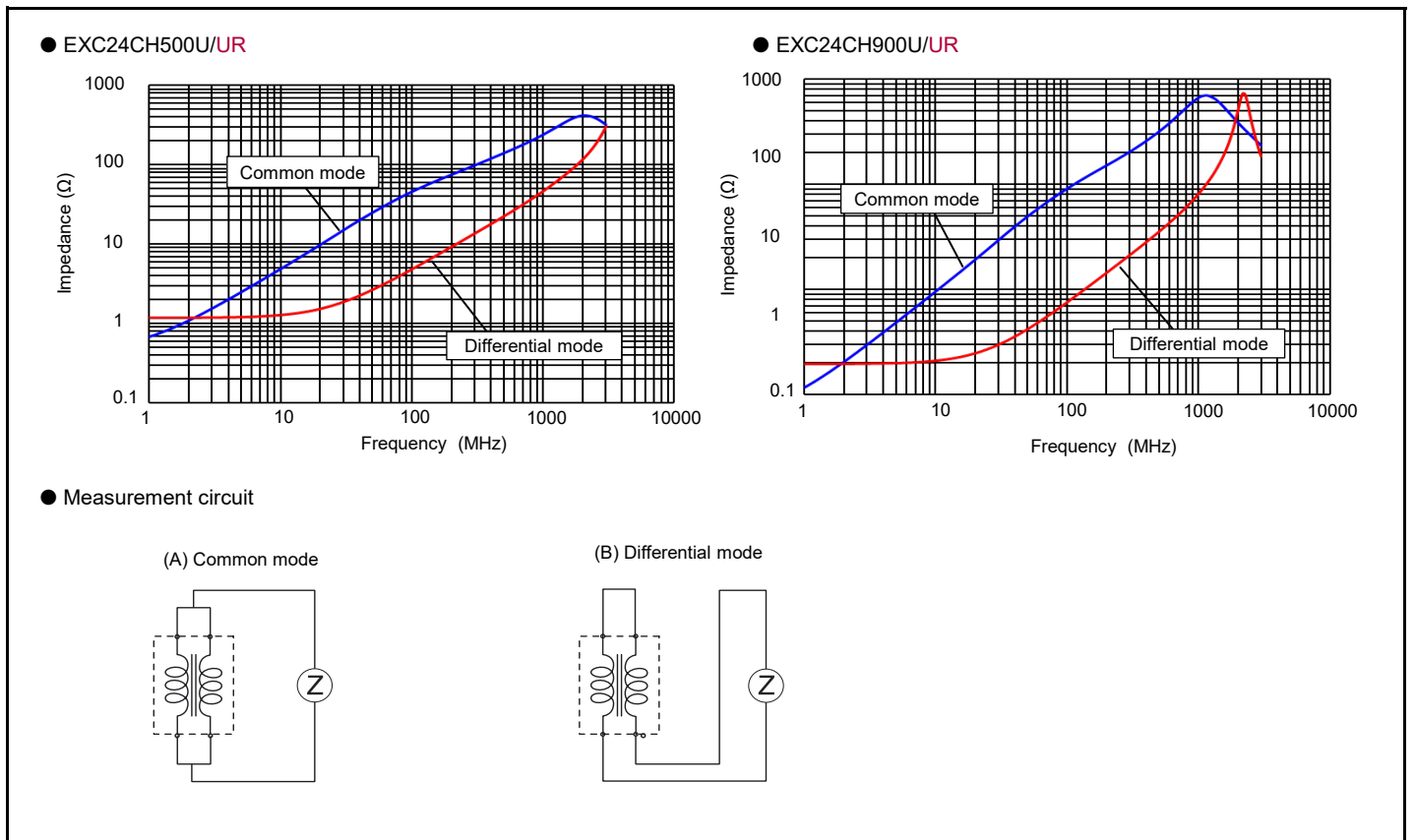

Common mode attenuation characteristics (Scc21), differential mode insertion loss characteristics (Sdd21) (reference data)

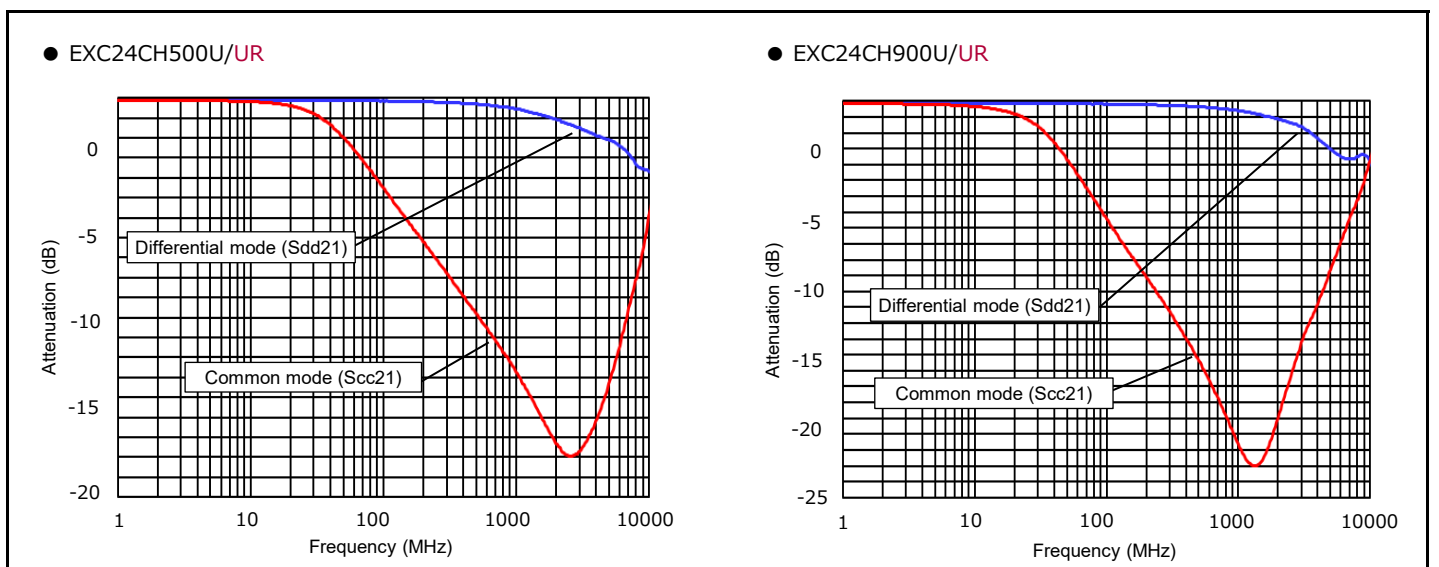

■ As for packaging methods, soldering conditions and safety precautions, please see data files

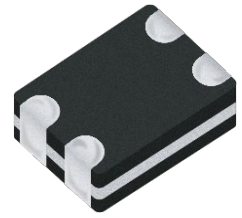

Common Mode Noise Filters

EXC24CG type

Features

- Elimination of radiation noises from high-speed differential transmissions
- Prevention of reflection of transmission signals and noise radiation by controlling TDR characteristic impedance as 100 Ω
- Satisfaction of eye pattern standards of HDMI waveforms with capability to improve waveform fluctuations of skew and overshoot
- Simple multilayer structure, excellent mass productivity and high reliability
- Small and thin (L 1.25 mm×W 1.00 mm×H 0.50 mm)
- RoHS compliant

Recommended applications

- AV equipment (LCD-TV, DVD/Blu-ray drives), Information equipment (PCs, HDD), Communications equipment (Mobile phones, Smartphones)
- Noise suppression of high-speed differential data lines such as HDMI, SATA and LAN

Explanation of part numbers

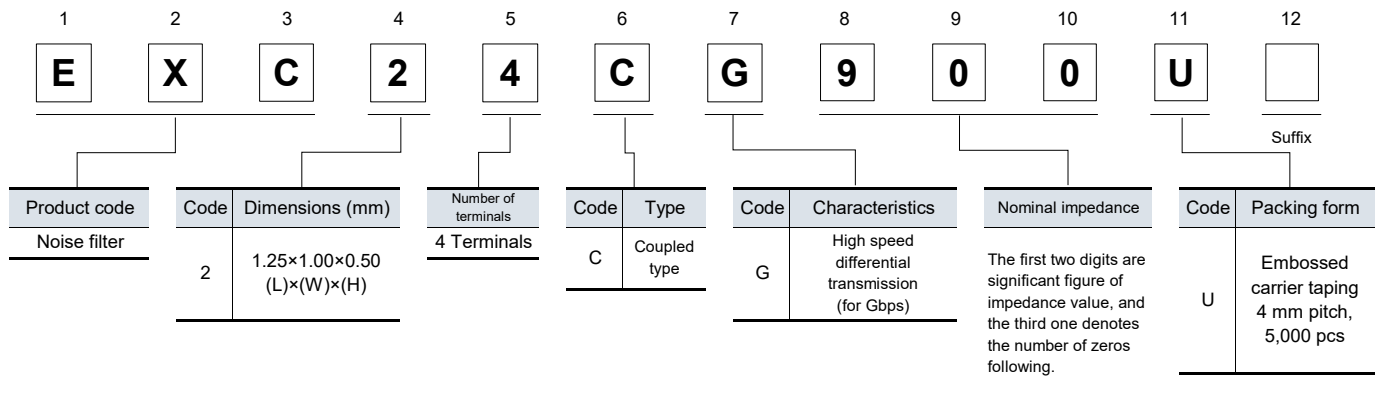

Construction

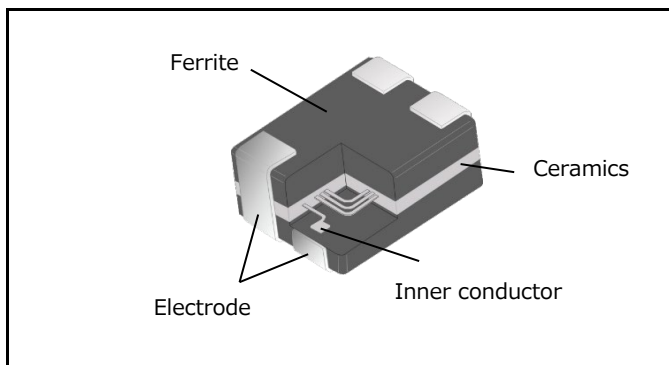

Circuit configuration (No polarity)

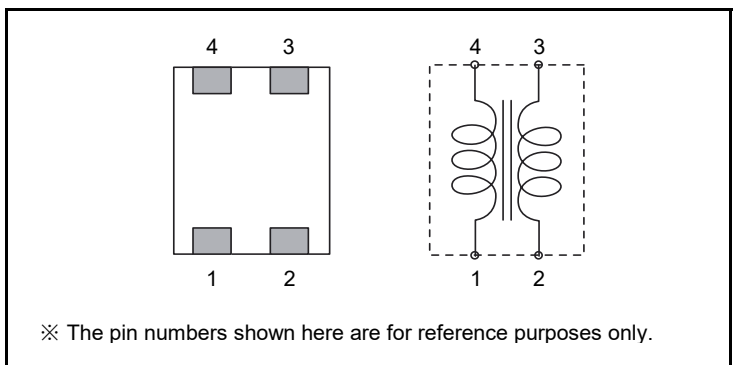

Dimensions in mm (not to scale)

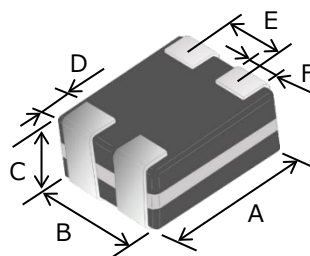

Part No. (inch size)	Dimensions						Mass (Weight) (mg/ pc.)
	A	B	C	D	E	F	
EXC24CG (0504)	1.25 ± 0.15	1.00 ± 0.15	0.50 ± 0.10	0.20 ± 0.15	0.55 ± 0.10	0.30 ± 0.10	3.0

Ratings

Part number	Impedance (Ω) at 100 MHz		Rated voltage (V) DC	Rated current (mA) DC	DC resistance (Ω) max.
	Common mode	Differential mode			
EXC24CG240U	24 \pm 25 %	15 max.	5	160	1.5
EXC24CG360U	36 \pm 25 %	15 max.	5	130	1.7
EXC24CG900U	90 \pm 25 %	20 max.	5	100	3.0

● Category temperature range $-40\text{ }^{\circ}\text{C}$ to $+85\text{ }^{\circ}\text{C}$

Impedance characteristics (Typical)

● EXC24CG240U

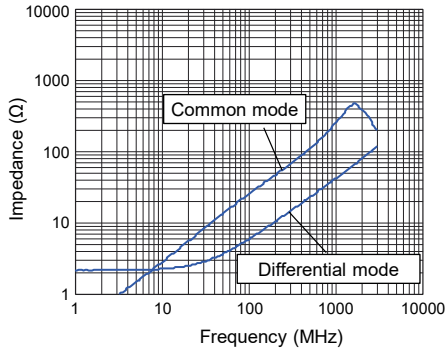

● EXC24CG360U

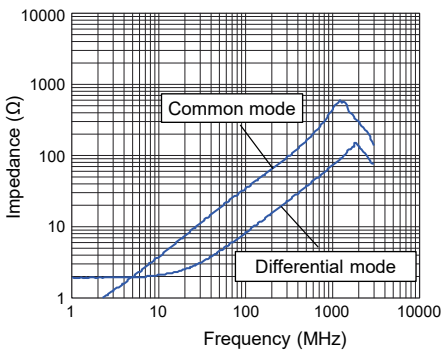

● EXC24CG900U

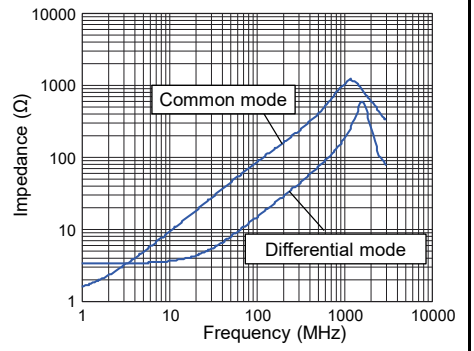

● Measurement circuit

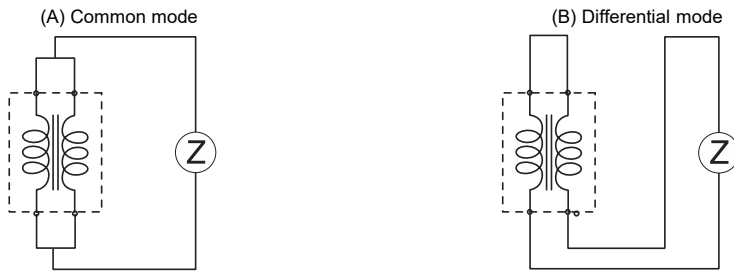

Common mode attenuation characteristics (Scc21), differential mode insertion loss characteristics (Sdd21) (reference data)

● EXC24CG240U

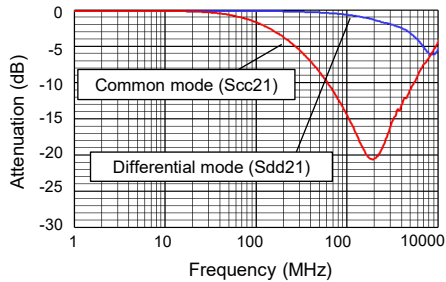

● EXC24CG360U

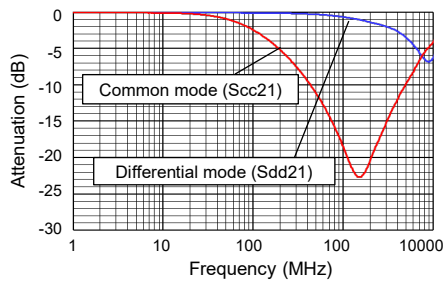

● EXC24CG900U

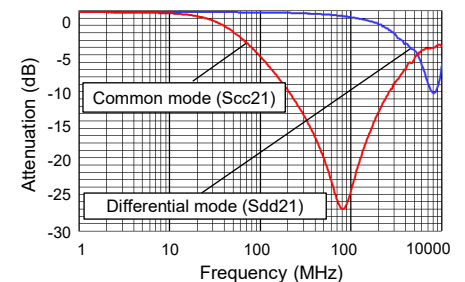

■ As for packaging methods, soldering conditions and safety precautions, please see data files



Common Mode Noise Filters

EXC24CE/CF type

Features

- Elimination of radiation noises from high-speed differential transmissions
- Strong multilayer structure, excellent reflow resistance and high mounting reliability
- Magnetic shield type with no leakage
- High-Q impedance : EXC24CF
- Small and thin (L 1.25 mm×W 1.00 mm×H 0.50 mm)
- RoHS compliant

Recommended applications

- AV equipment (LCD-TV, DVD/Blu-ray drives), Information equipment (PCs, HDD, Printers), Communications equipment (Mobile phones, Smartphones)
- Noise suppression of high-speed differential data lines such as USB 2.0 and LVDS

Explanation of part numbers

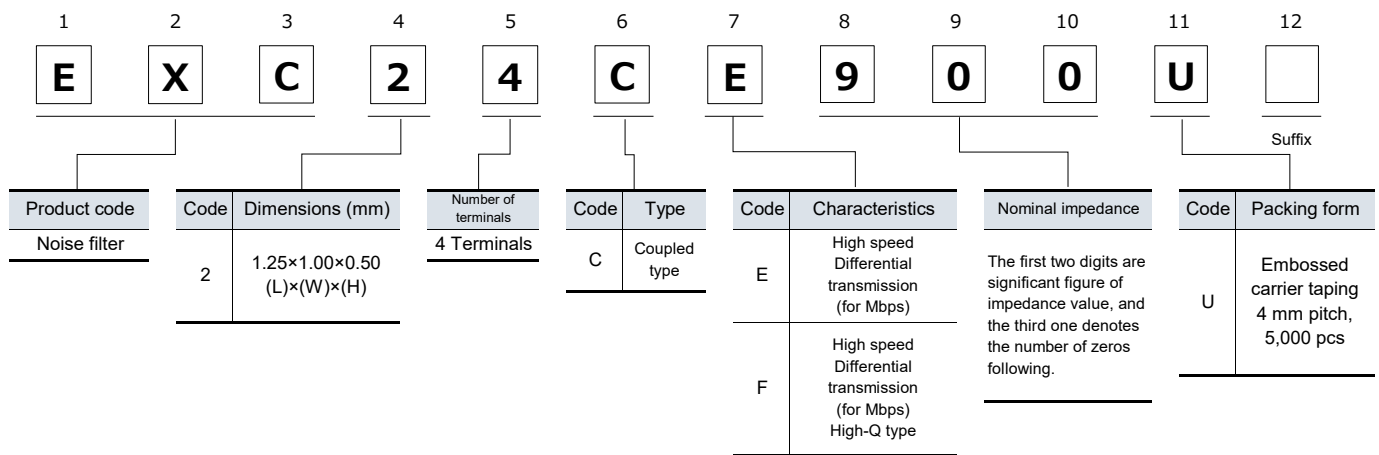

Construction

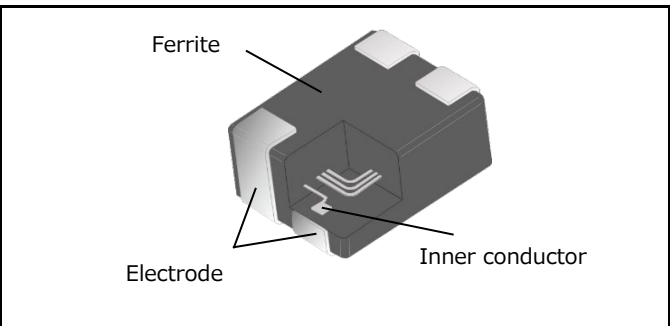

Circuit configuration (No polarity)

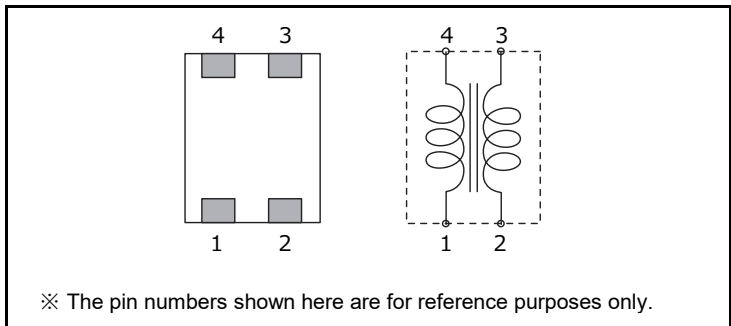

Dimensions in mm (not to scale)

Part No. (inch size)	Dimensions						Mass (Weight) (mg/ pc.)
	A	B	C	D	E	F	
EXC24CE (0504)	1.25 ± 0.15	1.00 ± 0.15	0.50 ± 0.10	0.20 ± 0.15	0.55 ± 0.10	0.30 ± 0.10	3.0
EXC24CF (0504)							

Ratings

Part number	Impedance (Ω) at 100 MHz		Rated voltage (V) DC	Rated current (mA) DC	DC resistance (Ω) max.
	Common mode	Differential mode			
EXC24CE360UP	36 $\Omega \pm 25\%$	20 Ω max.	5	200	1.0
EXC24CE900U	90 $\Omega \pm 25\%$	15 Ω max.	5	160	1.75
EXC24CE121U	120 $\Omega \pm 25\%$	18 Ω max.	5	140	2.2
EXC24CE201U	200 $\Omega \pm 25\%$	20 Ω max.	5	130	2.7
NEW EXC24CE331U	330 $\Omega \pm 25\%$	35 Ω max.	5	100	6.2
EXC24CF900U	90 $\Omega \pm 25\%$	20 Ω max.	5	130	2.5

● Category temperature range $-40\text{ }^{\circ}\text{C}$ to $+85\text{ }^{\circ}\text{C}$

Impedance characteristics (Typical)

● EXC24CE360UP

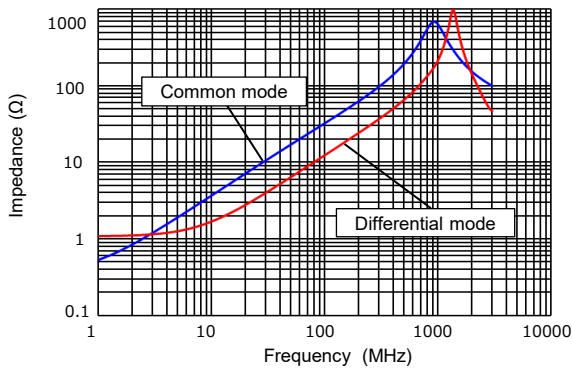

● EXC24CE900U

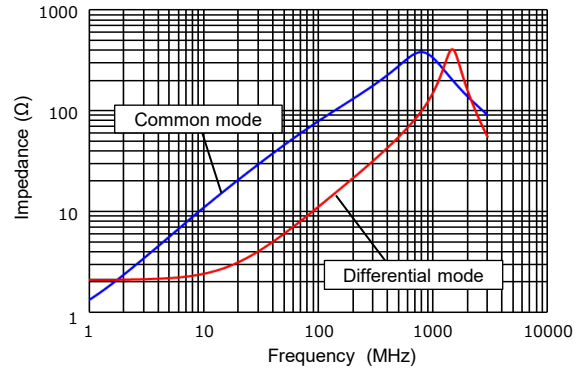

● EXC24CE121U

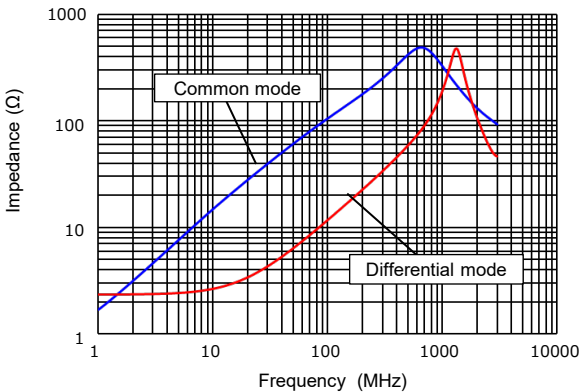

● EXC24CE201U

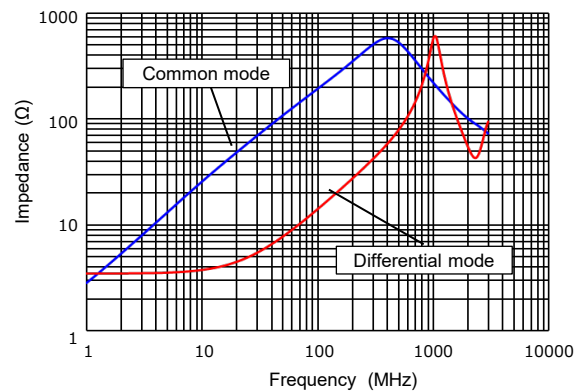

● EXC24CE331U

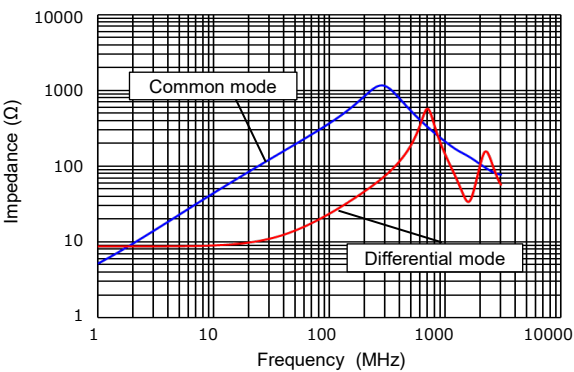

● EXC24CF900U

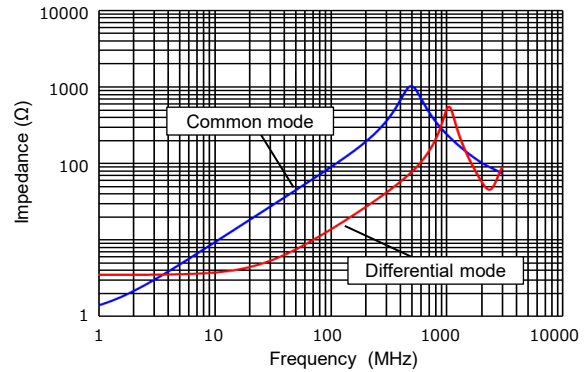

● Measurement circuit

(A) Common mode

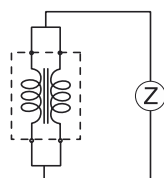

(B) Differential mode

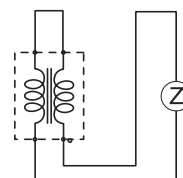

Common mode attenuation characteristics (Scc21), differential mode insertion loss characteristics (Sdd21) (reference data)

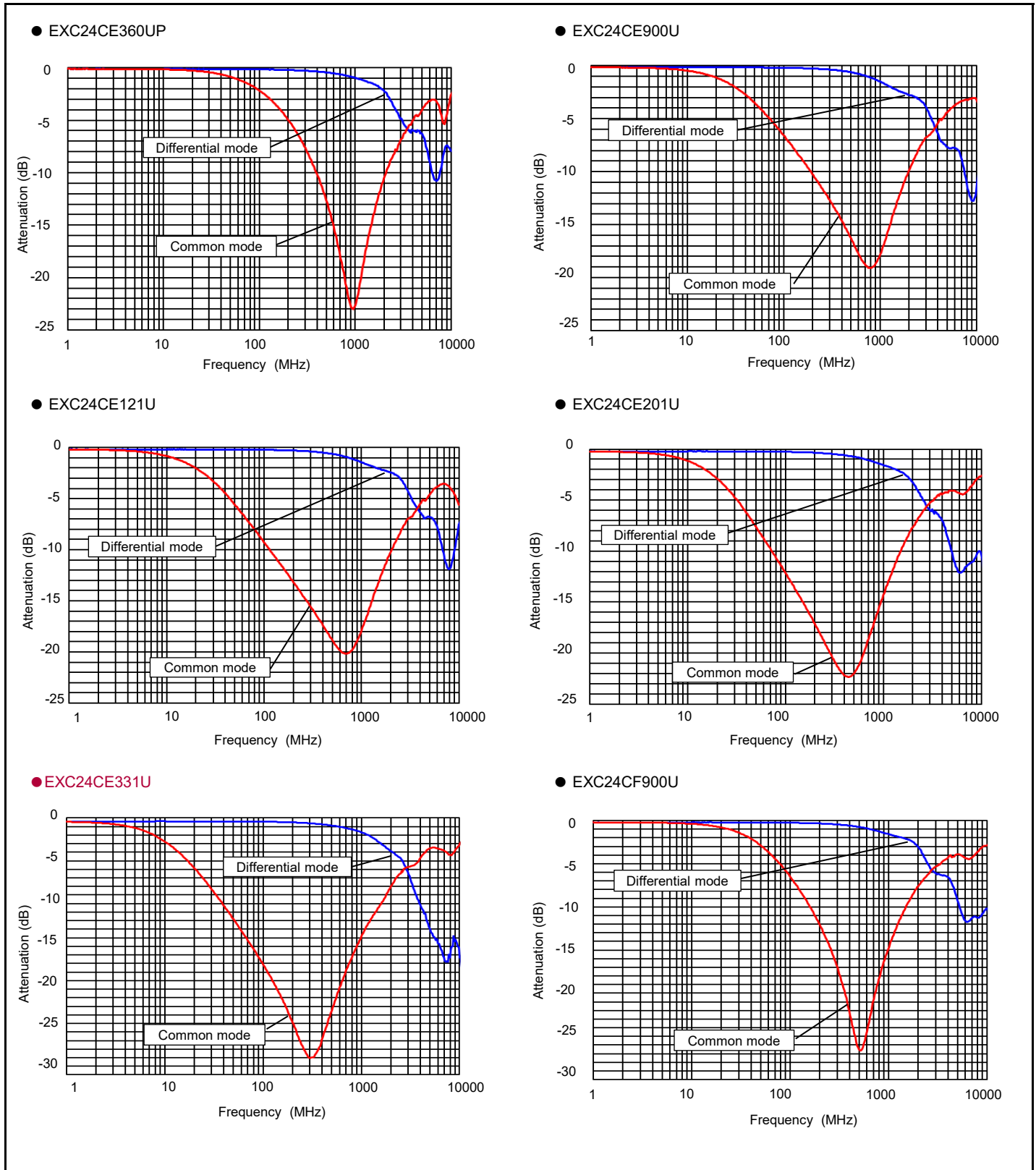

■ As for packaging methods, soldering conditions and safety precautions, please see data files

Common Mode Noise Filters

EXC34CG/CE type



Features

- Thin type, built-in filter circuit (L 2.0 mm×W 1.25 mm×H 0.50 mm)
- Noise suppression of high-speed differential transmission lines with little influence of waveform rounding on signal transmission
- Strong multilayer/sintered structure, excellent reflow resistance and high mounting reliability
- Lead, halogen and antimony-free
- RoHS compliant

Recommended applications

- AV equipment (LCD-TV, DVD/Blu-ray drives), Information equipment (PCs, HDD, Printers)
- Noise suppression of high-speed differential data lines such as USB2.0, LVDS, HDMI and LAN

Explanation of part numbers

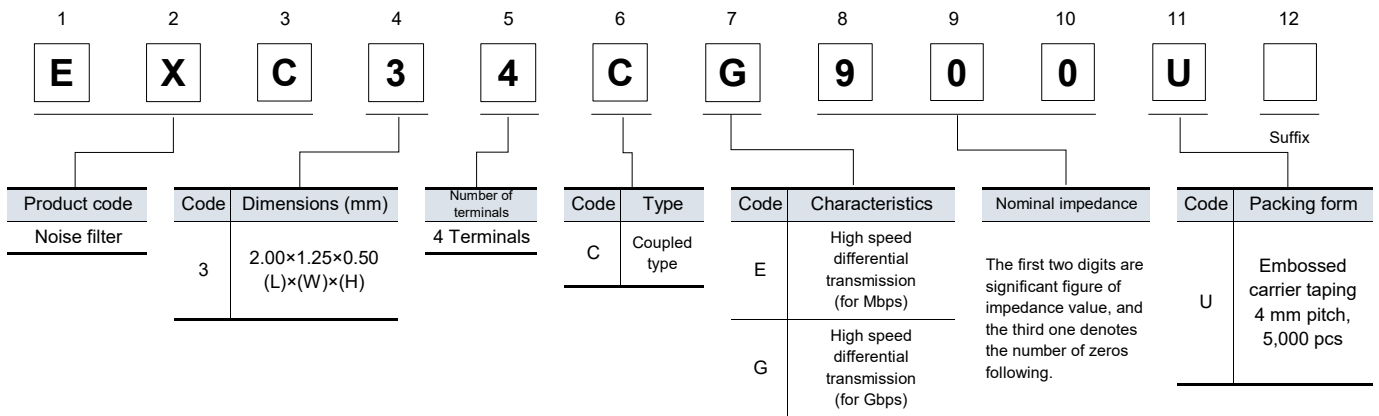

Construction

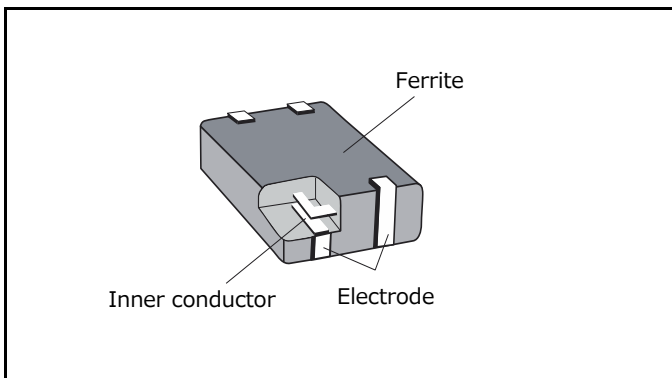

Circuit configuration (No polarity)

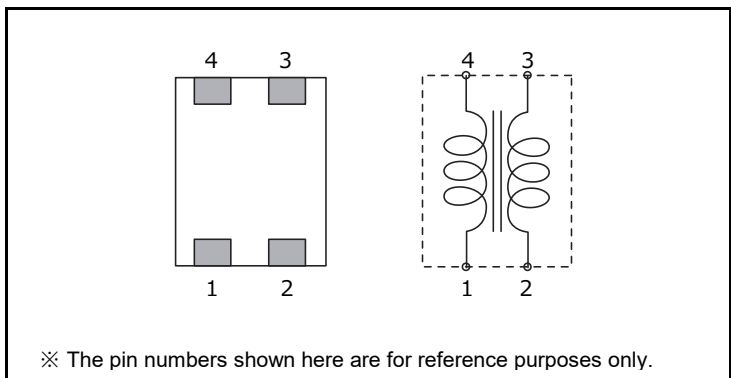

Dimensions in mm (not to scale)

Part No. (inch size)	Dimensions						Mass (Weight) (mg/ pc.)
	A	B	C	D	E	F	
EXC34CG (0805)	2.00 ± 0.15	1.25 ± 0.15	0.50 ± 0.10	0.30 ± 0.20	0.80 ± 0.10	0.30 ± 0.15	5.0
EXC34CE (0805)							

Unit : mm

Ratings

Part number	Impedance (Ω) at 100 MHz	Rated current (mA) DC	Rated voltage (V) DC	Insulation resistance (M Ω)min.	Withstand voltage (V) DC	DC resistance (Ω) max.
	Common mode					
EXC34CE670U	67 $\Omega \pm 25\%$	250	5	10 M Ω	125	0.8
EXC34CE900U	90 $\Omega \pm 25\%$	250	5	10 M Ω	125	0.8
EXC34CE121U	120 $\Omega \pm 25\%$	200	5	10 M Ω	125	1.0
EXC34CE201U	200 $\Omega \pm 25\%$	200	5	10 M Ω	125	1.0
EXC34CG900U	90 $\Omega \pm 25\%$	100	5	10 M Ω	125	3.0

● Category temperature range $-40\text{ }^{\circ}\text{C}$ to $+85\text{ }^{\circ}\text{C}$

Impedance characteristics (Typical)

● EXC34CE670U

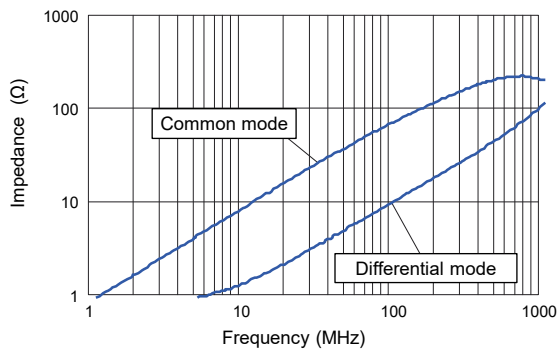

● EXC34CE900U

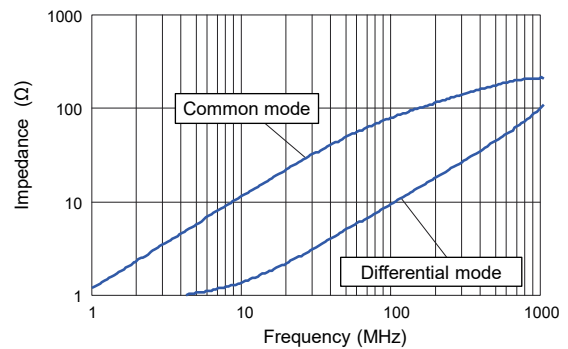

● EXC34CE121U

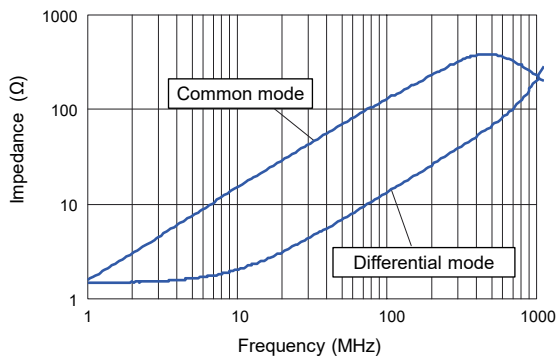

● EXC34CE201U

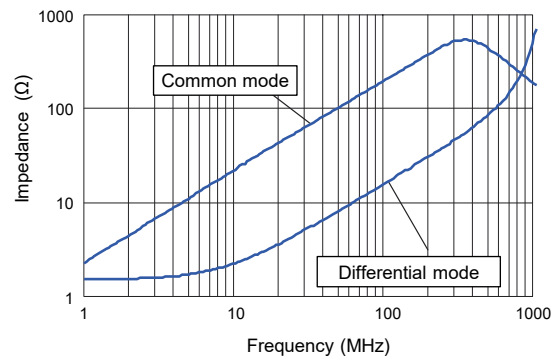

● EXC34CG900U

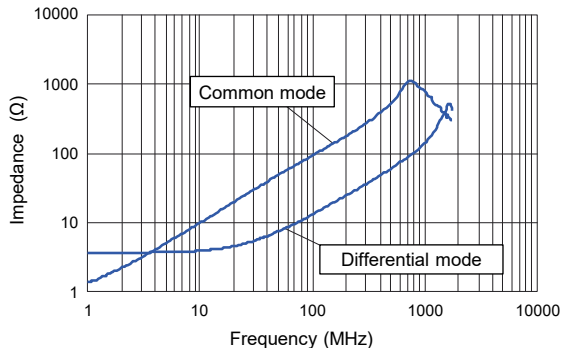

● Measurement circuit

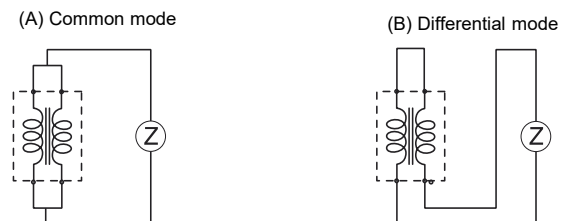

■ As for packaging methods, soldering conditions and safety precautions, please see data files

Common Mode Noise Filters Array

EXC18CG/CE type



Features

- Small and thin type, two built-in filter circuit (L 1.6 mm ×W 0.8 mm×H 0.4 mm)
- Noise suppression of high-speed differential transmission lines with little influence of waveform rounding on signal transmission
- Low DC resistance and low insertion loss
- High-Q value and high impedance of GHz zone : EXC18CG type
- Strong multilayer/sintered structure, excellent reflow resistance and high mounting reliability
- Lead, halogen and antimony-free
- RoHS compliant

Recommended applications

- AV equipment (LCD-TV, DVD/Blu-ray drives), Information equipment (PCs, HDD, Printers)
- Noise suppression of high-speed differential data lines such as USB2.0, LVDS, HDMI and LAN

Explanation of part numbers

1	2	3	4	5	6	7	8	9	10	11	12
E	X	C	1	8	C	E	9	0	0	U	
Product code	Code	Dimensions (mm)	Number of terminals	Code	Type	Code	Characteristics	Nominal impedance	Code	Packing form	Suffix
Noise filter	1	1.6×0.8×0.4 (L)×(W)×(H)	8 Terminals	C	Coupled type	E	High speed differential transmission	The first two digits are significant figure of impedance value, and the third one denotes the number of zeros following.	U	Embossed carrier taping 4 mm pitch, 5,000 pcs	
						G	High-Q type				

Construction

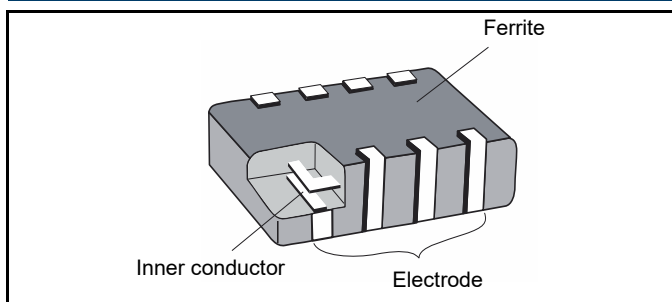

Circuit configuration (No polarity)

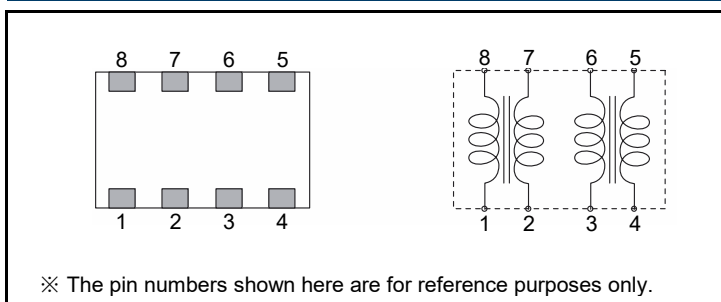

Dimensions in mm (not to scale)

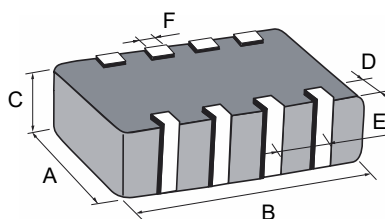

Part No. (inch size)	Dimensions						Mass (Weight) (mg/ pc.)
	A	B	C	D	E	F	
EXC18CG (0603)	0.8 ± 0.1	1.6 ± 0.1	0.4 ± 0.1	0.2 ± 0.1	0.4 ± 0.1	0.2 ± 0.1	2.6
EXC18CE (0603)							

Unit : mm

Ratings

Part number	Impedance (Ω) at 100 MHz		Rated voltage (V) DC	Rated current (mA) DC	DC resistance (Ω) max.
	Common mode	Differential mode			
EXC18CG430U	43 $\Omega \pm 25 \%$	15 Ω max.	5	100	2.7
EXC18CE650U	65 $\Omega \pm 20 \%$	18 Ω max.	5	140	1.8
EXC18CE900U	90 $\Omega \pm 20 \%$	20 Ω max.	5	130	2.0
EXC18CE201U	200 $\Omega \pm 20 \%$	22 Ω max.	5	100	3.5

● Category temperature range $-40\text{ }^{\circ}\text{C}$ to $+85\text{ }^{\circ}\text{C}$

Impedance characteristics (Typical)

● EXC18CG430U

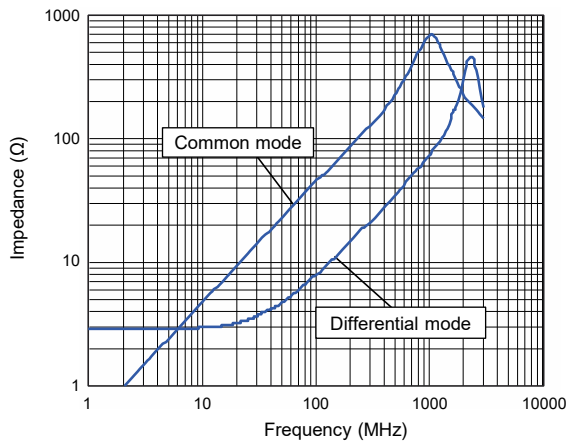

● EXC18CE650U

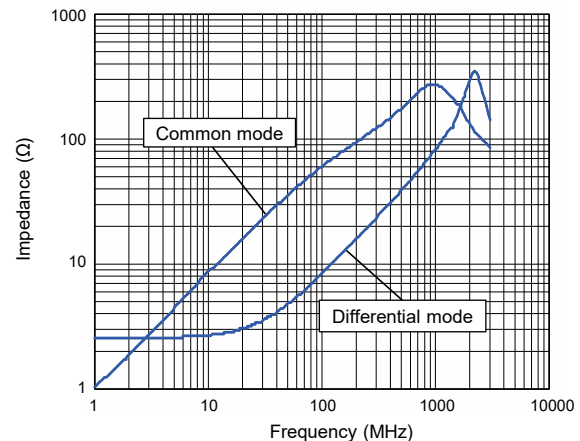

● EXC18CE900U

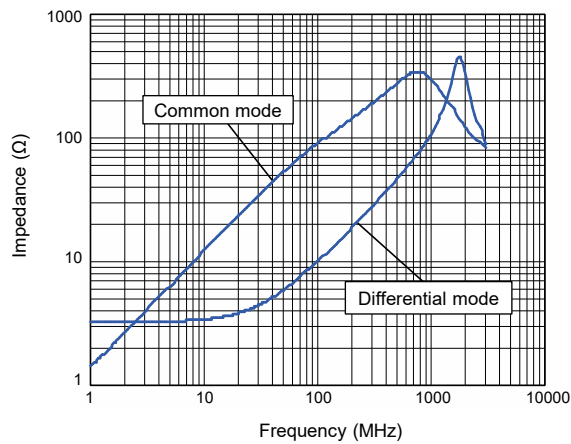

● EXC18CE201U

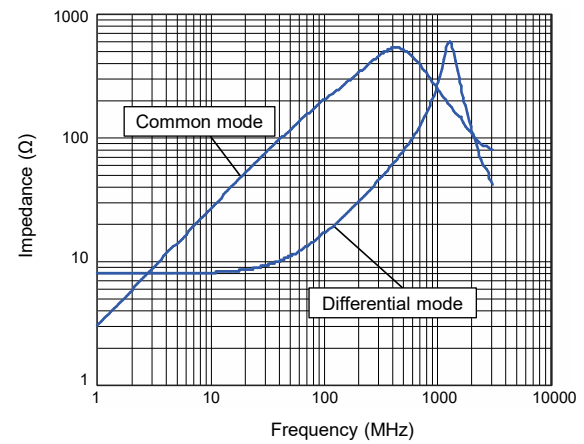

● Measurement circuit

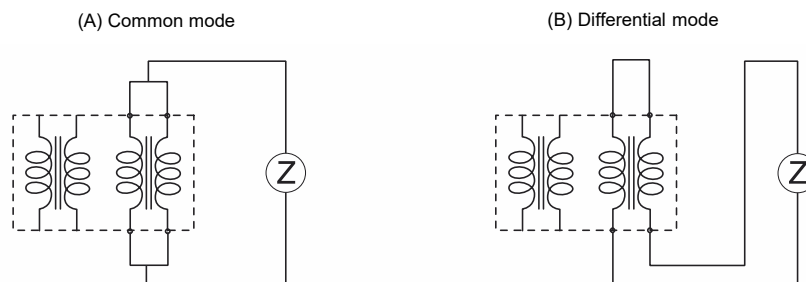

■ As for packaging methods, soldering conditions and safety precautions, please see data files

Common Mode Noise Filters Array

EXC28CH type



Features

- Small and thin type, two built-in filter circuit (L 2.0 mm×W 1.0 mm×H 0.5 mm)
- Suppression of high frequency noise with little influence of waveform rounding on signal transmission, achieved by setting high cut-off frequency between 6 and 10 GHz
- Strong multilayer/sintered structure, excellent reflow resistance and high mounting reliability
- Lead, halogen and antimony-free
- RoHS compliant

Recommended applications

- AV equipment (LCD-TV, DVD/Blu-ray drives), Information equipment (PCs, HDD, Printers)
- Noise suppression of high-speed differential data lines such as USB3.0, LVDS, HDMI and LAN

Explanation of part numbers

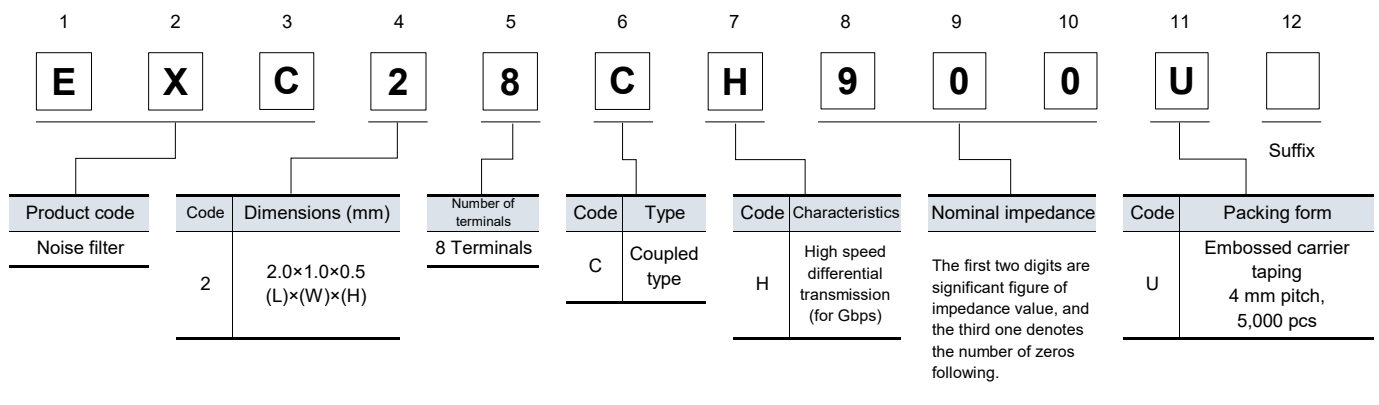

Construction

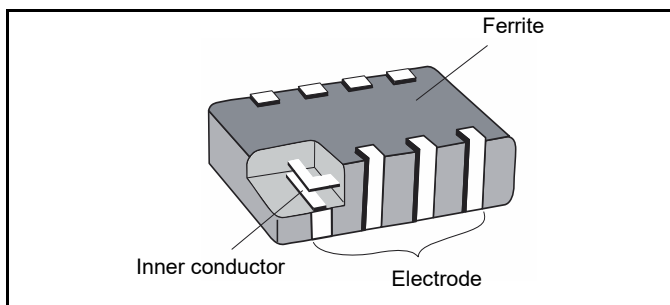

Circuit configuration (No polarity)

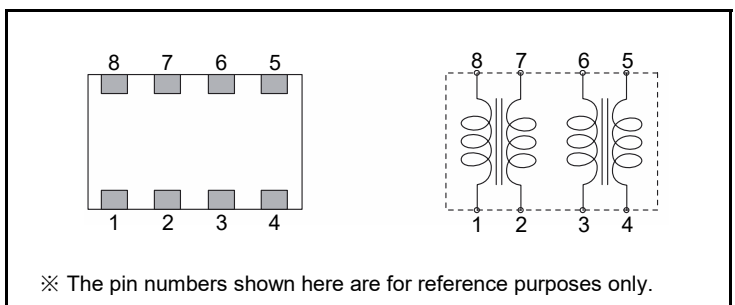

Dimensions in mm (not to scale)

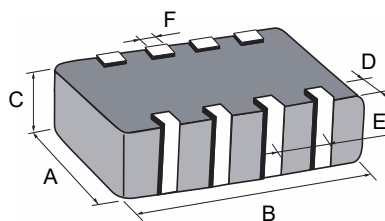

Part No. (inch size)	Dimensions						Mass (Weight) (mg/ pc.)
	A	B	C	D	E	F	
EXC28CH (0804)	1.00 ± 0.15	2.0 ± 0.2	0.5 ± 0.1	0.2 ± 0.15	0.5 ± 0.1	0.25 ± 0.1	5.0

Unit : mm

Ratings

Part number	Impedance (Ω) at 100 MHz		Cutoff frequency (GHz)	Rated voltage (V) DC	Rated current (mA) DC	DC resistance (Ω) max.
	Common mode	Differential mode				
EXC28CH500U	50 Ω \pm 25 %	13 Ω max.	10 Typ.	5	160	1.5
EXC28CH900U	90 Ω \pm 20 %	15 Ω max.	6 Typ.	5	130	2.5

● Category temperature range $-40\text{ }^{\circ}\text{C}$ to $+85\text{ }^{\circ}\text{C}$

Impedance characteristics (Typical)

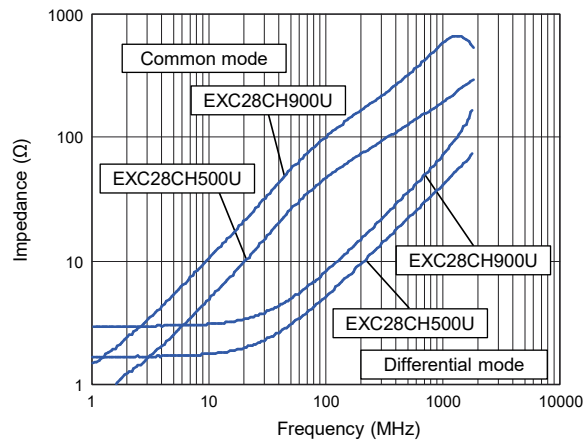

● Measurement circuit

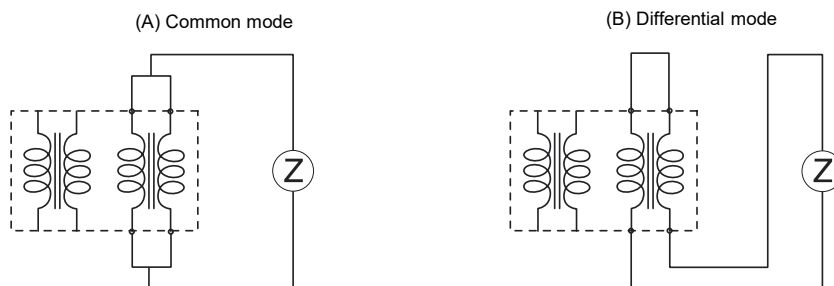

Insertion loss (Typical)

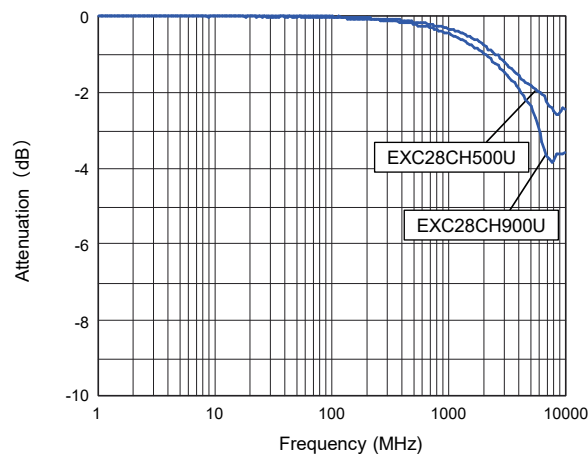

■ As for packaging methods, soldering conditions and safety precautions, please see data files

Common Mode Noise Filters Array

EXC28CG type



Features

- Small and thin type, two built-in filter circuit (L 2.0 mm×W 1.0 mm×H 0.5 mm)
- Prevention of weakening of transmission signals by controlling signal pass band as 3 GHz or above
- Prevention of reflection of transmission signals and noise radiation by controlling TDR characteristic impedance as 100 Ω
- Satisfaction of eye pattern standards of HDMI waveforms with capability to improve waveform fluctuations of Jitter and phase shift etc
- Elimination of radiation noises from high-speed differential transmissions
- Magnetic shield type with no leakage
- RoHS compliant

Recommended applications

- AV equipment (LCD-TV, DVD/Blu-ray drives), Information equipment (PCs, HDD), Communications equipment (Mobile phones, Smartphones)
- Noise suppression of high-speed differential data lines such as HDMI, SATA and LAN

Explanation of part numbers

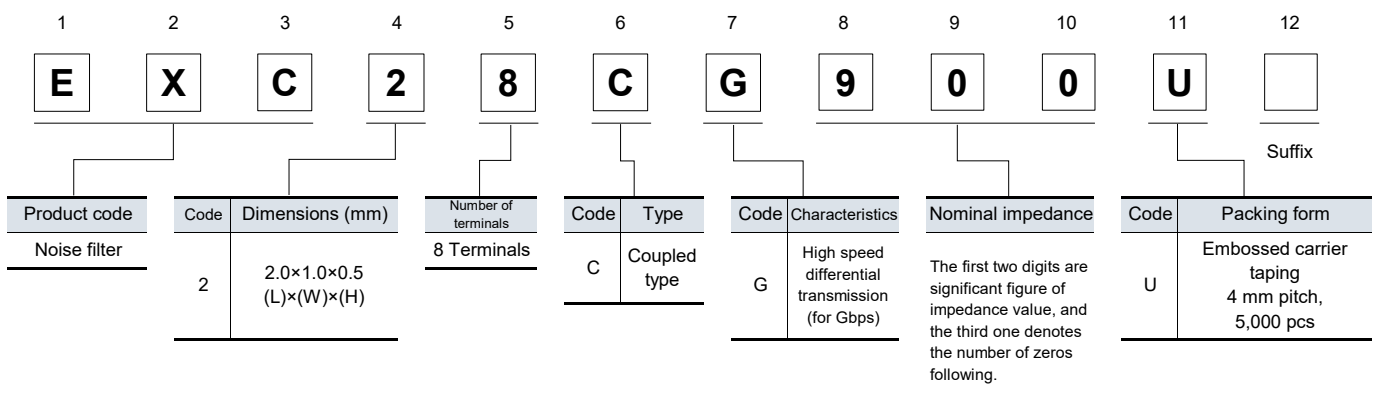

Construction

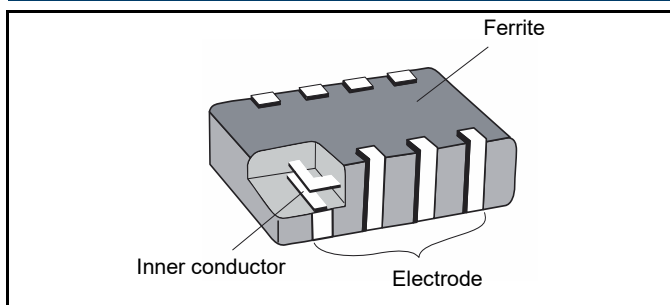

Circuit configuration (No polarity)

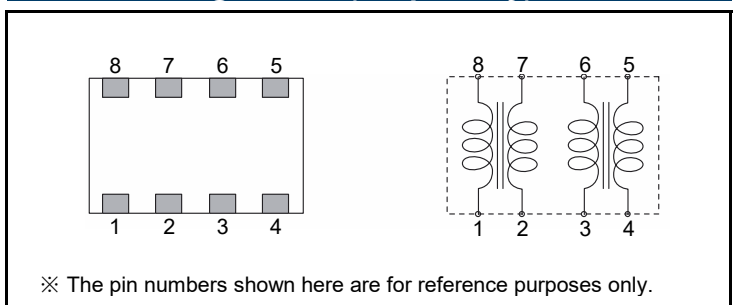

Dimensions in mm (not to scale)

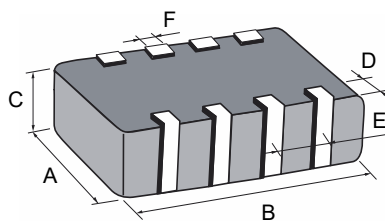

Unit : mm

Part No. (inch size)	Dimensions						Mass (Weight) (mg/ pc.)
	A	B	C	D	E	F	
EXC28CG (0804)	1.00 ± 0.15	2.0 ± 0.2	0.5 ± 0.1	0.2 ± 0.15	0.5 ± 0.1	0.25 ± 0.1	5.0

Ratings

Part number	Impedance (Ω) at 100 MHz		Rated voltage (V) DC	Rated current (mA) DC	DC resistance (Ω) max.
	Common mode	Differential mode			
EXC28CG240U	24 $\Omega \pm 25\%$	15 Ω max.	5	160	1.5
EXC28CG900U	90 $\Omega \pm 25\%$	17 Ω max.	5	130	3.0

● Category temperature range $-40\text{ }^{\circ}\text{C}$ to $+85\text{ }^{\circ}\text{C}$

Impedance characteristics (Typical)

● EXC28CG240U

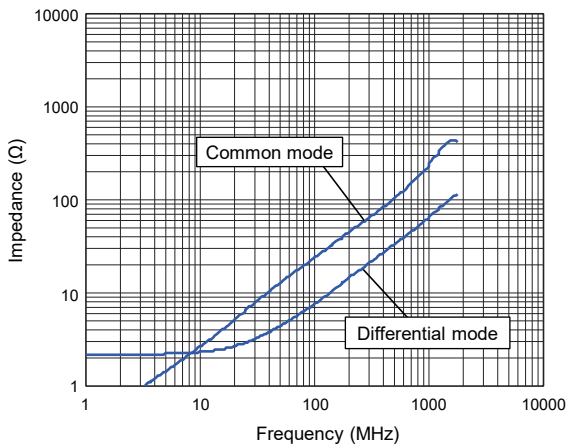

● EXC28CG900U

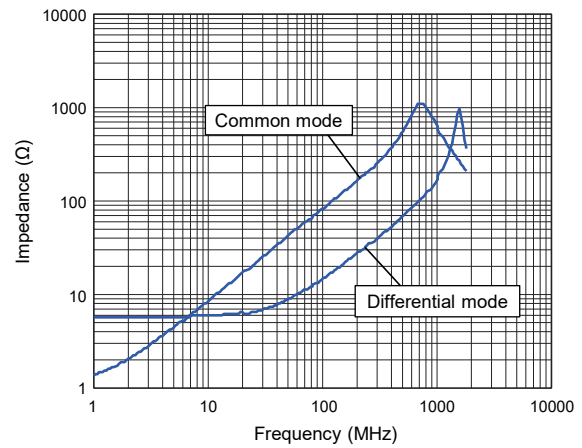

● Measurement circuit

(A) Common mode

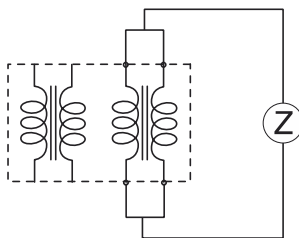

(B) Differential mode

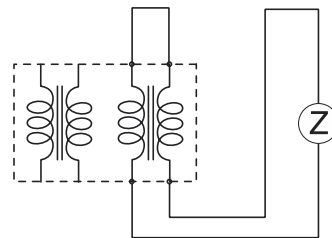

■ As for packaging methods, soldering conditions and safety precautions, please see data files

Common Mode Noise Filters Array

EXC28CE type



Features

- Small and thin type, two built-in filter circuit (L 2.0 mm×W 1.0 mm×H 0.5 mm)
- Elimination of radiation noises from high-speed differential transmissions
- Magnetic shield type with no leakage
- Strong multilayer/sintered structure, excellent reflow resistance and high mounting reliability
- Lead, halogen and antimony-free
- RoHS compliant

Recommended applications

- AV equipment (LCD-TV, DVD/Blu-ray drives), Information equipment (PCs, HDD, Printers), Communications equipment (Mobile phones, Smartphones)
- Noise suppression of high-speed differential data lines such as USB2.0 and LVDS

Explanation of part numbers

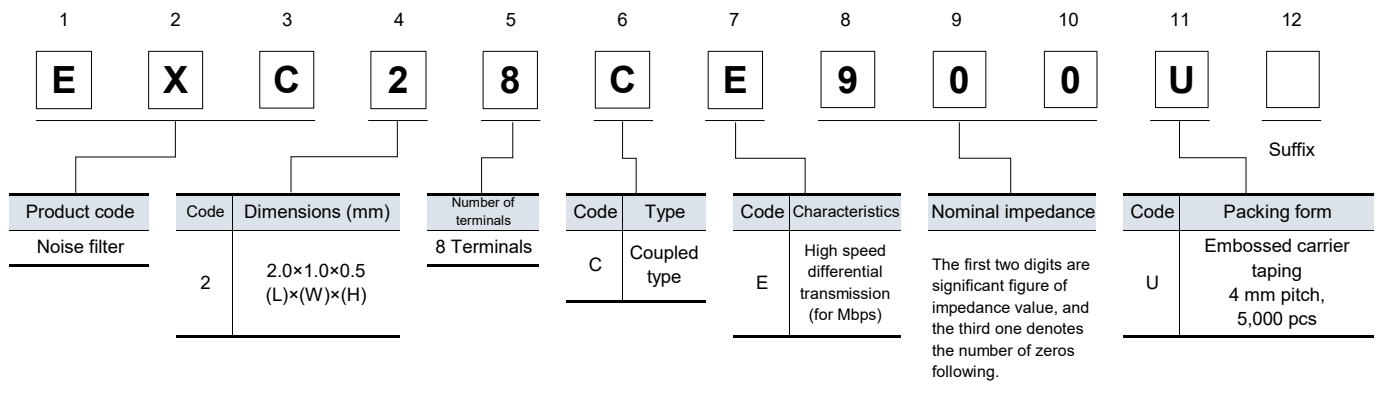

Construction

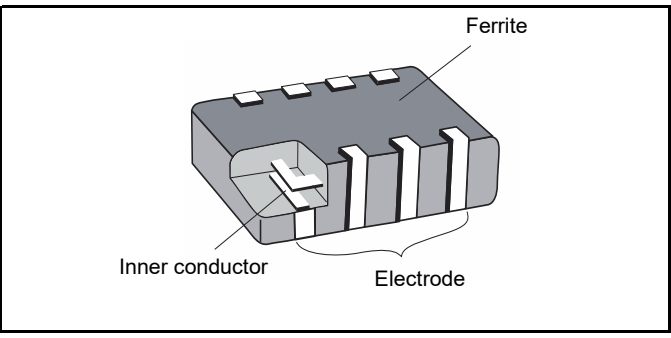

Circuit configuration (No polarity)

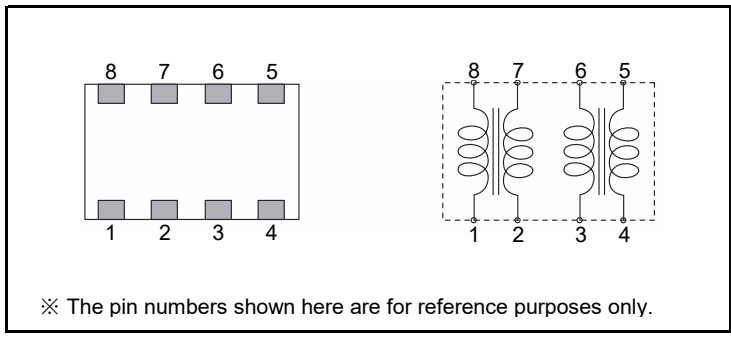

Dimensions in mm (not to scale)

Part No. (inch size)	Dimensions						Mass (Weight) (mg/ pc.)
	A	B	C	D	E	F	
EXC28CE (0804)	1.00 ± 0.15	2.0 ± 0.2	0.5 ± 0.1	0.2 ± 0.15	0.5 ± 0.1	0.25 ± 0.1	5.0

Unit : mm

Ratings

Part number	Impedance (Ω) at 100 MHz		Rated voltage (V) DC	Rated current (mA) DC	DC resistance (Ω) max.
	Common mode	Differential mode			
EXC28CE900U	90 $\Omega \pm 25\%$	15 Ω max.	5	160	1.5
EXC28CE121U	120 $\Omega \pm 25\%$	18 Ω max.	5	140	2.0
EXC28CE201U	200 $\Omega \pm 25\%$	20 Ω max.	5	130	2.5

● Category temperature range $-40\text{ }^{\circ}\text{C}$ to $+85\text{ }^{\circ}\text{C}$

Impedance characteristics (Typical)

● EXC28CE900U

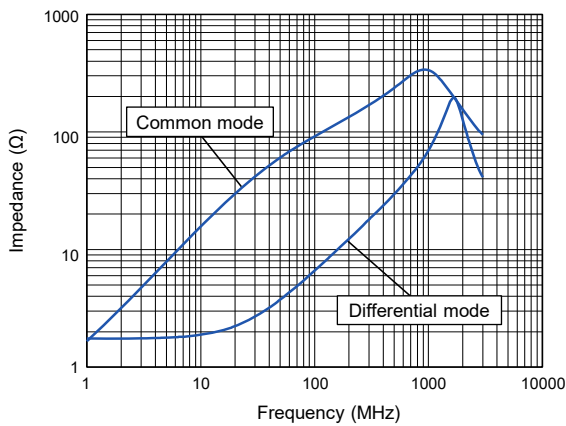

● EXC28CE121U

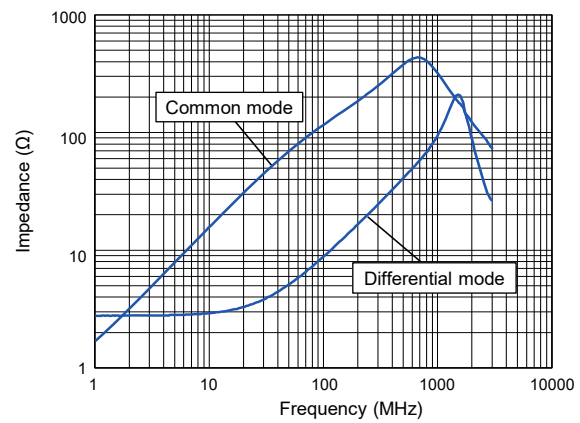

● EXC28CE201U

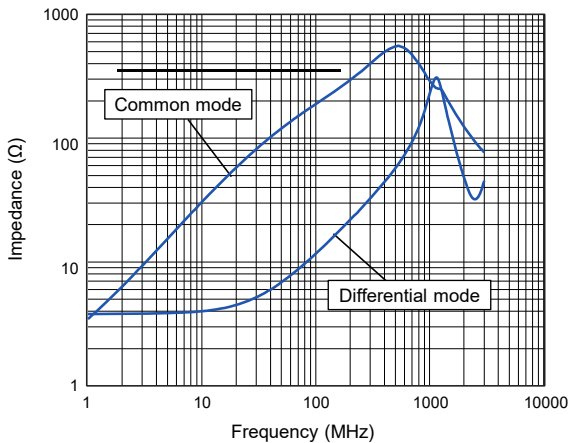

● Measurement circuit

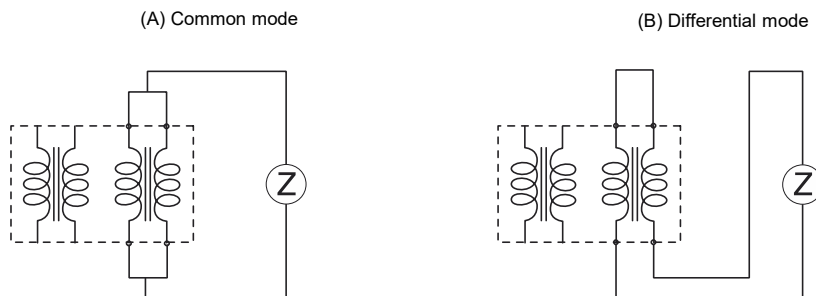

■ As for packaging methods, soldering conditions and safety precautions, please see data files

Packaging methods (Taping)

● Standard quantity

Part number	Size (inch)	Type	Kind of taping	Pitch (P ₁) (mm)	Quantity (pcs / reel)
EXCX4C	0202	Single	Pressed carrier taping	2	10,000
EXC14C	0302				
EXC16C	0403		Embossed carrier taping	4	5,000
EXC24C	0504				
EXC34C	0805				
EXC18C	0603	Array			
EXC28C	0804				

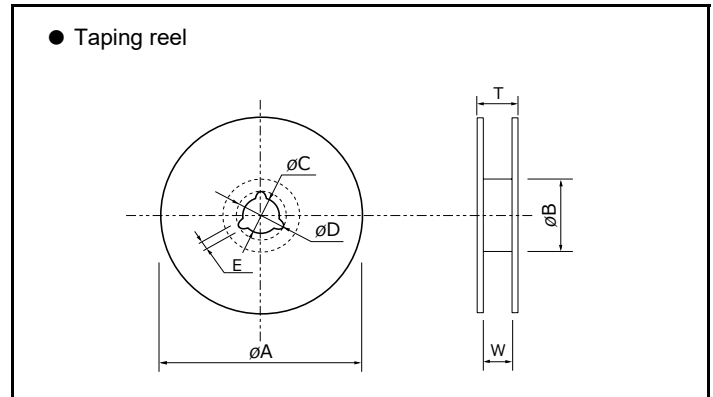
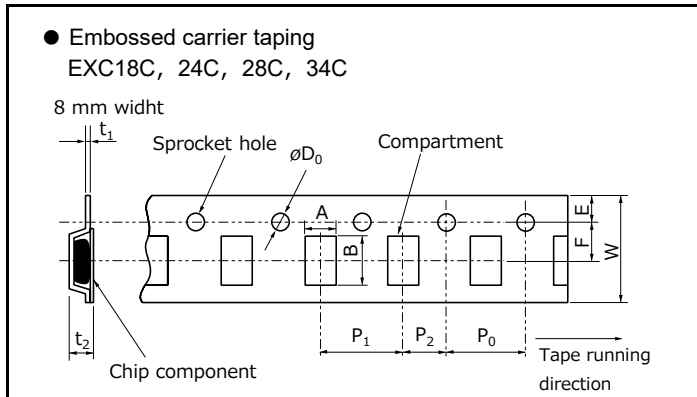
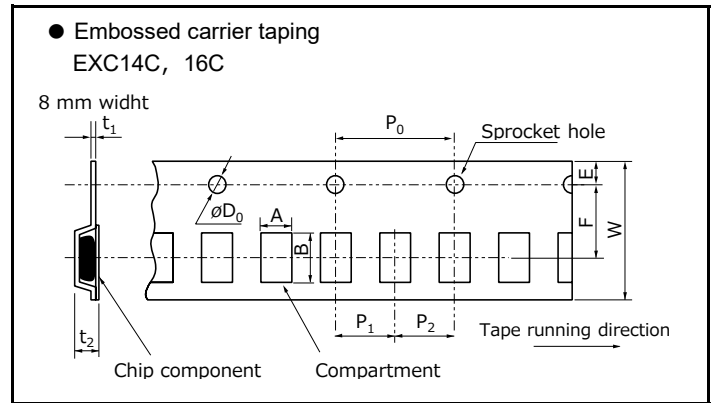
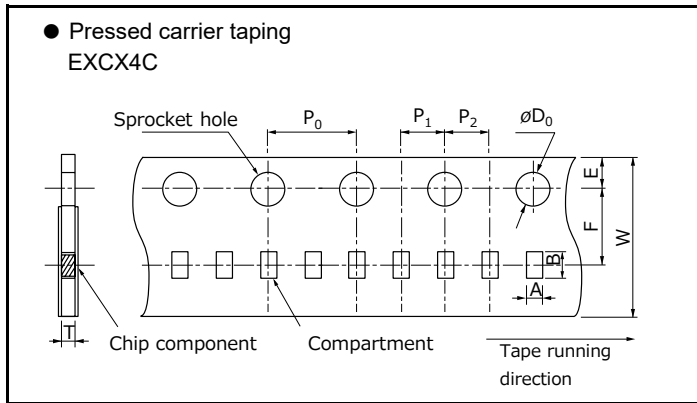

Pressed carrier taping

Unit : mm

Part number	A	B	W	F	E	P ₁	P ₂	P ₀	øD ₀	T
EXCX4C	0.60±0.10	0.80±0.10	8.0±0.2	3.50±0.05	1.75±0.10	2.0±0.1	2.0±0.1	4.0±0.1	1.5 ^{+0.1} ₀	0.35 typ.

Embossed carrier taping

Unit : mm

Part number	A	B	W	F	E	P ₁	P ₂	P ₀	øD ₀	t ₁	t ₂
EXC14C	0.75±0.10	0.95±0.10	8.0±0.2	3.50±0.05	1.75±0.10	2.0±0.1	2.0±0.1	4.0±0.1	1.5 ^{+0.1} ₀	0.25±0.05	0.85±0.15
EXC16C	0.77±0.10	0.99±0.10									0.80±0.15
EXC18C	1.00±0.10	1.80±0.10	8.0±0.2	3.5±0.1	1.75±0.10	4.0±0.1	2.0±0.1	4.0±0.1	1.5 ^{+0.1} ₀	0.25±0.05	0.80±0.05
EXC24C	1.20±0.15	1.45±0.15									0.90±0.15
EXC28C	2.25±0.15										
EXC34C	1.50±0.20	2.30±0.20									

Standard reel dimensions

Unit : mm

Part number	øA	øB	øC	øD	E	W	T
EXCX4C	180.0±3.0	60.0±1.0	13.0±0.2	21.0±0.8	2.0±0.5	9.0±0.3	11.4±1.0
EXC14C			13.0±0.5				11.4±1.5
EXC16C							
EXC18C							
EXC24C							
EXC28C							
EXC34C							

Design and specifications are each subject to change without notice. Ask factory for the current technical specifications before purchase and/or use. Should a safety concern arise regarding this product, please be sure to contact us immediately.

Recommended land pattern design

● Single

EXCX4C, 14C, 24C, 34C

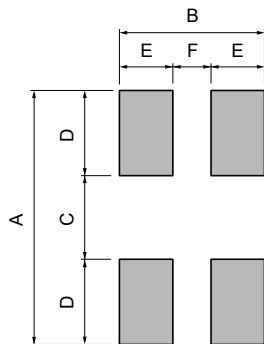

EXC16C

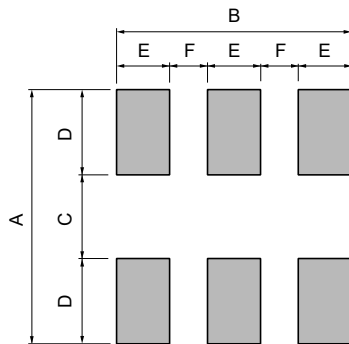

● Array

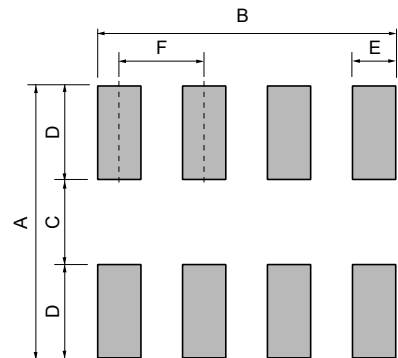

Part number	Dimensions					
	A	B	C	D	E	F
EXCX4C	0.80 to 0.90	0.60 to 0.75	0.20 to 0.30	0.30	0.20 to 0.25	0.20 to 0.25
EXC14C	0.80 to 1.00	0.80	0.30	0.25 to 0.35	0.30	0.20
EXC24C	1.60 to 2.00	0.95	0.70	0.45 to 0.65	0.35	0.25
EXC34C	2.60	1.20	1.10	0.75	0.40	0.40
EXC16C	0.99	0.85	0.33	0.33	0.15	0.20

Part number	Dimensions					
	A	B	C	D	E	F
EXC18C	1.4	1.4	0.4	0.5	0.2	0.4
EXC28C	1.4	1.75	0.4	0.5	0.25	0.5

Unit : mm

Recommended soldering conditions

Recommendations and precautions are described below

● Recommended soldering conditions for reflow

- Reflow soldering shall be performed a maximum of two times.
- Please contact us for additional information when used in conditions other than those specified.
- Please measure the temperature of the terminals and study every kind of solder and printed circuit board for solderability before actual use.

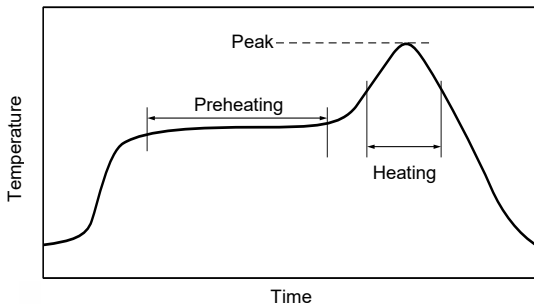

For soldering (Example : Sn-37Pb)

	Temperature	Time
Preheating	140 °C to 160 °C	60 s to 120 s
Main heating	Above 200 °C	30 s to 40 s
Peak	235 ± 10 °C	max. 10 s

For lead-free soldering (Example :Sn-3Ag-0.5Cu)

	Temperature	Time
Preheating	150 °C to 170 °C	60 s to 120 s
Main heating	Above 230 °C	30 s to 40 s
Peak	max. 260 °C	max. 10 s

● Flow soldering

- We do not recommend flow soldering, because flow soldering may cause bridges between the electrodes.

《Repair with hand soldering》

- Preheat with a blast of hot air or similar method. Use a soldering iron with a tip temperature of 350 °C or less. Solder each electrode for 3 seconds or less.
- Never touch this product with the tip of a soldering iron.

 This series is not recommended for new design.
Click [here](#) for replacement.



Common Mode Noise Filters With ESD Suppressor EXC14CS type

Features

- Provides EMI Filtering and ESD Protection (L 0.85 mm×W 0.65 mm×H 0.45mm)
- ESD and noise suppression of high-speed differential transmission lines with little influence of waveform rounding on signal transmission
- High Common mode attenuation in the range between 700 MHz and 1000 MHz (RF band)
- Strong multilayer/sintered structure, excellent reflow resistance and high mounting reliability
- RoHS compliant

Recommended applications

- Smartphones, Tablet PCs and DSC
- ESD and noise suppression of high-speed differential data lines such as MIPI and USB

Explanation of part numbers

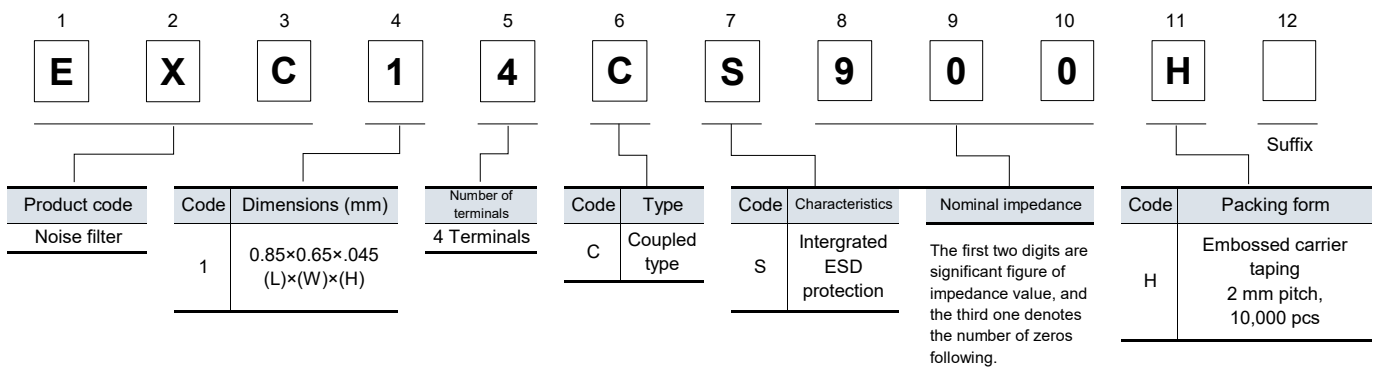

Construction

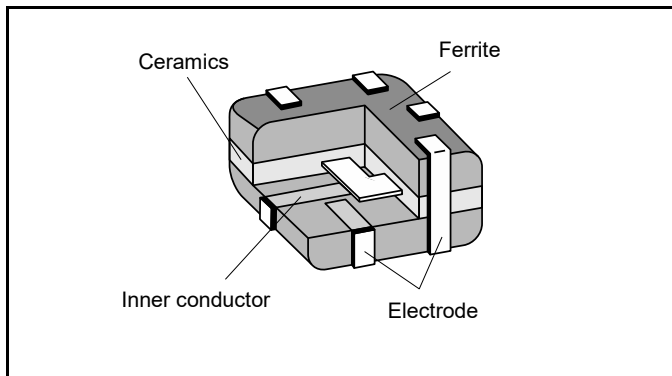

Circuit configuration (No polarity)

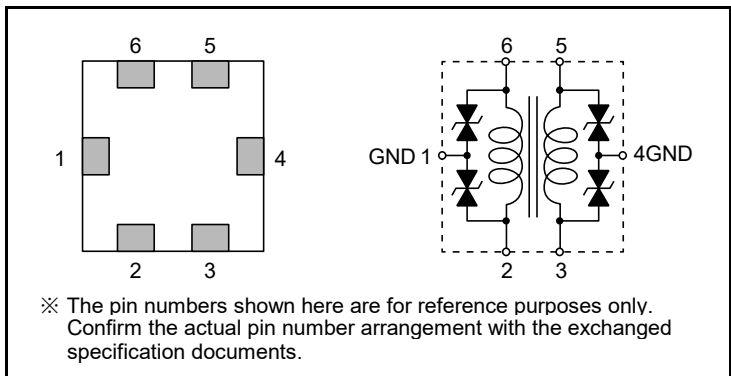

Dimensions in mm (not to scale)

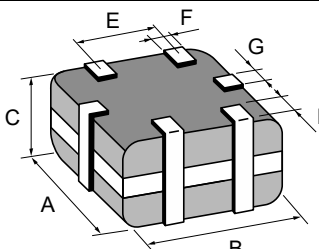

Part No. (inch size)	Dimensions							Mass (Weight) (mg/ pc.)
	A	B	C	D	E	F	G	
EXC14CS (0302)	0.67 ± 0.05	0.87 ± 0.05	0.45 ± 0.05	0.15 ± 0.07	0.40 ± 0.05	0.20 ± 0.07	0.20 ± 0.07	0.97

Unit : mm

Ratings

Part number	Impedance (Ω) at 100 MHz		Rated voltage (V) DC	Rated current (mA) DC	DC resistance (Ω) max.
	Common mode	Differential mode			
EXC14CS350H	35 Ω \pm 30 %	15 Ω max.	5	100	2.0 \pm 30 %
EXC14CS900H	90 Ω \pm 20 %	20 Ω max.	5	100	3.3 \pm 30 %

● Category temperature range -40°C to $+85^{\circ}\text{C}$

Impedance characteristics (Typical)

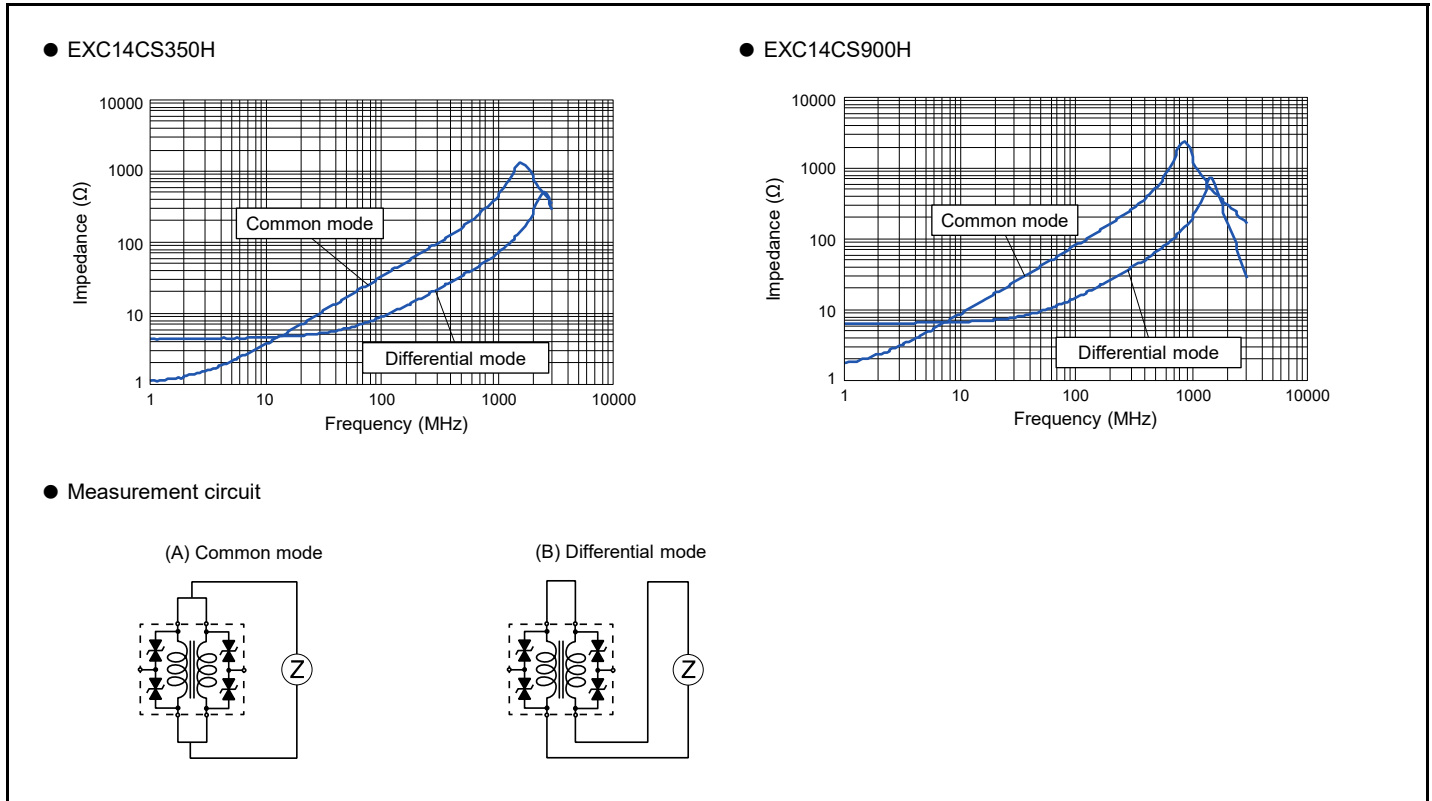

ESD suppression characteristics (Typ. : IEC6100-4-2, 8 kV contact discharge)

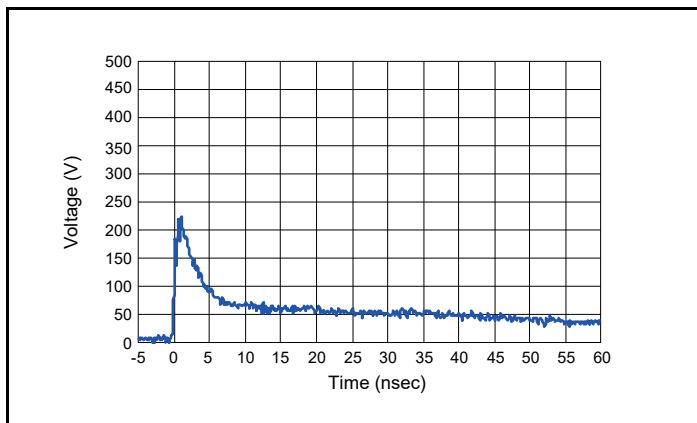

Recommended land pattern design (not to scale)

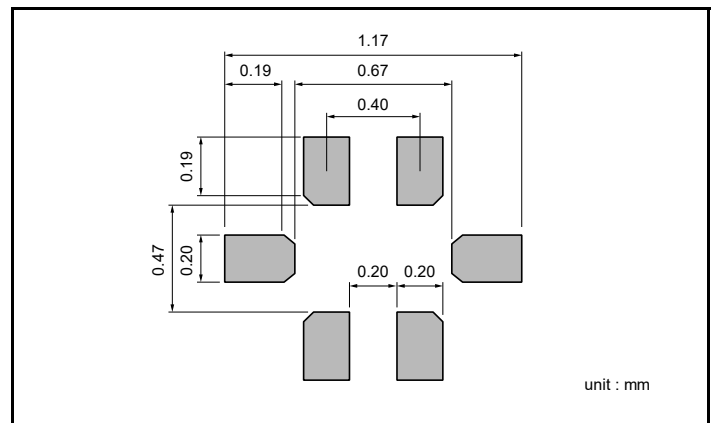

■ As for packaging methods, soldering conditions and safety precautions, please see data files

 This series is not recommended for new design. Click [here](#) for replacement.



Common Mode Noise Filters With ESD Suppressor EXC24CS type

Features

- Provides EMI Filtering and ESD Protection (L 1.25 mm×W 1.00 mm×H 0.50 mm)
- ESD and noise suppression of high-speed differential transmission lines with little influence of waveform rounding on signal transmission
- High Common mode attenuation in the range between 700 MHz and 1000 MHz (RF band)
- Strong multilayer/sintered structure, excellent reflow resistance and high mounting reliability
- Lead, halogen and antimony-free
- RoHS compliant

Recommended applications

- Smartphones, Tablet PCs and DSC
- ESD and noise suppression of high-speed differential data lines such as MIPI and USB

Explanation of part numbers

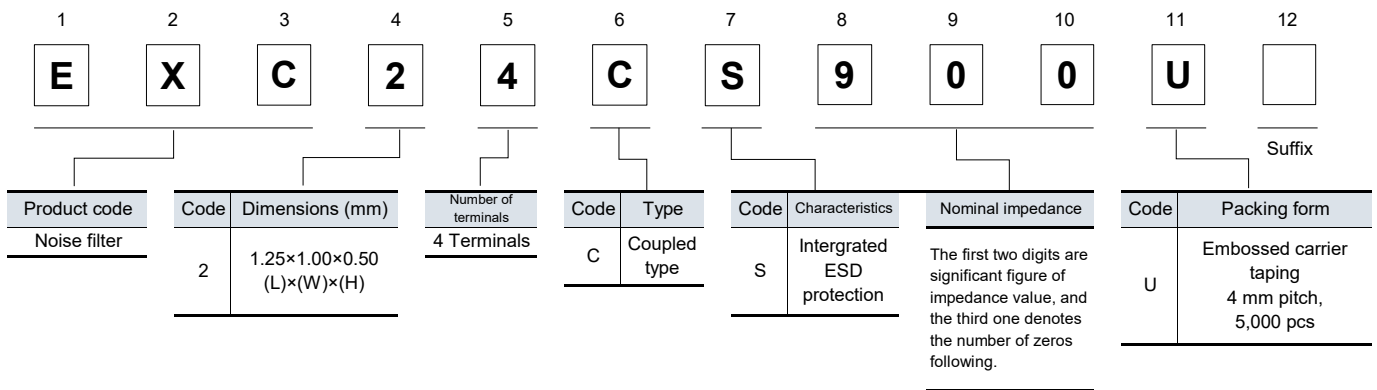

Construction

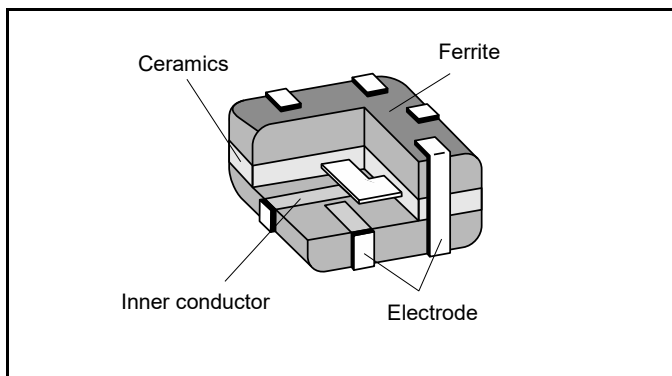

Circuit configuration (No polarity)

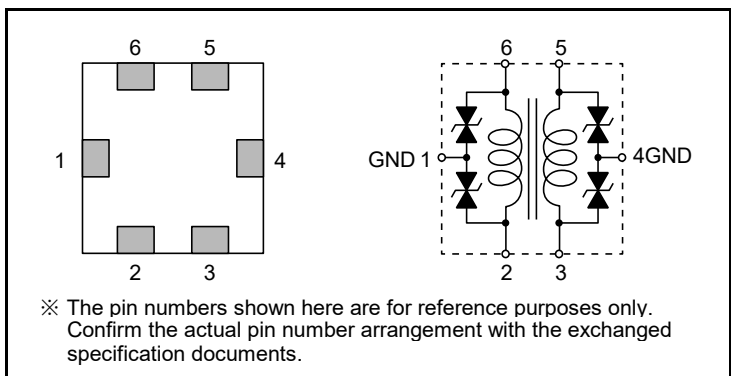

Dimensions in mm (not to scale)

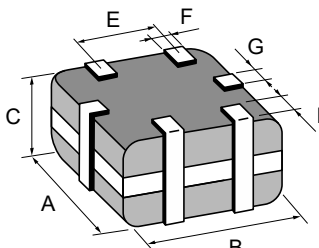

Part No. (inch size)	Dimensions							Mass (Weight) (mg/ pc.)
	A	B	C	D	E	F	G	
EXC24CS (0504)	1.25 ± 0.15	1.00 ± 0.15	0.50 ± 0.10	0.20 ± 0.15	0.55 ± 0.10	0.30 ± 0.10	0.20 ± 0.10	2.4

Unit : mm

Ratings

Part number	Impedance (Ω) at 100 MHz		Rated voltage (V) DC	Rated current (mA) DC	DC resistance (Ω) max.
	Common mode	Differential mode			
EXC24CS350U	35 Ω \pm 30 %	15 Ω max.	5	100	2.0
EXC24CS900U	90 Ω \pm 20 %	20 Ω max.	5	100	3.0

● Category temperature range -40°C to $+85^{\circ}\text{C}$

Impedance characteristics (Typical)

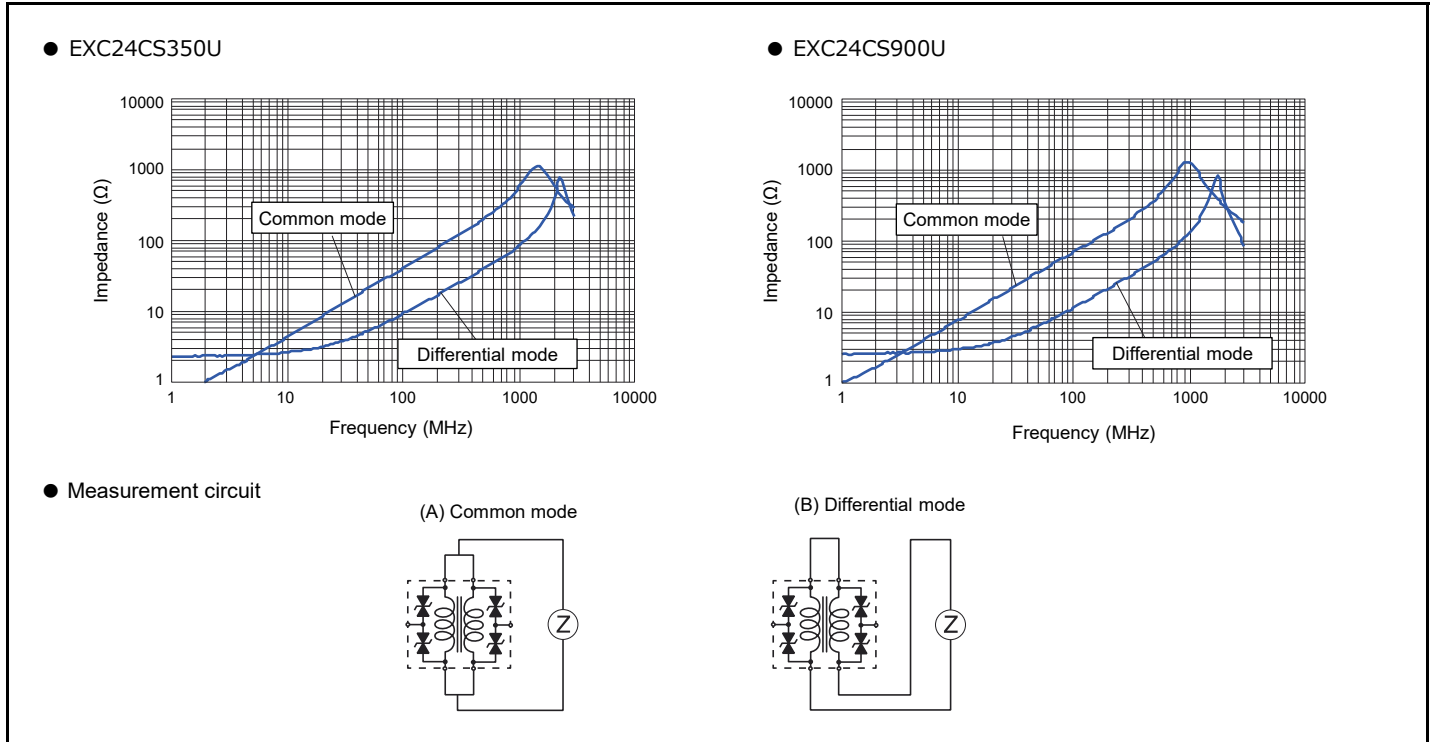

ESD suppression characteristics (Typ. : IEC6100-4-2, 8 kV contact discharge)

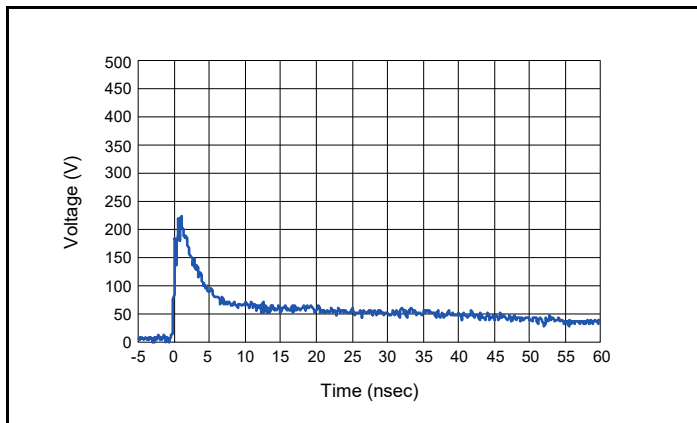

Recommended land pattern design (not to scale)

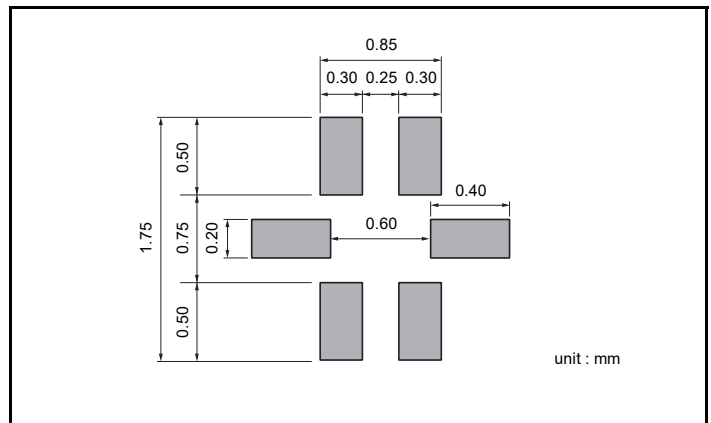

■ As for packaging methods, soldering conditions and safety precautions, please see data files

 This series is not recommended for new design. Click [here](#) for replacement.

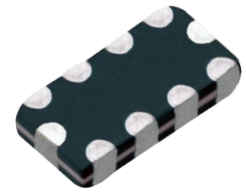

Common Mode Noise Filters Array

With ESD Suppressor

EXC18CS type

Features

- Provides EMI Filtering and ESD Protection (L 1.6 mm ×W 0.8 mm×H 0.4 mm)
- ESD and noise suppression of high-speed differential transmission lines with little influence of waveform rounding on signal transmission
- High Common mode attenuation in the range between 700 MHz and 1000 MHz (RF band)
- Strong multilayer/sintered structure, excellent reflow resistance and high mounting reliability
- Lead, halogen and antimony-free
- RoHS compliant

Recommended applications

- Smartphones, Tablet PCs and DSC
- ESD and noise suppression of high-speed differential data lines such as MIPI and USB

Explanation of part numbers

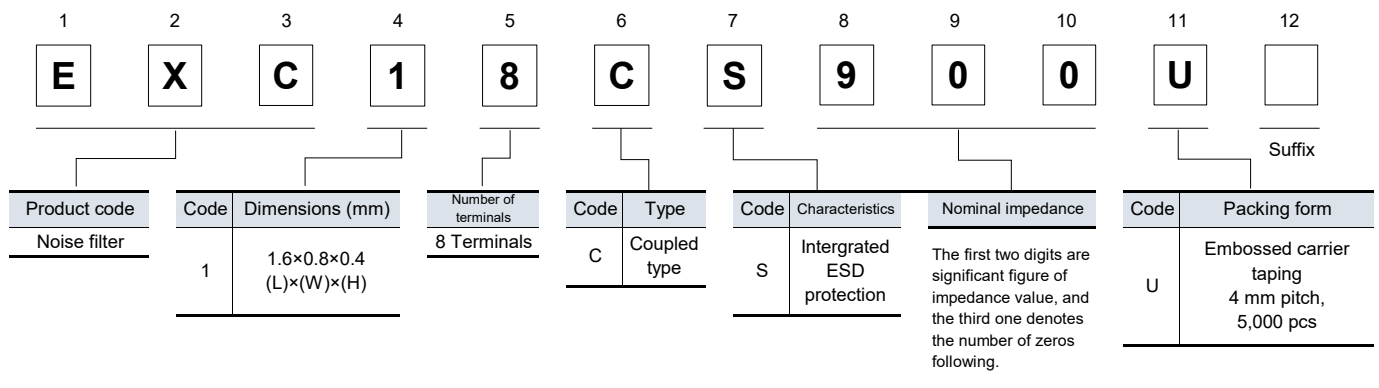

Construction

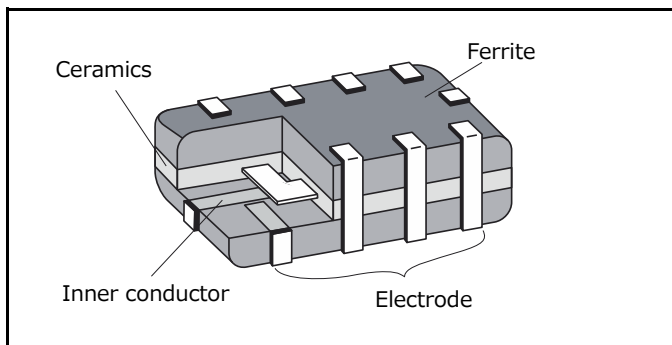

Circuit configuration (No polarity)

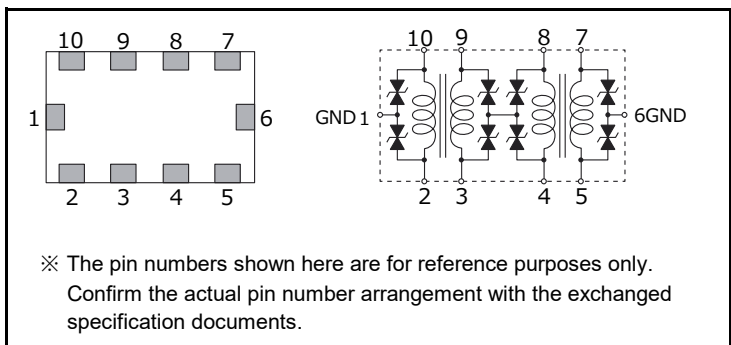

Dimensions in mm (not to scale)

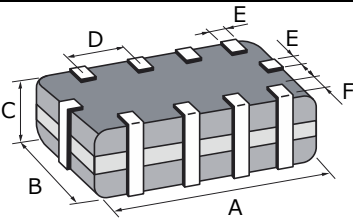

Part No. (inch size)	Dimensions						Mass (Weight) (mg/ pc.)
	A	B	C	D	E	F	
EXC18CS (0603)	1.6 ± 0.1	0.8 ± 0.1	0.4 ± 0.1	0.4 ± 0.1	0.2 ± 0.1	0.2 ± 0.1	1.9

単位 : mm

Ratings

Part number	Impedance (Ω) at 100 MHz		Rated voltage (V) DC	Rated current (mA) DC	DC resistance (Ω) max.
	Common mode	Differential mode			
EXC18CS350U	$35 \Omega \pm 30 \%$	15Ω max.	5	100	$1.8 \pm 30 \%$
EXC18CS900U	$90 \Omega \pm 20 \%$	20Ω max.	5	100	$3.0 \pm 30 \%$

● Category temperature range $-40\text{ }^{\circ}\text{C}$ to $+85\text{ }^{\circ}\text{C}$

Impedance characteristics (Typical)

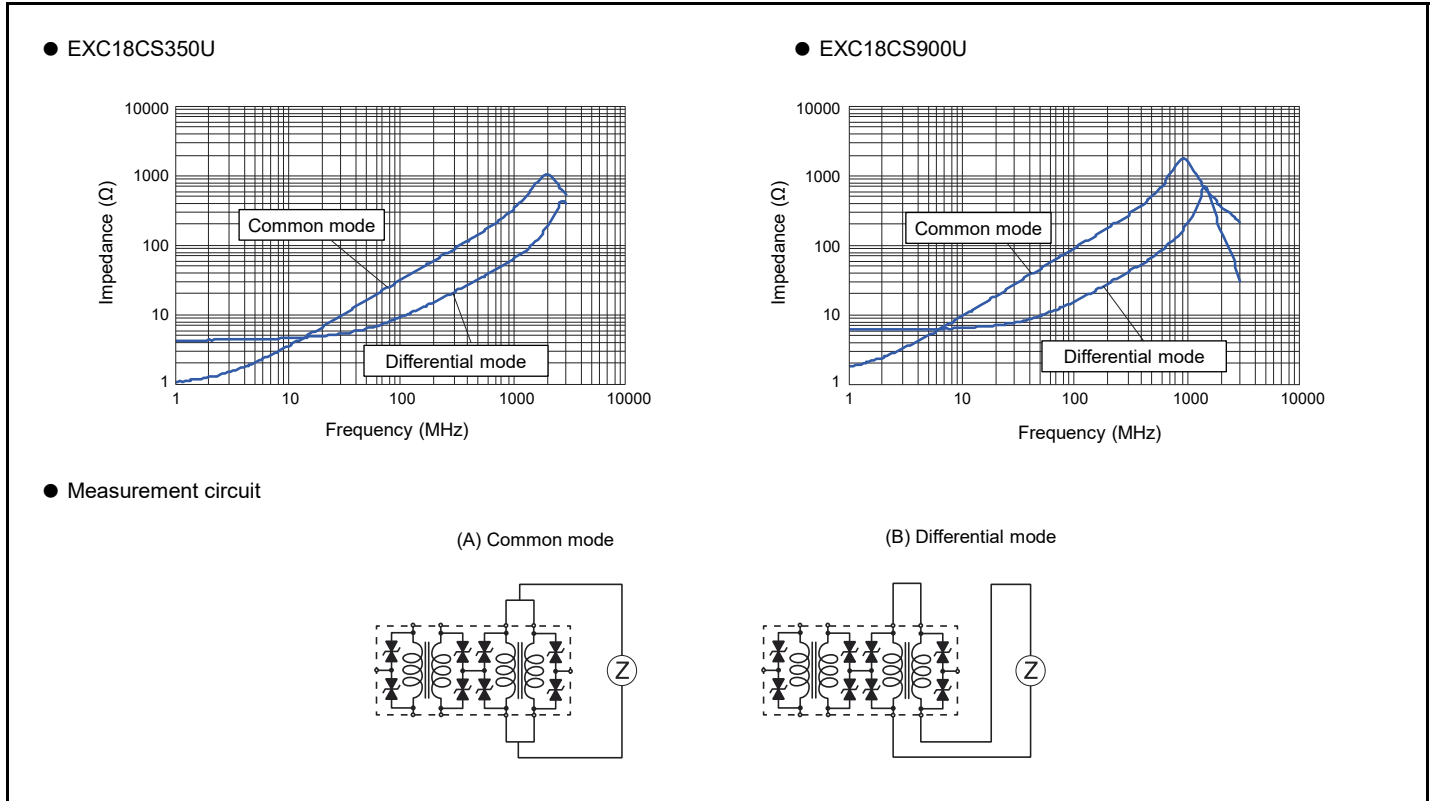

ESD suppression characteristics (Typ. : IEC6100-4-2, 8 kV contact discharge)

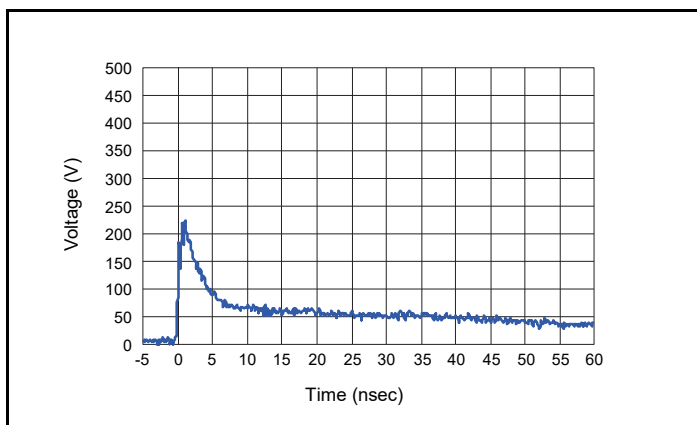

Recommended land pattern design (not to scale)

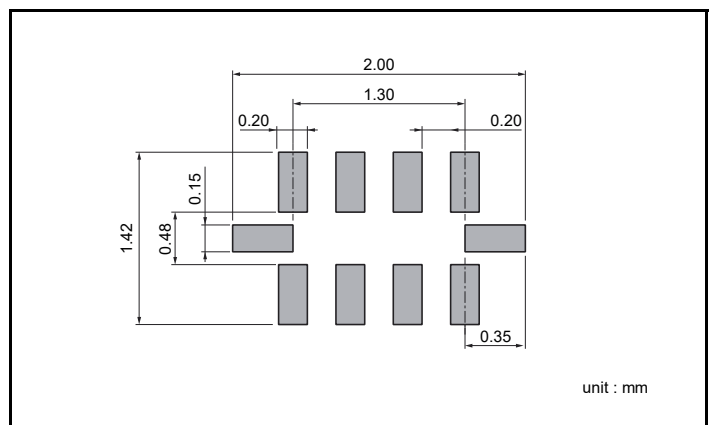

■ As for packaging methods, soldering conditions and safety precautions, please see data files

Common Mode Noise Filters with ESD Suppressor / Packaging methods

Packaging methods (Taping)

● Standard quantity

Part number	Size (inch)	Type	Kind of taping	Pitch (P_1) (mm)	Quantity (pcs / reel)
EXC14CS	0302	Single	Embossed carrier taping	2	10000
EXC24CS	0504			4	5000
EXC18CS	0603	Array			

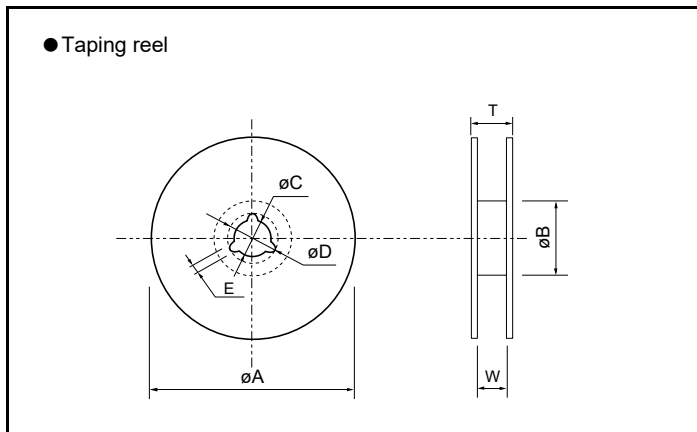
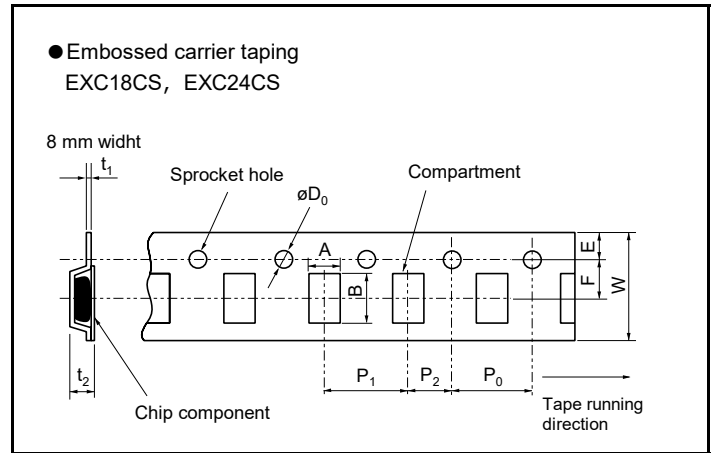
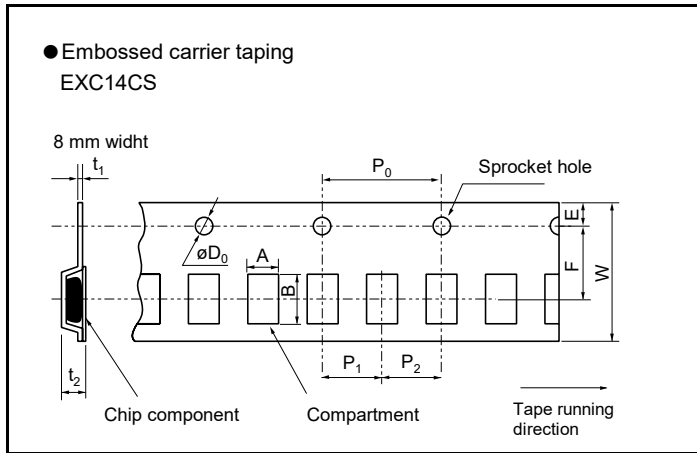

Embossed carrier taping

Unit : mm

Part number	A	B	W	F	E	P_1	P_2	P_0	ϕD_0	t_1	t_2
EXC14CS	0.75 ± 0.10	0.95 ± 0.10	8.0 ± 0.2	3.50 ± 0.05	1.75 ± 0.10	2.0 ± 0.1	2.0 ± 0.1	4.0 ± 0.1	$1.5 \begin{smallmatrix} +0.1 \\ 0 \end{smallmatrix}$	0.25 ± 0.05	0.85 ± 0.15
EXC18CS	1.00 ± 0.10	1.80 ± 0.10	8.0 ± 0.2	3.5 ± 0.1	1.75 ± 0.10	4.0 ± 0.1	2.0 ± 0.1	4.0 ± 0.1	$1.5 \begin{smallmatrix} +0.1 \\ 0 \end{smallmatrix}$	0.25 ± 0.05	0.50 ± 0.05
EXC24CS	1.20 ± 0.15	1.45 ± 0.15									0.90 ± 0.15

Standard reel dimensions

Unit : mm

Part number	ϕA	ϕB	ϕC	ϕD	E	W	T
EXC14CS	180.0 ± 3.0	60.0 ± 1.0	13.0 ± 0.5	21.0 ± 0.8	2.0 ± 0.5	9.0 ± 0.3	11.4 ± 1.5
EXC18CS							
EXC24CS							

Recommended soldering conditions

Recommendations and precautions are described below

● Recommended soldering conditions for reflow

- Reflow soldering shall be performed a maximum of two times.
- Please contact us for additional information when used in conditions other than those specified.
- Please measure the temperature of the terminals and study every kind of solder and printed circuit board for solderability before actual use.

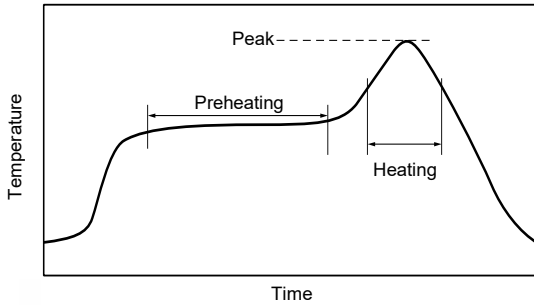

For soldering (Example : Sn-37Pb)

	Temperature	Time
Preheating	140 °C to 160 °C	60 s to 120 s
Main heating	Above 200 °C	30 s to 40 s
Peak	235 ± 10 °C	max. 10 s

For lead-free soldering (Example : Sn-3Ag-0.5Cu)

	Temperature	Time
Preheating	150 °C to 170 °C	60 s to 120 s
Main heating	Above 230 °C	30 s to 40 s
Peak	max. 260 °C	max. 10 s

● Flow soldering

- We do not recommend flow soldering, because flow soldering may cause bridges between the electrodes.

《Repair with hand soldering》

- Preheat with a blast of hot air or similar method. Use a soldering iron with a tip temperature of 350 °C or less.
Solder each electrode for 3 seconds or less.
- Never touch this product with the tip of a soldering iron.

Replacement list for “Not recommended for new design”

* If you are using any of the following models on the deleted list,
please substitute them with the suggested alternative model as soon as possible.

Non-recommended part number				Replacement part number							
Common Mode Noise Filters with ESD Suppressor				Common Mode Noise Filters				ESD Suppressor			Combination pattern
Part number	Inch size	ESD protection element	Impedance (Common Mode)	Part number	Inch size	Impedance (Common Mode)	Number of pieces	Part number	Inch size	Number of pieces	
EXC14CS350U	0302	2 line	35 Ω	EXC14CH350U	0302	35 Ω	1	EZAEG1N50AC	0201	2	①
				EXC14CH350U	0302	35 Ω	1	EZAEG2N50AX	0402	2	②
EXC14CS900U	0302		90 Ω	EXC14CE900U	0302	90 Ω	1	EZAEG1N50AC	0201	2	① ^{*1}
				EXC14CE900U	0302	90 Ω	1	EZAEG2N50AX	0402	2	② ^{*1}
			EXC24CH900U	0504	90 Ω	1	EZAEG1N50AC	0201	2	③	
			EXC24CH900U	0504	90 Ω	1	EZAEG2N50AX	0402	2	④	
EXC24CS350U	0504		35 Ω	EXC24CH500U	0504	50 Ω	1	EZAEG1N50AC	0201	2	①
				EXC24CH500U	0504	50 Ω	1	EZAEG2N50AX	0402	2	②
				EXC24CE360UP	0504	36 Ω	1	EZAEG1N50AC	0201	2	③ ^{*1}
				EXC24CE360UP	0504	36 Ω	1	EZAEG2N50AX	0402	2	④ ^{*1}
EXC24CS900U	0504		90 Ω	EXC24CH900U	0504	90 Ω	1	EZAEG1N50AC	0201	2	①
				EXC24CH900U	0504	90 Ω	1	EZAEG2N50AX	0402	2	②
EXC18CS350U	0603	4 line	35 Ω	EXC14CH350U	0302	35 Ω	2	EZAEG1N50AC	0201	4	① ^{*2}
				EXC14CH350U	0302	35 Ω	2	EZAEG2N50AX	0402	4	② ^{*2}
EXC18CS900U	0603		90 Ω	EXC18CE900U	0603	90 Ω	1	EZAEG1N50AC	0201	4	① ^{*1}
				EXC18CE900U	0603	90 Ω	1	EZAEG2N50AX	0402	4	② ^{*1}
				EXC24CH900U	0504	90 Ω	2	EZAEG1N50AC	0201	4	③ ^{*2}
				EXC24CH900U	0504	90 Ω	2	EZAEG2N50AX	0402	4	④ ^{*2}

*1: USB2.0, LVDS(<1Gbps) only

*2: No replacement part number for Array products

Common Mode Noise Filters

2 Mode Noise Filters

EXC14CP type



Features

- Small size and low-profile : 0302 inch size (L 0.85 mm×W 0.65 mm×H 0.45 mm)
- Burst/radiation noise filtering for audio circuits
- The optimally magnetic-coupled ferrite beads allow for the filtering of both common and normal mode noises
- The strong multi-layer structure provides high resistance to reflow soldering heat and a high mounting reliability
- RoHS compliant

Recommended applications

- Smart phones, Tablet PCs, DSC and Portable Music Player
- Noise suppression of burst noise of Receiver/Microphone and D-class power amplifier

Explanation of part numbers

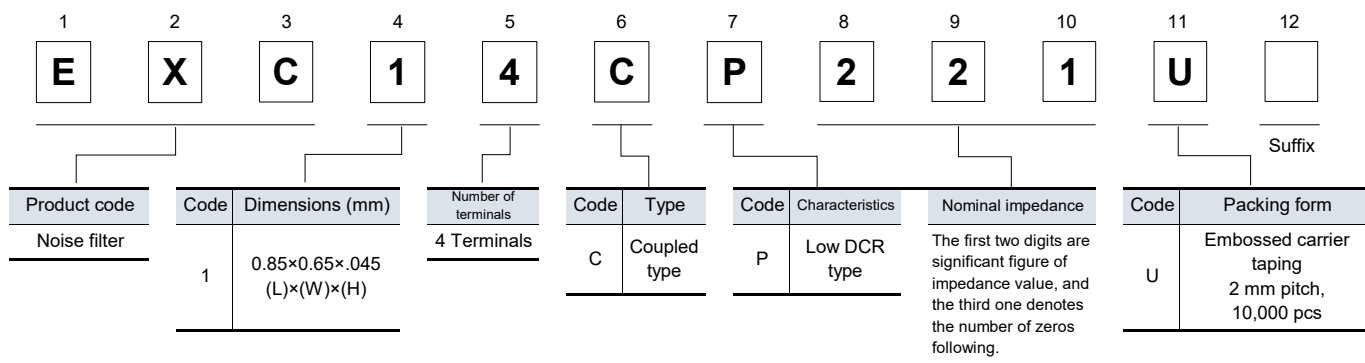

Construction

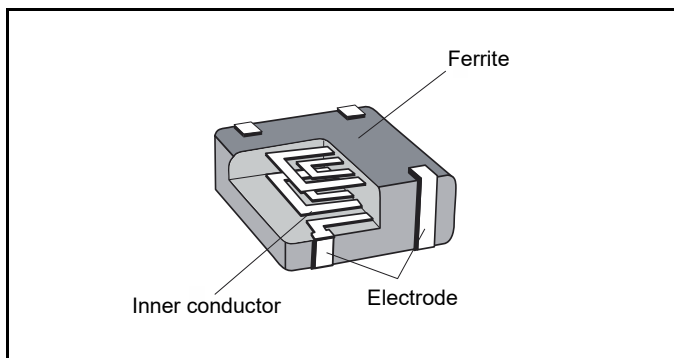

Circuit configuration (No polarity)

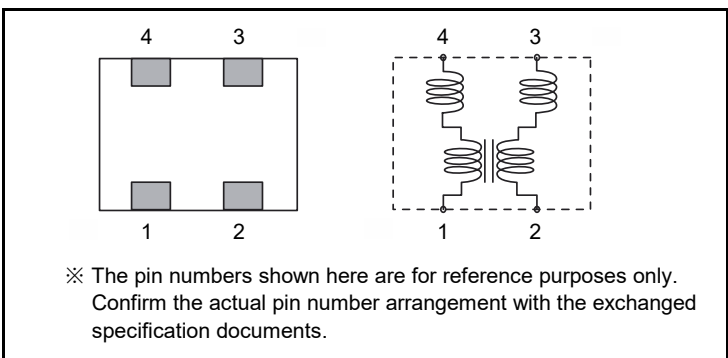

Dimensions in mm (not to scale)

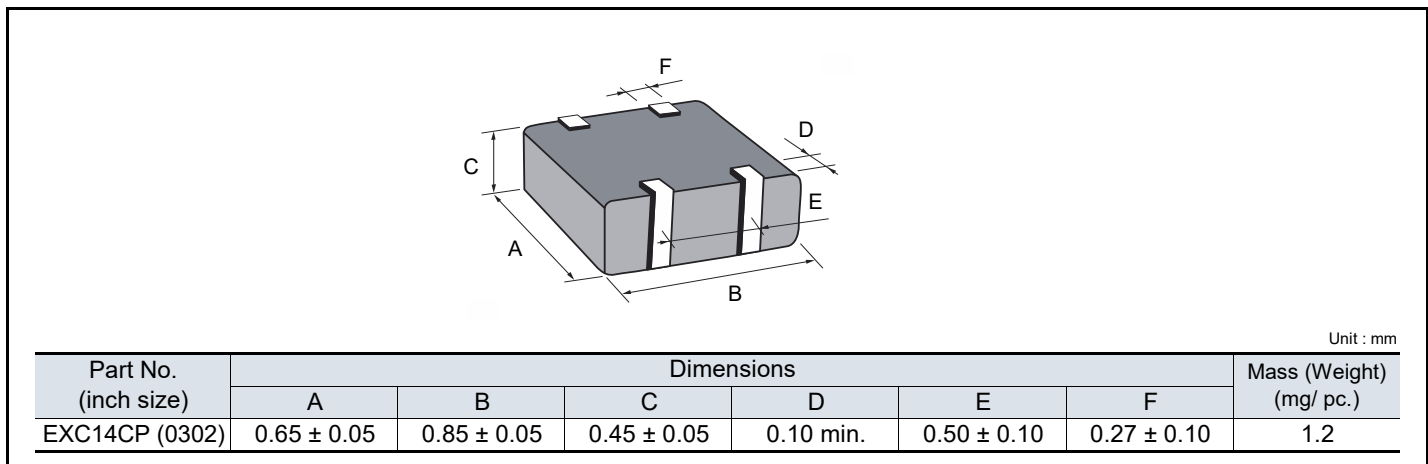

Ratings

Part number	Impedance (Ω) at 100 MHz		Rated voltage (V) DC	Rated current (mA) DC	DC resistance (Ω) max.
	Open mode	Common mode			
EXC14CP121U	120 $\Omega \pm 30\%$	75 $\Omega \pm 25\%$	5	300	0.5
EXC14CP221U	220 $\Omega \pm 30\%$	140 $\Omega \pm 25\%$		200	0.7

● Category temperature range $-40\text{ }^{\circ}\text{C}$ to $+85\text{ }^{\circ}\text{C}$

Impedance characteristics (Typical)

● EXC14CP121U

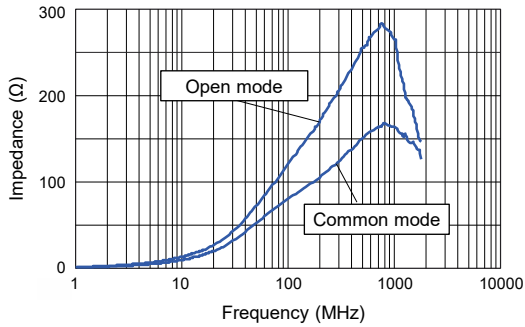

● EXC14CP221U

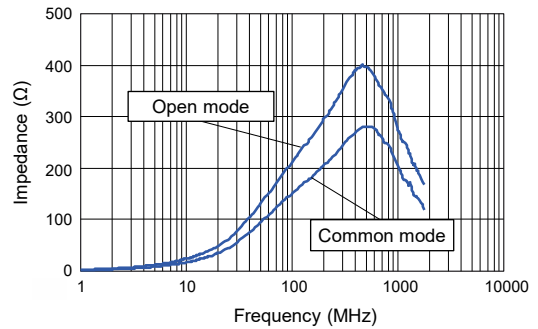

● Measurement circuit

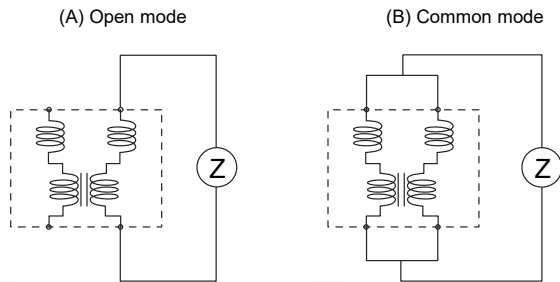

■ As for packaging methods, soldering conditions and safety precautions, please see data files



Common Mode Noise Filters

2 Mode Noise Filters

EXC24CB/CP/CN type

Features

- Burst/radiation noise filtering for audio circuits
- The optimally magnetic-coupled ferrite beads allow for the filtering of both common and normal mode noises
- The strong multi-layer structure provides high resistance to reflow soldering heat and a high mounting reliability
- Magnetic shield type
- High Impedance : 220 to 1 k Ω (EXC24CB type)
- Low Resistance Value : 0.4 Ω max. (EXC24CP type)
- High Impedance : 600 Ω , Low Resistance Value : 0.9 Ω max. (EXC24CN type)
- RoHS compliant

Recommended applications

- Smart phones, Tablet PCs, DSC and Portable Music Player
- Noise suppression of burst noise of Receiver/Microphone and D-class power amplifier

Explanation of part numbers

- EXC24 CB/CP type

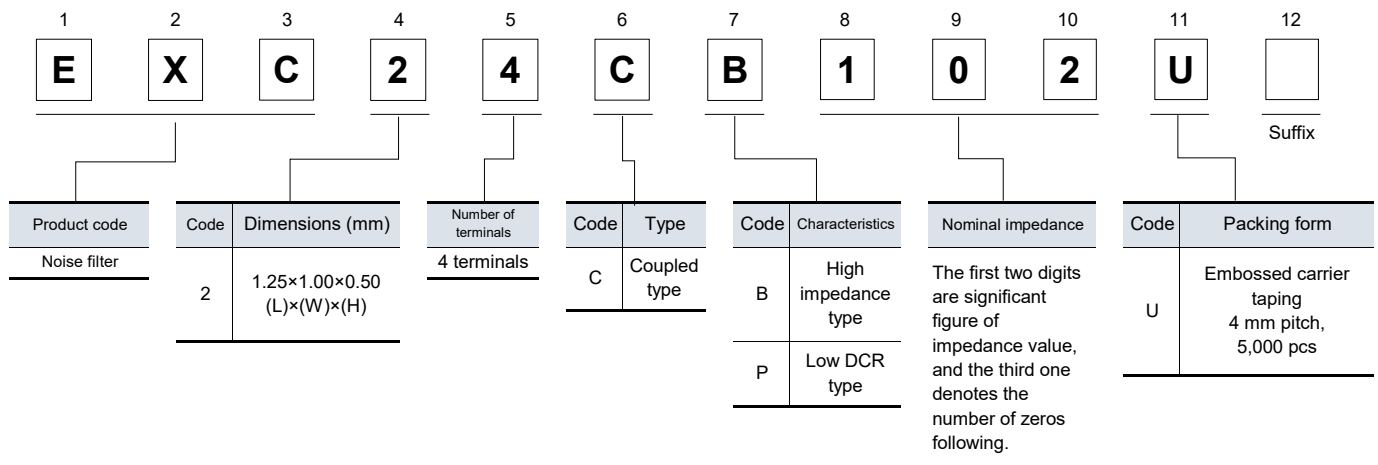

- EXC24 CN type

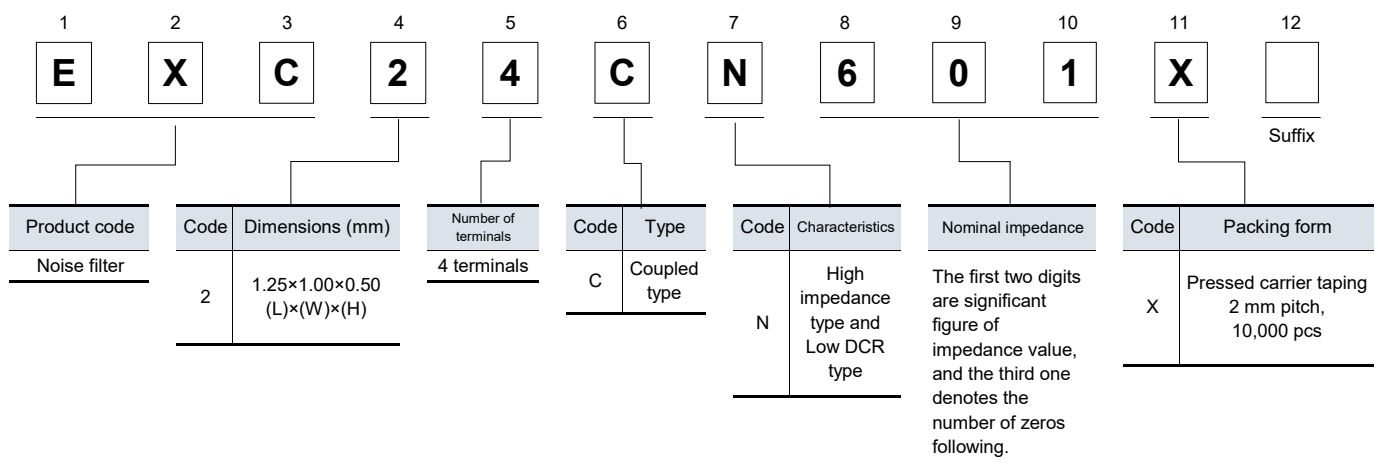

2 Mode Noise Filters EXC24CB/CP/CN type

Construction

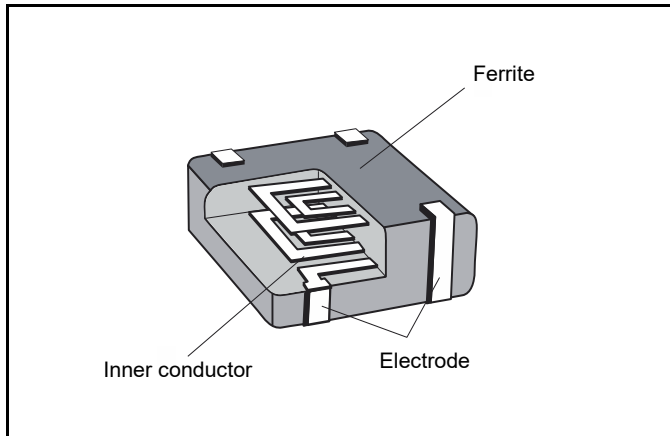

Circuit configuration (No polarity)

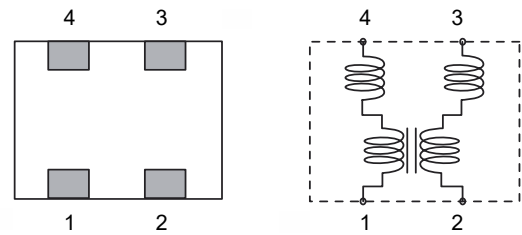

※ The pin numbers shown here are for reference purposes only.
Confirm the actual pin number arrangement with the exchanged specification documents.

Dimensions in mm (not to scale)

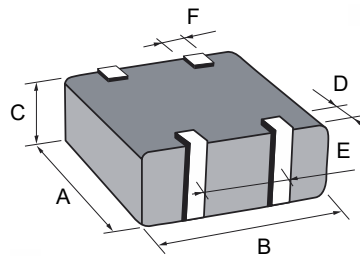

Unit : mm

Part No. (inch size)	Dimensions						Mass (Weight) (mg/ pc.)
	A	B	C	D	E	F	
EXC24C	1.00 ± 0.15	1.25 ± 0.15	0.50 ± 0.10	0.20 ± 0.15	0.65 ± 0.10	0.35 ± 0.10	3.0

Ratings

Part number	Impedance (Open mode)		Rated voltage (V) DC	Rated current (mA) DC	DC resistance (Ω) max.
	(Ω) at 100 MHz	Tolerance (%)			
EXC24CP121U	120	± 25	5	500	0.3
EXC24CP221U	220			350	0.4
EXC24CB221U	220			100	0.7
EXC24CB102U	1000			50	1.5

Part number	Impedance (Common mode)		Rated voltage (V) DC	Rated current (mA) DC	DC resistance (Ω) max.
	(Ω) at 100 MHz	Tolerance (%)			
EXC24CN601X	600	± 25	5	200	0.9

● Category temperature range -40 °C to +85 °C

Impedance characteristics (Typical)

● EXC24CP121U

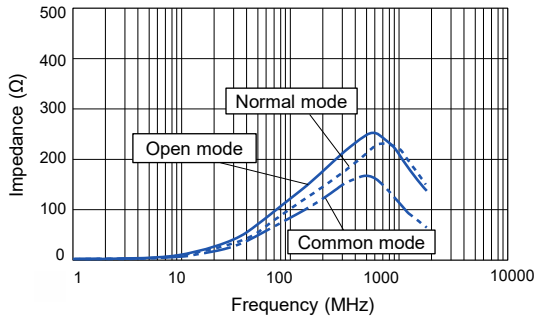

● EXC24CP221U

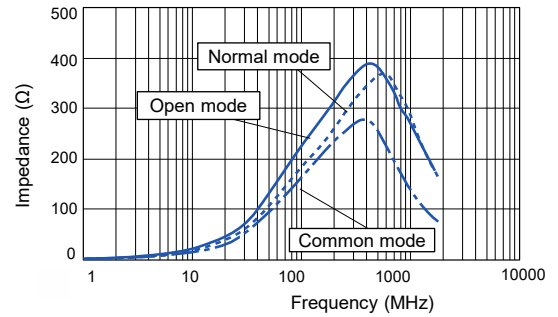

● EXC24CB221U

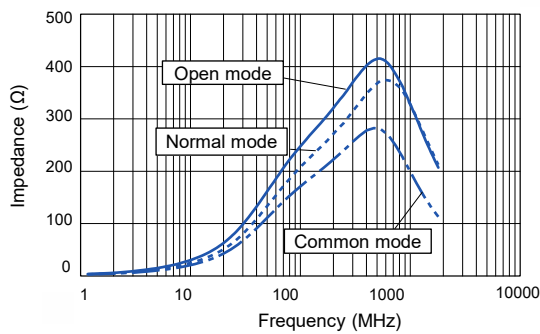

● EXC24CB102U

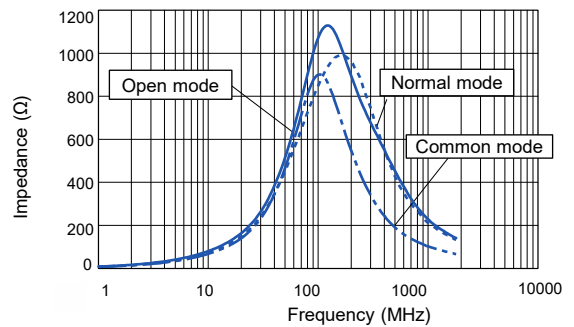

● Measurement circuit

(A) Open mode

(B) Common mode

(C) Normal mode

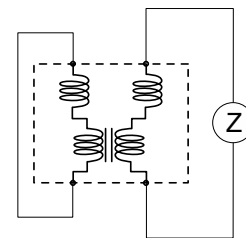
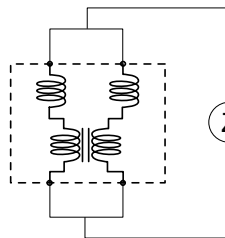
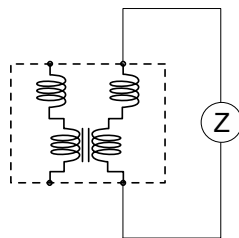

Impedance characteristics (Typical)

● EXC24CN601X

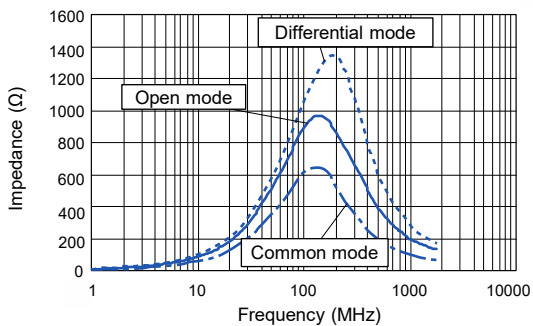

● Measurement circuit

(A) Open mode

(B) Common mode

(C) Differential mode

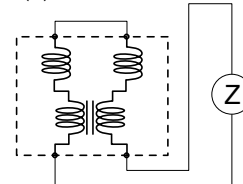
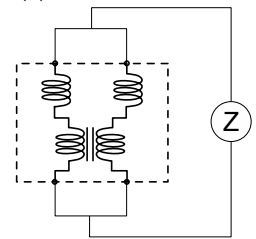
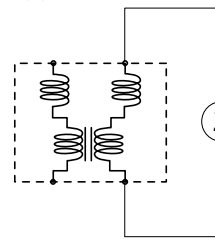

■ As for packaging methods, soldering conditions and safety precautions, please see data files

Packaging methods (Taping)

● Standard quantity

Part number	Size (inch)	Kind of taping	Pitch (P ₁) (mm)	Quantity (pcs / reel)
EXC14CP□□□U	0302	Embossed carrier taping	2	10,000
EXC24CP/CB□□□U	0504		4	5,000
EXC24CN□□□X	0504	Pressed carrier taping	2	10,000

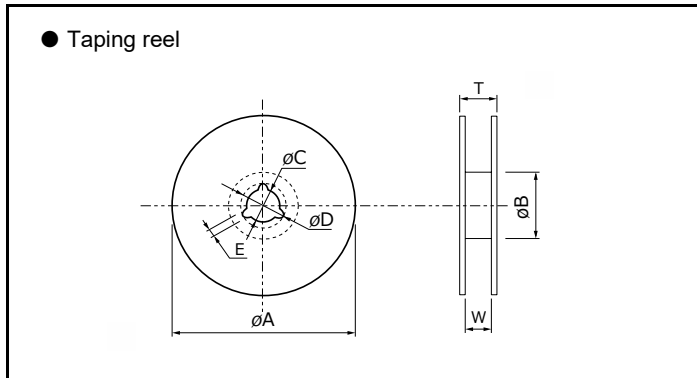
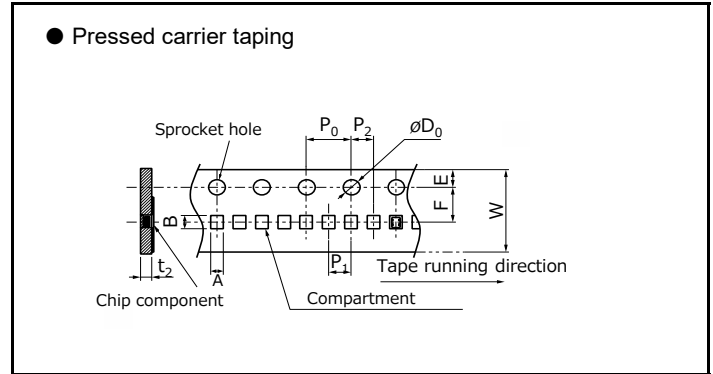
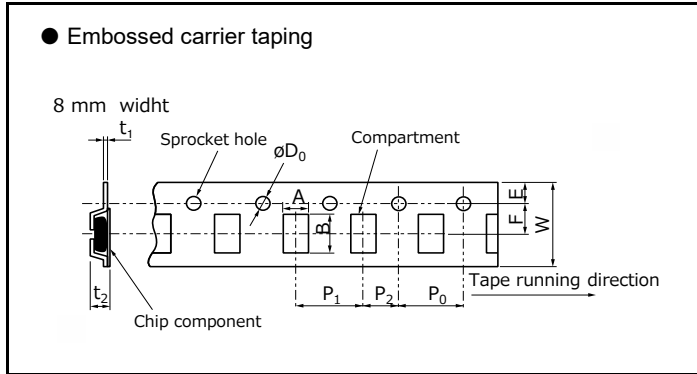

● Embossed carrier dimensions

Unit : mm

Part number	A	B	W	F	E	P ₁	P ₂	P ₀	øD ₀	t ₁	t ₂
EXC14CP	0.75±0.10	0.95±0.10	8.0±0.2	3.50±0.05	1.75±0.10	2.0±0.1	2.0±0.1	4.0±0.1	1.5 ^{+0.1} ₀	0.25±0.05	0.85±0.15
EXC24CP	1.20±0.15	1.45±0.15	8.0±0.2	3.50±0.10	1.75±0.10	4.0±0.1	2.0±0.1	4.0±0.1	1.5 ^{+0.1} ₀	0.25±0.05	0.90±0.15
EXC24CB											

● Pressed carrier dimensions

Unit : mm

Part number	A	B	W	F	E	P ₁	P ₂	P ₀	øD ₀	t ₂
EXC24CN	1.14±0.10	1.38±0.15	8.0±0.2	3.5±0.1	1.75±0.10	2.0±0.1	2.0±0.1	4.0±0.1	1.5 ^{+0.1} ₀	0.68±0.10

● Standard reel dimensions

Unit : mm

Part number	øA	øB	øC	øD	E	W	T
EXC14C	180.0±3.0	60.0±1.0	13.0±0.5	21.0±0.8	2.0±0.5	9.0±0.3	11.4±1.5
EXC24C							

Recommended land pattern design

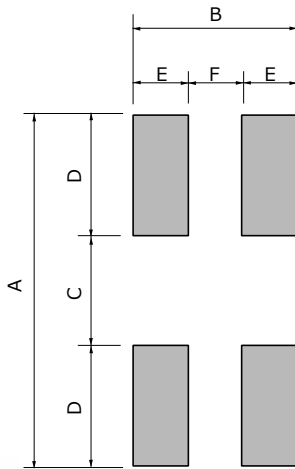

Unit : mm

Part number	Dimensions					
	A	B	C	D	E	F
EXC14CP	0.80 to 1.00	0.80	0.30	0.25 to 0.35	0.30	0.20
EXC24CP	1.50 to 1.90	1.10	0.50	0.50 to 0.70	0.40	0.30
EXC24CB						
EXC24CN						

Recommended soldering conditions

Recommendations and precautions are described below

● Recommended soldering conditions for reflow

- Reflow soldering shall be performed a maximum of two times.
- Please contact us for additional information when used in conditions other than those specified.
- Please measure the temperature of the terminals and study every kind of solder and printed circuit board for solderability before actual use.

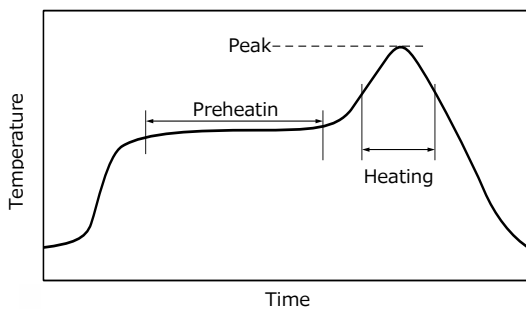

● Flow soldering

- We do not recommend flow soldering, because flow soldering may cause bridges between the electrodes.

For soldering (Example : Sn-37Pb)

	Temperature	Time
Preheating	140 °C to 160 °C	60 s to 120 s
Main heating	Above 200 °C	30 s to 40 s
Peak	235 ± 10 °C	max. 10 s

For lead-free soldering (Example :Sn-3Ag-0.5Cu)

	Temperature	Time
Preheating	150 °C to 170 °C	60 s to 120 s
Main heating	Above 230 °C	30 s to 40 s
Peak	max. 260 °C	max. 10 s

«Repair with hand soldering»

- Preheat with a blast of hot air or similar method. Use a soldering iron with a tip temperature of 350 °C or less. Solder each electrode for 3 seconds or less.
- Never touch this product with the tip of a soldering iron.

Common Mode Noise Filters / Common performance

Performance		
Test item	Performance requirements	Test conditions resistance
Resistance	Within specified tolerance	25 °C
Overload	—	Rated voltage
Resistance to soldering heat	±30 % (Impedance change)	260 °C, 10 s
Rapid change of temperature	±30 % (Impedance change)	-40 °C (30 min.) / +85 °C (30 min.), 200 cycles
High temperature exposure	±30 % (Impedance change)	85 °C , 500 h
Damp heat, Steady state	±30 % (Impedance change)	60 °C, 95 %RH, 500 h
Load life in humidity	±30 % (Impedance change)	60 °C, 95 %RH, Rated current, 500 h

⚠ Application Guidelines (ESD Suppressor)

1. Safety precautions

- Make sure to exchange product specifications before using this product, regardless of the intended use.
The design and specifications in this catalog are subject to change without prior notice.
- Do not use the products beyond the specifications described in this catalog.
- This catalog explains the quality and performance of the products as individual components. Before use, check and evaluate their operations when installed in your products.
- If a malfunction of this product may result in the loss of human life or other serious damage in transportation equipment (trains, automobiles, ships, etc.), signaling equipment, medical equipment, aerospace equipment, electric heating equipment, combustion and gas equipment, rotating equipment, disaster prevention and security equipment, and other equipment, ensure safety by implementing a fail-safe design with the following system.
 - * Systems equipped with a protection circuit and a protection device.
 - * Systems equipped with a redundant circuit or other system to prevent an unsafe status in the event of a single fault.

2. Precautions for use

- These products are designed and manufactured for general and standard use in general electronic equipment (e.g. AV equipment, home electric appliances, office equipment, information and communication equipment)
If the product is to be used in an application that requires special quality and reliability and where failure or malfunction of the product may directly threaten human life or cause bodily harm (e.g., aerospace equipment, transportation equipment, combustion equipment, medical equipment, disaster prevention and security equipment, safety devices, etc.), be sure to consult with our sales office in advance and exchange product specifications appropriate for the application.
- These products are not intended for use in the following special conditions. Before using the products, carefully check the effects on their quality and performance, and determine whether or not they can be used.
 1. In liquid, such as water, oil, chemicals, or organic solvent.
 2. In direct sunlight, outdoors, or in dust.
 3. In salty air or air with a high concentration of corrosive gas, such as Cl_2 , H_2S , NH_3 , SO_2 , or NO_x .
 4. Electric Static Discharge (ESD) Environment.
These components are sensitive to static electricity and can be damaged under static shock (ESD).
Please take measures to avoid any of these environments.
Smaller components are more sensitive to ESD environment.
 5. Electromagnetic and Radioactive Environment.
Avoid any environment where strong electromagnetic waves and radiation exist.
 6. In an environment where these products cause dew condensation.
 7. Sealing or coating of these products or a printed circuit board on which these products are mounted, with resin or other materials.
- These products generate Joule heat when energized. Carefully position these products so that their heat will not affect the other components.
- Carefully position these products so that their temperatures will not exceed the category temperature range due to the effects of neighboring heat-generating components. Do not mount or place heat-generating components or inflammables, such as vinyl-coated wires, near these products.
- Note that non-cleaning solder, halogen-based highly active flux, or water-soluble flux may deteriorate the performance or reliability of the products.
- Carefully select a flux cleaning agent for use after soldering. An unsuitable agent may deteriorate the performance or reliability. In particular, when using water or a water-soluble cleaning agent, be careful not to leave water residues. Otherwise, the insulation performance may be deteriorated.
- Do not apply flux to these products after soldering. The activity of flux may be a cause of failures in these products.
- Refer to the recommended soldering conditions and set the soldering condition. High peak temperature or long heating time may impair the performance or the reliability of these products.
- Recommended soldering condition is for the guideline for ensuring the basic characteristics of the products, not for the stable soldering conditions. Conditions for proper soldering should be set up according to individual conditions.
- Do not reuse any products after removal from mounting boards.
- Do not drop these products. If these products are dropped, do not use them. Such products may have received mechanical or electrical damage.
- If any doubt or concern to the safety on these products arise, make sure to inform us immediately and conduct technical examinations at your side.

3. Precautions for storage

The performance of these products, including the solderability, is guaranteed for a year from the date of arrival at your company, provided that they remain packed as they were when delivered and stored at a temperature of -5 °C to +40 °C and a relative humidity of 15 % to 75 %.

Even within the above guarantee periods, do not store these products in the following conditions. Otherwise, their electrical performance and/or solderability may be deteriorated, and the packaging materials (e.g. taping materials) may be deformed or deteriorated, resulting in mounting failures.

1. In salty air or in air with a high concentration of corrosive gas, such as Cl₂, H₂S, NH₃, SO₂, or NO_x.
2. In direct sunlight.

<Package markings>

Package markings include the product number, quantity, and country of origin.

In principle, the country of origin should be indicated in English.

4. Precaution specific to this product

1. If a large electric surge (especially, one which is larger than an ESD) is expected to be applied, be sure to test and confirm proper ESD Suppressor (hereafter called the suppressors) functionality when mounted on your board. When the applied load is more than the allowable rated power under normal load conditions, it may impair performance and/or the reliability of the suppressors. Never exceed the rated power. If the product will be used under these special conditions, be sure to contact a Panasonic representative first.
2. Do not use halogen-based or other high-activity flux. Otherwise, the residue may impair the suppressors' performance and/or reliability.
3. When soldering with a soldering iron, never touch the suppressors' bodies with the tip of the soldering iron. When using a soldering iron with a high temperature tip, finish soldering as quickly as possible (within three seconds at 350 °C max.).
4. If the amount of solder is too much or too little, the connection reliability and performance may be affected. Check the performance and reliability of the product and use the proper amount of solder.
5. When the suppressors' protective coatings are chipped, flawed, or removed, the characteristics of the suppressors may be impaired. Take special care not to apply mechanical shock during automatic mounting or cause damage during handling of the boards with the suppressors mounted
6. Do not apply shock to the suppressors or pinch them with a hard tool (e.g. pliers and tweezers). Otherwise, the suppressors' protective coatings and bodies may be chipped, affecting their performance.
7. Avoid excessive bending of printed circuit boards in order to protect the suppressors from abnormal stress.
8. Do not immerse the suppressors in solvent for a long time. Before using solvent, carefully check the effects of immersion.
9. Do not apply excessive tension to the terminals.

5. AEC-Q200 Compliant (ESD Suppressor, High withstanding:EZAEG3W type)

The products are tested based on all or part of the test conditions and methods defined in AEC-Q200.

Please consult with Panasonic for the details of the product specification and specific evaluation test results, etc., make sure to exchange product specifications for each product when placing an order.

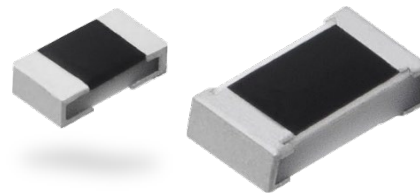

ESD Suppressor

EZAEG 2A, 3A type

- Don't use these products in the engine room.
- Don't use these products in any driving applications or any other critical functions that may affect passenger's safety. (e.g. Power train, ABS, Engine ECU, Air bag, and so on.)
- Don't use these products in applications related to the autonomous driving equipment with system level 3 or higher.

Features

- ESD protection of high-speed data lines
- Low capacitance [1005 (0402) size : 0.05 pF, 1608 (0603) size : 0.10 pF]
- Good ESD suppression characteristics
- Good ESD withstanding
- RoHS compliant

Recommended applications

- Smart phones, Mobile phones, RF Modules, NFC and GPS
- ESD suppression of high-speed differential data line such as Antenna circuit, HDMI, SATA, USB, Display Port

Explanation of part numbers

1	2	3	4	5	6	7	8	9	10	11
E	Z	A	E	G	2	A	5	0	A	X

Product code	Code	Dimensions (mm) (inch)	Code	Design specification	Code	Voltage	Code	Feature	Packing methods		
ESD Suppressor	2	1005 (0402)	A	Rated voltage 30 V	50	500 V	A	Standard	Code	Packaging	Part No.
	3	1608 (0603)							X	Pressed carrier taping 2 mm pitch, 10,000 pcs	EZAEG2A
									V	Punched carrier taping 4 mm pitch, 5,000 pcs	EZAEG3A

Construction

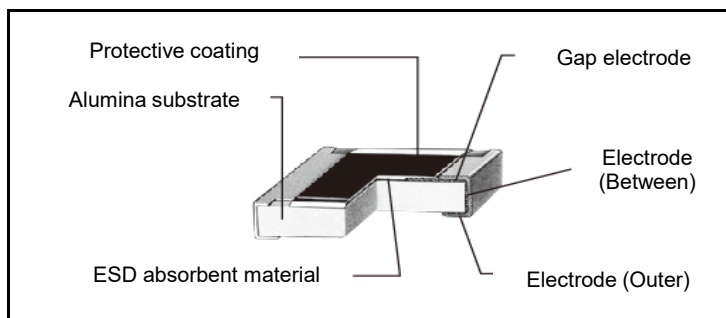

Circuit configuration

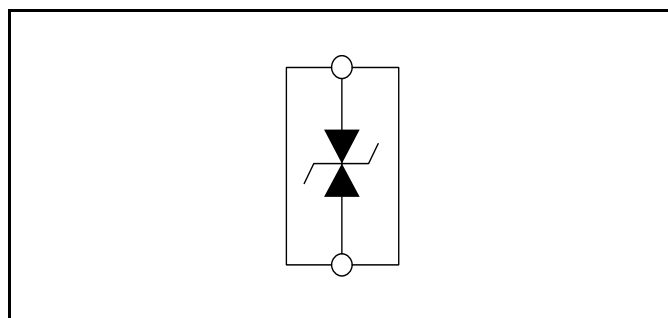

Dimensions (not to scale)

Part No. (inch size)	Dimensions					Mass (Weight) (g/1000 pcs)
	L	W	a	b	T	
EZAEG2A (0402)	1.00 ± 0.10	0.50 ± 0.05	0.20 ± 0.10	0.25 ± 0.10	0.38 ± 0.05	0.6
EZAEG3A (0603)	1.60 ± 0.15	0.80 ± 0.15	0.30 ± 0.20	0.30 ± 0.20	0.50 ± 0.10	2.2

Unit : mm

Ratings

Part number	Capacitance ^{*1} (pF)	Rated voltage	Category temperature range
EZAEG2A50AX	0.05 ^{+0.05} / _{-0.04}	30 V max.	-55 °C to +125 °C
EZAEG3A50AV	0.10 ^{+0.10} / _{-0.08}		

*1: Capacitance = The capacitance value shall be measured under the conditions specified below.

Frequency : 1 MHz ± 10 %, Voltage : 1 Vrms ± 0.2 Vrms, Temperature : 25 °C ± 2 °C

Performance

Test item	Performance requirements	Test conditions
Peak voltage	500 V max.	IEC61000-4-2, contact discharge 8 kV, Peak voltage value
Clamping voltage	100 V max.	IEC61000-4-2, contact discharge 8 kV, voltage at 30 ns after initiation of pulse
Leakage current	1 µA max.	Current at rated voltage (DC 30 V)
ESD withstanding	Leakage current 10 µA max.	IEC61000-4-2, contact discharge 8 kV, +/- 10 times
Rapid change of temperature		-55 °C (30 min.) / +125 °C (30 min.), 100 cycles
Load life in humidity		60 °C, 90 % to 95 %RH, Rated voltage, 1000 h
Endurance at 85 °C		85 °C, Rated voltage, 1000 h
Resistance to soldering heat		270 °C, 10 s

Frequency characteristics

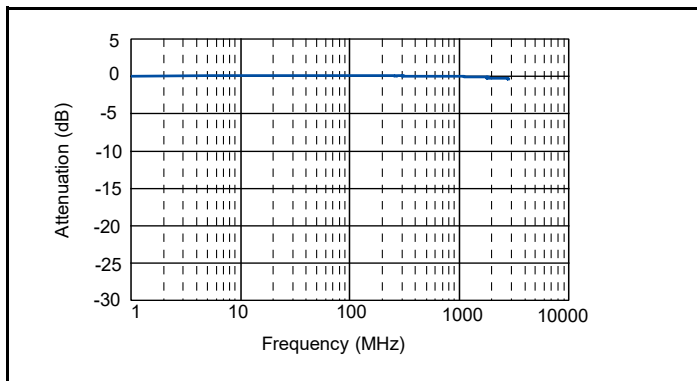

ESD Suppression voltage waveform

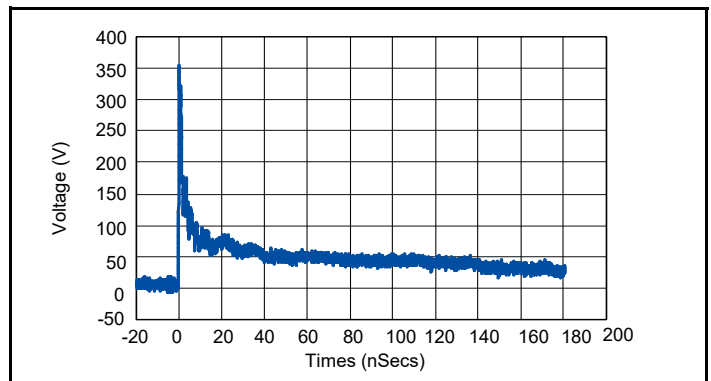

Typical circuits requiring protection

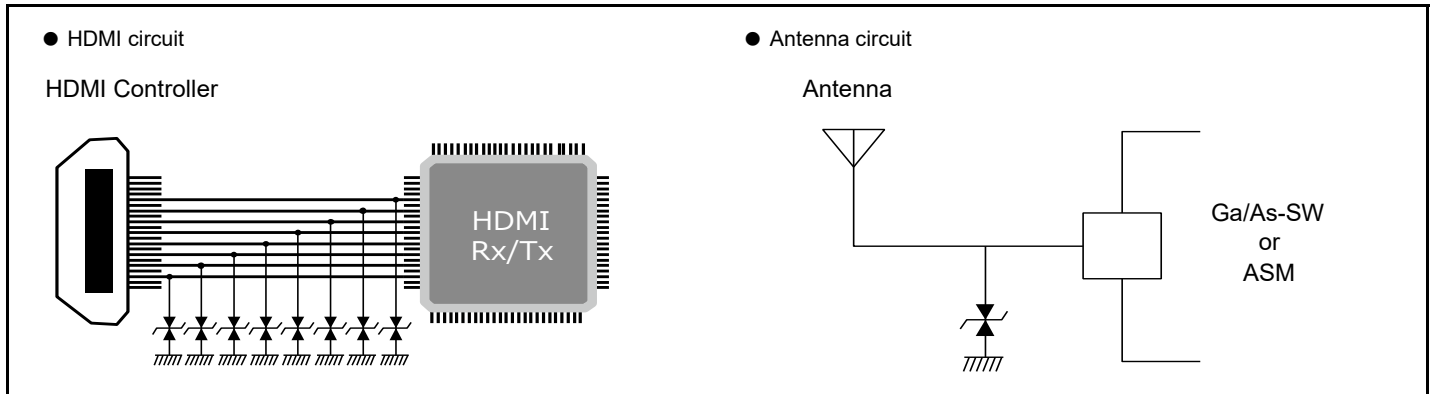

Recommended land pattern

Recommended land pattern design for ESD Suppressor is shown below.

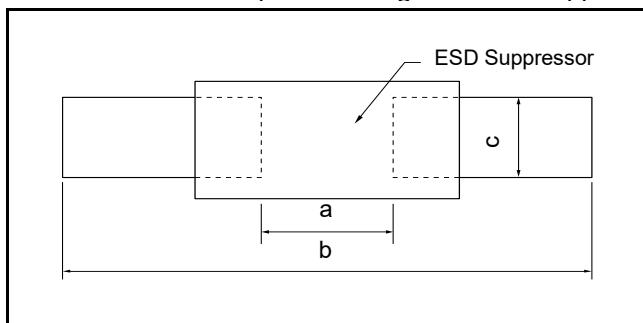

Unit : mm

Part number	Dimensions		
	a	b	c
EZAEG2A	0.5 to 0.6	1.4 to 1.6	0.4 to 0.6
EZAEG3A	0.7 to 0.9	2.0 to 2.2	0.8 to 1.0

■ As for packaging methods, soldering conditions and safety precautions, please see data files.

ESD Suppressor

EZAEG 1N, 2N type

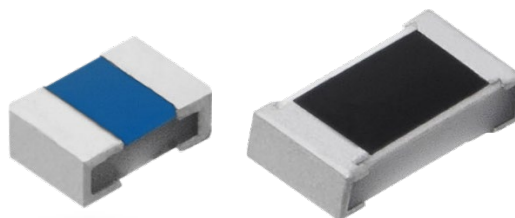

- Don't use these products in the engine room.
- Don't use these products in any driving applications or any other critical functions that may affect passenger's safety. (e.g. Power train, ABS, Engine ECU, Air bag, and so on.)
- Don't use these products in applications related to the autonomous driving equipment with system level 3 or higher.

Features

- Good ESD withstanding (IEC61000-4-2 15 kV contact/air Discharge)
- ESD protection of high-speed data lines
- Low capacitance [0603 (0201) size : 0.04 pF, 1005(0402) size : 0.05 pF]
- Good ESD suppression characteristics
- RoHS compliant

Recommended applications

- Smart phones, Mobile phones, RF Modules, NFC and GPS
- ESD suppression of high-speed differential data line such as Antena circuit, HDMI, SATA, USB, Display Port

Explanation of part numbers

1	2	3	4	5	6	7	8	9	10	11	
E	Z	A	E	G	2	N	5	0	A	X	
Product code ESD Suppressor	Code 1 2	Dimensions (mm) (inch) 0603 (0201) 1005 (0402)	Code N	Design specification ESD withstanding 15 kV, Rated voltage 30 V	Code 50	Voltage 500 V	Code A	Feature Standard	Code C X	Packaging Pressed carrier taping 2 mm pitch, 15,000 pcs Pressed carrier taping 2 mm pitch, 10,000 pcs	Part No. EZAEG1N EZAEG2N

Construction

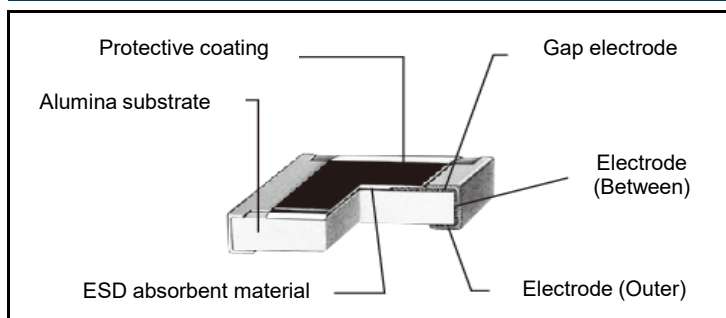

Circuit configuration

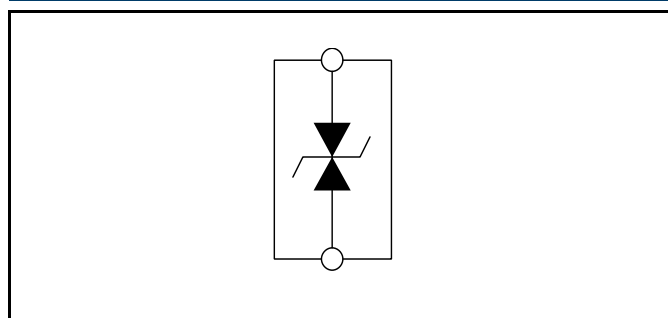

Dimensions (not to scale)

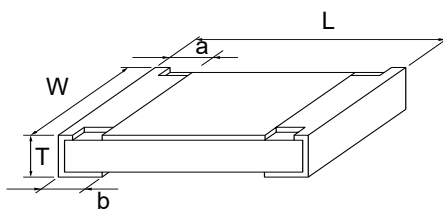

Unit : mm

Part No. (inch size)	Dimensions					Mass (Weight) (g/1000 pcs)
	L	W	a	b	T	
EZAEG1N (0201)	0.60 ± 0.03	0.30 ± 0.03	0.15 ± 0.10	0.15 ± 0.10	0.23 ± 0.03	0.12
EZAEG2N (0402)	1.00 ± 0.10	0.50 ± 0.05	0.20 ± 0.10	0.27 ± 0.10	0.38 ± 0.05	0.60

Ratings

Part number	Capacitance *1 (pF)	Rated voltage	Category temperature range
EZAEG1N50AC	0.04 ^{+0.04} _{-0.03}	30 V max.	-55 °C to +125 °C
EZAEG2N50AX	0.05 ^{+0.05} _{-0.04}		

*1: Capacitance = The capacitance value shall be measured under the conditions specified below.

Frequency : 1 MHz ± 10 %, Voltage : 1 Vrms ± 0.2 Vrms, Temperature : 25 °C ± 2 °C

Performance

Test item	Performance requirements	Test conditions
Peak voltage	500 V max.	IEC61000-4-2, contact discharge 8 kV, Peak voltage value
Clamping voltage	100 V max.	IEC61000-4-2, contact discharge 8 kV, voltage at 30 ns after initiation of pulse
Leakage current	1 µA max.	Current at rated voltage (DC 30 V)
ESD withstanding	Leakage current 10 µA max.	IEC61000-4-2, contact discharge 15 kV or air discharge 15 kV, +/- 50 times
Rapid change of temperature		-55 °C (30 min.) / +125 °C (30 min.), 100 cycles
Load life in humidity		60 °C, 90 % to 95 %RH, Rated voltage, 1000 h
Endurance at 85 °C		85 °C, Rated voltage, 1000 h
Resistance to soldering heat		270 °C, 10 s

Frequency characteristics

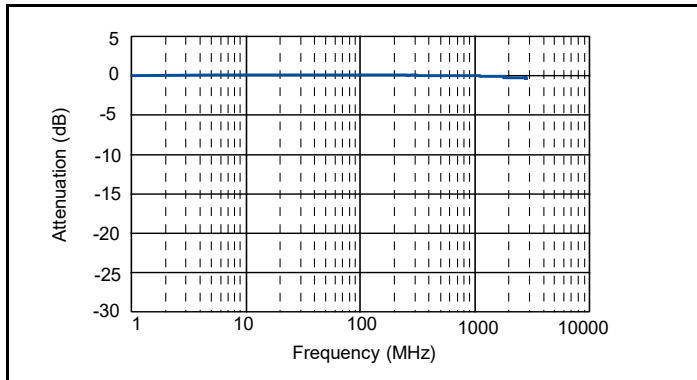

ESD Suppression voltage waveform

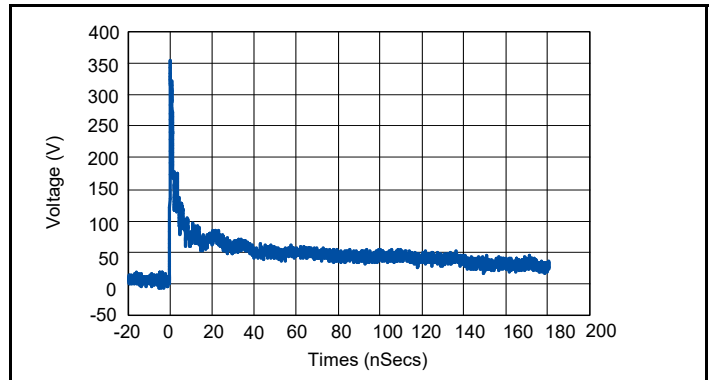

Typical circuits requiring protection

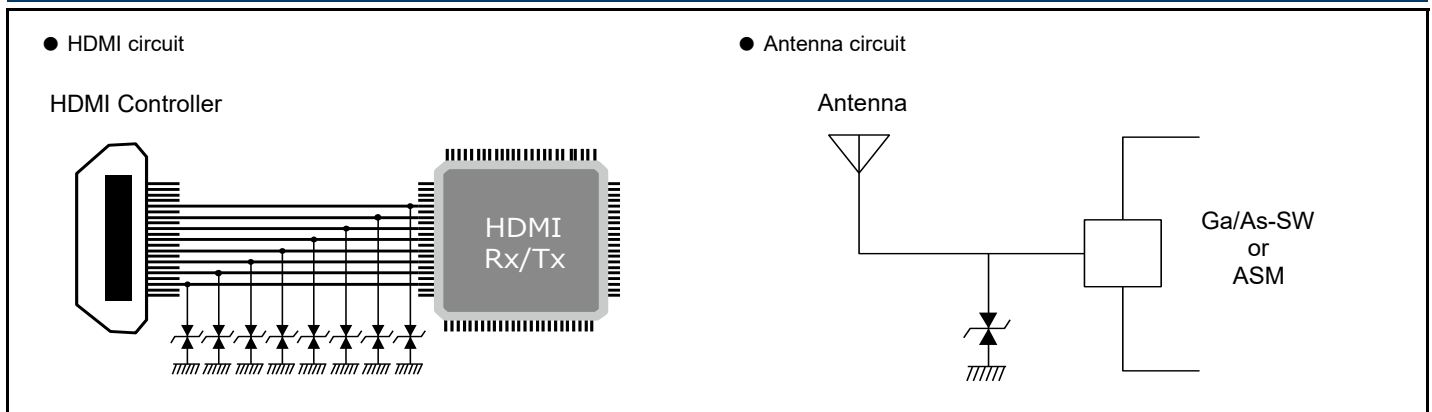

Recommended land pattern

Recommended land pattern design for ESD Suppressor is shown below.

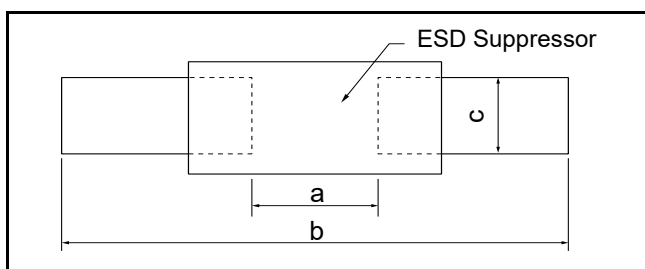

Unit : mm

Part number	Dimensions		
	a	b	c
EZAEG1N	0.3 to 0.4	0.8 to 0.9	0.25 to 0.35
EZAEG2N	0.5 to 0.6	1.4 to 1.6	0.40 to 0.60

■ As for packaging methods, soldering conditions and safety precautions, please see data files.

ESD Suppressor Array

EZAEG CA type

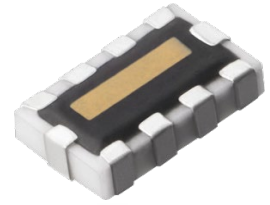

- Don't use these products in the engine room.
- Don't use these products in any driving applications or any other critical functions that may affect passenger's safety. (e.g. Power train, ABS, Engine ECU, Air bag, and so on.)
- Don't use these products in applications related to the autonomous driving equipment with system level 3 or higher.

Features

- 4 ESD suppressors in one package
- ESD protection of high-speed data lines
- Low capacitance (0.25 pF)
- Good ESD suppression characteristics
- Good ESD withstanding
- RoHS compliant

Recommended applications

- AV equipment (LCD-TV, DVD/Blu-ray drives), Information equipment (PCs, HDD)
- ESD suppression of high-speed differential data line such as USB3.0, HDMI, Display Port

Explanation of part numbers

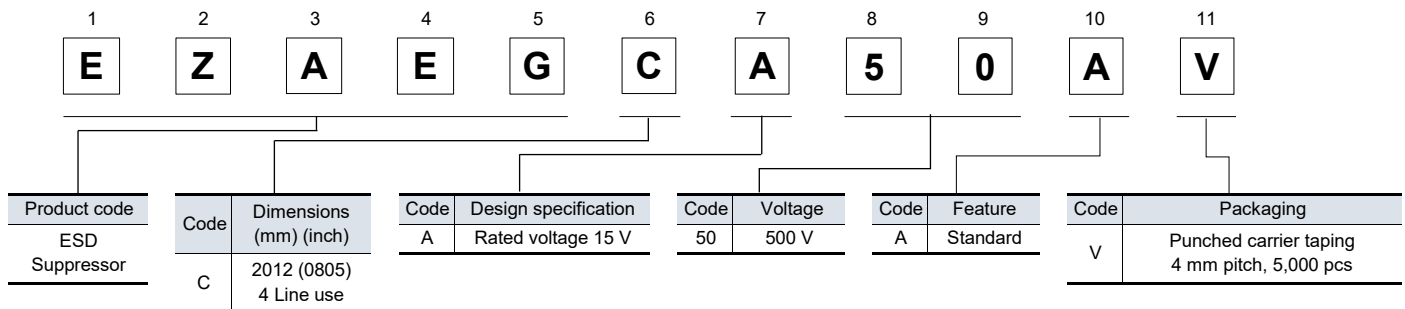

Construction

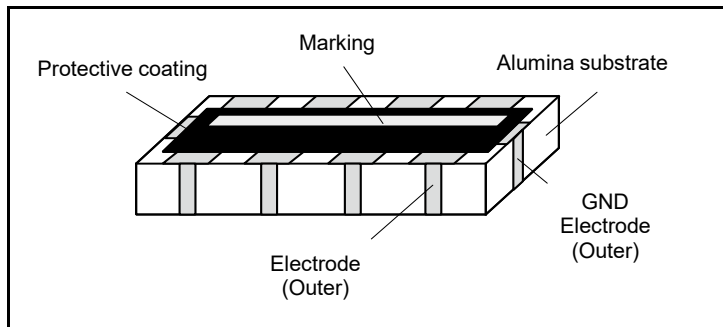

Circuit configuration

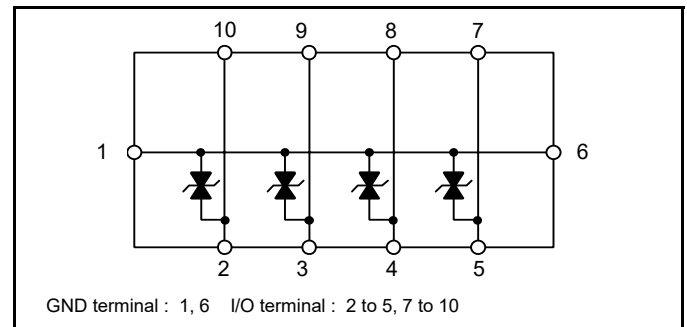

Dimensions (not to scale)

() Reference
Unit : mm

Part No. (inch size)	Dimensions								Mass (Weight) (g/1000 pcs)
	L	W	a	b	c	d	e	T	
EZAEGCA50AV (0805)	2.0 ± 0.1	1.25 ± 0.10	(0.5)	0.30 ± 0.15	0.25 ± 0.15	0.20 ± 0.15	0.35 ± 0.15	0.50 ± 0.10	4.0

Ratings

Part number	Capacitance *1 (pF)	Rated voltage *2	Rated current *3	Category temperature range
EZAEGCA50AV	0.25 ^{+0.05} / _{-0.10}	15 V max.	100 mA max.	-55 °C to +125 °C

*1: Capacitance = The capacitance value shall be measured under the conditions specified below.

Frequency : 1 MHz ± 10 %, Voltage : 1 Vrms ± 0.2 Vrms, Temperature : 25 °C ± 2 °C

*2: Rated voltage between I/O terminal and GND.

*3: Rated current between input terminal and output terminal.

Performance

Test item	Performance requirements	Test conditions
Peak voltage	500 V max.	IEC61000-4-2, contact discharge 8 kV, Peak voltage value
Clamping voltage	100 V max.	IEC61000-4-2, contact discharge 8 kV, voltage at 30 ns after initiation of pulse
Leakage current	1 µA max.	Current at Rated voltage (DC 15 V)
ESD withstanding	Leakage current 10 µA max.	IEC61000-4-2, contact discharge 8 kV, +/- 10 times
Rapid change of temperature		-55 °C (30 min.) / +125 °C (30 min.), 100 cycles
Load life in humidity		60 °C, 90 % to 95 %RH, Rated voltage, 1000 h
Endurance at 85 °C		85 °C, Rated voltage, 1000 h
Resistance to soldering heat		270 °C, 10 s

Typical circuits requiring protection

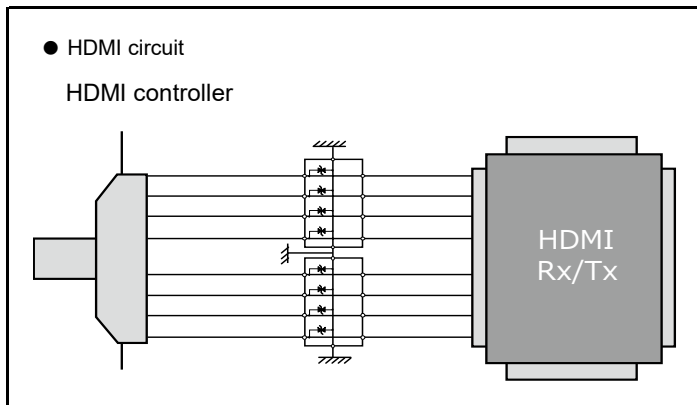

ESD Suppression voltage waveform

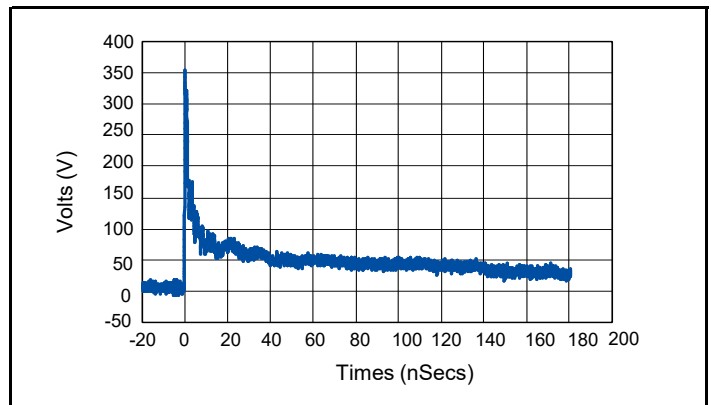

Recommended land pattern

Recommended land pattern design for ESD Suppressor Array is shown below.

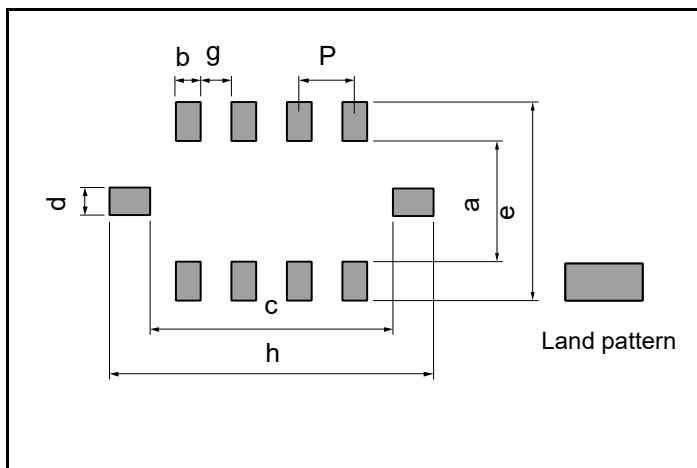

Unit : mm

Dimensions			
a	b	c	d
0.75	0.25	1.70	0.35

Dimensions			
e	h	g	P
1.85	2.60	0.25	0.50

■ As for packaging methods, soldering conditions and safety precautions, please see data files.



ESD Suppressor / High withstanding products

EZAEG 3W type

Features

- Excellent ESD withstanding(Conforms with automotive ESD standards (ISO10605, air discharge 25 kV)
- Low capacitance 1608 (0603) size : 0.10 pF
- High rated voltage (DC 50 V) contributes to reduce the risk of communication error
- AEC-Q200 compliant
- RoHS compliant

Recommended applications

- High speed data line for automotive (CAN, Ethernet, USB, LVDS)
- Automotive antenna
- Amusement equipment

Explanation of part numbers

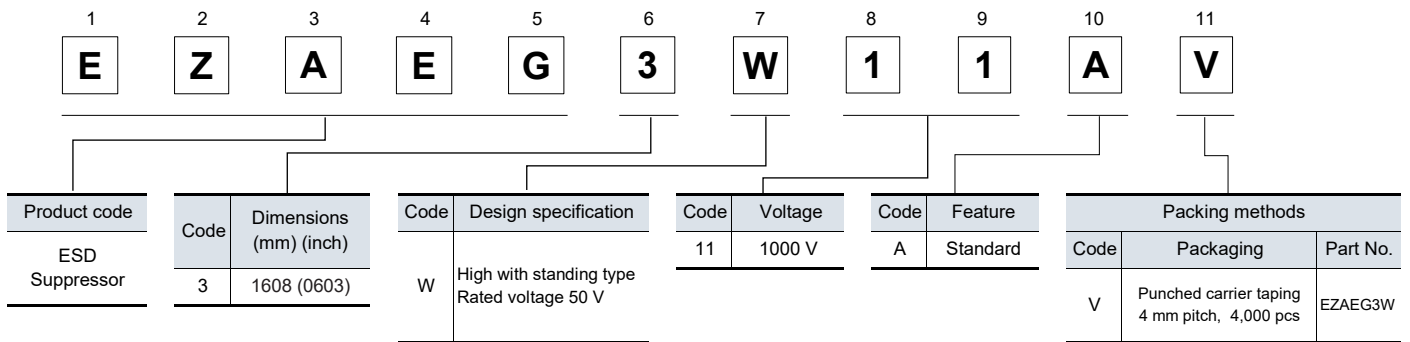

Construction

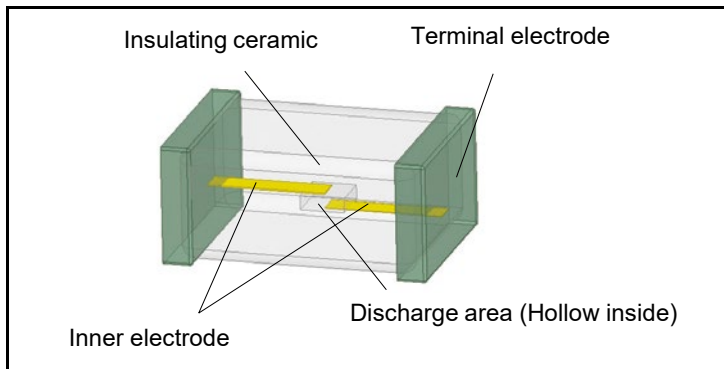

Circuit configuration

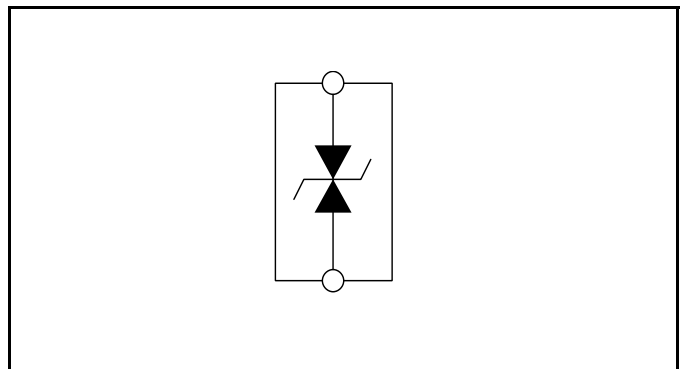

Dimensions (not to scale)

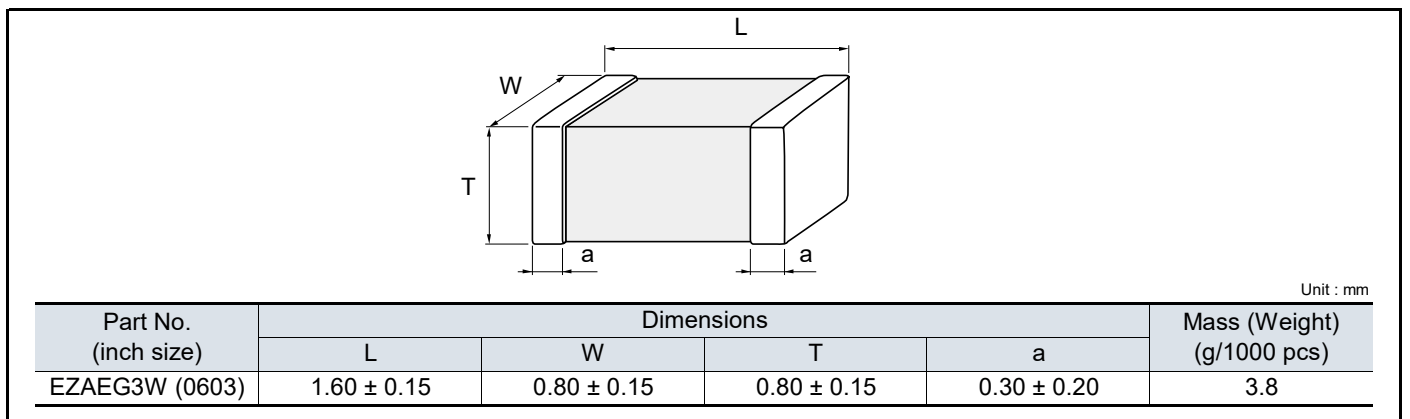

Ratings

Part number	Capacitance*1 (pF)	Rated voltage	Category temperature range
EZAEG3W11AV	0.10 $\begin{smallmatrix} +0.10 \\ -0.08 \end{smallmatrix}$	50 V max.	-55 °C to +125 °C

*1: Capacitance = The capacitance value shall be measured under the conditions specified below.

Frequency : 1 MHz \pm 10 %, Voltage : 1 Vrms \pm 0.2 Vrms, Temperature : 25 °C \pm 2 °C

Performance

Test item	Performance requirements	Test conditions
Peak voltage	1000 V max.	ISO10605, air discharge 15 kV, Peak voltage value
Leakage current	1 μ A max.	Current at Rated voltage (DC 50 V)
ESD withstanding	Leakage current 10 μ A max.	ISO10605, air discharge 25 kV, +/- 50 times
Rapid change of temperature		-55 °C (30 min.) / +125 °C (30 min.), 100 cycles
Load life in humidity		85 °C, 85 %RH, Rated voltage, 1000 h
Endurance at 125 °C		125 °C, Rated voltage, 1000 h
Resistance to soldering Heat		270 °C, 10 s

Frequency characteristics

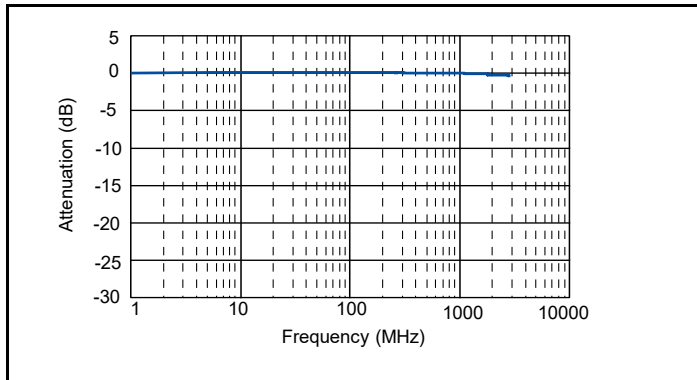

ESD Suppression voltage waveform

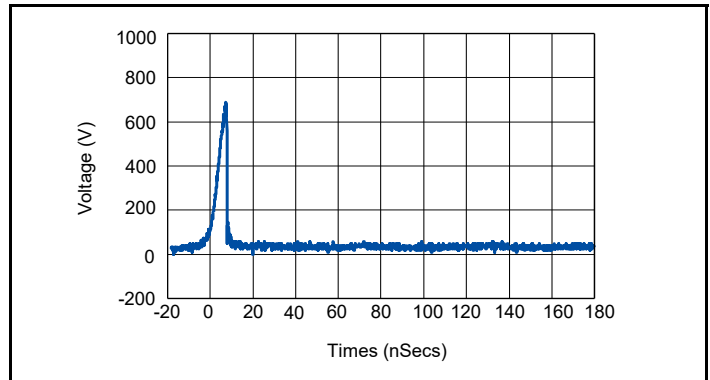

Typical circuits requiring protection

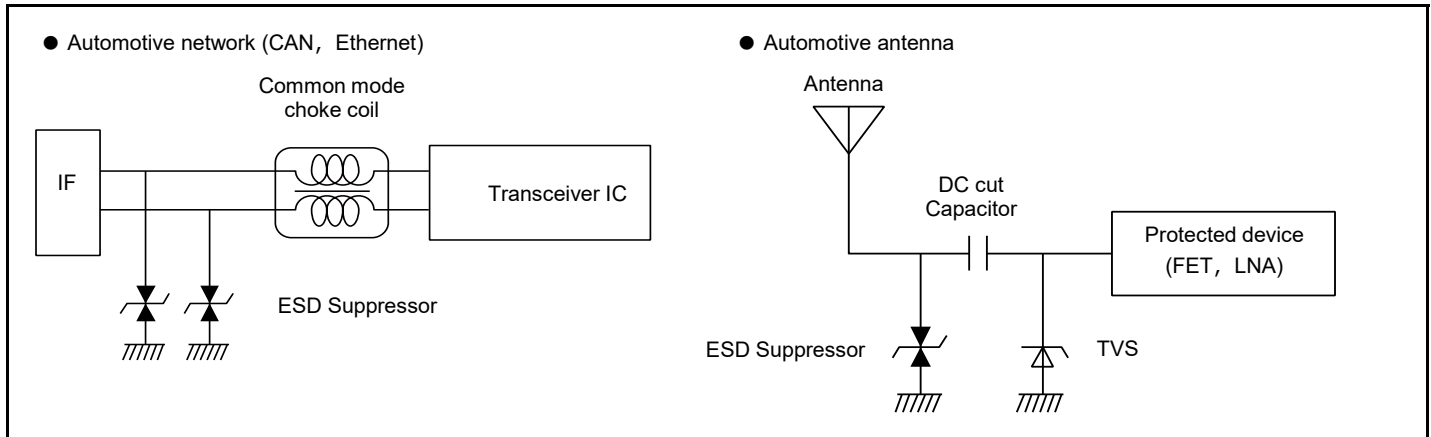

Recommended land pattern

Recommended land pattern design for ESD Suppressor is shown below.

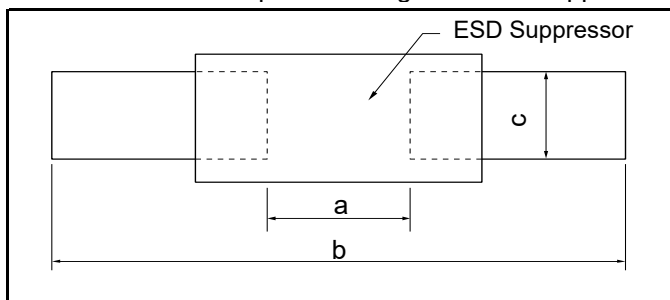

Part number	Dimensions		
	a	b	c
EZAEG3W	0.8 to 1.0	2.0 to 2.6	0.8 to 1.0

Unit : mm

■ As for packaging methods, soldering conditions and safety precautions, please see data files.

Packaging methods (Taping)

● Standard quantity

Part number	Size (inch)	Type	Kind of taping	Pitch (P ₁) (mm)	Quantity (pcs / reel)
EZAEG1N	0201	Single	Pressed carrier taping	2	15000
EZAEG2A,2N	0402				10000
EZAEG3A	0603		Array	Punched carrier taping	4
EZAEG3W	0603	4000			
EZAEGCA	0805	5000			

● Carrier taping

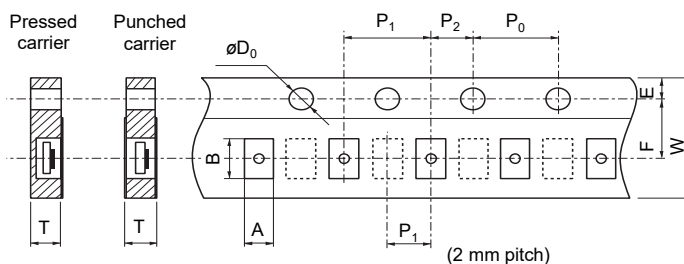

Unit : mm

Part number	Size(inch)	A	B	W	F	E	P ₁	P ₂	P ₀	ϕD_0	T
EZAEG1N	0201	0.38±0.05	0.68±0.05	8.00±0.20	3.50±0.05	1.75±0.10	2.00±0.10			1.5 ^{+0.1} ₀	0.42±0.05
EZAEG2A,2N	0402	0.70±0.05	1.20±0.05								0.60±0.05
EZAEG3A	0603	1.10±0.10	1.90±0.10				0.70±0.05				
EZAEG3W	0603	0.91±0.10	1.82±0.10				4.00±0.10	2.00±0.05	4.00±0.10		1.08±0.10
EZAEGCA	0805	1.55±0.15	2.30±0.20								0.85±0.05

● Taping reel

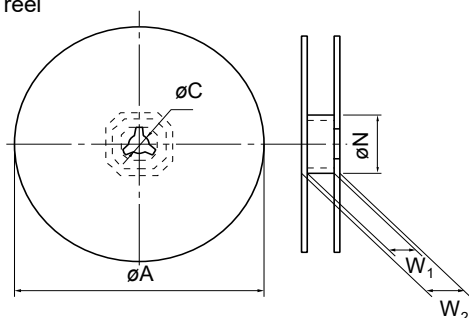

Dimensions		
ϕA	ϕN	ϕC
180.0 ⁰ _{-1.5}	60.0 ^{+1.0} ₀	13.0±0.2

Dimensions	
W ₁	W ₂
9.0 ^{+1.0} ₀	11.4±1.0

Unit : mm

Recommended soldering conditions

Recommendations and precautions are described below

● Recommended soldering conditions for reflow

- Reflow soldering shall be performed a maximum of two times.
- Please contact us for additional information when used in conditions other than those specified.
- Please measure the temperature of the terminals and study every kind of solder and printed circuit board for solderability before actual use.

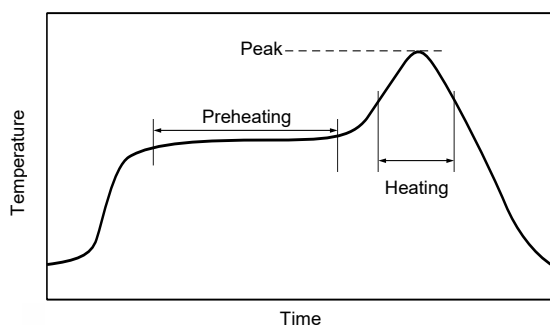

For soldering (Example : Sn/Pb)

	Temperature	Time
Preheating	140 °C to 160 °C	60 s to 120 s
Main heating	Above 200 °C	30 s to 40 s
Peak	235 ± 5 °C	max. 10 s

For lead-free soldering (Example : Sn/Ag/Cu)

	Temperature	Time
Preheating	150 °C to 180 °C	60 s to 120 s
Main heating	Above 230 °C	30 s to 40 s
Peak	max. 260 °C	max. 10 s



Application Guidelines (EZJZ-M, EZJP-M series)

1. Handling precautions

- Do not use the products beyond the descriptions in this product catalog.
- This product catalog guarantees the quality of the products as individual components. Before you use the products, please make sure to check and evaluate the products in the circumstance where they are installed in your product.

2. Safety precautions

The chip-type multi-layer varistor for automotive applications (hereinafter referred to as Varistor) is intended to be used for general-purpose standard applications as a measure against static electricity and noise in automotive equipment. When subjected to severe electrical, environmental, and/or mechanical stress beyond the specifications, as noted in the Ratings and Specified Conditions section, the Varistors' performance may be degraded, or become failure mode, such as short circuit mode and open-circuit mode.

If you use under the condition of short-circuit, heat generation of Varistors will occur by running large current due to application of voltage. There are possibilities of smoke emission, substrate burn-out, and, in the worst case, fire. In order to avoid loss of human life or other serious damage due to a malfunction of the product, a fail-safe design should be taken into consideration in the system design, and ensure sufficient safety by installing a protection circuit to shut down the circuit and secure the system so that the system is unlikely to become unsafe in the event of a single failure of the product.

We are trying to improve the quality and the reliability, but the durability differs depending on the use environment and the use conditions. On use, be sure to confirm the actual product under the actual use conditions.

- When applying the product to the following equipment, consult with our sales office in advance and exchange the product specifications according to the application.
 - When your application may have difficulty complying with the safety or handling precautions specified below.
 - High-quality and high-reliability required devices that have possibility of causing hazardous conditions, such as death or injury (regardless of directly or indirectly), due to failure or malfunction of the product.
- ① Aircraft and Aerospace Equipment (artificial satellite, rocket, etc.)
 - ② Submarine Equipment (submarine repeating equipment, etc.)
 - ③ Transportation Equipment (airplanes, trains, ship, traffic signal controllers, etc.)
 - ④ Power Generation Control Equipment
(atomic power, hydroelectric power, thermal power plant control system, etc.)
 - ⑤ Medical Equipment (life-support equipment, pacemakers, dialysis controllers, etc.)
 - ⑥ Information Processing Equipment (large scale computer systems, etc.)
 - ⑦ Electric Heating Appliances, Combustion devices (gas fan heaters, oil fan heaters, etc.)
 - ⑧ Rotary Motion Equipment
 - ⑨ Security Systems
 - ⑩ And any similar types of equipment

3. Strict observance

3-1. Confirmation of Rated Performance

The Varistors shall be operated within the specified rating/performance.

Applications exceeding the specifications may cause deteriorated performance and/or breakdown, resulting in degradation and/or smoking or ignition of products. The following are strictly observed.

- (1) The Varistors shall not be operated beyond the specified operating temperature range.
- (2) The Varistors shall not be operated in excess of the specified maximum allowable voltage.
- (3) The Varistors shall not be operated in the circuits to which surge current and ESD that exceeds the specified maximum peak current and maximum ESD.
- (4) Never use for AC power supply circuits.

3-2. The Varistors shall not be mounted near flammables.

4. Operating conditions and circuit design

4-1. Circuit design

4-1.1 Operating temperature and storage temperature

When operating a components-mounted circuit, please be sure to observe the "Operating Temperature Range", written in delivery specifications. Storage temperature of PCB after mounting Varistors, which is not operated, should be within the specified "Storage Temperature Range" in the delivery specifications. Please remember not to use the product under the condition that exceeds the specified maximum temperature.

4-1.2 Operating voltage

The Varistors shall not be operated in excess of the "Maximum allowable voltage". If the Varistors are operated beyond the specified Maximum allowable voltage, it may cause short and/or damage due to thermal run away. If the varistor is used in a circuit where high-frequency voltage or steep pulse voltage is continuously applied even within the rated voltage, check the reliability of the varistor.

4-1.3 Self-heating

The surface temperature of the Varistors shall be under the specified Maximum Operating Temperature in the Specifications including the temperature rise caused by self-heating. Increase the varistor temperature depending on the operating circuit conditions under the actual operating conditions of the equipment.

4-1.4 Environmental restrictions

The Varistors does not take the use under the following special environments into consideration. Accordingly, the use in the following special environments, and such environmental conditions may affect the performance of the product; prior to use, verify the performance, reliability, etc. thoroughly.

- ① Use in liquids such as water, oil, chemical, and organic solvent.
- ② Use under direct sunlight, in outdoor or in dusty atmospheres.
- ③ Use in places full of corrosive gases such as sea breeze, Cl₂, H₂S, NH₃, SO₂, and NOx.
- ④ Use in environment with large static electricity or strong electromagnetic waves or strong radial ray.
- ⑤ Where the product is close to a heating component, or where an inflammable such as a polyvinyl chloride wire is arranged close to the product.
- ⑥ Where this product is sealed or coated with resin etc.
- ⑦ Where solvent, water, or water-soluble detergent is used in flux cleaning after soldering.
(Pay particular attention to water-soluble flux.)
- ⑧ Use in such a place where the product is wetted due to dew condensation.
- ⑨ Use the product in a contaminated state.
Ex.) Do not handle the product such as sticking sebum directly by touching the product after mounting printed circuit board.
- ⑩ Under severe conditions of vibration or impact beyond the specified conditions found in the Specifications.

4-2. Design of printed circuit board

4-2.1 Selection of printed circuit boards

There is a possibility of performance deterioration by heat shock (temperature cycles), which causes cracks, from alumina substrate. Please confirm that the substrate you use does not deteriorate the Varistors' quality.

4-2.2 Design of land pattern

- (1) Recommended land dimensions are shown below. Use the proper amount of solder in order to prevent cracking. Using too much solder places excessive stress on the Varistors.

Recommended land dimensions(Ex.)

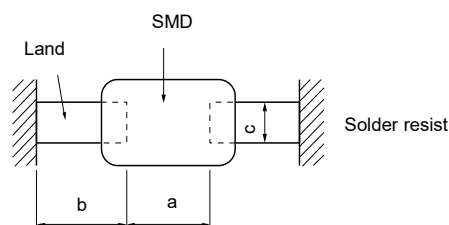

Size code / EIA	Component dimensions			a	b	c
	L	W	T			
0(0402)	1.0	0.5	0.5	0.4 to 0.5	0.4 to 0.5	0.4 to 0.5
1(0603)	1.6	0.8	0.8	0.8 to 1.0	0.6 to 0.8	0.6 to 0.8

Unit : mm

- (2) The land size shall be designed to have equal space, on both right and left side. If the amount of solder on the right land is different from that of the left land, the component may be cracked by stress since the side with a larger amount of solder solidifies later during cooling.

Recommended amount of solder

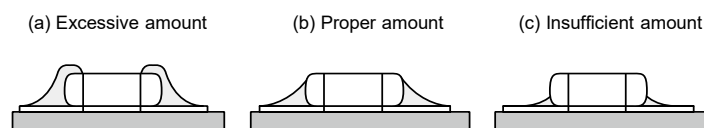

4-2.3 Utilization of solder resist

- (1) Solder resist shall be utilized to equalize the amounts of solder on both sides.
- (2) Solder resist shall be used to divide the pattern for the following cases;
 - Components are arranged closely.
 - The Varistor is mounted near a component with lead wires.
 - The Varistor is placed near a chassis.

See the table right.

Prohibited applications and recommended applications

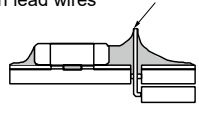
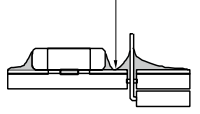
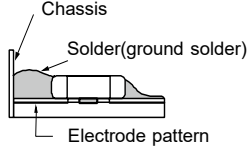
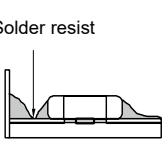
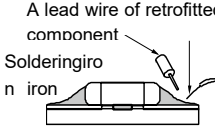
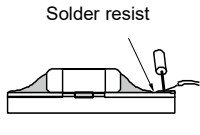
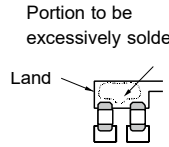
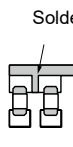
Item	Prohibited applications	Improved applications by pattern division
Mixed mounting with a component with lead wires	The lead wire of a component with lead wires 	Solder resist 
Arrangement near chassis	Chassis Solder(ground solder) Electrode pattern 	Solder resist 
Retro-fitting of component with lead wires	A lead wire of retrofitted component Soldering iron 	Solder resist 
Lateral arrangement	Portion to be excessively soldered Land 	Solder resist 

4-2.4 Component layout

To prevent the crack of Varistors, place it on the position that could not easily be affected by the bending stress of substrate while going through procedures after mounting or handling.

- (1) To minimize mechanical stress caused by the warp or bending of a PC board, please follow the recommended Varistors' layout below.

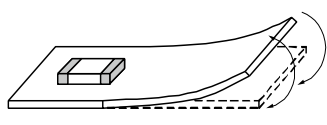
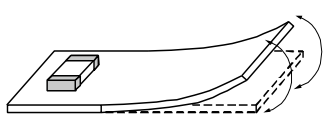
Prohibited layout	Recommended layout
	 Layout the Varistors sideways against the stressing direction.

- (2) The following layout is for your reference since mechanical stress near the dividing/breaking position of a PC board varies depending on the mounting position of the Varistors.

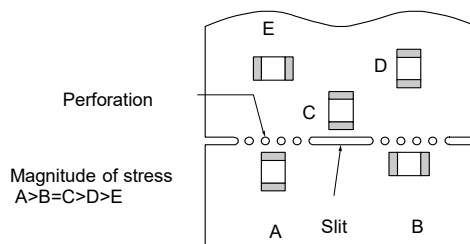

- (3) The magnitude of mechanical stress applied to the Varistors when dividing the circuit board in descending order is as follows: push back < slit < V-groove < perforation. Also take into account the layout of the Varistors and the dividing/breaking method.

4-2.5 Mounting density and spaces

If the spacing between components is too small, the effect of the solder bridge and solder ball will occur. Design the spacing so that the effect of the solder bridge and solder ball will not occur.

5. Precautions for assembly

5-1. Storage

- (1) The Varistors shall be stored between 5 to 40 °C and 20 to 70 % RH, not under severe conditions of high temperature and humidity.
- (2) If stored in a place where humidity, dust, or corrosive gasses (hydrogen sulfide, sulfurous acid, hydrogen chloride and ammonia, etc.) are contained, the solderability of terminal electrodes will be deteriorated.
Do not store tapes of taping-packaged products in the above environments as heat or direct sunlight may cause deformation of the tape or parts sticking to the tape, which may lead to problems during mounting.
- (3) Do not store components longer than 12 months. Check the solderability of products that have been stored for more than 12 months before use.

5-2. Adhesives for Mounting

- (1) The amount and viscosity of an adhesive for mounting shall be such that the adhesive will not flow off on the land during its curing.
- (2) If the amount of adhesive is insufficient for mounting, the Varistors may fall off after or during soldering.
- (3) Low-viscosity of the adhesive causes displacement of Varistors.
- (4) The heat-curing methods for adhesive are ultraviolet radiation, far-infrared radiation, and so on.
In order to prevent the terminal electrodes of the Varistors from oxidizing, the curing shall be under the following conditions: 160 °C max., for 2 minutes max.
- (5) Insufficient curing may cause the Varistors to fall off after or during soldering. In addition, insulation resistance between terminal electrodes may deteriorate due to moisture absorption. In order to prevent these problems, please observe proper curing conditions.

5-3. Chip Mounting Consideration

- (1) When mounting the Varistors components on a PC board, the Varistor bodies shall be free from excessive impact loads such as mechanical impact or stress due to the positioning, pushing force and displacement of vacuum nozzles during mounting.
- (2) Maintenance and inspection of the Chip Mounter must be performed regularly.
- (3) If the bottom dead center of the vacuum nozzle is too low, the Varistor will crack from excessive force during mounting. Please refer to the following precautions and recommendations.
 - (a) Set and adjust the bottom dead center of the vacuum nozzles to the upper surface of the PC board after correcting the warp of the PC board.
 - (b) Set the pushing force of the vacuum nozzle during mounting to 1 to 3 N in static load.
 - (c) For double surface mounting, apply a supporting pin on the rear surface of the PC board to suppress the bending of the PC board in order to minimize the impact of the vacuum nozzles. Typical examples are shown in the table below secondary.
 - (d) Adjust the vacuum nozzles so that their bottom dead center during mounting is not too low.

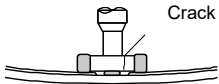
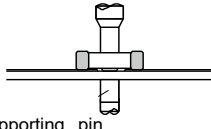
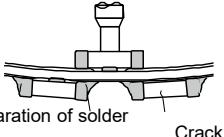
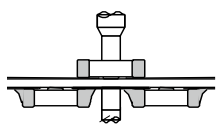
Item	Prohibited mounting	Recommended mounting
Single surface mounting	 <p>Crack</p>	 <p>Supporting pin</p> <p>The supporting pin does not necessarily have to be positioned beneath the Varistor.</p>
Double surface mounting	 <p>Separation of solder</p> <p>Crack</p>	 <p>Supporting pin</p>

- (4) The closing dimensions of the positioning chucks shall be controlled. Maintenance and replacement of positioning chucks shall be performed regularly to prevent chipping or cracking of the Varistors caused by mechanical impact during positioning due to worn positioning chucks.
- (5) Maximum stroke of the nozzle shall be adjusted so that the maximum bending of PC board does not exceed 0.5 mm at 90 mm span. The PC board shall be supported by an adequate number of supporting pins.

5-4. Selection of soldering flux

Soldering flux may seriously affect the performance of the Varistors. Please confirm enough whether the soldering flux have an influence on performance of the Varistors or not, before using.

5-5. Soldering

5-5.1 Flow soldering

When conducting flow soldering, stress from abrupt temperature change is applied to the Varistors, so the temperature, especially temperature of solder should be controlled very carefully. Varistors should not be subjected to abrupt temperature change because it causes occurrence of thermal cracks as a result of excessive thermal stress inside of the Varistors from flow soldering. You should be careful to temperature difference. If rapid heating or cooling is applied, excessive thermal stress due to a larg process follow these recommended conditions. cause thermal cracks. Therefore, observe for preheating and slow cooling as described below.

(1) Application of Soldering flux :

The soldering flux shall be applied to the mounted Varistors thinly and uniformly by foaming method.

(2) Preheating : Conduct sufficient pre-heating, and make sure that the temperature difference between solder and Varistors' surface is 150 °C or less.

(3) Immersion into Soldering bath :

The Varistors shall be immersed into a soldering bath of 240 to 260 °C for 3 to 5 seconds.

(4) Gradual Cooling : After soldering, avoid rapid cooling (forced cooling) and conduct gradual cooling, so that thermal cracks do not occur.

(5) Flux Cleaning : When the Varistors are immersed into a cleaning solvent, be sure that the surface temperatures of devices do not exceed 100 °C.

(6) Performing flow soldering once under the conditions shown in the figure below

[Recommended profile of Flow soldering (Ex.)] will not cause any problems.

However, pay attention to the possible warp and bending of the PC board.

Recommended profile of flow soldering (Ex.)

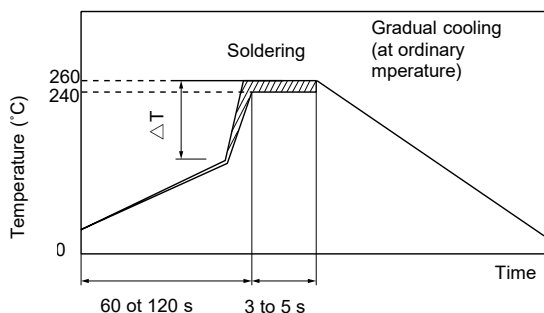

<ΔT: Allowable temperature difference>

Size / EIA	Temp. tol.
0603	T ≤ 150 °C

For products specified in individual specifications, avoid flow soldering.

5-5.2 Reflow soldering

The reflow soldering temperature conditions are composed of temperature curves of Preheating, Temp. rise, Heating, Peak and Gradual cooling. Large temperature difference inside the Varistors caused by rapid heat application to the Varistors may lead to excessive thermal stresses, contributing to the thermal cracks. The Preheating temperature requires controlling with great care so that tombstone phenomenon may be prevented.

Recommended profile of Reflow Soldering (Ex.)

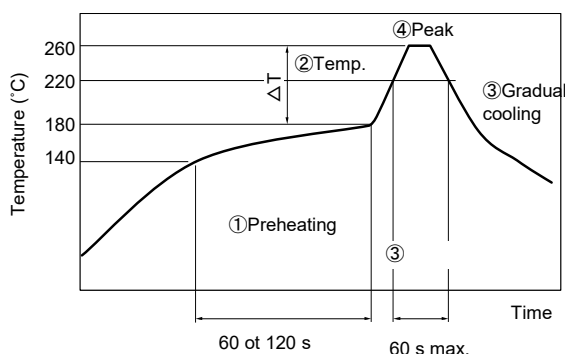

ΔT : Allowable temperature difference ΔT ≤ 150 °C

Item	Temperature	Period or speed
① Preheating	140 to 180 °C	60 to 120 s
② Temp. rise	Preheating temp to Peak temp.	2 to 5 °C / s
③ Heating	220 °C min.	60 s max.
④ Peak	260 °C max.	10 s max.
⑤ Gradual cooling	Peak temp. to 140 °C	1 to 4 °C / s

Size / EIA	Temp. tol.
0402, 0603	T ≤ 150 °C

The rapid cooling (forced cooling) during Gradual cooling part should be avoided, because this may cause defects such as the thermal cracks, etc. When the Varistors are immersed into a cleaning solvent, make sure that the surface temperatures of the devices do not exceed 100 °C. Performing reflow soldering twice under the conditions shown in the figure above [Recommended profile of Flow soldering (Ex.)] will not cause any problems.

However, pay attention to the possible warp and bending of the PC board.

Recommended soldering condition is for the guideline for ensuring the basic characteristics of the components, not for the stable soldering conditions. Conditions for proper soldering should be set up according to individual conditions. The temperature of this product at the time of mounting changes depending on mounting conditions, therefore, please confirm that Product surface becomes the specified temperature when mounting it on the end product.

5-5.3 Hand soldering

When soldering, stress is directly applied to the varistor body due to sudden temperature changes. Therefore, pay particular attention to the temperature control of the soldering iron tip. Be careful not to let the soldering iron tip directly touch the varistor body or terminal electrodes.

Varistors are particularly sensitive to rapid heating and cooling. Rapid heating and cooling can cause excessive thermal stress due to the large temperature difference inside the varistor, resulting in thermal cracks.

Therefore, observe for preheating and slow cooling as described below.

- Control the temperature of the soldering tips with special care.
- Avoid the direct contact of soldering tips with the Varistors and/or terminal electrodes.
- Do not reuse dismantled Varistors.

(1) Condition 1 (with preheating)

- (a) Soldering : Use thread solder (ø1.0 mm or below) which contains flux with low chlorine, developed for precision electronic equipment.
- (b) Preheating : Conduct sufficient preheating, and make sure that the temperature difference between solder and Varistors' surface is 150 °C or less.
- (c) Temperature of Iron tip: 350 °C max.
(The required amount of solder shall be melted in advance on the soldering tip.)
- (d) Gradual cooling : After soldering, the Varistors shall be cooled gradually at room temperature.

Recommended profile of Hand soldering (Ex.)

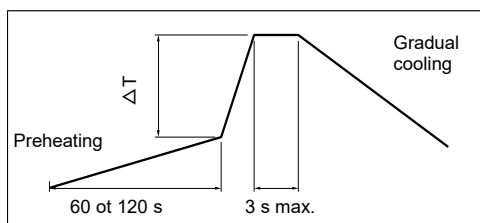

ΔT : Allowable temperature difference $\Delta T \leq 150 \text{ }^{\circ}\text{C}$

(2) Condition 2 (without preheating)

Hand soldering can be performed without preheating, by following the conditions below:

- (a) Make sure that the tip of the soldering iron does not directly touch the varistor body or terminal electrodes.
- (b) The lands are sufficiently preheated with a soldering iron tip before sliding the soldering iron tip to the terminal electrodes of the Varistors for soldering.

Conditions of hand soldering without preheating

Item	Condition
Temperature of Iron tip	350 °C max.
Wattage	20 W max.
Shape of Iron tip	ø 3 mm max.
Soldering time with a soldering iron	3 s max.

5-6. Post soldering cleaning

5-6.1 Cleaning solvent

Soldering flux residue may remain on the PC board if cleaned with an inappropriate solvent. This may deteriorate the performance of Varistors, especially insulation resistance.

5-6.2 Cleaning conditions

Inappropriate cleaning conditions such as insufficient cleaning or excessive cleaning may impair the electrical characteristics and reliability of the Varistors.

(1) Insufficient cleaning can lead to :

- (a) The halogen substance found in the residue of the soldering flux may cause the metal of terminal electrodes to corrode.
- (b) The halogen substance found in the residue of the soldering flux on the surface of the Varistors may change resistance values.
- (c) Water-soluble soldering flux may have more remarkable tendencies of (a) and (b) above compared to those of rosin soldering flux.

(2) Excessive cleaning can lead to :

- (a) When using ultrasonic cleaner, make sure that the output is not too large, so that the substrate will not resonate. The resonance causes the cracks in Varistors and/or solders, and deteriorates the strength of the terminal electrodes. Please follow these conditions for Ultrasonic cleaning:

Ultrasonic wave output : 20 W/L max.

Ultrasonic wave frequency : 40 kHz max.

Ultrasonic wave cleaning time : 5 min. max.

5-6.3 Contamination of cleaning solvent

Cleaning with contaminated cleaning solvent may cause the same results as that of insufficient cleaning due to the high density of liberated halogen.

5-7. Inspection process

The pressure from measuring terminal pins might bend the PCB when implementing circuit inspection after mounting Varistors on PCB, and as a result, cracking may occur.

- (1) Mounted PC boards shall be supported by an adequate number of supporting pins on the back with bend settings of 90 mm span 0.5 mm max.
- (2) Confirm that the measuring pins have the right tip shape, are equal in height, have the right pressure and are set in the correct positions. The following figures are for your reference to avoid bending the PC board.

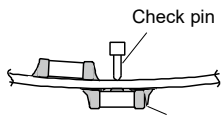
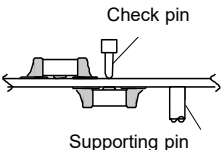
Item	Prohibited mounting	Recommended mounting
Bending of PC board	 <p>Check pin</p> <p>Separated, Crack</p>	 <p>Check pin</p> <p>Supporting pin</p>

5-8. Protective coating

Make sure characteristics and reliability when using the resin coating or resin embedding for the purpose of improvement of humidity resistance or gas resistance, or fixing of parts because failures of a thermistors such as 1), 2) and 3) may be occurred.

- (1) The solvent which contained in the resin permeate into the Varistors, and it may deteriorate the characteristic.
- (2) When hardening the resin, chemical reaction heat (curing heat generation) happen and it may occurs the infection to the Varistors.
- (3) The lead wire might be cut down and the soldering crack might be happen by expansion or contraction of resin hardening.

5-9. Dividing / Breaking of PC boards

- (1) Please be careful not to stress the substrate with bending/twisting when dividing, after mounting components including Varistors. Abnormal and excessive mechanical stress such as bending or torsion shown below can cause cracking in the Varistors.

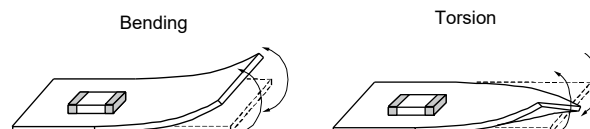

- (2) Dividing/Breaking of the PC boards shall be done carefully at moderate speed by using a jig or apparatus to prevent the Varistors on the boards from mechanical damage.

- (3) Examples of PCB dividing/breaking jigs: The outline of PC board breaking jig is shown below. When PC board are broken or divided, loading points should be close to the jig to minimize the extent of the bending. Also, planes with no parts mounted on should be used as plane of loading, in order to prevent tensile stress induced by the bending, which may cause cracks of the Varistors or other parts mounted on the PC boards.

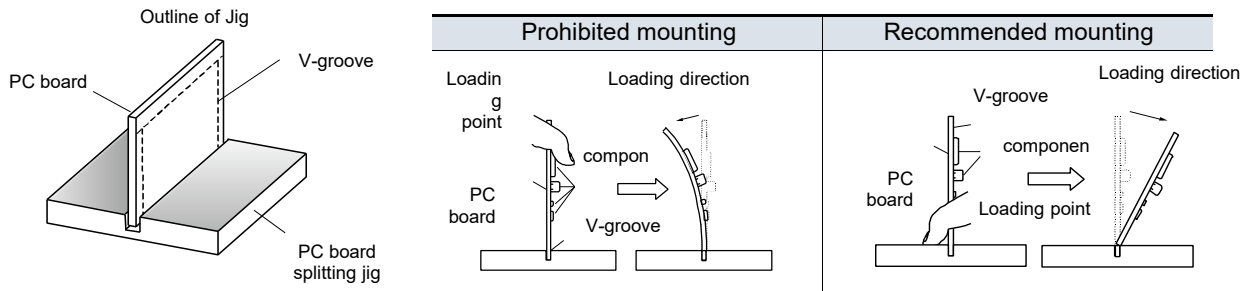

5-10. Mechanical Impact

- (1) The Varistors shall be free from any excessive mechanical impact. The Varistor body is made of ceramics and may be damaged or cracked if dropped. Never use a Varistor which has been dropped; their quality may already be impaired, and in that case, failure rate will increase.
- (2) When handling PC boards with Varistors mounted on them, do not allow the Varistors to collide with another PC board. When mounted PC boards are handled or stored in a stacked state, the corner of a PC board might strike Varistors, and the impact of the strike may cause damage or cracking and can deteriorate the withstand voltage and insulation resistance of the Varistor.

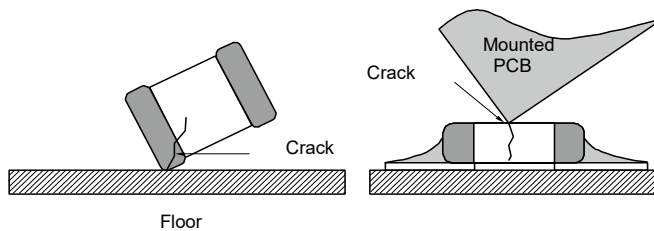

5-11. Do not reuse this product after removal from the mounting board.

6. Precautions for discarding

As to the disposal of the Varistors, check the method of disposal in each country or region where the modules are incorporated in your products to be used.

7. Other

The various precautions described above are typical. For special mounting conditions, please contact us.

8. Applicable laws and regulations , others

1. This product not been manufactured with any ozone depleting chemical controlled under the Montreal Protocol.
2. This product comply with RoHS(Restriction of the use of certain Hazardous Substance in electrical and electronic equipment) (DIRECTIVE 2011/65/EU and 2015/863/EU).
3. All the materials used in this part are registered material under the Law Concerning the Examination and Regulation of Manufacture, etc. of Chemical Substance.
4. If you need the notice by letter of "A preliminary judgement on the Laws of Japan foreign exchange and Foreign Trade Control", be sure to let us know.
5. These products are not dangerous goods on the transportation as identified by UN (United nations) numbers or UN classification.
6. The technical information in this catalog provides example of our products' typical operations and application circuit. We do not guarantee the non-infringement of third party's intellectual property rights and we do not grant any license, Right or interest in our intellectual property.

9. AEC-Q200 compliant

The products are tested based on all or part of the test conditions and methods defined in AEC-Q200. Please consult with Panasonic for the details of the product specification and specific evaluation test results, etc., make sure to exchange product specifications for each product when placing an order.

Multilayer Varistor

Automotive grade

EZJZ-M, EZJP-M series

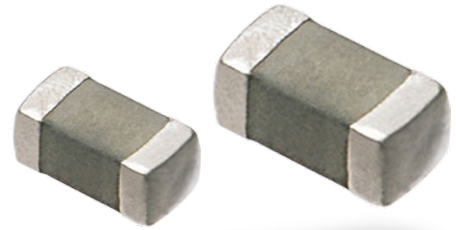

Features

- Excellent ESD suppression due to original advanced material technology
- Having large electrostatic resistance meeting IEC61000-4-2, ISO10605
- Having no polarity (bipolar) facilitated replacing Zener Diodes. Capable of replacing 2 Zener Diodes and 1 Capacitor
- Lead-free plating terminal electrodes enabling great solderability
- Wide range of products is available by adopting multilayer structure, meeting various needs
- AEC-Q200 compliant
- RoHS compliant

Explanation of part numbers

1	2	3	4	5	6	7	8	9	10	11	
E	Z	J	P	0	V	2	7	0	E	M	Example
Product code									Automotive grade		

Code	Series	Code	Dimensions (mm) (inch)	Code	Packaging style	Nominal varistor voltage			
Z	EZJZ			V	0402, 0603 Paper taping	The first and second digits denote the first 2 numbers of the varistor voltage and the third digit indicates the number of zeros following. The decimal point denotes in R.			
P	EZJP	0	1005 (0402)						
		1	1608 (0603)			Code	Capacitance	Code	Capacitance
						B	10 pF	F	68 pF
						R	20 pF	G	100 pF
						D	27 pF	H	150 pF
						E	47 pF	J	220 pF
						W	56 pF	K	330 pF

Construction

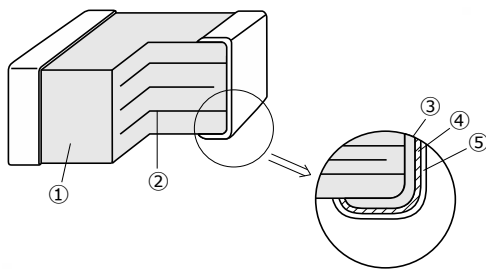

No.	Name	
①	Zinc oxide-based ceramics	
②	Internal electrode	
③	Terminal electrode	Substrate electrode
④		Intermediate electrode
⑤		External electrode

Dimensions in mm (not to scale)

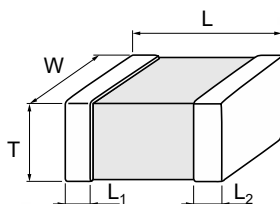

Size code	Size(inch)	L	W	T	L ₁ , L ₂
0	0402	1.00 ± 0.05	0.50 ± 0.05	0.50 ± 0.05	0.2 ± 0.1
1	0603	1.6 ± 0.1	0.8 ± 0.1	0.8 ± 0.1	0.3 ± 0.2

Unit : mm

Multilayer Varistor (Automotive grade) / EZJZ-M, EZJP-M series

Features

Wide variety of products is available by adopting multilayer construction, which achieved wide range of usage, such as application to DC voltage lines and signal lines.

- Varistor voltage : 12 to 100 V (at 1 mA)
- Capacitance : 10 to 220 pF max. (at 1 MHz)

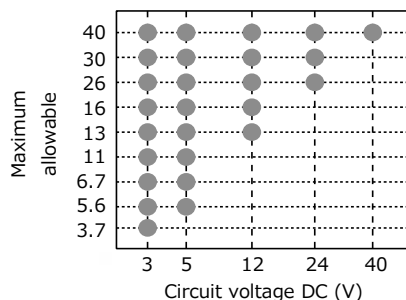

Recommended applications

- Engine ECU
- Various body ECU
- Communication line, such as CAN, LIN
- Audio, Navigation
- LED Light
- Control SW

Ratings and characteristics

Size (inch)	Part No.	Maximum allowable voltage DC (V)	Nominal varistor voltage at 1 mA (V)	Capacitance (pF)		Maximum peak current at 8/20 μ s, 2 times (A)	Maximum ESD	
				at 1 MHz	at 1 kHz		IEC61000-4-2 150 pF/ 330 Ω	ISO10605 330 pF/ 2 k Ω
0402	EZJP0V120JM	7.5	12	220 max. [150 typ.]	175 typ.	10	Contact discharge 8 kV	Contact discharge 25 kV
	EZJP0V180HM	11	18	150 max. [120 typ.]	140 typ.	10		
	EZJP0V220HM	13	22	150 max. [100 typ.]	116 typ.	10		
	EZJP0V270GM	18	27	100 max. [85 typ.]	100 typ.	10		
	EZJP0V270EM	18	27	47 max. [33 typ.]	37 typ.	4		
	EZJP0V270RM	18	27	20 max. [15 typ.]	16.5 typ.	2		
	EZJP0V270BM	18	27	10 max. [8 typ.]	10 typ.	—		
	EZJP0V330GM	25	33	100 max. [85 typ.]	100 typ.	10		
	EZJP0V420WM	30	42	56 max. [40 typ.]	45 typ.	6		
	EZJP0V650DM	40	65	27 max. [22 typ.]	33 typ.	2		
EZJP0V101BM	30	100	10 max. [8 typ.]	10 typ.	—			
0603	EZJP1V120KM	7.5	12	330 max. [250 typ.]	290 typ.	20		
	EZJP1V180JM	11	18	220 max. [180 typ.]	210 typ.	20		
	EZJP1V220JM	13	22	220 max. [160 typ.]	185 typ.	10		
	EZJP1V270GM	18	27	100 max. [85 typ.]	100 typ.	10		
	EZJP1V270EM	18	27	47 max. [33 typ.]	37 typ.	5		
	EZJP1V270RM	18	27	20 max. [15 typ.]	16.5 typ.	2		
	EZJP1V330GM	25	33	100 max. [85 typ.]	100 typ.	10		
	EZJP1V420FM	30	42	68 max. [55 typ.]	63 typ.	8		
	EZJP1V650DM	40	65	27 max. [22 typ.]	33 typ.	2		
	EZJZ1V180JM	11	18	220 max. [180 typ.]	210 typ.	20		
	EZJZ1V220JM	13	22	220 max. [160 typ.]	185 typ.	20		
	EZJZ1V270GM	16	27	100 max. [85 typ.]	100 typ.	20		
	EZJZ1V330GM	26	33	100 max. [85 typ.]	100 typ.	20		
	EZJZ1V420FM	30	42	68 max. [55 typ.]	63 typ.	15		
EZJZ1V650DM	40	65	27 max. [22 typ.]	33 typ.	5			

- Operating temperature range : EZJP serie -55 to 150 $^{\circ}$ C, EZJZ serie -55 to 125 $^{\circ}$ C

* Recommend soldering method : Reflow soldering

Maximum allowable voltage	Maximum DC Voltage that can be applied continuously within the operating temperature range
Varistor voltage	Varistor starting voltage between terminals at DC 1 mA, also known as Breakdown voltage
Maximum peak current	Maximum current that can be withstood under the standard pulse 8/20 μ s, 2 times based
Maximum ESD	Maximum voltage that can be withstood under ESD

Multilayer Varistors (Automotive grade) EZJZ-M, EZJP-M series / Characteristics

Varistor characteristics and equivalent circuit

A Multilayer Varistor does not have an electrical polarity like zener diodes and is equivalent to total 3 pcs of 2 zener diodes and 1 capacitor.

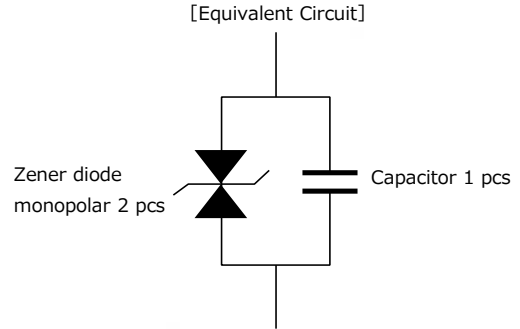
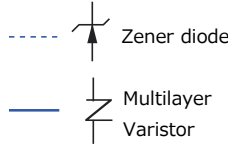
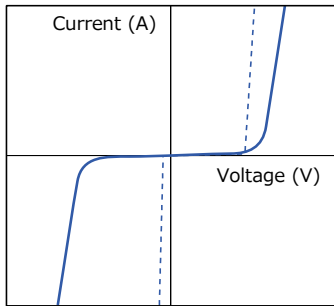

ESD Suppressive effects

Typical effects of ESD suppression

Test conditions :

IEC61000-4-2* Level 4 Contact discharge, 8 kV

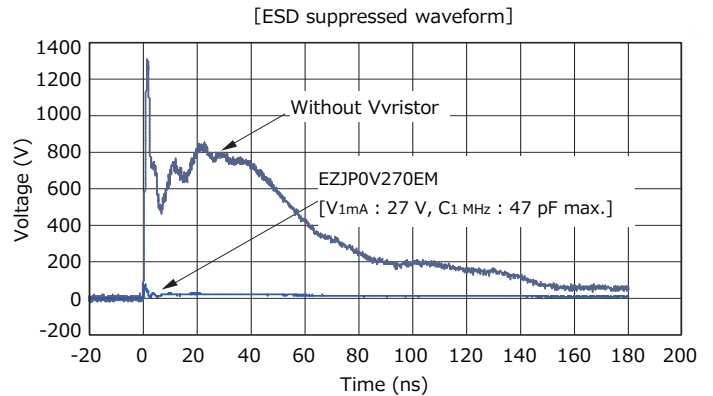
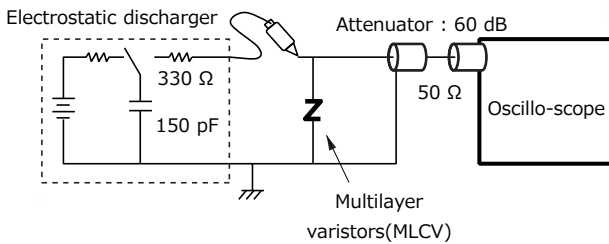

*IEC61000-4-2 ... International Standard of the ESD testing method (HBM) for electronic equipment ability to withstand ESD generated from a human body. It sets 4 levels of severity

Severity	Level 1	Level 2	Level 3	Level 4
Contact discharge	2 kV	4 kV	6 kV	8 kV
Air discharge	2 kV	4 kV	8 kV	15 kV

Replacement of zener diode

Replacing "Zener diode and Capacitor" with Multilayer Varistor saves both the mounting area and number of components used.

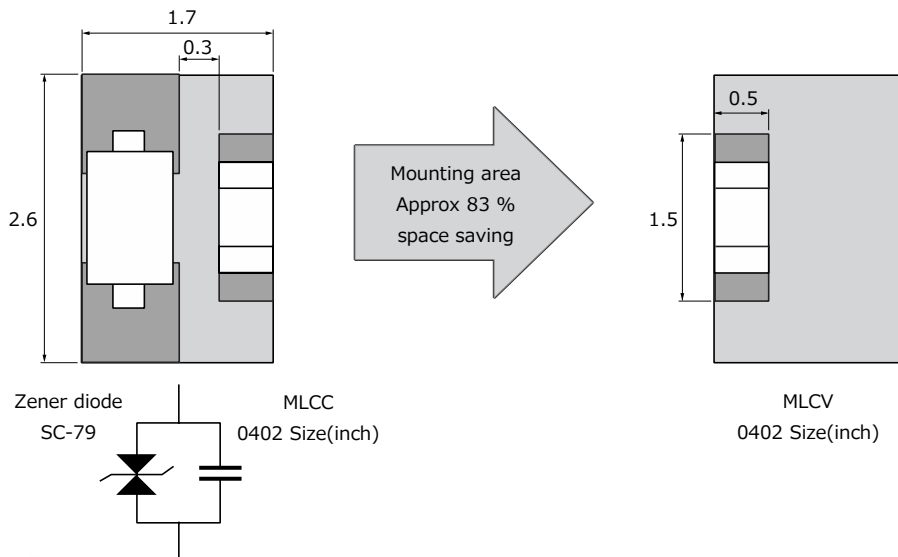

Unit : mm

Multilayer Varistors (Automotive grade) EZJZ-M, EZJP-M series / Performance and testing

Performance and testing methods

Characteristics	Specifications	Testing method															
Standard test conditions		Electrical characteristics shall be measured under the following conditions. Temp. : 5 to 35 °C, Relative humidity : 85 % or less															
Varistor voltage	To meet the specified value.	The Varistor voltage is the voltage (V_C , or V_{cmA}) between both end terminals of a Varistor when specified current (CmA) is applied to it. The measurement shall be made as quickly as possible to avoid heating effects.															
Maximum allowable voltage	To meet the specified value.	The maximum DC voltage that can be applied continuously to a varistor.															
Capacitance	To meet the specified value.	Capacitance shall be measured at the specified frequency, bias voltage 0 V, and measuring voltage 0.2 to 2.0 Vrms															
Maximum peak current	To meet the specified value.	The maximum current measured (Varistor voltage tolerance is within ± 10 %) when a standard impulse current of 8/20 μ seconds is applied twice with an interval of 5 minutes.															
Maximum ESD	To meet the specified value.	The maximum ESD measured (while the varistor voltage is within blow ranges of its nominal value) when exposed to ESD 10 times (five times for each positive-negative polarity) based on IEC61000-4-2, ISO10605. EZJP□□□□□□M : within ± 10 %, EZJZ□□□□□□M : within ± 30 %															
Solder ability	To meet the specified value.	The part shall be immersed into a soldering bath under the conditions below. Solder : Sn-Ag-Cu Soldering flux : Ethanol solution of rosin (Concentration approx. 25 wt%) Soldering temp. : 230 \pm 5 °C Period : 4 \pm 1 s Soldering position : Immerse both terminal electrodes until they are completely into the soldering bath.															
Resistance to soldering heat	$\Delta V_C/V_C$: within ± 10 %	After the immersion, leave the part for 24 \pm 2 hours under the standard condition, then evaluate its characteristics. Soldering conditions are specified below: Soldering conditions : 270 °C , 3 s / 260 °C , 10 s Soldering position : Immerse both terminal electrodes until they are completely into the soldering bath.															
Temperature cycling	$\Delta V_C/V_C$: within ± 10 %	After repeating the cycles stated below for specified number of times, leave the part for 24 \pm 2 hours, then evaluate its characteristics. Cycle : 2000 cycles <table border="1" style="margin-left: auto; margin-right: auto;"> <thead> <tr> <th>Step</th> <th>Temperature</th> <th>Period</th> </tr> </thead> <tbody> <tr> <td>1</td> <td>Max. operating temp.</td> <td>30\pm3 min</td> </tr> <tr> <td>2</td> <td>Ordinary temp.</td> <td>3 min max.</td> </tr> <tr> <td>3</td> <td>Min. operating temp.</td> <td>30\pm3 min</td> </tr> <tr> <td>4</td> <td>Ordinary temp.</td> <td>3 min max.</td> </tr> </tbody> </table>	Step	Temperature	Period	1	Max. operating temp.	30 \pm 3 min	2	Ordinary temp.	3 min max.	3	Min. operating temp.	30 \pm 3 min	4	Ordinary temp.	3 min max.
Step	Temperature	Period															
1	Max. operating temp.	30 \pm 3 min															
2	Ordinary temp.	3 min max.															
3	Min. operating temp.	30 \pm 3 min															
4	Ordinary temp.	3 min max.															
Vibration	$\Delta V_C/V_C$: within ± 10 %	The varistor shall be soldered on the testing board shown. G force : 5 G Vibration frequency range : 10 to 2000 Hz Sweet time : 20 min. Sweet direction : 12 cycles for 3 courses perpendicular each other															
Mechanical shock	$\Delta V_C/V_C$: within ± 10 %	The varistor shall be soldered on the testing board shown. Shock-wave formation : Half sine , 11 ms G force : 50 G Sweet direction : 6 directions of X, Y, Z, for each three times															
Biased humidity	$\Delta V_C/V_C$: within ± 10 %	After conducting the test under the conditions specified below, leave the part 24 \pm 2 hours, then evaluate its characteristics. Temp. : 85 \pm 2 °C Humidity : 80 to 85 %RH Applied voltage : Maximum allowable voltage (Individually specified) Period : 2000+24/0 h															
High temperature exposure (dry heat)	$\Delta V_C/V_C$: within ± 10 %	After conducting the test under the conditions specified below, leave the part 24 \pm 2 hours, then evaluate its characteristics. Temp. : Maximum operating temperature ± 3 °C (Individually specified) Applied voltage : Maximum allowable voltage (Individually specified) Period : 2000+24/0 h															

Multilayer Varistors (Automotive grade) EZJZ-M, EZJP-M series / Packaging

Packaging methods (Taping)

● Standard quantity

Series	Size code (inch size)	Thickness (mm)	Kind of taping	Pitch (mm)	Quantity (pcs/reel)
EZJZ, EZJP	0 (0402)	0.5	Punched carrier taping	2	10,000
	1 (0603)	0.8		4	4,000

● 2 mm Pitch (Punched carrier taping) Size 0402

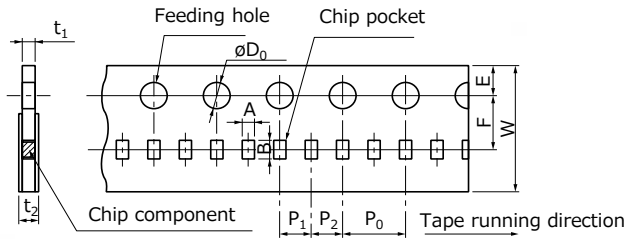

● 4 mm Pitch (Punched carrier taping) Size 0603

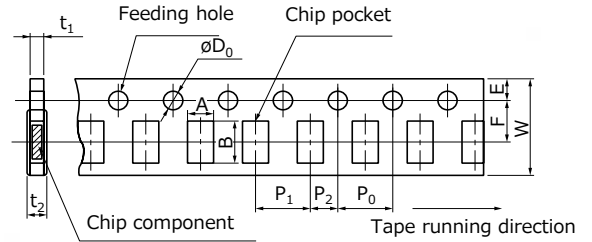

Unit : mm

Code	A	B	W	F	E	P ₁	P ₂	P ₀	φD ₀	t ₁	t ₂
EZJZ	0.62	1.12	8.0	3.50	1.75	2.00	2.00	4.0	1.5	0.7	1.0
EZJP	±0.05	±0.05	±0.2	±0.05	±0.10	±0.05	±0.05	±0.1	+0.1 0	max.	max.

Unit : mm

Code	A	B	W	F	E	P ₁	P ₂	P ₀	φD ₀	t ₁	t ₂
EZJZ	1.0	1.8	8.0	3.50	1.75	4.0	2.00	4.0	1.5	1.1	1.4
EZJP	±0.1	±0.1	±0.2	±0.05	±0.10	±0.1	±0.05	±0.1	+0.1 0	max.	max.

● Reel for taping

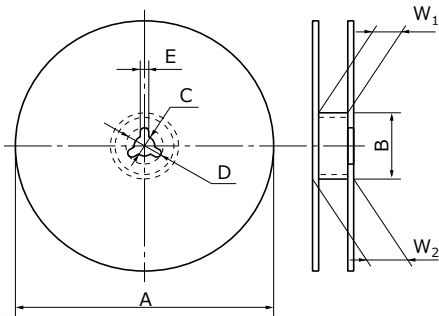

Unit : mm

Code	A	B	C	D	E	W ₁	W ₂
EZJZ	ø180	ø60.0	13.0	21.0	2.0	9.0	11.4
EZJP	⁰ / ₋₃	^{+1.0} / ₀	±0.5	±0.8	±0.5	^{+1.0} / ₀	±1.0

● Leader part and taped end

Leader part

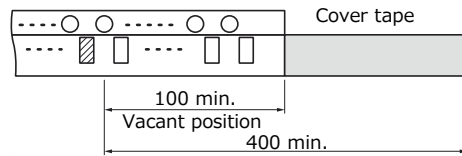

Tape end

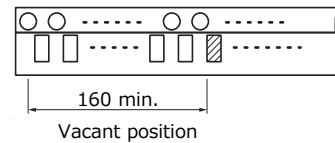

Unit : mm

■ As for packaging methods, handling precautions please see data files



Application Guidelines

(EZJZ, EZJP series : For DC voltage lines, high speed signal lines /
EZJS series : For DC voltage lines)

1. Handling precautions

- Do not use the products beyond the descriptions in this product catalog.
- This product catalog guarantees the quality of the products as individual components. Before you use the products, please make sure to check and evaluate the products in the circumstance where they are installed in your product.

2. Safety precautions

The chip-type multi-layer varistor for automotive applications (hereinafter referred to as Varistor) is intended to be used for general-purpose standard applications as a measure against static electricity and noise in automotive equipment. When subjected to severe electrical, environmental, and/or mechanical stress beyond the specifications, as noted in the Ratings and Specified Conditions section, the Varistors' performance may be degraded, or become failure mode, such as short circuit mode and open-circuit mode. If you use under the condition of short-circuit, heat generation of Varistors will occur by running large current due to application of voltage. There are possibilities of smoke emission, substrate burn-out, and, in the worst case, fire. In order to avoid loss of human life or other serious damage due to a malfunction of the product, a fail-safe design should be taken into consideration in the system design, and ensure sufficient safety by installing a protection circuit to shut down the circuit and secure the system so that the system is unlikely to become unsafe in the event of a single failure of the product.

We are trying to improve the quality and the reliability, but the durability differs depending on the use environment and the use conditions. On use, be sure to confirm the actual product under the actual use conditions.

- When applying the product to the following equipment, consult with our sales office in advance and exchange the product specifications according to the application.
 - When your application may have difficulty complying with the safety or handling precautions specified below.
 - High-quality and high-reliability required devices that have possibility of causing hazardous conditions, such as death or injury (regardless of directly or indirectly), due to failure or malfunction of the product.
 - ① Aircraft and Aerospace Equipment (artificial satellite, rocket, etc.)
 - ② Submarine Equipment (submarine repeating equipment, etc.)
 - ③ Transportation Equipment (airplanes, trains, ship, traffic signal controllers, etc.)
 - ④ Power Generation Control Equipment
(atomic power, hydroelectric power, thermal power plant control system, etc.)
 - ⑤ Medical Equipment (life-support equipment, pacemakers, dialysis controllers, etc.)
 - ⑥ Information Processing Equipment (large scale computer systems, etc.)
 - ⑦ Electric Heating Appliances, Combustion devices (gas fan heaters, oil fan heaters, etc.)
 - ⑧ Rotary Motion Equipment
 - ⑨ Security Systems
 - ⑩ And any similar types of equipment

3. Strict observance

3-1. Confirmation of Rated Performance

The Varistors shall be operated within the specified rating/performance.

Applications exceeding the specifications may cause deteriorated performance and/or breakdown, resulting in degradation and/or smoking or ignition of products. The following are strictly observed.

- (1) The Varistors shall not be operated beyond the specified operating temperature range.
- (2) The Varistors shall not be operated in excess of the specified maximum allowable voltage.
- (3) The Varistors shall not be operated in the circuits to which surge current and ESD that exceeds the specified maximum peak current and maximum ESD.
- (4) Never use for AC power supply circuits.

3-2. The Varistors shall not be mounted near flammables.

4. Operating conditions and circuit design

4-1. Circuit design

4-1.1 Operating temperature and storage temperature

When operating a components-mounted circuit, please be sure to observe the "Operating Temperature Range", written in delivery specifications. Storage temperature of PCB after mounting Varistors, which is not operated, should be within the specified "Storage Temperature Range" in the delivery specifications. Please remember not to use the product under the condition that exceeds the specified maximum temperature.

4-1.2 Operating voltage

The Varistors shall not be operated in excess of the "Maximum allowable voltage". If the Varistors are operated beyond the specified Maximum allowable voltage, it may cause short and/or damage due to thermal run away. If the varistor is used in a circuit where high-frequency voltage or steep pulse voltage is continuously applied even within the rated voltage, check the reliability of the varistor.

4-1.3 Self-heating

The surface temperature of the Varistors shall be under the specified Maximum Operating Temperature in the Specifications including the temperature rise caused by self-heating. Increase the varistor temperature depending on the operating circuit conditions under the actual operating conditions of the equipment.

4-1.4 Environmental restrictions

The Varistors does not take the use under the following special environments into consideration. Accordingly, the use in the following special environments, and such environmental conditions may affect the performance of the product; prior to use, verify the performance, reliability, etc. thoroughly.

- ① Use in liquids such as water, oil, chemical, and organic solvent.
- ② Use under direct sunlight, in outdoor or in dusty atmospheres.
- ③ Use in places full of corrosive gases such as sea breeze, Cl₂, H₂S, NH₃, SO₂, and NOx.
- ④ Use in environment with large static electricity or strong electromagnetic waves or strong radial ray.
- ⑤ Where the product is close to a heating component, or where an inflammable such as a polyvinyl chloride wire is arranged close to the product.
- ⑥ Where this product is sealed or coated with resin etc.
- ⑦ Where solvent, water, or water-soluble detergent is used in flux cleaning after soldering.
(Pay particular attention to water-soluble flux.)
- ⑧ Use in such a place where the product is wetted due to dew condensation.
- ⑨ Use the product in a contaminated state.
Ex.) Do not handle the product such as sticking sebum directly by touching the product after mounting printed circuit board.
- ⑩ Under severe conditions of vibration or impact beyond the specified conditions found in the Specifications.

4-2. Design of printed circuit board

4-2.1 Selection of printed circuit boards

There is a possibility of performance deterioration by heat shock (temperature cycles), which causes cracks, from alumina substrate. Please confirm that the substrate you use does not deteriorate the Varistors' quality.

4-2.2 Design of land pattern

- (1) Recommended land dimensions are shown below. Use the proper amount of solder in order to prevent cracking. Using too much solder places excessive stress on the Varistors.

Recommended land dimensions(Ex.)

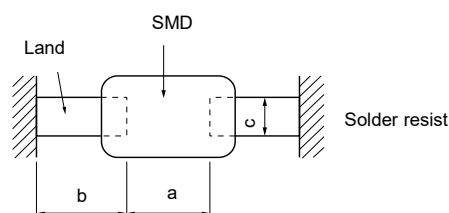

Unit : mm

Size code / EIA	Component dimensions			a	b	c
	L	W	T			
Z(0201)	0.6	0.3	0.3	0.2 to 0.3	0.25 to 0.30	0.2 to 0.3
0(0402)	1.0	0.5	0.5	0.4 to 0.5	0.4 to 0.5	0.4 to 0.5
1(0603)	1.6	0.8	0.8	0.8 to 1.0	0.6 to 0.8	0.6 to 0.8
2(0805)	2.0	1.25	0.8 to 1.25	0.8 to 1.2	0.8 to 1.0	0.8 to 1.0

- (2) The land size shall be designed to have equal space, on both right and left side. If the amount of solder on the right land is different from that of the left land, the component may be cracked by stress since the side with a larger amount of solder solidifies later during cooling.

Recommended amount of solder

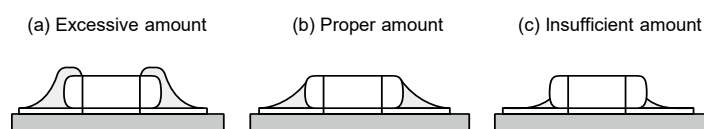

4-2.3 Utilization of solder resist

- (1) Solder resist shall be utilized to equalize the amounts of solder on both sides.
- (2) Solder resist shall be used to divide the pattern for the following cases;
 - Components are arranged closely.
 - The Varistor is mounted near a component with lead wires.
 - The Varistor is placed near a chassis.

See the table right.

Prohibited applications and recommended applications

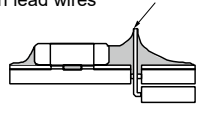
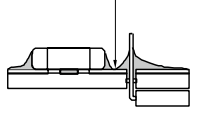
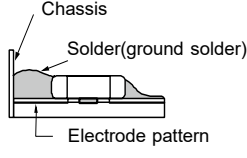
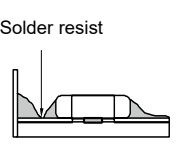
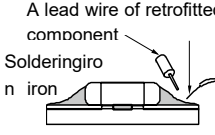
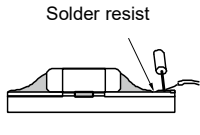
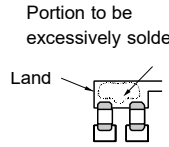
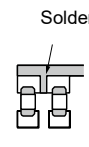
Item	Prohibited applications	Improved applications by pattern division
Mixed mounting with a component with lead wires	The lead wire of a component with lead wires 	Solder resist 
Arrangement near chassis	Chassis Solder(ground solder) Electrode pattern 	Solder resist 
Retro-fitting of component with lead wires	A lead wire of retrofitted component Soldering iron 	Solder resist 
Lateral arrangement	Portion to be excessively soldered Land 	Solder resist 

4-2.4 Component layout

To prevent the crack of Varistors, place it on the position that could not easily be affected by the bending stress of substrate while going through procedures after mounting or handling.

- (1) To minimize mechanical stress caused by the warp or bending of a PC board, please follow the recommended Varistors' layout below.

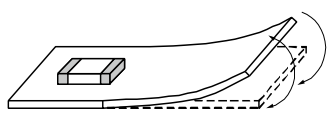
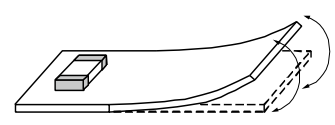
Prohibited layout	Recommended layout
	 Layout the Varistors sideways against the stressing direction.

- (2) The following layout is for your reference since mechanical stress near the dividing/breaking position of a PC board varies depending on the mounting position of the Varistors.

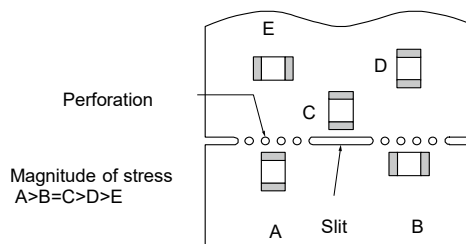

- (3) The magnitude of mechanical stress applied to the Varistors when dividing the circuit board in descending order is as follows: push back < slit < V-groove < perforation. Also take into account the layout of the Varistors and the dividing/breaking method.

4-2.5 Mounting density and spaces

If the spacing between components is too small, the effect of the solder bridge and solder ball will occur. Design the spacing so that the effect of the solder bridge and solder ball will not occur.

5. Precautions for assembly

5-1. Storage

- (1) The Varistors shall be stored between 5 to 40 °C and 20 to 70 % RH, not under severe conditions of high temperature and humidity.
- (2) If stored in a place where humidity, dust, or corrosive gasses (hydrogen sulfide, sulfurous acid, hydrogen chloride and ammonia, etc.) are contained, the solderability of terminal electrodes will be deteriorated.
Do not store tapes of taping-packaged products in the above environments as heat or direct sunlight may cause deformation of the tape or parts sticking to the tape, which may lead to problems during mounting.
- (3) Do not store components longer than 12 months. Check the solderability of products that have been stored for more than 12 months before use.

5-2. Adhesives for Mounting

- (1) The amount and viscosity of an adhesive for mounting shall be such that the adhesive will not flow off on the land during its curing.
- (2) If the amount of adhesive is insufficient for mounting, the Varistors may fall off after or during soldering.
- (3) Low-viscosity of the adhesive causes displacement of Varistors.
- (4) The heat-curing methods for adhesive are ultraviolet radiation, far-infrared radiation, and so on.
In order to prevent the terminal electrodes of the Varistors from oxidizing, the curing shall be under the following conditions: 160 °C max., for 2 minutes max.
- (5) Insufficient curing may cause the Varistors to fall off after or during soldering. In addition, insulation resistance between terminal electrodes may deteriorate due to moisture absorption. In order to prevent these problems, please observe proper curing conditions.

5-3. Chip Mounting Consideration

- (1) When mounting the Varistors components on a PC board, the Varistor bodies shall be free from excessive impact loads such as mechanical impact or stress due to the positioning, pushing force and displacement of vacuum nozzles during mounting.
- (2) Maintenance and inspection of the Chip Moulder must be performed regularly.
- (3) If the bottom dead center of the vacuum nozzle is too low, the Varistor will crack from excessive force during mounting. Please refer to the following precautions and recommendations.
 - (a) Set and adjust the bottom dead center of the vacuum nozzles to the upper surface of the PC board after correcting the warp of the PC board.
 - (b) Set the pushing force of the vacuum nozzle during mounting to 1 to 3 N in static load.
 - (c) For double surface mounting, apply a supporting pin on the rear surface of the PC board to suppress the bending of the PC board in order to minimize the impact of the vacuum nozzles. Typical examples are shown in the table below secondary.
 - (d) Adjust the vacuum nozzles so that their bottom dead center during mounting is not too low.

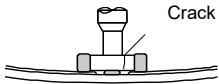
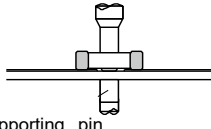
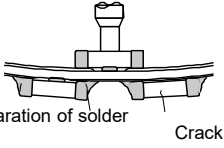
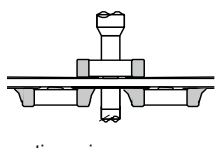
Item	Prohibited mounting	Recommended mounting
Single surface mounting	 <p>Crack</p>	 <p>Supporting pin</p> <p>The supporting pin does not necessarily have to be positioned beneath the Varistor.</p>
Double surface mounting	 <p>Separation of solder</p> <p>Crack</p>	 <p>Supporting pin</p>

- (4) The closing dimensions of the positioning chucks shall be controlled. Maintenance and replacement of positioning chucks shall be performed regularly to prevent chipping or cracking of the Varistors caused by mechanical impact during positioning due to worn positioning chucks.
- (5) Maximum stroke of the nozzle shall be adjusted so that the maximum bending of PC board does not exceed 0.5 mm at 90 mm span. The PC board shall be supported by an adequate number of supporting pins.

5-4. Selection of soldering flux

Soldering flux may seriously affect the performance of the Varistors. Please confirm enough whether the soldering flux have an influence on performance of the Varistors or not, before using.

5-5. Soldering

5-5.1 Flow soldering

When conducting flow soldering, stress from abrupt temperature change is applied to the Varistors, so the temperature, especially temperature of solder should be controlled very carefully. Varistors should not be subjected to abrupt temperature change because it causes occurrence of thermal cracks as a result of excessive thermal stress inside of the Varistors from flow soldering. You should be careful to temperature difference. If rapid heating or cooling is applied, excessive thermal stress due to a large temperature difference will be generated inside the varistor, which may cause thermal cracks. Therefore, observe for preheating and slow cooling as described below.

(1) Application of Soldering flux :

The soldering flux shall be applied to the mounted Varistors thinly and uniformly by foaming method.

(2) Preheating : Conduct sufficient pre-heating, and make sure that the temperature difference between solder and Varistors' surface is 150 °C or less.

(3) Immersion into Soldering bath :

The Varistors shall be immersed into a soldering bath of 240 to 260 °C for 3 to 5 seconds.

(4) Gradual Cooling : After soldering, avoid rapid cooling (forced cooling) and conduct gradual cooling, so that thermal cracks do not occur.

(5) Flux Cleaning : When the Varistors are immersed into a cleaning solvent, be sure that the surface temperatures of devices do not exceed 100 °C.

(6) Performing flow soldering once under the conditions shown in the figure below

[Recommended profile of Flow soldering (Ex.)] will not cause any problems.

However, pay attention to the possible warp and bending of the PC board.

Recommended profile of flow soldering (Ex.)

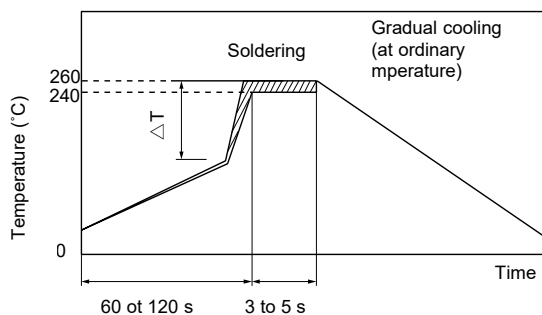

<ΔT: Allowable temperature difference>

Size / EIA	Temp. tol.
0603	$T \leq 150 \text{ }^{\circ}\text{C}$

For products specified in individual specifications, avoid flow soldering.

5-5.2 Reflow soldering

The reflow soldering temperature conditions are composed of temperature curves of Preheating, Temp. rise, Heating, Peak and Gradual cooling. Large temperature difference inside the Varistors caused by rapid heat application to the Varistors may lead to excessive thermal stresses, contributing to the thermal cracks. The Preheating temperature requires controlling with great care so that tombstone phenomenon may be prevented.

Recommended profile of Reflow Soldering (Ex.)

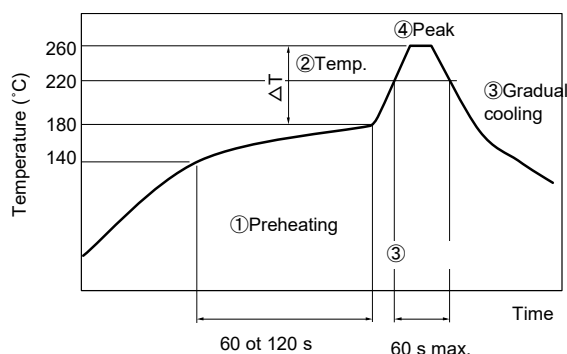

ΔT : Allowable temperature difference $\Delta T \leq 150 \text{ }^{\circ}\text{C}$

Item	Temperature	Period or speed
① Preheating	140 to 180 °C	60 to 120 s
② Temp. rise	Preheating temp to Peak temp.	2 to 5 °C / s
③ Heating	220 °C min.	60 s max.
④ Peak	260 °C max.	10 s max.
⑤ Gradual cooling	Peak temp. to 140 °C	1 to 4 °C / s

Size / EIA	Temp. tol.
0201 to 0805	$T \leq 150 \text{ }^{\circ}\text{C}$

The rapid cooling (forced cooling) during Gradual cooling part should be avoided, because this may cause defects such as the thermal cracks, etc. When the Varistors are immersed into a cleaning solvent, make sure that the surface temperatures of the devices do not exceed 100 °C. Performing reflow soldering twice under the conditions shown in the figure above [Recommended profile of Flow soldering (Ex.)] will not cause any problems.

However, pay attention to the possible warp and bending of the PC board.

Recommended soldering condition is for the guideline for ensuring the basic characteristics of the components, not for the stable soldering conditions. Conditions for proper soldering should be set up according to individual conditions. The temperature of this product at the time of mounting changes depending on mounting conditions, therefore, please confirm that Product surface becomes the specified temperature when mounting it on the end product.

5-5.3 Hand soldering

When soldering, stress is directly applied to the varistor body due to sudden temperature changes. Therefore, pay particular attention to the temperature control of the soldering iron tip. Be careful not to let the soldering iron tip directly touch the varistor body or terminal electrodes.

Varistors are particularly sensitive to rapid heating and cooling. Rapid heating and cooling can cause excessive thermal stress due to the large temperature difference inside the varistor, resulting in thermal cracks.

Therefore, observe for preheating and slow cooling as described below.

- Control the temperature of the soldering tips with special care.
- Avoid the direct contact of soldering tips with the Varistors and/or terminal electrodes.
- Do not reuse dismantled Varistors.

(1) Condition 1 (with preheating)

- (a) Soldering : Use thread solder ($\phi 1.0$ mm or below) which contains flux with low chlorine, developed for precision electronic equipment.
- (b) Preheating : Conduct sufficient preheating, and make sure that the temperature difference between solder and Varistors' surface is 150 °C or less.
- (c) Temperature of Iron tip: 350 °C max.
(The required amount of solder shall be melted in advance on the soldering tip.)
- (d) Gradual cooling : After soldering, the Varistors shall be cooled gradually at room temperature.

Recommended profile of Hand soldering (Ex.)

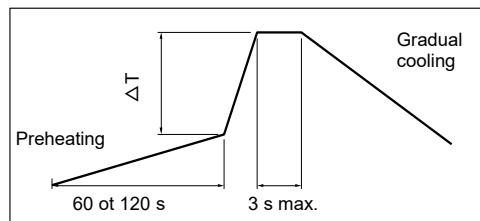

ΔT : Allowable temperature difference $\Delta T \leq 150$ °C

(2) Condition 2 (without preheating)

Hand soldering can be performed without preheating, by following the conditions below:

- (a) Make sure that the tip of the soldering iron does not directly touch the varistor body or terminal electrodes.
- (b) The lands are sufficiently preheated with a soldering iron tip before sliding the soldering iron tip to the terminal electrodes of the Varistors for soldering.

Conditions of hand soldering without preheating

Item	Condition
Temperature of Iron tip	270 °C max.
Wattage	20 W max.
Shape of Iron tip	$\phi 3$ mm max.
Soldering time with a soldering iron	3 s max.

5-6. Post soldering cleaning

5-6.1 Cleaning solvent

Soldering flux residue may remain on the PC board if cleaned with an inappropriate solvent. This may deteriorate the performance of Varistors, especially insulation resistance.

5-6.2 Cleaning conditions

Inappropriate cleaning conditions such as insufficient cleaning or excessive cleaning may impair the electrical characteristics and reliability of the Varistors.

(1) Insufficient cleaning can lead to :

- (a) The halogen substance found in the residue of the soldering flux may cause the metal of terminal electrodes to corrode.
- (b) The halogen substance found in the residue of the soldering flux on the surface of the Varistors may change resistance values.
- (c) Water-soluble soldering flux may have more remarkable tendencies of (a) and (b) above compared to those of rosin soldering flux.

(2) Excessive cleaning can lead to :

- (a) When using ultrasonic cleaner, make sure that the output is not too large, so that the substrate will not resonate. The resonance causes the cracks in Varistors and/or solders, and deteriorates the strength of the terminal electrodes. Please follow these conditions for Ultrasonic cleaning:

Ultrasonic wave output : 20 W/L max.

Ultrasonic wave frequency : 40 kHz max.

Ultrasonic wave cleaning time : 5 min. max.

5-6.3 Contamination of cleaning solvent

Cleaning with contaminated cleaning solvent may cause the same results as that of insufficient cleaning due to the high density of liberated halogen.

5-7. Inspection process

The pressure from measuring terminal pins might bend the PCB when implementing circuit inspection after mounting Varistors on PCB, and as a result, cracking may occur.

- (1) Mounted PC boards shall be supported by an adequate number of supporting pins on the back with bend settings of 90 mm span 0.5 mm max.
- (2) Confirm that the measuring pins have the right tip shape, are equal in height, have the right pressure and are set in the correct positions. The following figures are for your reference to avoid bending the PC board.

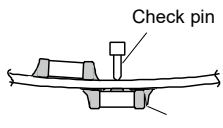
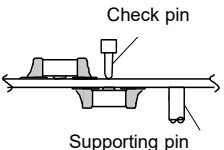
Item	Prohibited mounting	Recommended mounting
Bending of PC board	 <p>Separated, Crack</p>	 <p>Supporting pin</p>

5-8. Protective coating

Make sure characteristics and reliability when using the resin coating or resin embedding for the purpose of improvement of humidity resistance or gas resistance, or fixing of parts because failures of a thermistors such as 1), 2) and 3) may be occurred.

- (1) The solvent which contained in the resin permeate into the Varistors, and it may deteriorate the characteristic.
- (2) When hardening the resin, chemical reaction heat (curing heat generation) happen and it may occurs the infection to the Varistors.
- (3) The lead wire might be cut down and the soldering crack might be happen by expansion or contraction of resin hardening.

5-9. Dividing / Breaking of PC boards

- (1) Please be careful not to stress the substrate with bending/twisting when dividing, after mounting components including Varistors. Abnormal and excessive mechanical stress such as bending or torsion shown below can cause cracking in the Varistors.

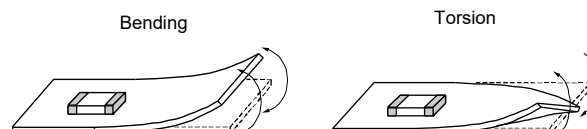

- (2) Dividing/Breaking of the PC boards shall be done carefully at moderate speed by using a jig or apparatus to prevent the Varistors on the boards from mechanical damage.

- (3) Examples of PCB dividing/breaking jigs: The outline of PC board breaking jig is shown below. When PC board are broken or divided, loading points should be close to the jig to minimize the extent of the bending. Also, planes with no parts mounted on should be used as plane of loading, in order to prevent tensile stress induced by the bending, which may cause cracks of the Varistors or other parts mounted on the PC boards.

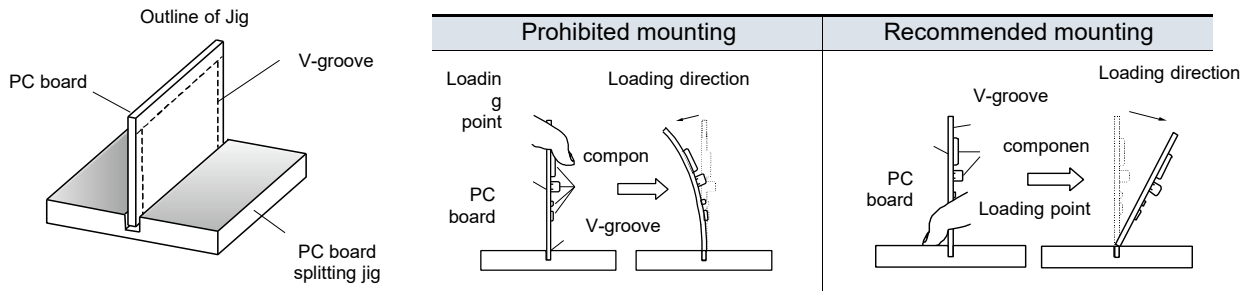

5-10. Mechanical Impact

- (1) The Varistors shall be free from any excessive mechanical impact. The Varistor body is made of ceramics and may be damaged or cracked if dropped. Never use a Varistor which has been dropped; their quality may already be impaired, and in that case, failure rate will increase.
- (2) When handling PC boards with Varistors mounted on them, do not allow the Varistors to collide with another PC board. When mounted PC boards are handled or stored in a stacked state, the corner of a PC board might strike Varistors, and the impact of the strike may cause damage or cracking and can deteriorate the withstand voltage and insulation resistance of the Varistor.

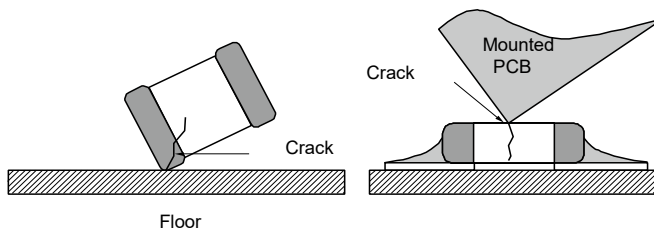

5-11. Do not reuse this product after removal from the mounting board.

6. Precautions for discarding

As to the disposal of the Varistors, check the method of disposal in each country or region where the modules are incorporated in your products to be used.

7. Other

The various precautions described above are typical. For special mounting conditions, please contact us.

8. Applicable laws and regulations , others

1. This product not been manufactured with any ozone depleting chemical controlled under the Montreal Protocol.
2. This product comply with RoHS(Restriction of the use of certain Hazardous Substance in electrical and electronic equipment) (DIRECTIVE 2011/65/EU and 2015/863/EU).
3. All the materials used in this part are registered material under the Law Concerning the Examination and Regulation of Manufacture, etc. of Chemical Substance.
4. If you need the notice by letter of "A preliminary judgement on the Laws of Japan foreign exchange and Foreign Trade Control", be sure to let us know.
5. These products are not dangerous goods on the transportation as identified by UN (United nations) numbers or UN classification.
6. The technical information in this catalog provides example of our products' typical operations and application circuit. We do not guarantee the non-infringement of third party's intellectual property rights and we do not grant any license, Right or interest in our intellectual property.

Multilayer Varistor

For ESD pulse

[DC voltage lines/High speed signal lines]

EZJZ, EZJP series

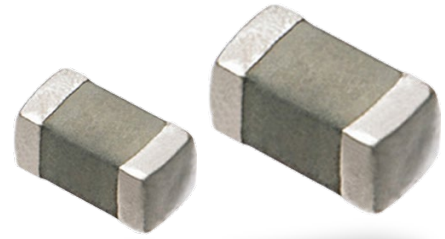

Features

- Excellent ESD suppression due to original advanced material technology
- Having large electrostatic resistance meeting IEC61000-4-2, Level 4 standard
- Having no polarity (bipolar) facilitated replacing Zener Diodes. Capable of replacing 2 Zener Diodes and 1 Capacitor.
- Lead-free plating terminal electrodes enabling great solderability
- Wide range of products is available by adopting multilayer structure, meeting various needs
- Low capacitance versions for DC voltage lines of high speed busses
- Ultra low capacitance for high speed signal line
- Applicable to high-speed signal lines, such as interfaces (e.g. USB2.0, IEEE1394, HDMI, and so on), due to our original ultra-low capacitance technology.
- RoHS compliant

Explanation of part numbers

1	2	3	4	5	6	7	8	9	10	11	12	
E	Z	J	Z	0	V	2	7	0	E	A		Example
Product code										Design code		

Code	Series	Code	Packaging style	Nominal varistor voltage				Code	Cap.	Code	Cap.	Code	Design code
Z	EZJZ	V	0402, 0603 Paper taping	The first and second digits denote the first 2 numbers of the varistor voltage and the third digit indicates the number of zeros following. The decimal point denotes in R.				A	3 pF	G	100 pF	Nil	Cap.Tolerance : max.
P	EZJP							R	20 pF	H	150 pF	B	Cap.Tolerance : ± 0.1 pF
								D	27 pF	J	220 pF	C	Cap.Tolerance : ± 0.25 pF
								E	47 pF	K	330 pF	D	Cap.Tolerance : ± 0.50 pF
								W	56 pF	M	680 pF	K	Cap.Tolerance : ± 10 %
								F	68 pF			M	Cap.Tolerance : ± 20 %

Code	Dimensions (mm) (inch)
Z	0603 (0201)
0	1005 (0402)
1	1608 (0603)

※ Below 3 pF, the 10 or 11th position of the P/N indicates the capacitance value as follows : 2.0 pF ...20, 1.5 pF...15

Construction

No.	Name	
①	Semiconductive ceramics	
②	Internal electrode	
③	Terminal electrode	Substrate electrode
④		Intermediate electrode
⑤		External electrode

Dimensions in mm (not to scale)

Size code	Size (inch)	L	W	T	L ₁ , L ₂
Z	0201	0.60 ± 0.03	0.30 ± 0.03	0.30 ± 0.03	0.15 ± 0.05
0	0402	1.00 ± 0.05	0.50 ± 0.05	0.50 ± 0.05	0.2 ± 0.1
1	0603	1.6 ± 0.1	0.8 ± 0.1	0.8 ± 0.1	0.3 ± 0.2

Unit : mm

Multilayer Varistor

Low capacitance type [High speed signal lines]

Features

- Applicable to high-speed signal lines, such as interfaces (e.g. USB 2.0, IEEE1394, HDMI, and so on), due to our original material technology and multilayer technology.
- Capacitance : 0.8 to 2.1 pF typ.

Recommended applications

Mobile phone	Antenna circuit, External IF
DSC,DVC	USB2.0, IEEE1394
PC,PDA	USB2.0, IEEE1394, LAN1000BASE
TV,DVD	USB2.0, IEEE1394, HDMI
Game console	Controller, External IF

Ratings and characteristics

Size(inch)	Part No.	Maximum allowable voltage DC (V)	Nominal varistor voltage at 1 mA (V)	Capacitance at 1 MHz (pF)	Maximum ESD IEC61000-4-2
0402	EZJZ0V80010	10	80	1 max. [0.8 typ.]	Contact discharge : 8 kV
	EZJZ0V80015D	5	80	1.5±0.5	
	EZJZ0V500AA	5	50	3 max. [2.1 typ.]	
	EZJZ0V800AA	18	80	3 max. [2.1 typ.]	
	EZJZ0V171AA	18	170	3 max. [2.1 typ.]	
0603	EZJZ1V80010	10	80	1 max. [0.8 typ.]	
	EZJZ1V500AA	5	50	3 max. [2.1 typ.]	
	EZJZ1V800AA	18	80	3 max. [2.1 typ.]	
	EZJZ1V171AA	18	170	3 max. [2.1 typ.]	

- Operating temperature range : -40 to 85 °C

* Recommend soldering method : Reflow soldering

Voltage vs. Current

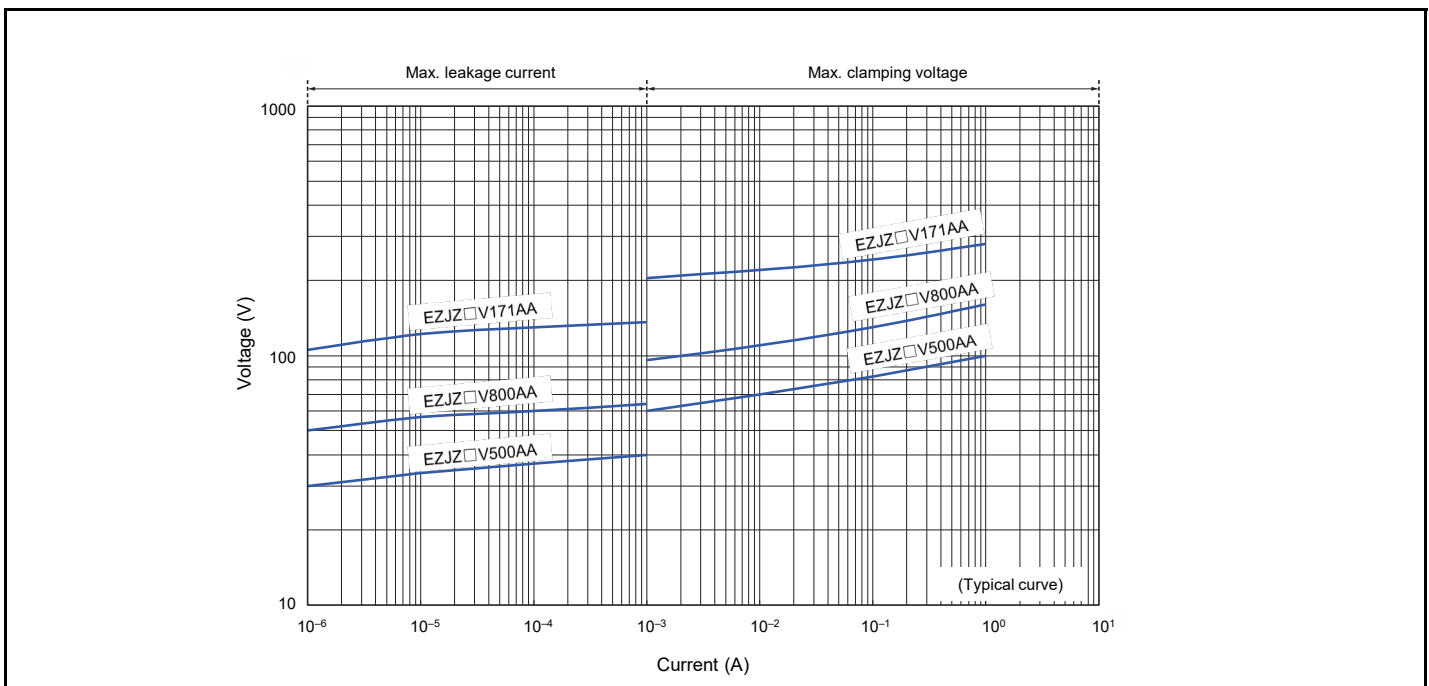

Low capacitance type [High speed signal lines] / EZJZ, EZJP series

Capacitance vs. Frequency

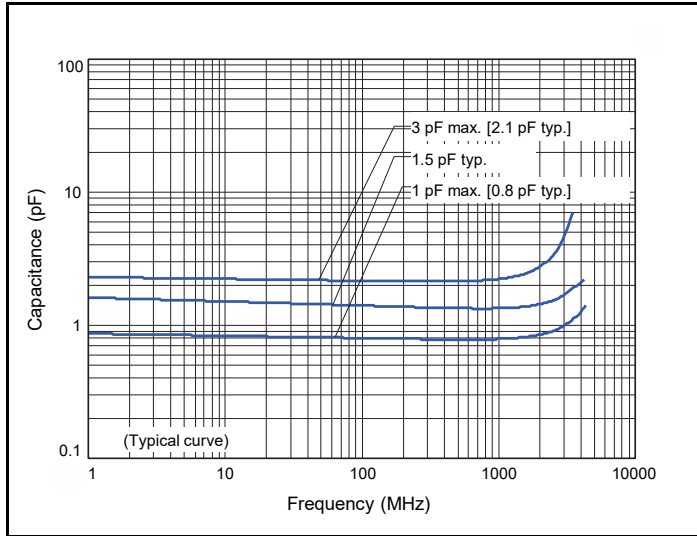

Impedance vs. Frequency

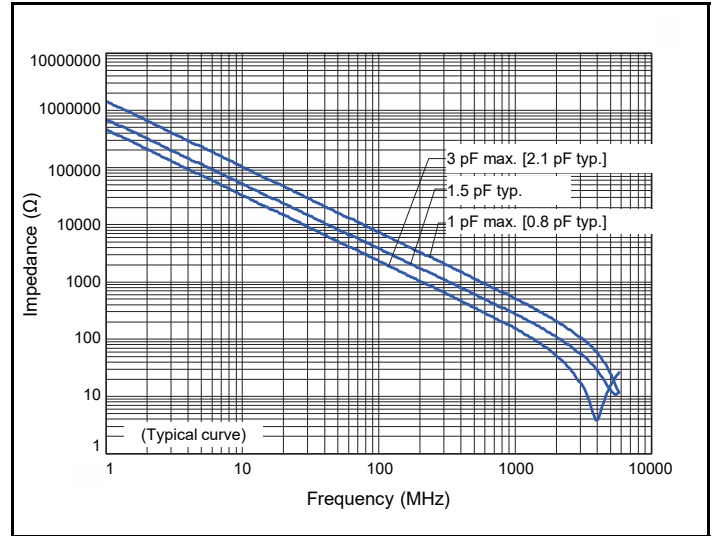

Attenuation vs. Frequency

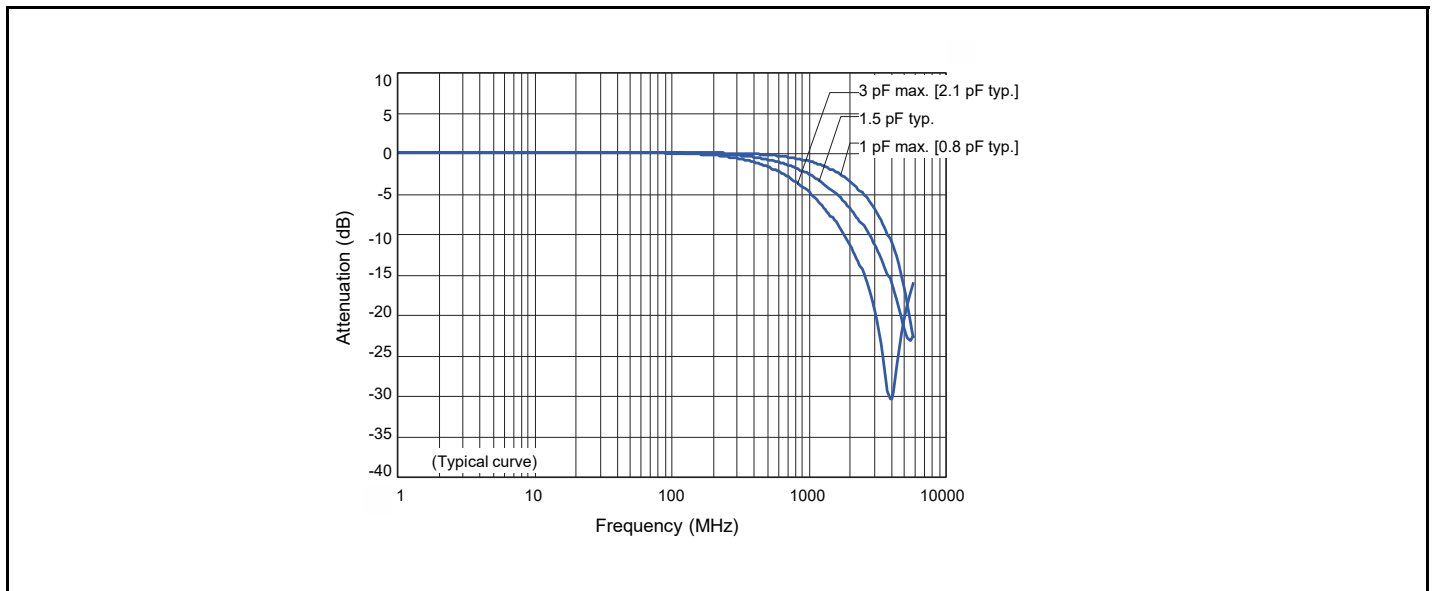

Multilayer Varistor

Low voltage type (Standard type)

[DC voltage lines/Low speed signal lines]

Features

Wide variety of products is available by adopting multilayer construction, which achieved wide range of usage, such as application to DC voltage lines and signal lines.

- Varistor voltage: 6.8 to 65 V (at 1 mA)
- Capacitance :8.5 to 420 pF typ. (at 1 MHz)

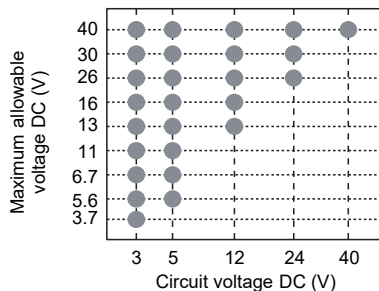

Recommended Applications

Mobile phone	SW, LCD, LED, Audio terminal, Battery pack, Memory card, External IF
DSC,DVC	SW, LCD, LED, USB
PC,PDA	SW, LCD, LED, USB
TV,DVD	Audio, Video terminal
Audio	Audio terminal, Microphone, Receiver
Game console	Controller, External IF

Ratings and characteristics

Size (inch)	Part No.	Maximum allowable voltage DC (V)	Nominal varistor voltage at 1 mA (V)	Capacitance (pF)		Maximum peak current at 8/20 μs, 2 times (A)	Maximum ESD IEC61000-4-2
				at 1 MHz	at 1 kHz		
0201	EZJPZV6R8JA	3.7	6.8	220 max. [150 typ.]	175 typ.	5	Contact discharge :8 kV
	EZJPZV6R8GA	3.7	6.8	100 max. [85 typ.]	100 typ.	5	
	EZJPZV080GA	5.6	8	100 max. [85 typ.]	100 typ.	5	
	EZJPZV120GA	7.5	12	100 max. [85 typ.]	100 typ.	5	
	EZJPZV120DA	7.5	12	27 max. [22 typ.]	33 typ.	1	
	EZJPZV120RA	7.5	12	20 max. [15 typ.]	18 typ.	1	
	EZJPZV150RA	9	15	20 max. [15 typ.]	18 typ.	1	
	EZJPZV270RA	16	27	20 max. [15 typ.]	16.5 typ.	1	
EZJPZV270BA	16	27	10 max. [8.5 typ.]	10 typ.	1		
0402	EZJP0V6R8MA	3.7	6.8	680 max. [420 typ.]	650 typ.	20	
	EZJP0V6R8GA	3.7	6.8	100 max. [85 typ.]	100 typ.	3	
	EZJP0V080MA	5.6	8	680 max. [420 typ.]	650 typ.	20	
	EZJP0V080KA	5.6	8	330 max. [290 typ.]	480 typ.	15	
	EZJP0V080GA	5.6	8	100 max. [65 typ.]	100 typ.	3	
	EZJP0V080DA	5.6	8	27 max. [22 typ.]	33 typ.	1	
	EZJP0V120JA	7.5	12	220 max. [150 typ.]	175 typ.	10	
	EZJZ0V180HA	11	18	150 max. [120 typ.]	140 typ.	10	
	EZJZ0V220HA	13	22	150 max. [100 typ.]	116 typ.	10	
	EZJP0V270EA	16	27	47 max. [33 typ.]	37 typ.	4	
	EZJP0V270RA	16	27	20 max. [15 typ.]	16.5 typ.	1	
	EZJZ0V420WA	30	42	56 max. [40 typ.]	45 typ.	10	
EZJZ0V650DA	40	65	27 max. [22 typ.]	33 typ.	5		
0603	EZJP1V120KA	7.5	12	330 max. [250 typ.]	290 typ.	20	
	EZJZ1V180JA	11	18	220 max. [180 typ.]	210 typ.	20	
	EZJZ1V220JA	13	22	220 max. [160 typ.]	185 typ.	20	
	EZJZ1V270GA	16	27	100 max. [85 typ.]	100 typ.	20	
	EZJZ1V270EA	16	27	47 max. [33 typ.]	37 typ.	20	
	EZJZ1V270RA	16	27	20 max. [15 typ.]	16.5 typ.	3	
	EZJZ1V330GA	26	33	100 max. [85 typ.]	100 typ.	20	
	EZJZ1V420FA	30	42	68 max. [55 typ.]	63 typ.	15	
EZJZ1V650DA	40	65	27 max. [22 typ.]	33 typ.	5		

● Operating Temperature Range : -40 to 85 °C

* Recommend soldering method : Reflow soldering

Maximum allowable voltage	Maximum DC Voltage that can be applied continuously within the operating temperature range
Varistor voltage	Varistor starting voltage between terminals at DC 1 mA, also known as Breakdown voltage
Maximum peak current	Maximum current that can be withstood under the standard pulse 8/20 μs, 2 times based
Maximum ESD	Maximum voltage that can be withstood under ESD based on IEC61000-4-2, 10 times (5 times of each positive-negative polarity)

Voltage vs. Current

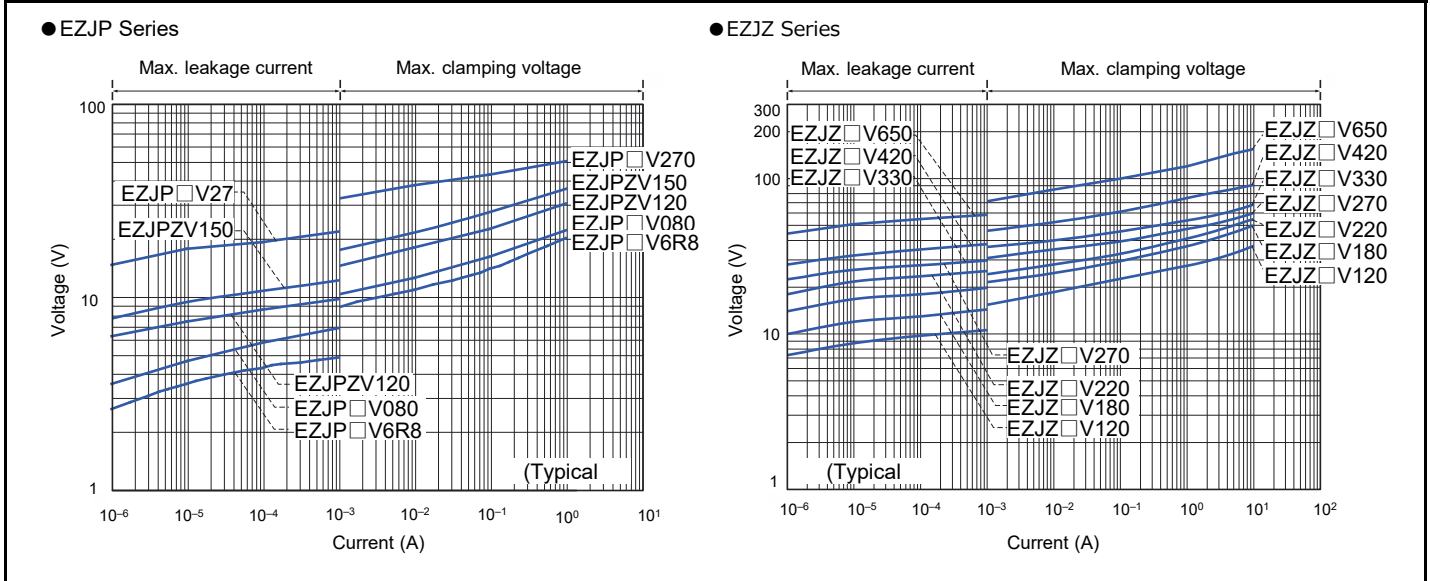

Capacitance vs. Frequency

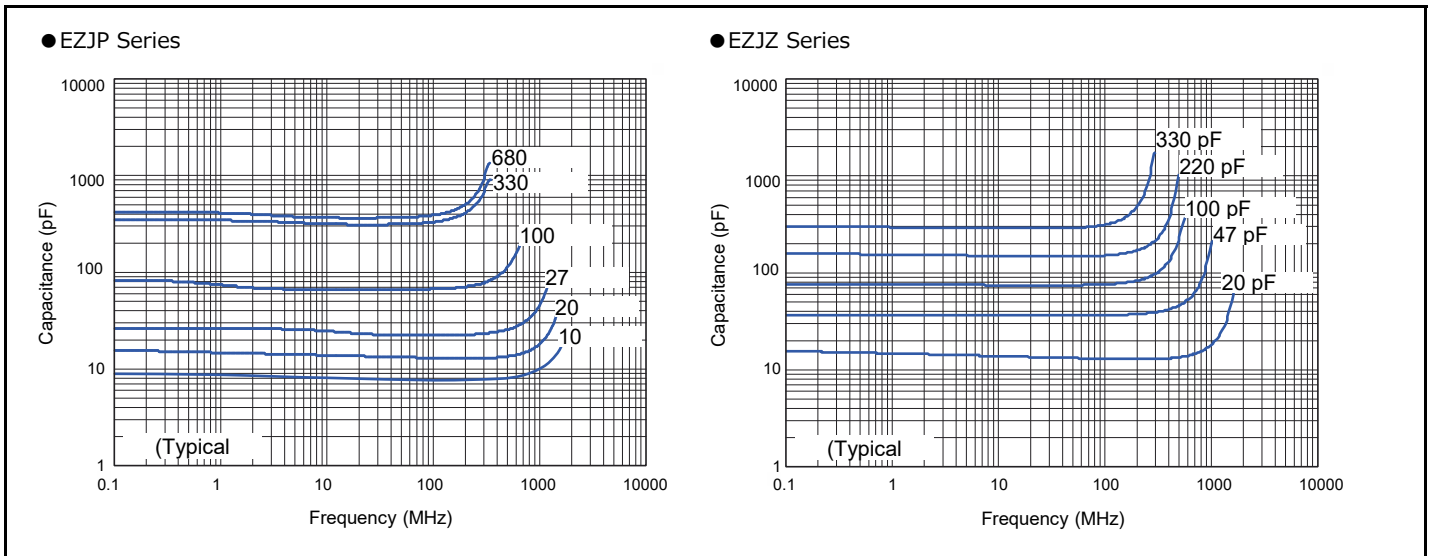

Attenuation vs. Frequency

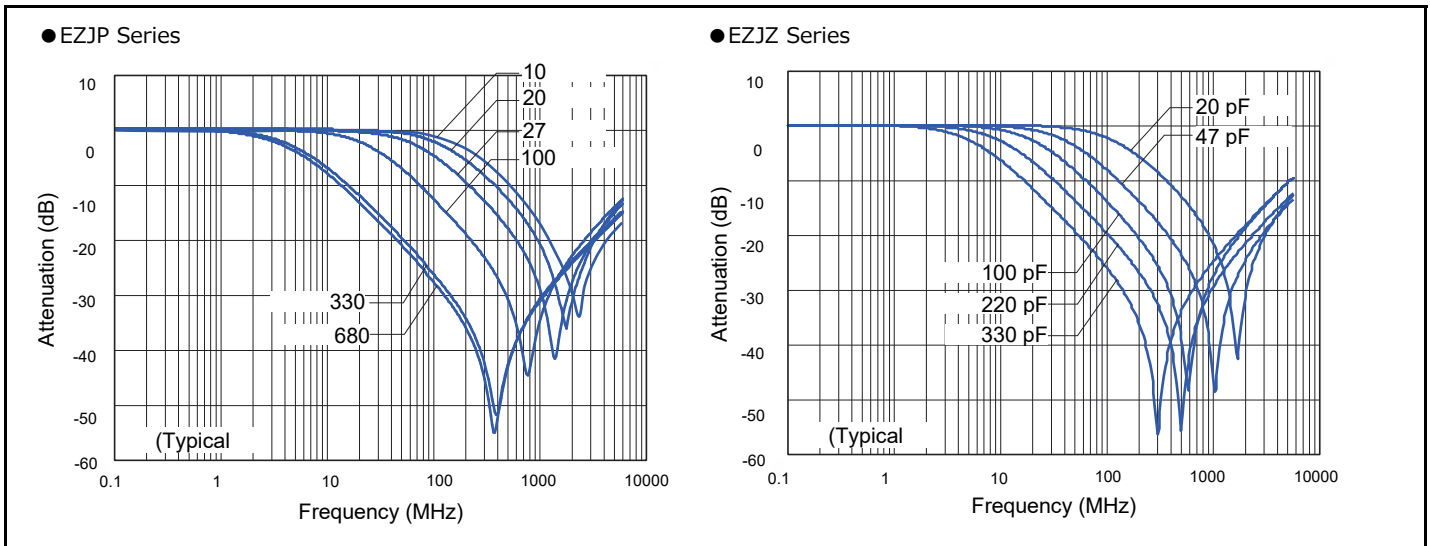

■ As for packaging methods, handling precautions please see data files

Multilayer Varistor

For ESD pulse [DC voltage lines]

EZJS series

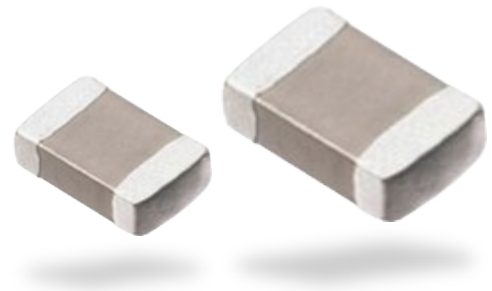

Features

- Excellent ESD suppression due to original advanced material technology
- Having large electrostatic resistance meeting IEC61000-4-2, Special Level 30 kV standard
- Having no polarity (bipolar) facilitated replacing Zener Diodes. Capable of replacing 2 Zener Diodes and 1 Capacitor.
- Lead-free plating terminal electrodes enabling great solderability
- RoHS compliant

Explanation of part numbers

1	2	3	4	5	6	7	8	9	10	11	12	
E	Z	J	S	2	Y	D	4	7	2			Example
Product code			Series code						Design code			

Code	Dimensions (mm) (inch)	Code	Packaging style code	Code	Max. allowable voltage code	Nominal varistor voltage
1	1608 (0603)	V	∅ 180 reel, Paper taping	B	DC 6 V	The first and second digits denote the first 2 numbers of the varistor voltage and the third digit indicates the number of zeros following.
2	2012 (0805)	Y	∅ 180 reel, Embossed taping	C	DC 18 V	
				D	DC 30 V	

Construction

No.	Name
①	Semiconductive Ceramics
②	Internal electrode
③	Substrate electrode
④	Intermediate electrode
⑤	External electrode

Dimensions in mm (not to scale)

Size code	Size (inch)	L	W	T	L ₁ , L ₂	Unit : mm
1	0603	1.60 ± 0.15	0.8 ± 0.1	0.8 ± 0.1	0.3 ± 0.2	
2	0805	2.0 ± 0.2	1.25 ± 0.20	0.8 ± 0.2	0.50 ± 0.25	
				1.25 ± 0.20		

Ratings and Characteristics

Size (inch)	Part No.	Maximum allowable voltage DC (V)	Nominal varistor voltage at 0.1 mA (V)	Capacitance at 1 kHz (pF)	Maximum ESD IEC61000-4-2
0603	EZJS1VB822	6	12	8200 typ.	Contact discharge : 30 kV
	EZJS1VC392	18	30	3900 typ.	
	EZJS1VD182	30	50	1800 typ.	
0805	EZJS2VB223	6	12	22000 typ.	
	EZJS2YC822	18	30	8200 typ.	
	EZJS2YD472	30	50	4700 typ.	

● Operating Temperature Range : -40 to 85 °C

* Avoid flow soldering.

Voltage vs. Current

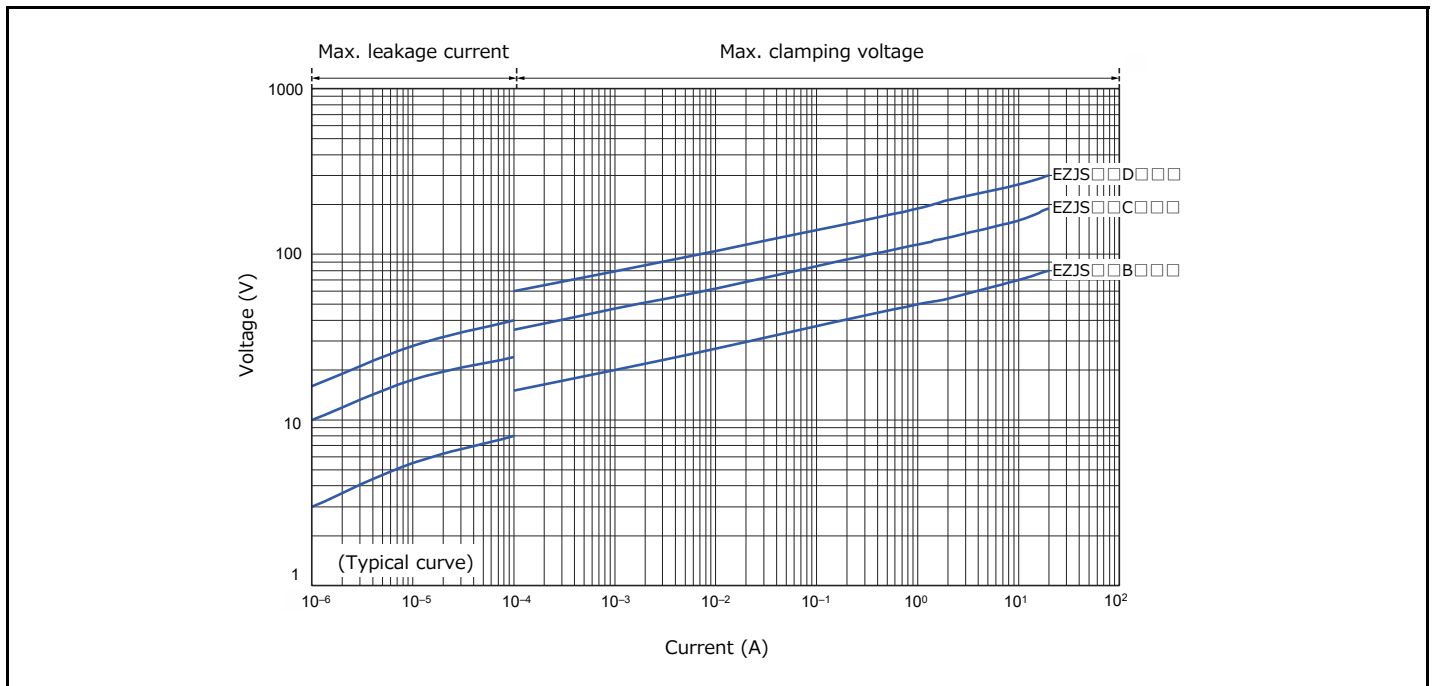

Capacitance vs. Frequency

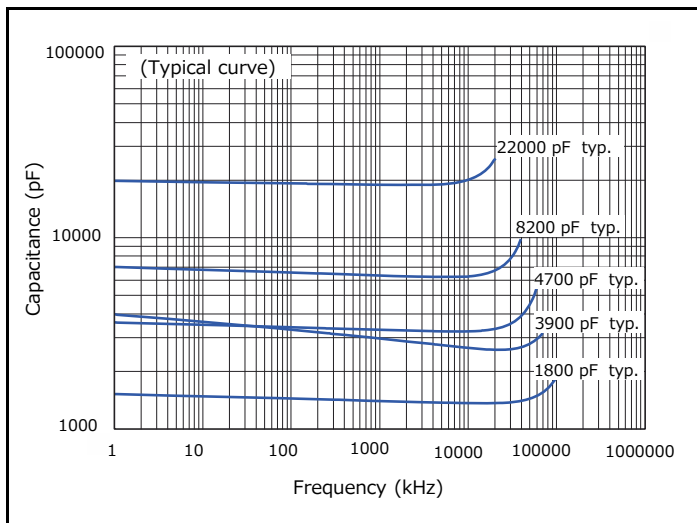

Attenuation vs. Frequency

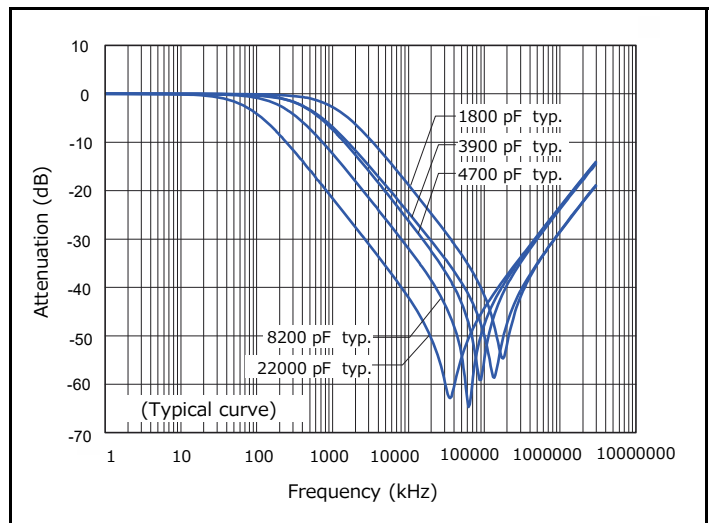

■ As for packaging methods, handling precautions please see data files

Varistor characteristics and equivalent circuit

A Multilayer Varistor does not have an electrical polarity like zener diodes and is equivalent to total 3 pcs of 2 zener diodes and 1 capacitor.

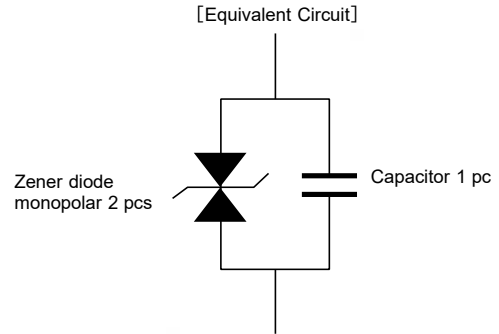
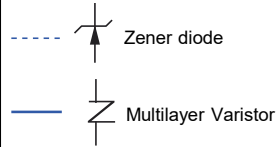
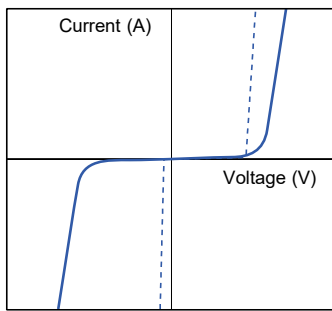

ESD Suppressive effects

Typical effects of ESD suppression

Test conditions :

IEC61000-4-2* Level4 Contact discharge, 8 kV

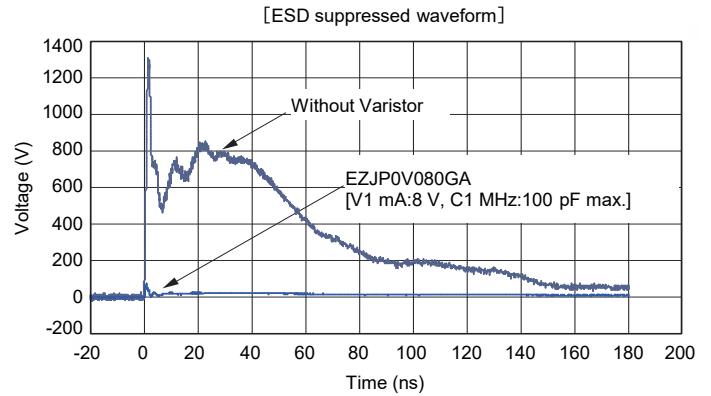
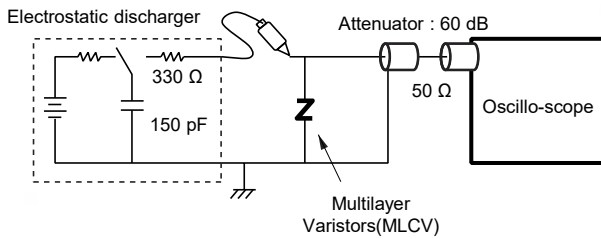

*IEC61000-4-2 ... International Standard of the ESD testing method (HBM) for electronic equipment ability to withstand ESD generated from a human body. It sets 4 levels of severity

Severity	Level 1	Level 2	Level 3	Level 4
Contact discharge	2 kV	4 kV	6 kV	8 kV
Air discharge	2 kV	4 kV	8 kV	15 kV

Replacement of zener diode

Replacing "Zener diode and Capacitor" with Multilayer Varistor saves both the mounting area and number of components used.

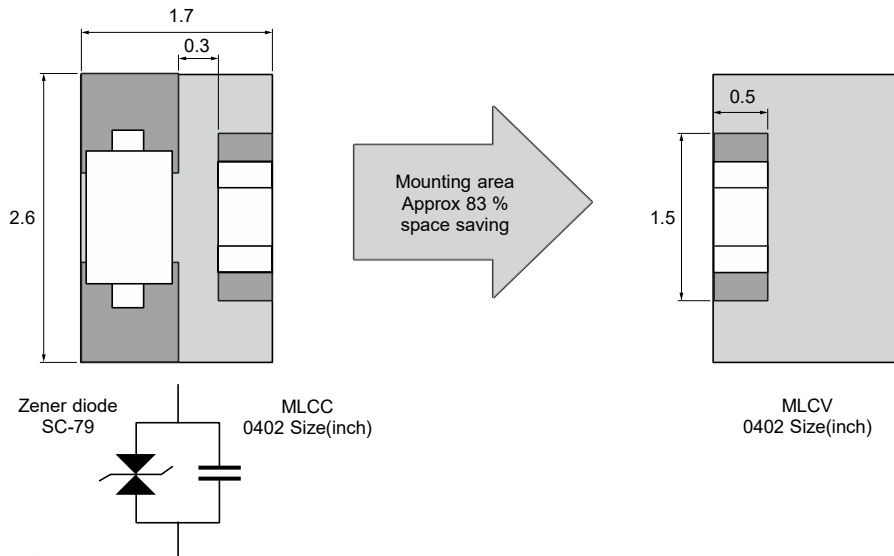

Unit : mm

Recommended applications

Applications	Series	Circuit				
		DC	1k	1M	1G (Hz)	
Mobile phones, DSC, PC, PDA, HDD TV(PDP, LC etc.), DVD, DVC, Game consoles, Audio equipment	EZJZ, EZJP	Ultra low capacitance (Cap. : 3 pF or less)				DC to GHz Antenna, RF circuit, LVDS, USB, IEEE1394, HDMI etc.
		Low capacitance (Cap. : 20 to 680 pF)				DC to tens of Hz PWR, SW, Audio terminals LCD, RS232C, etc.
PWR, Photoelectric sensors, SSR, Motors, Pressure sensors, Proximity switches	EZJS	High capacitance (Cap. : 1800 to 22000 pF)				DC to several kHz PWR, SW, Audio terminals, etc.

Applications

- Smart phone**
 - [Key/SW/LED]
 - [Condenser microphone]
 - [Audio (Mic, Speaker, Head set)]
 - [I/O, USB]
 - [Battery pack]

- USB1.1/2.0 lines**

- IEEE1394 lines**

- HDMI lines**

Multilayer Varistors EZJZ, EZJP, EZJS series / Performance and testing

Performance and testing methods

Characteristics	Specifications	Testing method															
Standard test conditions		Electrical characteristics shall be measured under the following conditions. Temp. : 5 to 35 °C, Relative humidity : 85 % or less															
Varistor voltage	To meet the specified value	The Varistor voltage is the voltage (V_C or V_{CmA}) between both end terminals of a Varistor when specified current (CmA) is applied to it. The measurement shall be made as quickly as possible to avoid heating effects.															
Maximum allowable voltage	To meet the specified value	The maximum DC voltage that can be applied continuously to a varistor.															
Capacitance	To meet the specified value	Capacitance shall be measured at the specified frequency, bias voltage 0 V, and measuring voltage 0.2 to 2.0 Vrms															
Maximum peak current	To meet the specified value	The maximum current measured (Varistor voltage tolerance is within $\pm 10\%$) when a standard impulse current of 8/20 μ seconds is applied twice with an interval of 5 minutes.															
Maximum ESD	To meet the specified value	The maximum ESD measured (while the varistor voltage is within $\pm 30\%$ of its nominal value) when exposed to ESD 10 times (five times for each positive-negative polarity) based on IEC61000-4-2.															
Solder ability	To meet the specified value	The part shall be immersed into a soldering bath under the conditions below. Solder : Sn-3.0Ag-0.5Cu Soldering flux : Ethanol solution of rosin (Concentration approx. 25 wt%) Soldering temp. : 230 \pm 5 °C Period : 4 \pm 1 s Soldering position : Immerse both terminal electrodes until they are completely into the soldering bath.															
Resistance to soldering heat	$\Delta V_C/V_C$: within $\pm 10\%$	After the immersion, leave the part for 24 \pm 2 hours under the standard condition, then evaluate its characteristics. Soldering conditions are specified below: Soldering conditions : 270 °C , 3 s / 260 °C , 10 s Soldering position : Immerse both terminal electrodes until they are completely into the soldering bath.															
Temperature cycling	$\Delta V_C/V_C$: within $\pm 10\%$	After repeating the cycles stated below for specified number of times, leave the part for 24 \pm 2 hours, then evaluate its characteristics. Cycle : 5 cycles <table border="1" style="margin-left: auto; margin-right: auto; border-collapse: collapse;"> <thead> <tr style="background-color: #e0e0e0;"> <th style="width: 10%;">Step</th> <th style="width: 50%;">Temperature</th> <th style="width: 40%;">Period</th> </tr> </thead> <tbody> <tr> <td style="text-align: center;">1</td> <td>Max. Operating Temp.</td> <td style="text-align: center;">30\pm3 min</td> </tr> <tr> <td style="text-align: center;">2</td> <td>Ordinary temp.</td> <td style="text-align: center;">3 min max.</td> </tr> <tr> <td style="text-align: center;">3</td> <td>Min. Operating Temp.</td> <td style="text-align: center;">30\pm3 min</td> </tr> <tr> <td style="text-align: center;">4</td> <td>Ordinary temp.</td> <td style="text-align: center;">3 min max.</td> </tr> </tbody> </table>	Step	Temperature	Period	1	Max. Operating Temp.	30 \pm 3 min	2	Ordinary temp.	3 min max.	3	Min. Operating Temp.	30 \pm 3 min	4	Ordinary temp.	3 min max.
Step	Temperature	Period															
1	Max. Operating Temp.	30 \pm 3 min															
2	Ordinary temp.	3 min max.															
3	Min. Operating Temp.	30 \pm 3 min															
4	Ordinary temp.	3 min max.															
Biased humidity	$\Delta V_C/V_C$: within $\pm 10\%$	After conducting the test under the conditions specified below, leave the part 24 \pm 2 hours, then evaluate its characteristics. Temp. : 40 \pm 2 °C Humidity : 90 to 95 %RH Applied voltage : Maximum allowable voltage (Individually specified) Period : 500+24/0 h															
High temperature exposure (dry heat)	$\Delta V_C/V_C$: within $\pm 10\%$	After conducting the test under the conditions specified below, leave the part 24 \pm 2 hours, then evaluate its characteristics. Temp. : Maximum operating temperature ± 3 °C (Individually specified) Applied voltage : Maximum allowable voltage (Individually specified) Period : 500+24/0 h															

Packaging methods (Taping)

● Standard quantity

Series	Size code (inch size)	Thickness (mm)	Kind of taping	Pitch (mm)	Quantity (pcs/reel)
EZJZ, EZJP	Z(0201)	0.3	Pressed carrier taping	2	15000
	0(0402)	0.5			10000
	1(0603)	0.8	Punched carrier taping	4	4000
EZJS	1(0603)	0.8			4000
	2(0805)	0.8			5000
		1.25	Embossed carrier taping		2000

● 2 mm Pitch (Pressed carrier taping) Size 0201

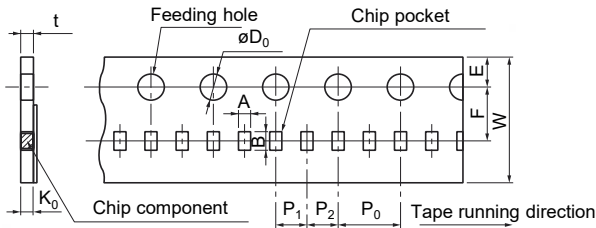

Unit : mm

Code	A	B	W	F	E	P ₁	P ₂	P ₀	øD ₀	t	K ₀
EZJZ EZJP	0.36 ±0.03	0.66 ±0.03	8.0 ±0.2	3.50 ±0.05	1.75 ±0.10	2.00 ±0.05	2.00 ±0.05	4.0 ±0.1	1.5 +0.1 0	0.55 max	0.36 ±0.03

● 4 mm pitch (Embossed carrier taping) Size 0805

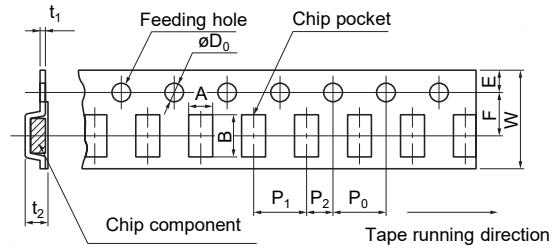

Unit : mm

Code	A	B	W	F	E	P ₁	P ₂	P ₀	øD ₀	t ₁	t ₂
EZJS	1.55 ±0.20	2.35 ±0.20	8.0 ±0.2	3.50 ±0.05	1.75 ±0.10	4.0 ±0.1	2.00 ±0.05	4.0 ±0.1	1.5 +0.1 0	0.6 max	1.5 max

● 2 mm Pitch (Punched carrier taping) Size 0402

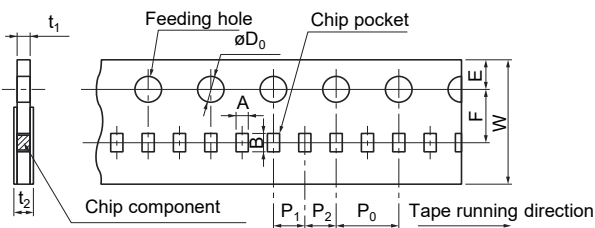

Unit : mm

Code	A	B	W	F	E	P ₁	P ₂	P ₀	øD ₀	t ₁	t ₂
EZJZ EZJP EZJS	0.62 ±0.05	1.12 ±0.05	8.0 ±0.2	3.50 ±0.05	1.75 ±0.10	2.00 ±0.05	2.00 ±0.05	4.0 ±0.1	1.5 +0.1 0	0.7 max	1.0 max

● Reel for taping

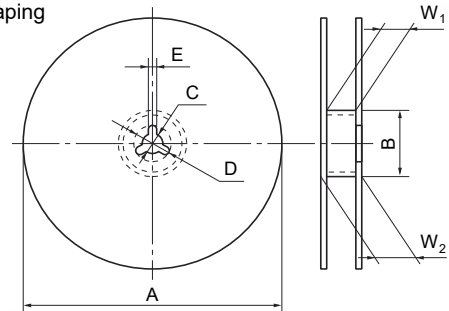

Unit : mm

Code	A	B	C	D	E	W ₁	W ₂
EZJZ EZJP EZJS	ø180 ⁰ ₋₃	ø60.0 ^{+1.0} ₀	13.0 _{±0.5}	21.0 _{±0.8}	2.0 _{±0.5}	9.0 ^{+1.0} ₀	11.4 _{±1.0}

● 4 mm Pitch (Punched carrier taping)

Size 0603, 0805, 0504/2 Array

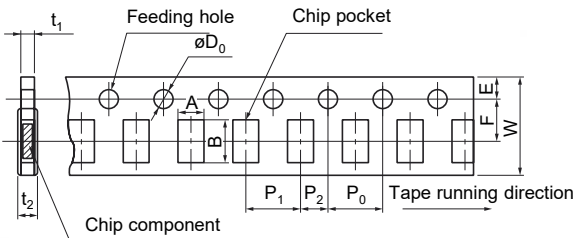

Unit : mm

Size code (inch size)	A	B	W	F	E	P ₁	P ₂	P ₀	øD ₀	t ₁	t ₂
1 (0603)	1.0 ±0.1	1.8 ±0.1	8.0 ±0.2	3.50 ±0.05	1.75 ±0.10	4.0 ±0.1	2.00 ±0.05	4.0 ±0.1	1.5 +0.1 0	1.1 max	1.4 max
S (0504 2 Array)	1.18 ±0.10	1.63 ±0.10									
2 (0805)	1.65 ±0.20	2.4 ±0.2									

● Leader part and taped end

Leader part

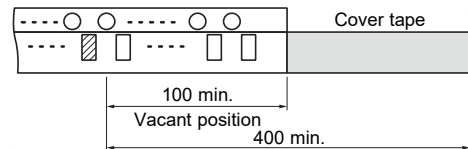

Tape end

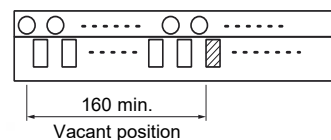

Unit : mm

Safety Precautions

When using our products, no matter what sort of equipment they might be used for, be sure to confirm the applications and environmental conditions with our specifications in advance.

Panasonic
INDUSTRY

Panasonic Industry Co., Ltd.
Device Solutions Business Division

1006 Kadoma, Kadoma City, Osaka
571-8506 Japan