

Antenna

YC0013AA Datasheet

Antenna Services

Version: 2.3

Date: 2021-07-08

Status: Released



Our aim is to provide customers with timely and comprehensive service. For any assistance, please contact our company headquarters:

Quectel Wireless Solutions Co., Ltd.

Building 5, Shanghai Business Park Phase III (Area B), No.1016 Tianlin Road, Minhang District, Shanghai 200233, China

Tel: +86 21 5108 6236

Email: info@quectel.com

Or our local office. For more information, please visit:

<http://www.quectel.com/support/sales.htm>.

For technical support, or to report documentation errors, please visit:

<http://www.quectel.com/support/technical.htm>

Or email to support@quectel.com.

General Notes

Quectel offers the information as a service to its customers. The information provided is based upon customers' requirements. Quectel makes every effort to ensure the quality of the information it makes available. Quectel does not make any warranty as to the information contained herein, and does not accept any liability for any injury, loss or damage of any kind incurred by use of or reliance upon the information. All information supplied herein is subject to change without prior notice.

Disclaimer

While Quectel has made efforts to ensure that the functions and features under development are free from errors, it is possible that these functions and features could contain errors, inaccuracies and omissions. Unless otherwise provided by valid agreement, Quectel makes no warranties of any kind, implied or express, with respect to the use of features and functions under development. To the maximum extent permitted by law, Quectel excludes all liability for any loss or damage suffered in connection with the use of the functions and features under development, regardless of whether such loss or damage may have been foreseeable.

Duty of Confidentiality

The Receiving Party shall keep confidential all documentation and information provided by Quectel, except when the specific permission has been granted by Quectel. The Receiving Party shall not access or use Quectel's documentation and information for any purpose except as expressly provided herein. Furthermore, the Receiving Party shall not disclose any of the Quectel's documentation and information to any third party without the prior written consent by Quectel. For any noncompliance to the above requirements, unauthorized use, or other illegal or malicious use of the documentation and information, Quectel will reserve the right to take legal action.

Copyright

The information contained here is proprietary technical information of Quectel. Transmitting, reproducing, disseminating and editing this document as well as using the content without permission are forbidden. Offenders will be held liable for payment of damages. All rights are reserved in the event of a patent grant or registration of a utility model or design.

Copyright © Quectel Wireless Solutions Co., Ltd. 2021. All rights reserved.

About the Document

Revision History

Version	Date	Author	Note
-	2020-12-14	Kenny YIN	Creation of the document
1.0	2020-12-14	Kenny YIN	First official release
2.0	2021-06-09	Aria CHU	Updated all test data in this datasheet.
2.1	2021-06-21	Aria CHU	Updated the efficiency and gain charts in Chapter 4.
2.2	2021-06-28	Aria CHU	Updated the efficiency and gain charts in Chapter 4.
2.3	2021-07-08	Aria CHU	Updated the reference PCB design in Chapter 4.8.

Contents

About the Document	3
Contents	4
1 Product Description.....	5
2 Product Features	5
3 Product Specifications	6
4 Overall Performance.....	7
4.1. Test Environment	7
4.2. Return Loss.....	8
4.3. Efficiency	9
4.4. Gain.....	10
4.5. Radiation Pattern	11
4.6. Schematic Symbol and Pin Definition.....	14
4.7. Transmission Line	14
4.8. Reference PCB Design (Unit: mm).....	15
4.9. Matching Circuit	16
5 Product Size (Unit: mm)	17
6 Dependability Test	18
7 Reflow Profile	19
8 Packaging and Dimensions	19

1 Product Description

The antenna is designed for superior performance, and can be widely used for wireless applications.

We provide comprehensive antenna design support such as simulation, testing and manufacturing for custom antenna solutions to meet your specific application needs.

2 Product Features

- GNSS 1559–1606 MHz
- High efficiency
- Excellent performance

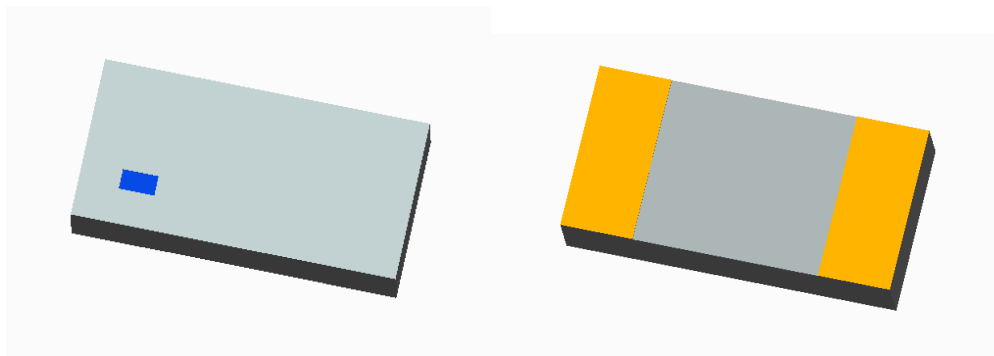

3 Product Specifications

- The antenna is tested on a 50 mm × 90 mm evaluation board.

Passive Electrical Specifications

Frequency Range	1559–1606 MHz
Input Impedence	50 Ω
S11	< -10.2
Gain	> 1.19 dBi
Efficiency	\geq 59 %
Azimuth Beam Width	Omni-directional
Polarization Type	Linear

Mechanical Specifications

Antenna Size	3.2 mm (L) × 1.6 mm (W) × 0.6 mm (H)
Carrier	Ceramic
Connector Type	SMD
Operating Temperature	-40 °C to + 85 °C

4 Overall Performance

4.1. Test Environment

- KEYSIGHT VNA Network Analyzer E5063A 100 kHz – 8.5 GHz
- RayZone® 2800 Chamber 5G (FR1) SISO/MIMO, 400 MHz – 8.0 GHz



4.2. Return Loss

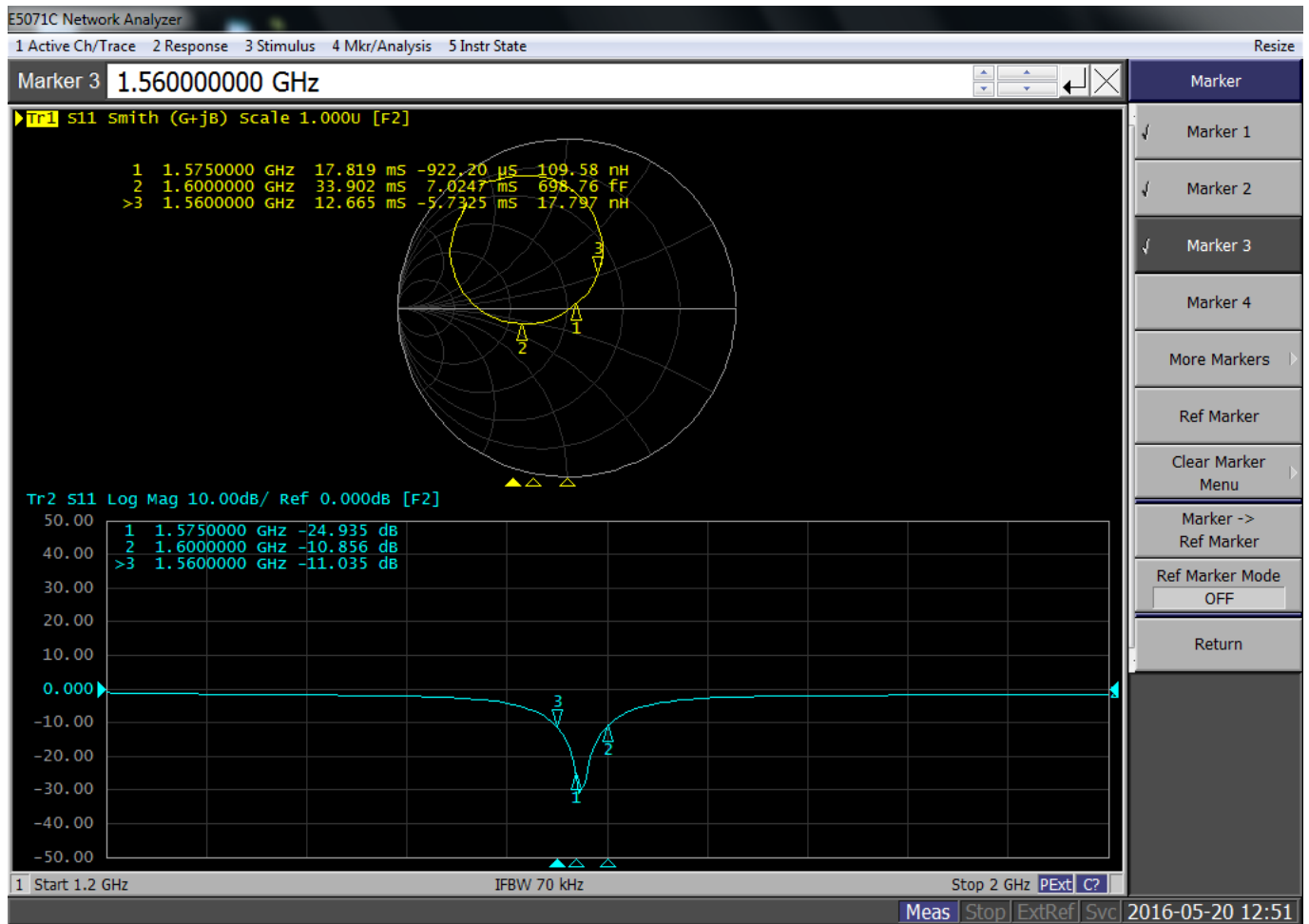

Frequency (MHz)	1561	1575	1602
S11	-12.3	-24.9	-10.2

4.3. Efficiency

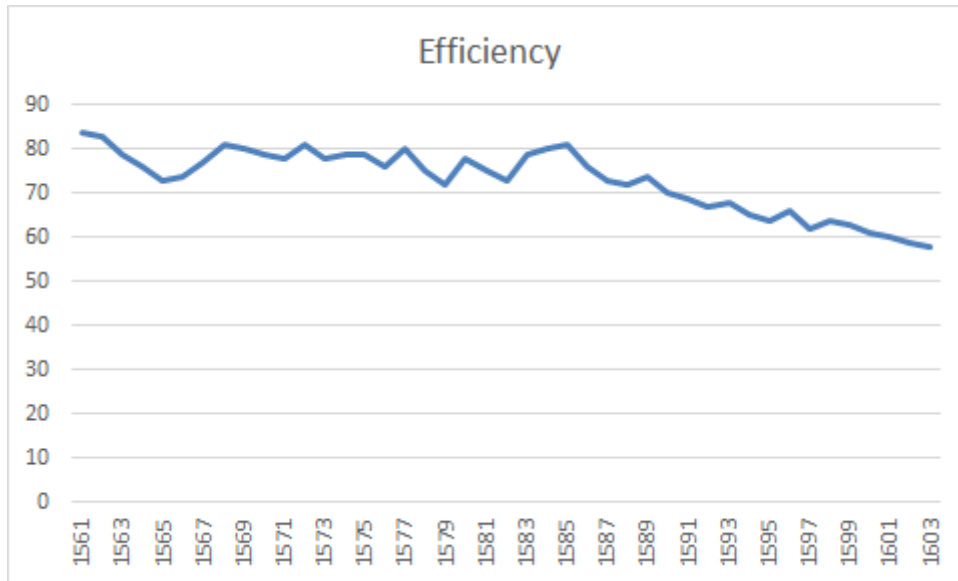

Frequency (MHz)	1561	1575	1602
Efficiency (%)	84	79	59

4.4. Gain

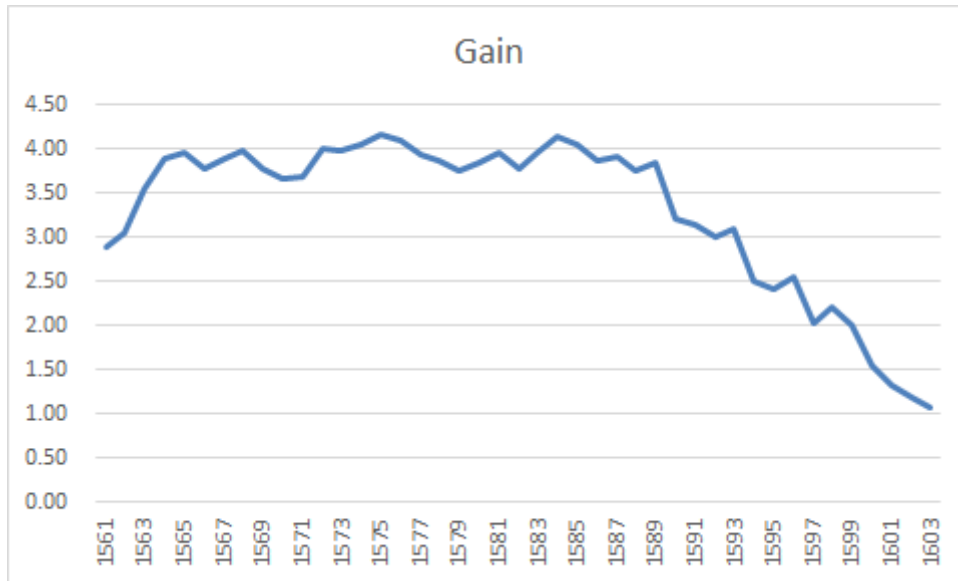

Frequency (MHz)	1561	1575	1602
Gain (dBi)	2.89	4.18	1.19

4.5. Radiation Pattern

- Board length: 90 mm

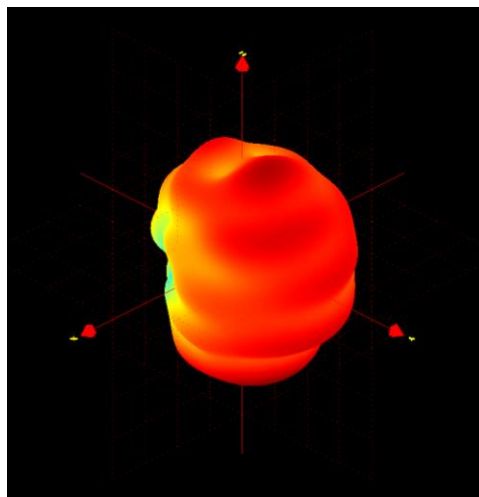
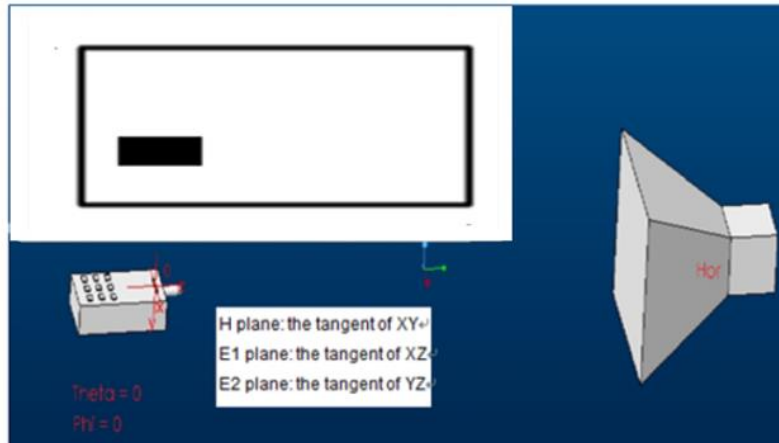

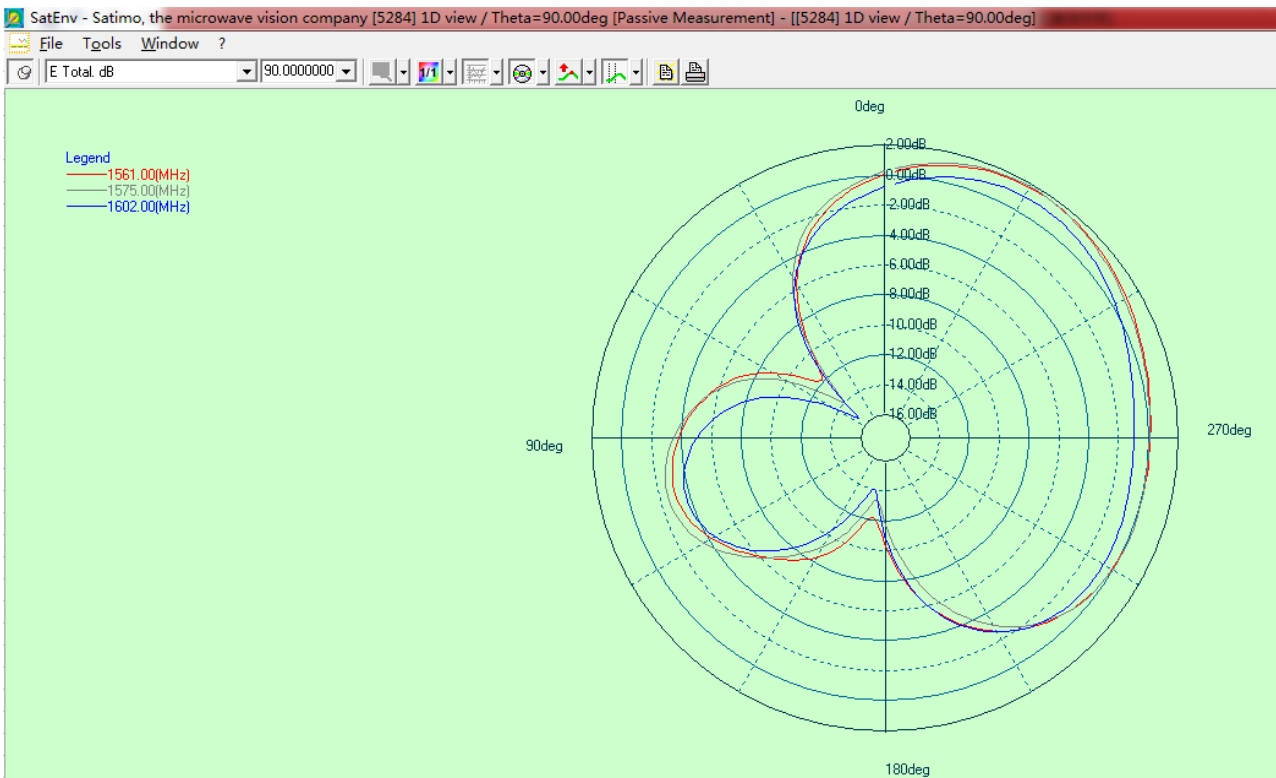
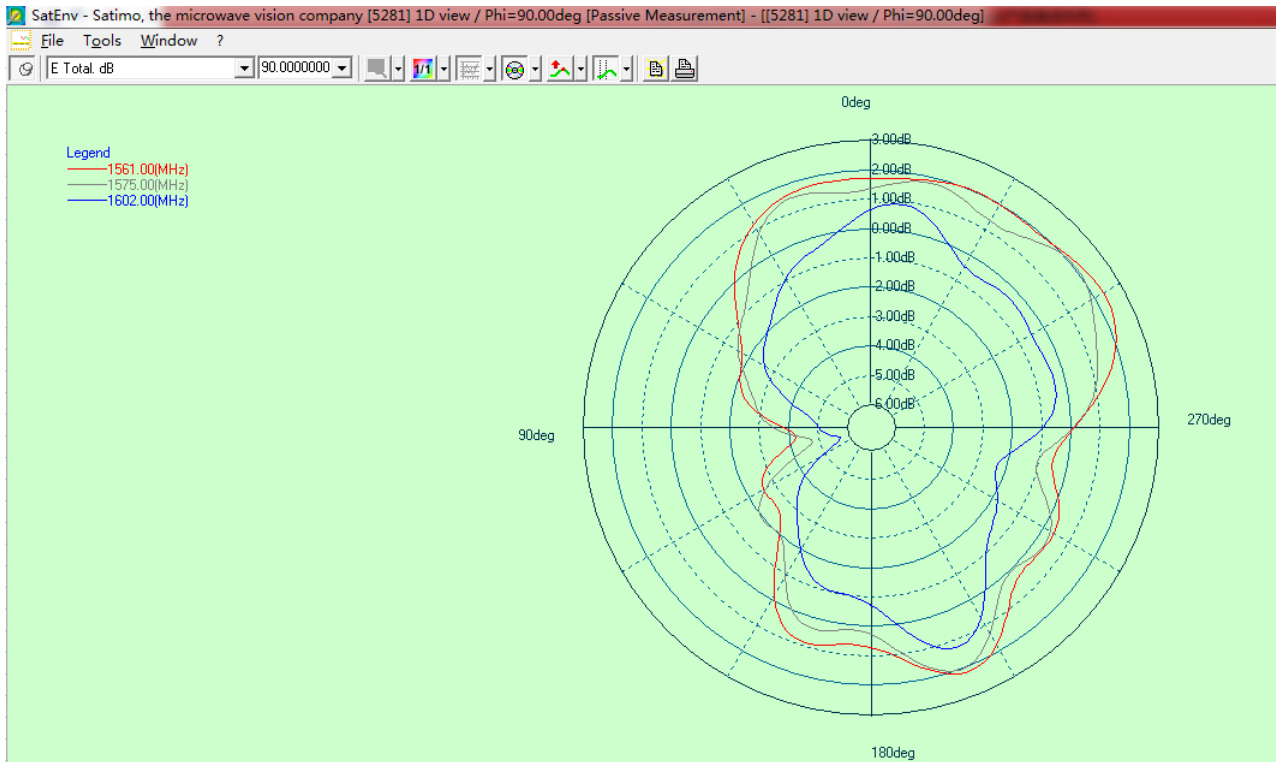

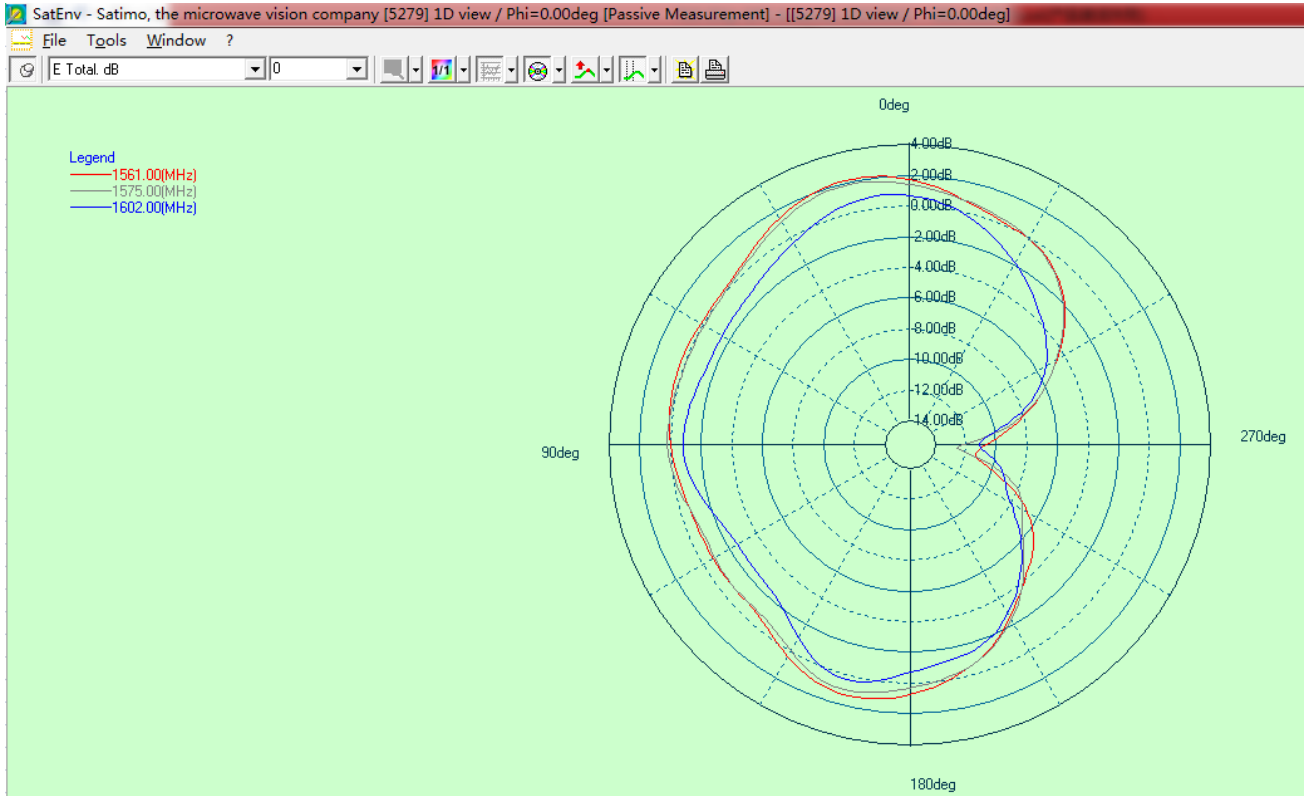

4.6. Schematic Symbol and Pin Definition

The pin assignment for the antenna is as follows. The antenna has 2 pins which both work. All other pins are designed for mechanical strength.



Pin No.	Description
1	Feed (GND)
2	GND (Feed)

4.7. Transmission Line

The characteristic impedance of all transmission lines shall be designed as 50 Ω .

- The length of the transmission lines should be kept as short as possible.
- Any other part of the RF system, such as transceiver, power amplifiers, etc., shall also be designed with an impedance of 50 Ω .

4.8. Reference PCB Design (Unit: mm)

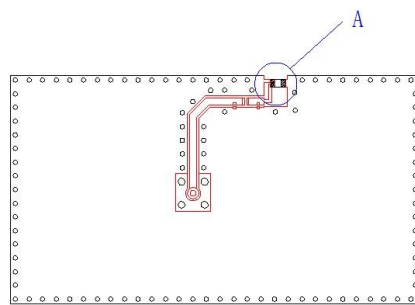
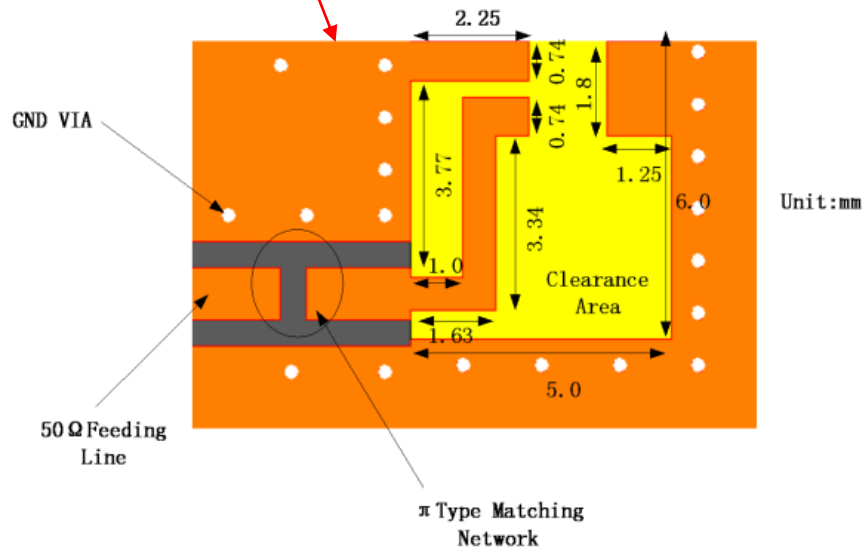
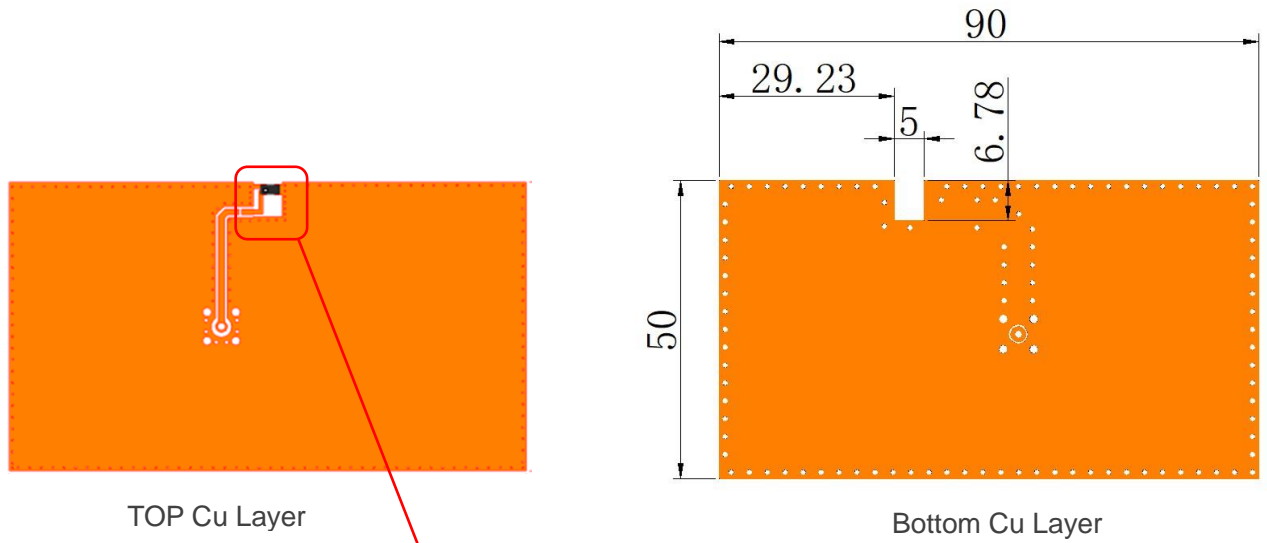

Welding diagram

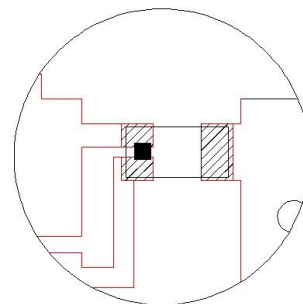

A

SCALE 7:1

4.9. Matching Circuit

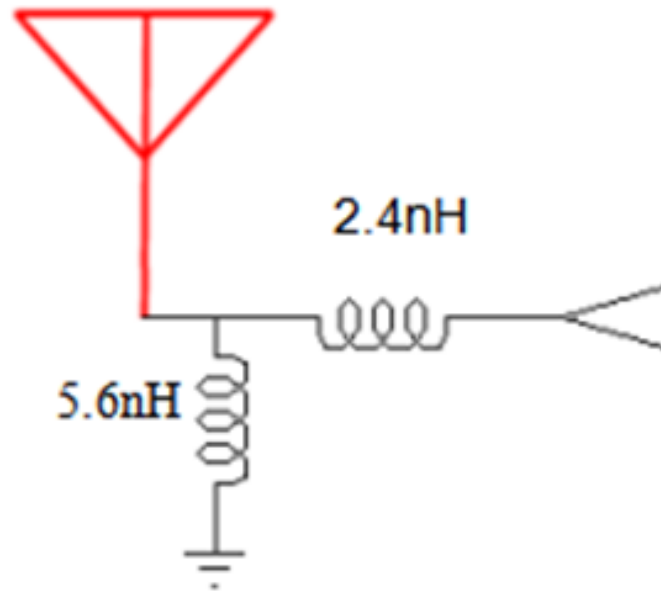

5 Product Size (Unit: mm)

ROHS

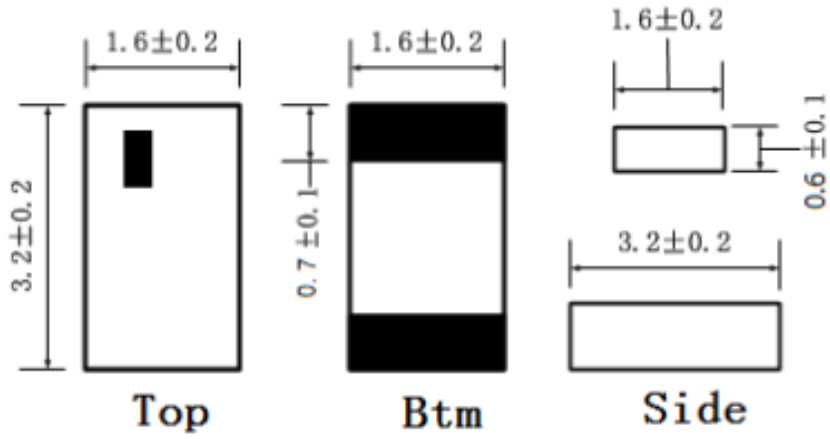

6 Dependability Test

Reference Condition:	Temperature range	$25 \pm 5^{\circ}\text{C}$
	Relative Humidity range	55~75%RH
	Operating Temperature range	$-40^{\circ}\text{C} \sim +85^{\circ}\text{C}$
	Storage Temperature range	$-40^{\circ}\text{C} \sim +85^{\circ}\text{C}$

6.1 Vibration Resist

The device should satisfy the electrical characteristics specified in paragraph 8.1~8.4 after applied to the vibration of 10 to 55Hz with amplitude of 1.5mm for 2 hours each in X, Y and Z directions.

6.2 Drop Shock

The device should satisfy the electrical characteristics specified in paragraph 8.1~8.4 after dropping onto the hard wooden board from the height of 100cm for 3 times each facet of the 3 dimensions of the device.

6.3 Solder Heat Proof

The device should be satisfied after preheating at $120^{\circ}\text{C} \sim 150^{\circ}\text{C}$ for 120 seconds and dipping in soldering Sn at $255^{\circ}\text{C} + 10^{\circ}\text{C}$ for 5 ± 0.5 seconds, or electric iron $300^{\circ}\text{C} - 10^{\circ}\text{C}$ for 3 ± 0.5 seconds, without damnify.

6.4 Adhesive Strength of Termination

The device have no remarkable damage or removal of the termination after horizontal force of 5N(≤ 0603); 10N(>0603)with 10 ± 1 seconds.

6.5 Bending Resist Test

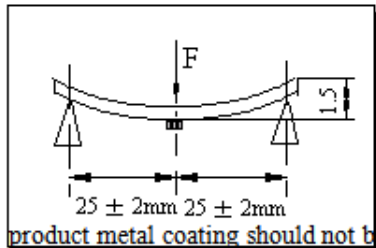

Weld the product to the center part of the PCB with the thickness $1.6 \pm 0.2\text{mm}$ as the illustration shows, and keep exerting force arrow-ward on it at speed of 1mm/S , and hold for $5 \pm 1\text{s}$ at the position of 1.5mm bending distance, so far, any peeling off of the product metal coating should not be detected.

6.6 Moisture Proof

The device should satisfy the electrical characteristics specified in paragraph 8.1~8.4 after exposed to the temperature $60 \pm 2^{\circ}\text{C}$ and the relative humidity 90~95% RH for 96 hours and 1~2 hours recovery time under normal condition.

6.7 High Temperature Endurance

The device should satisfy the electrical characteristics specified in paragraph 8.1~8.4 after exposed to temperature $85 \pm 5^{\circ}\text{C}$ for 96 ± 2 hours and 1~2 hours recovery time under normal temperature.

6.8 Low Temperature Endurance

The device should also satisfy the electrical characteristics specified in paragraph 8.1~8.4 after exposed to the temperature $-40^{\circ}\text{C} \pm 5^{\circ}\text{C}$ for 96 ± 2 hours and to 2 hours recovery time under normal temperature.

6.9 Temperature Cycle Test

The device should also satisfy the electrical characteristics specified in paragraph 8.1~8.4 after exposed to the low temperature -40°C and high temperature $+85^{\circ}\text{C}$ for 30 ± 2 min each by 5 cycles and 1 to 2 hours recovery time under normal temperature.

7 Reflow Profile

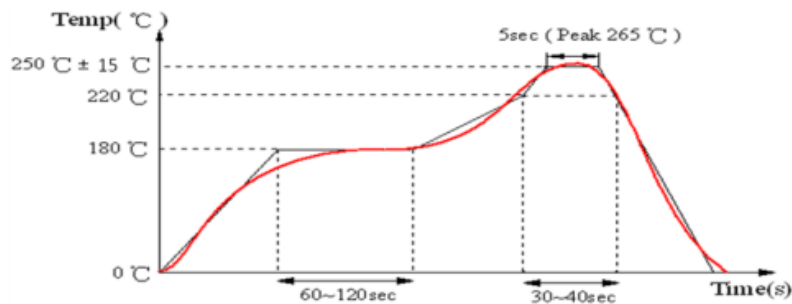

8 Packaging and Dimensions

8.1 Plastic Tape

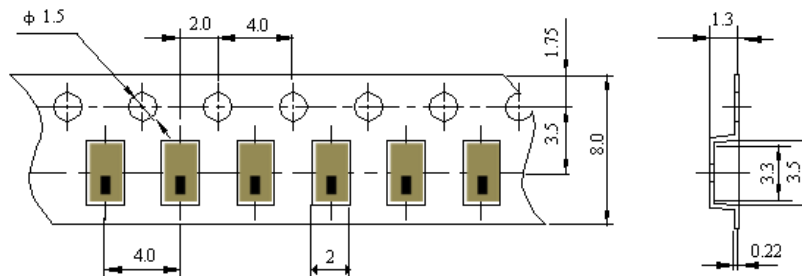

Remarks for Package

Reserve a length of 150~200mm for the trailer of the carrier and 250~300 mm for the leader of the carrier and further 250mm of cover tape at the leading part of the carrier.

8.2 Reel (3000 pcs/Reel)

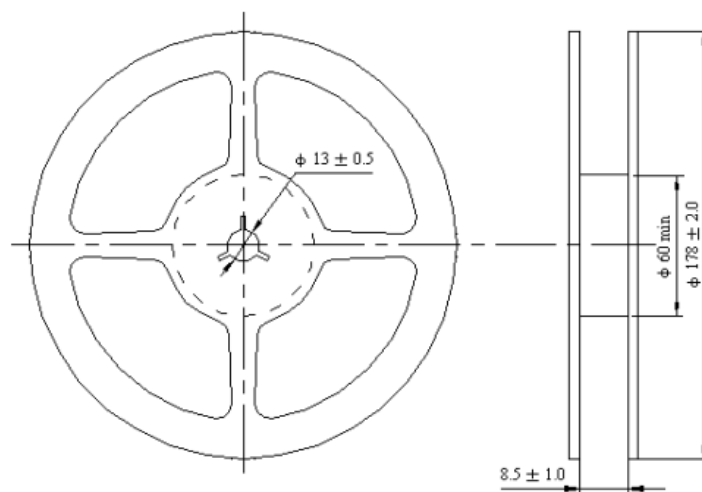

8.3 Storage Period

Product should be used within six months of receipt.

MSL 1 / Storage Temperature Range : <30 degree C, Humidity : <85%RH