

TPS51020 Buck Controller Evaluation Module User's Guide



Table of Contents

1 Introduction	2
2 Electrical Performance Specifications	2
2.1 Performance Specification Summary.....	2
3 TPS51020EVM-001 Circuit Module Schematic	4
4 Test Setup and Results	5
4.1 Test Setup.....	5
4.2 Power Up and Power Down.....	5
4.3 Efficiency and Power Loss.....	6
4.4 Output Ripple.....	6
4.5 Load Transient.....	6
4.6 Loop Characteristics.....	7
5 Assembly Drawing and PCB Layout	8
6 Circuit Module List of Materials	11
7 References	12
8 Revision History	12

Trademarks

All trademarks are the property of their respective owners.

1 Introduction

The TPS51020 is a multi-function dual-synchronous step-down controller. The part is specifically designed for high performance, high-efficiency applications where the loss associated with a current sense resistor is unacceptable. The TPS51020 uses feedforward voltage mode control to improve the line response. Efficiency at light load conditions can be maintained high as well by incorporating auto-skip operation. The TPS51020 can be used in the following:

- Notebook computer system bus and I/O, DDR I, or DDR II termination applications
- Distributed power and point-of-load regulation for DSPs, FPGAs, ASICs, and so forth
- Servers
- Base stations
- Broadband, networking or optical communications systems

The TPS51020EVM-001 evaluation module (EVM) is a high-efficiency, dual synchronous buck converter providing 5 V at 6.0 A and 3.3 V at 6.0 A from an 8.0-V to 20-V input. The TPS51020 operates at 300 kHz with a peak efficiency of 94.8% with both channels enabled. This user's guide describes the TPS51020EVM-001 performance in dual mode.

2 Electrical Performance Specifications

A summary of performance specifications for the TPS51020EVM-001 is provided in [Table 2-1](#).

2.1 Performance Specification Summary

Table 2-1. Performance Specification Summary

SPECIFICATION	TEST CONDITIONS	MIN	TYP	MAX	UNIT
GENERAL					
Input voltage range, V_{IN} (DC)		8	12	20	V
Operating frequency			300		kHz
Input ripple voltage (RMS value)	$V_{IN} = 12\text{ V}$, $I_{OUT1} = 6\text{ A}$, $I_{OUT2} = 6\text{ A}$		194		mV
CHANNEL1(VO1, GND)					
Maximum output current	$8\text{ V} \leq V_{IN} \leq 20\text{ V}$	6			A
Output voltage		4.85	5.00	5.13	V
Line regulation	$I_{OUT1} = 6\text{ A}$, $8\text{ V} \leq V_{IN} \leq 20\text{ V}$			0.1%	
Load regulation	$V_{IN} = 12\text{ V}$, $0\text{ A} \leq I_{OUT1} \leq 6\text{ A}$			0.1%	
Load transient response voltage change	I_{OUT1} rising from 0 A to 5 A		30		mV _{P-P}
	I_{OUT1} falling from 5 A to 0 A		60		
Load transient response recovery time	I_{OUT1} rising from 0 A to 5 A			500	ms
	I_{OUT1} falling from 5 A to 0 A			500	
Loop bandwidth	$I_{OUT1} = 6\text{ A}$, $V_{IN} = 12\text{ V}$		14		kHz
Phase margin	$I_{OUT1} = 6\text{ A}$, $V_{IN} = 12\text{ V}$		32		
Output ripple voltage	$I_{OUT1} = 6\text{ A}$, $V_{IN} = 12\text{ V}$		36	60	mV _{P-P}
Output rise time	$I_{OUT1} = 6\text{ A}$, $V_{IN} = 12\text{ V}$, $VO1 = 5\text{ V}$		4.6		ms
Full load efficiency	$I_{OUT1} = 6\text{ A}$, $VO1 = 5\text{ V}$, $I_{OUT2} = 0\text{ A}$, $V_{IN} = 12\text{ V}$		93.9%		
CHANNEL2(VO2, GND)					
Maximum output current	$8\text{ V} \leq V_{IN} \leq 20\text{ V}$	6			A
Output voltage		3.21	3.30	3.38	V
Line regulation	$I_{OUT2} = 6\text{ A}$, $8\text{ V} \leq V_{IN} \leq 20\text{ V}$			0.1%	
Load regulation	$V_{IN} = 12\text{ V}$, $0\text{ A} \leq I_{OUT2} \leq 6\text{ A}$			0.2%	
Load transient response voltage change	I_{OUT2} rising from 0 A to 5 A		50		mV _{P-P}
	I_{OUT2} falling from 5 A to 0 A		50		
Load transient response recovery time	I_{OUT2} rising from 0 A to 5 A			500	ms
	I_{OUT2} falling from 5 A to 0 A			500	
Loop bandwidth	$I_{OUT2} = 6\text{ A}$, $V_{IN} = 12\text{ V}$		15		kHz

Table 2-1. Performance Specification Summary (continued)

SPECIFICATION	TEST CONDITIONS	MIN	TYP	MAX	UNIT
Phase margin	$I_{OUT2} = 6\text{ A}$, $V_{IN} = 12\text{ V}$		41		
Output ripple voltage	$I_{OUT2} = 6\text{ A}$, $V_{IN} = 12\text{ V}$		34	60	mV _{P-P}
Output rise time	$I_{OUT2} = 6\text{ A}$, $V_{IN} = 12\text{ V}$, $VO2 = 3.3\text{ V}$		4.72		ms
Full load efficiency	$I_{OUT1} = 0\text{ A}$, $VO2 = 3.3\text{ V}$, $I_{OUT2} = 6\text{ A}$, $V_{IN} = 12\text{ V}$		91.3%		

3 TPS51020EVM-001 Circuit Module Schematic

Figure 3-1 shows the TPS51020EVM-001 circuit module schematic diagram.

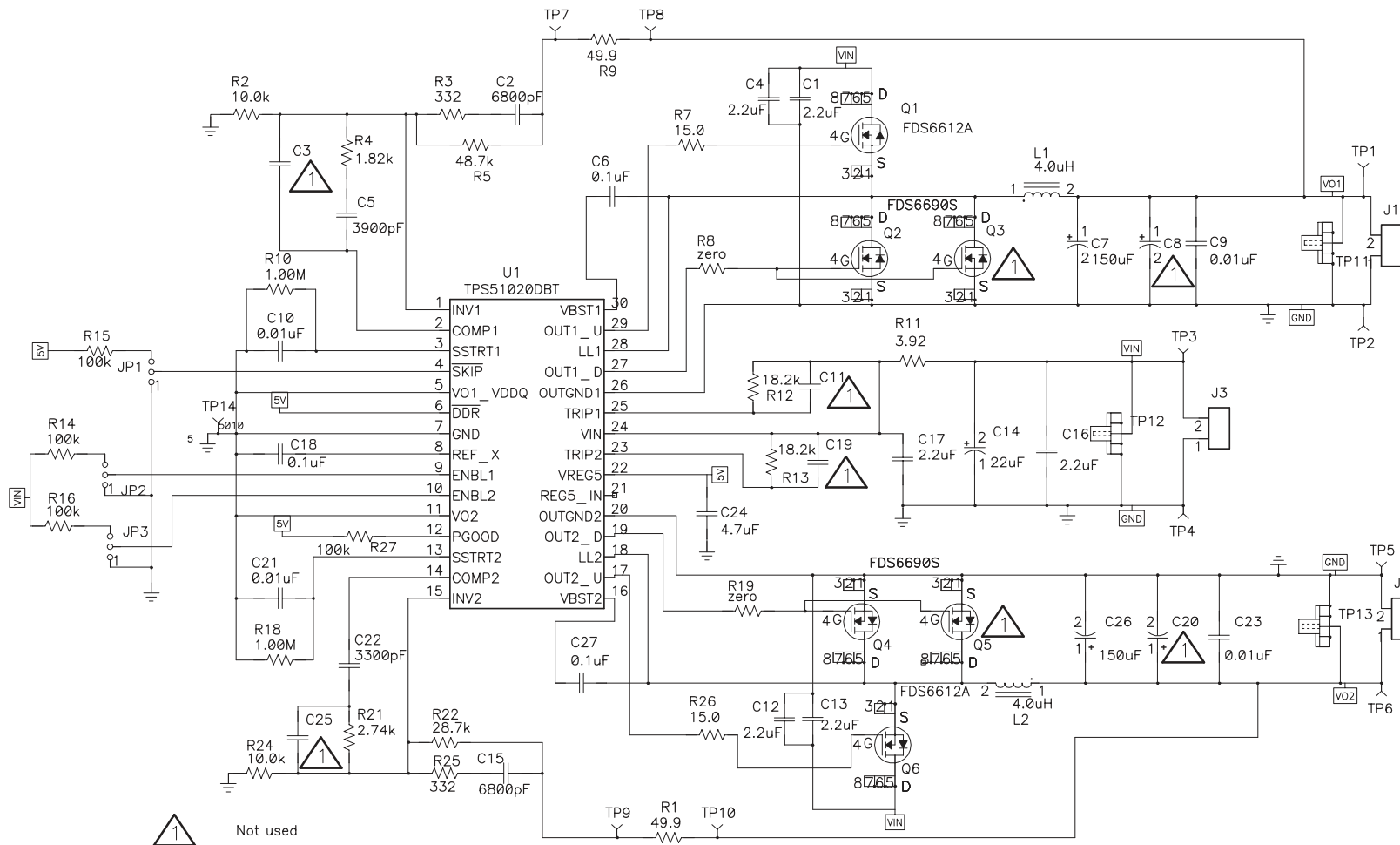

Figure 3-1. TPS51020EVM-001 Schematic

4 Test Setup and Results

4.1 Test Setup

The HPA064 has the following input/output connections: 12-V input through J3 (VIN and GND), 5.0-V output through J1 (VO1 and GND), and 3.3-V output through J2 (VO2 and GND). Figure 4-1 shows the connection points. A power supply capable of supplying 6 A should be connected to VIN and GND through a pair of 16 AWG wires. The 5.0-V and 3.3-V loads should be connected respectively to VO1, GND and VO2, GND2 through pairs of 16 AWG wires. Wire lengths should be minimized to reduce losses in the wires.

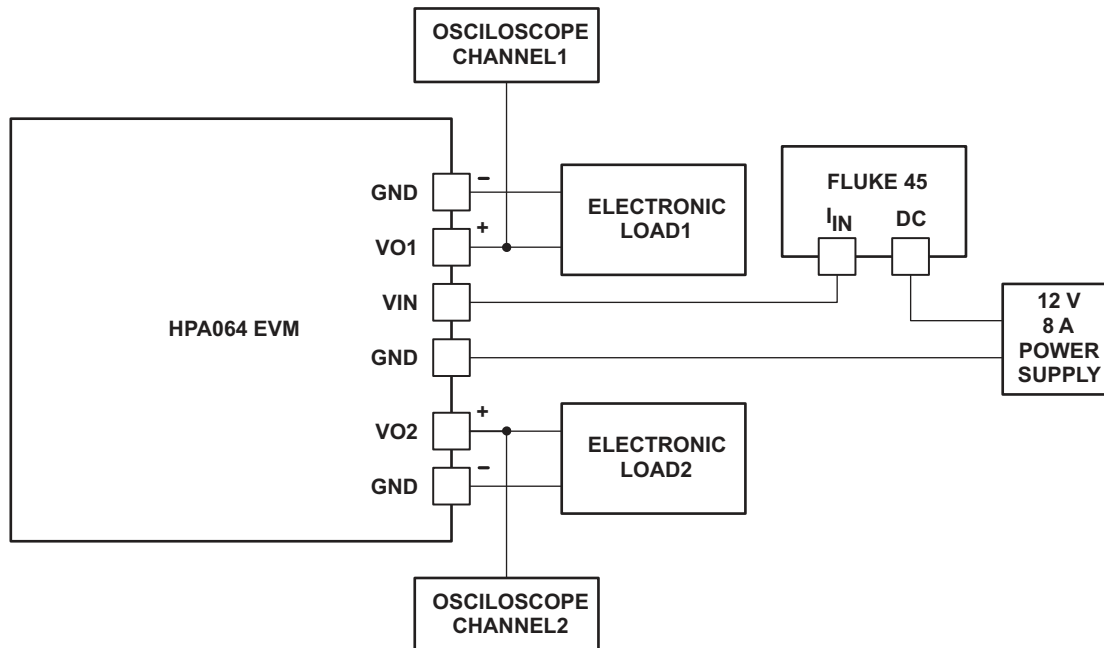

Figure 4-1. TPS51020EVM-001 Schematic

4.2 Power Up and Power Down

Figure 4-2 and Figure 4-3 show the power-up and power-down waveforms. The power good (PGOOD) pin jumps to high after both outputs have started and have been in regulation for 2048 clock pulses (6.8 ms).

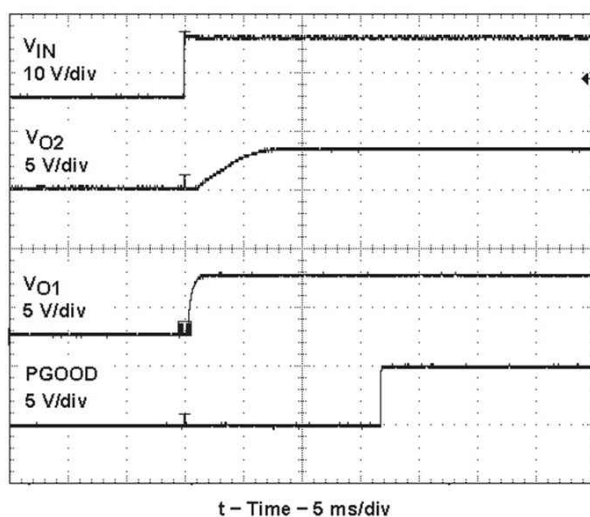

Figure 4-2. Power-Up Waveform

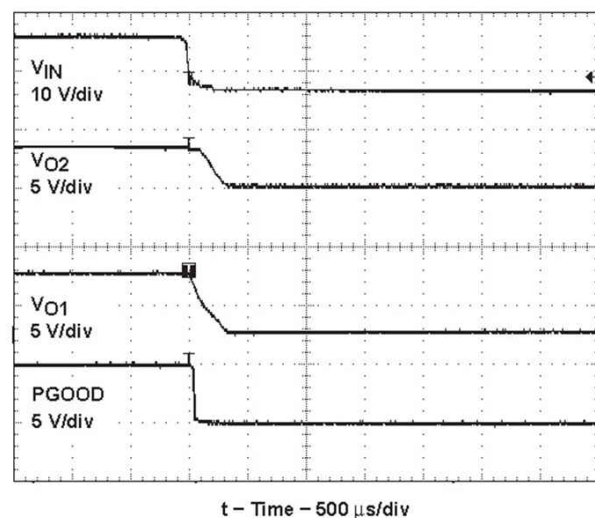

Figure 4-3. Power-Down Waveform

4.3 Efficiency and Power Loss

Figure 4-4 and Figure 4-5 show the test efficiency and power losses versus load current at different conditions. The maximum efficiency is approximately 94.8% when both channels are enabled. The total power loss is 3.5 W when both channels are on and delivering 6.0 A.

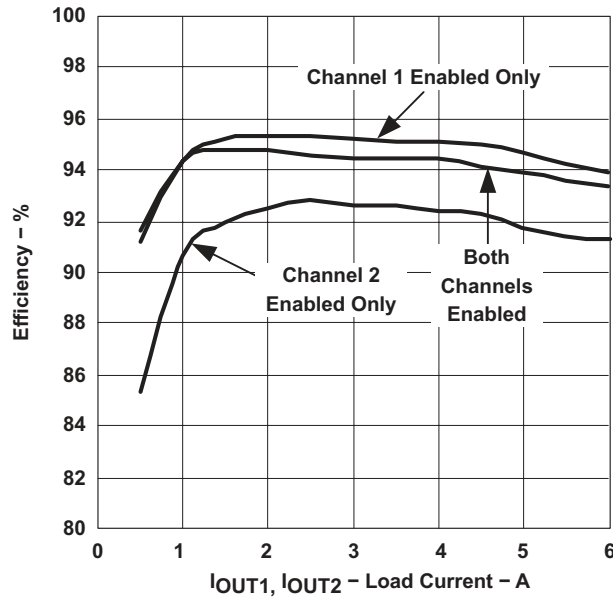

Figure 4-4. Efficiency vs Load Current

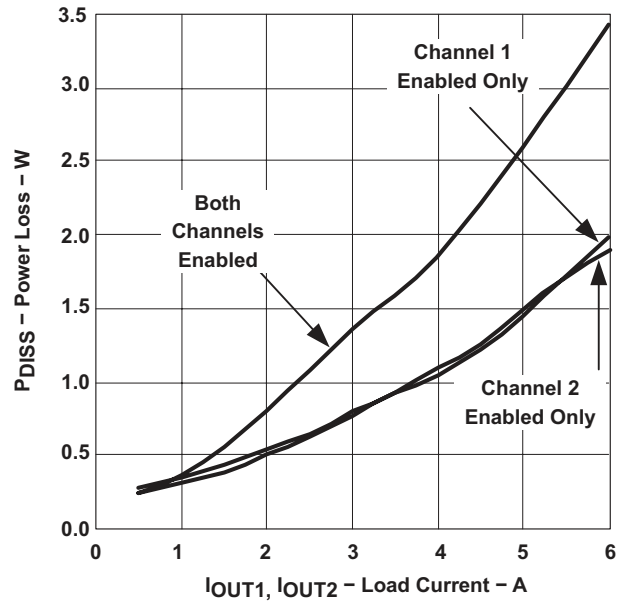

Figure 4-5. Power Loss vs Current

4.4 Output Ripple

In Figure 4-6, the output ripple waveform shows that two channels are running at 180° phase shift. The peak-to-peak ripple voltage is less than 40 mV in each channel.

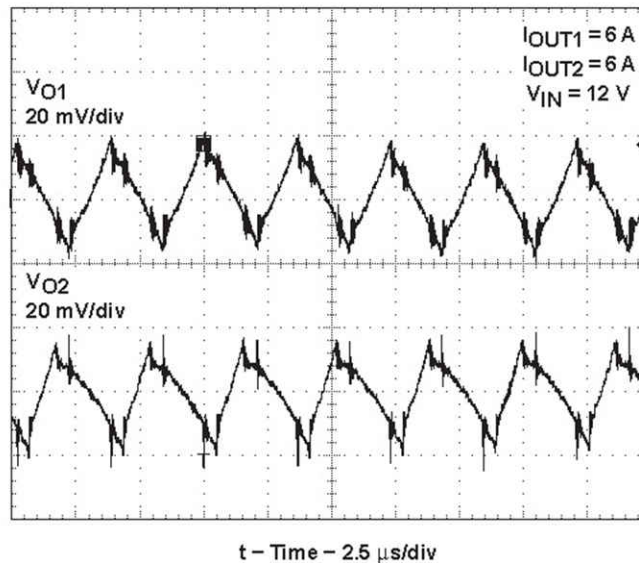

Figure 4-6. Output Ripple

4.5 Load Transient

Figure 4-7 and Figure 4-8 show the load transient waveforms for each channel. When load is stepped from 0 A to 5 A, the undershoot voltage is less than 60 mV and the settling time is less than 30 μ s. When load is stepped down from 5 A to 0 A, the overshoot voltage is less than 50 mV and the settling time is less than 50 μ s.

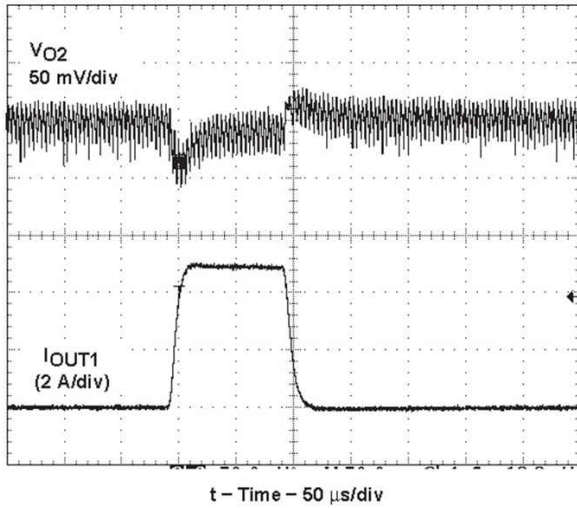

Figure 4-7. Channel 1 Load Transient Waveform

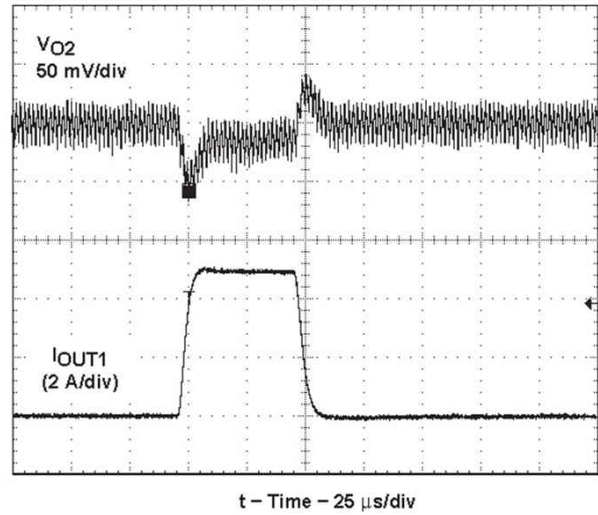

Figure 4-8. Channel 2 Load Transient Waveform

4.6 Loop Characteristics

Figure 4-9 and Figure 4-10 show the bode plot of each channel. The crossover frequency is approximately 14 kHz and the phase margin is 32° for Channel 1 when the output is 5 V and 6 A. Channel 2 shows a 15-kHz crossover frequency and a 41° phase margin.

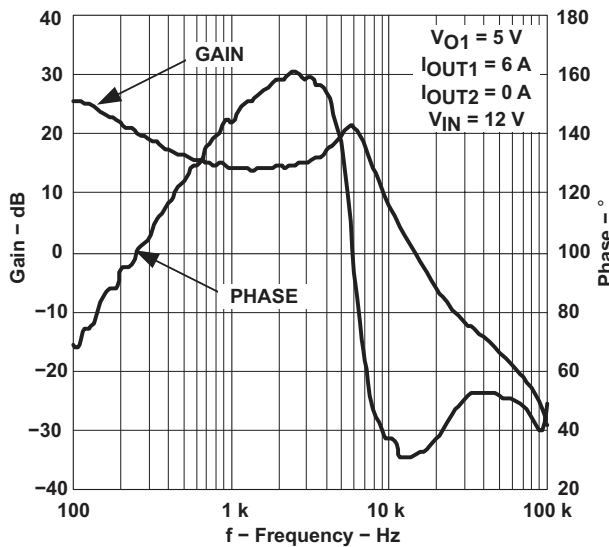

Figure 4-9. Channel 1 Bode Plot

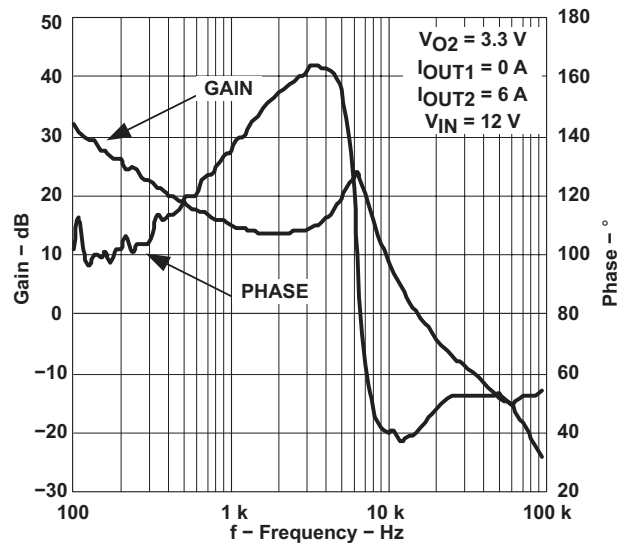

Figure 4-10. Channel 2 Bode Plot

5 Assembly Drawing and PCB Layout

Figure 5-1 through Figure 5-5 show the assembly drawing and each layer.

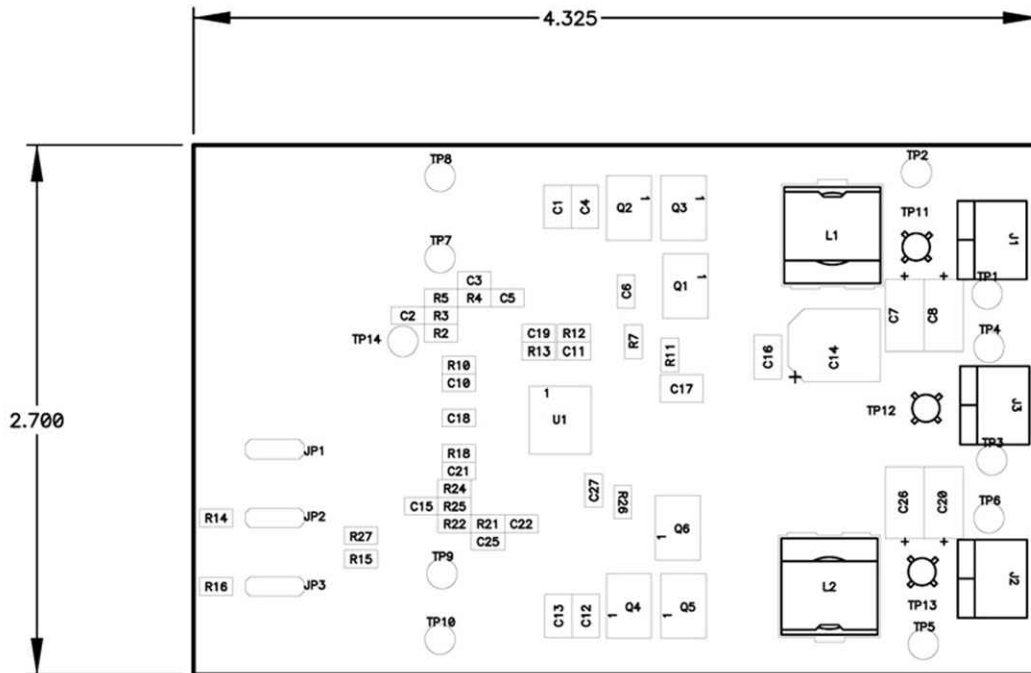

Figure 5-1. Top Assembly

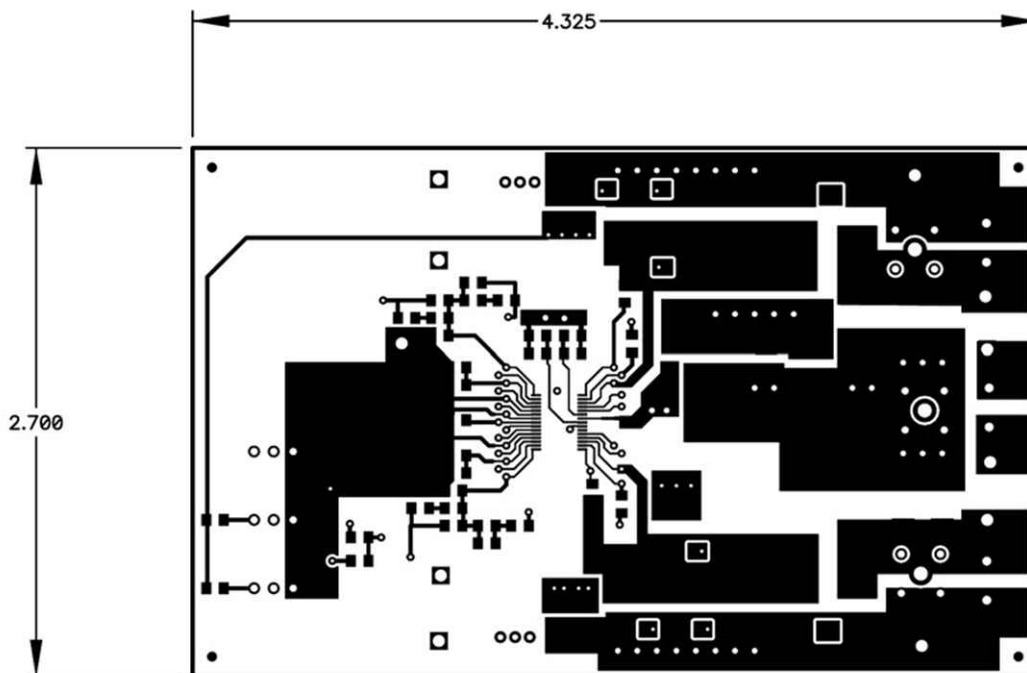

Figure 5-2. Top Layer

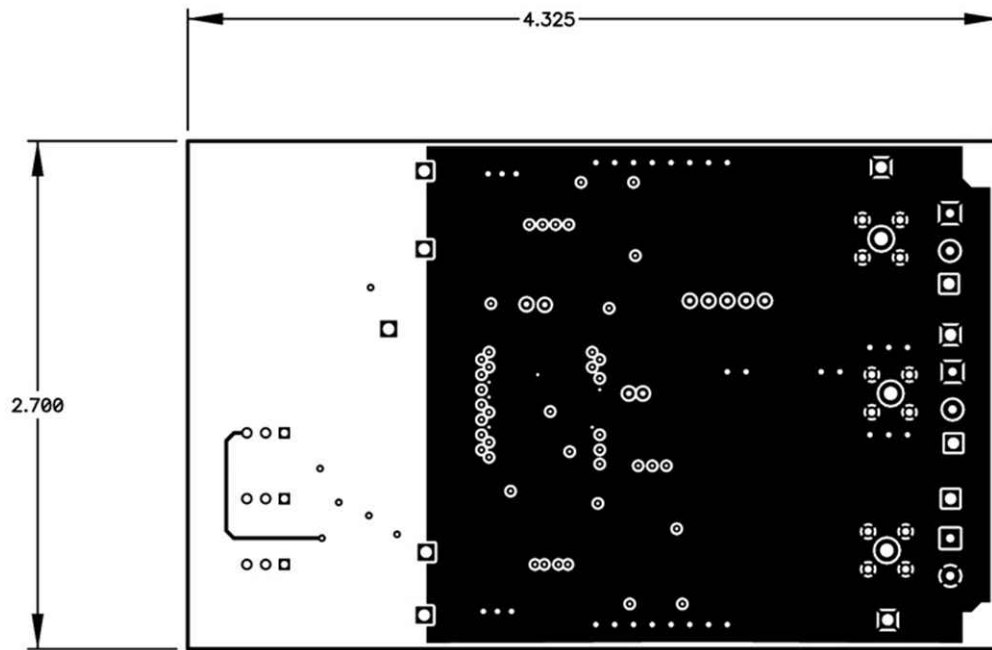

Figure 5-3. Inner Layer 1

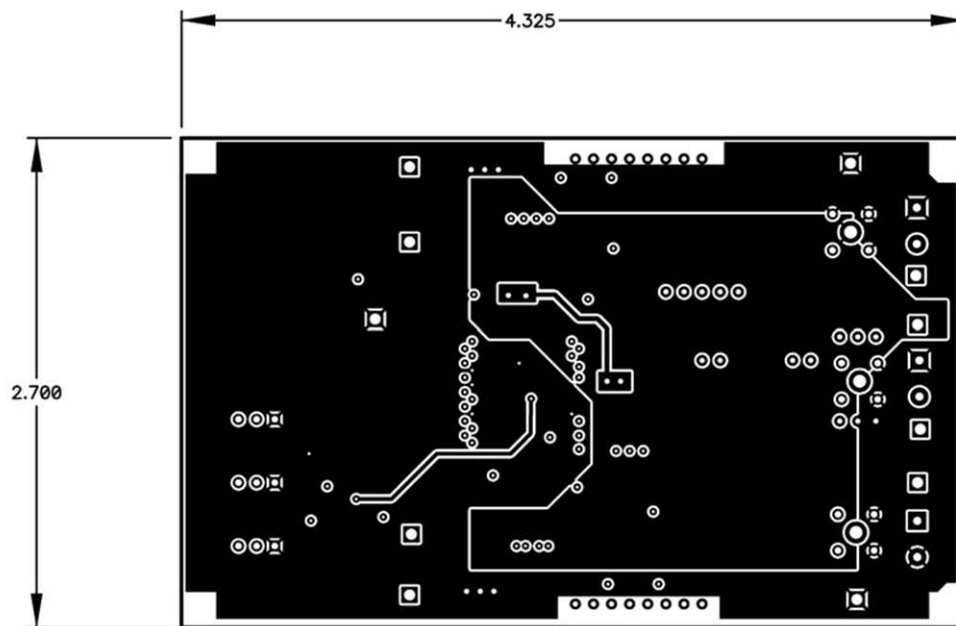

Figure 5-4. Inner Layer 2

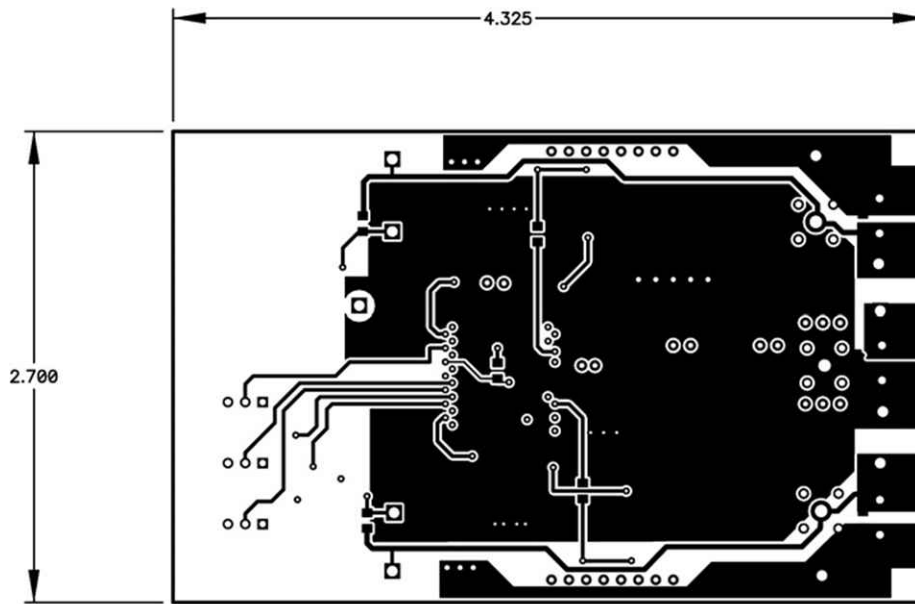

Figure 5-5. Bottom Layer

6 Circuit Module List of Materials

REFERENCE DESIGNATOR	QTY	DESCRIPTION	SIZE	MFR	PART NUMBER
C1, C4, C12, C13, C16, C17	6	Capacitor, ceramic, 2.2 mF, 25 V, X5R, 10%	1210	Panasonic	ECJ-4YB1E225K
C2, C15	2	Capacitor, ceramic, 6800 pF, 25 V, X7R, 10%	805	Std	Std
C3, C11, C19, C25	0	Capacitor, ceramic, TBD	805	Std	Std
C24	1	Capacitor, ceramic, 4.7 mF, 25 V, X5R, 10%	805	Panasonic	ECJ-2FB1E475M
C22	1	Capacitor, ceramic, 3300 pF, 25 V, X7R, 5%	805	Std	Std
C14	1	Capacitor, aluminum solid cap, with conductive polymer 22 mF, 35 V, 20%	8.3m (E7)	Sanyo	35SVPD22M
C5	1	Capacitor, ceramic, 3900 pF, 25 V, X7R, 5%	805	Std	Std
C6, C18, C27	3	Capacitor, ceramic, 0.1 mF, 25 V, X7R, 10%	805	Std	Std
C7, C26	2	Capacitor, aluminum, 150 mF, 6.3 V, 20% (UE Series)	7343	Panasonic	EEF-UE0J151R
C8, C20	0	Capacitor, aluminum, 150 mF, 6.3 V, 20% (UE Series)	7343	Panasonic	EEF-UE0J151R
C9, C10, C21, C23	4	Capacitor, ceramic, 0.01 mF, 25 V, X7R, 10%	805	Std	Std
L1, L2	2	Inductor, SMT, 4.0 mH, 10.3 A, 8.0 mW	0.492 sq"	Sumida	CEP125(H)-4R0
Shorts Jumper	3	STC02SYAN	Shorts Jumper	Sullins	N/A
JP, JP2, JP3	3	Header, 3 pin, 100-mil spacing (36-pin strip)	0.100" 3	Sullins	PTC36SAAN
R1, R9	2	Resistor, chip, 49.9 W, 1/10-W, 1%	805	Vishay	Std
R10, R18	2	Resistor, chip, 1M W, 1/10W, 1%	805	Vishay	Std
R4	1	Resistor, chip, 1.82 kW, 1/10W, 1%	805	Vishay	Std
R21	1	Resistor, chip, 2.74 kW, 1/10W, 1%	805	Vishay	Std
R11	1	Resistor, chip, 3.92 kW, 1/10W, 1%	805	Vishay	Std
R2, R24	2	Resistor, chip, 10.0 kW, 1/10W, 1%	805	Vishay	Std
R7, R26	2	Resistor, chip, 15 W, 1/10W, 1%	805	Vishay	Std
R12, R13	2	Resistor, chip, 18.2 kW, 1/10W, 1%	805	Vishay	Std
R22	1	Resistor, chip, 28.7 kW, 1/10W, 1%	805	Vishay	Std
R5	1	Resistor, chip, 48.7 kW, 1/10W, 1%	805	Vishay	Std
R14, R15, R16, R27	4	Resistor, chip, 100 kW, 1/10W, 1%	805	Vishay	Std
R3, R25	2	Resistor, chip, 332 W, 1/10W, 1%	805	Vishay	Std
R8, R19	2	Resistor, chip, 0 W, 1/10W, 1%	805	Vishay	Std
J1, J2, J3	3	Terminal block, 2 pin, 15 A, 5.1 mm	0.40" 0.35	OST	ED1609
TP1, TP3, TP6, TP8, TP10	5	Test point, 0.062 hole, red	0.25	Keystone	5011
TP2, TP4, TP5, TP7, TP9, TP14	6	Test point, 0.062 hole, black	0.25	Keystone	5010
U1	1	Dual voltage mode, DDR selectable, synchronous, step-down controller for notebook	TSSOP30	TI	TPS51020DBT
TP11, T12, TP13	3	Adaptor, 3.5-mm probe clip (or 131-5031-00)	0.2	Tektronix	131-4244-00
Q1, Q6	2	Transistor, MOSFET, N-channel, 30 V, 8.4 A, Rds 22 mW	SO-8	Fairchild	FDS6612A
Q2, Q4	2	Transistor, MOSFET, N-channel, 30 V, 10 A, Rds 16 mW	SO-8	Fairchild	FDS6690S
Q3, Q5	0	Transistor, MOSFET, N-channel, 30 V, 10 A, Rds 16 mW	SO-8	Fairchild	FDS6690S

7 References

Texas Instruments, [TPS51020 Dual, Voltage Mode, DDR Selectable, Synchronous, Step-down Controller for Notebook System](#)

8 Revision History

NOTE: Page numbers for previous revisions may differ from page numbers in the current version.

Changes from Revision * (May 2004) to Revision A (March 2022)	Page
• Updated the numbering format for tables, figures, and cross-references throughout the document.	2
• Updated the user's guide title.....	2

IMPORTANT NOTICE AND DISCLAIMER

TI PROVIDES TECHNICAL AND RELIABILITY DATA (INCLUDING DATA SHEETS), DESIGN RESOURCES (INCLUDING REFERENCE DESIGNS), APPLICATION OR OTHER DESIGN ADVICE, WEB TOOLS, SAFETY INFORMATION, AND OTHER RESOURCES "AS IS" AND WITH ALL FAULTS, AND DISCLAIMS ALL WARRANTIES, EXPRESS AND IMPLIED, INCLUDING WITHOUT LIMITATION ANY IMPLIED WARRANTIES OF MERCHANTABILITY, FITNESS FOR A PARTICULAR PURPOSE OR NON-INFRINGEMENT OF THIRD PARTY INTELLECTUAL PROPERTY RIGHTS.

These resources are intended for skilled developers designing with TI products. You are solely responsible for (1) selecting the appropriate TI products for your application, (2) designing, validating and testing your application, and (3) ensuring your application meets applicable standards, and any other safety, security, regulatory or other requirements.

These resources are subject to change without notice. TI grants you permission to use these resources only for development of an application that uses the TI products described in the resource. Other reproduction and display of these resources is prohibited. No license is granted to any other TI intellectual property right or to any third party intellectual property right. TI disclaims responsibility for, and you will fully indemnify TI and its representatives against, any claims, damages, costs, losses, and liabilities arising out of your use of these resources.

TI's products are provided subject to [TI's Terms of Sale](#) or other applicable terms available either on ti.com or provided in conjunction with such TI products. TI's provision of these resources does not expand or otherwise alter TI's applicable warranties or warranty disclaimers for TI products.

TI objects to and rejects any additional or different terms you may have proposed.

Mailing Address: Texas Instruments, Post Office Box 655303, Dallas, Texas 75265
Copyright © 2022, Texas Instruments Incorporated