

3950X SERIES
3.50mm HEADERS

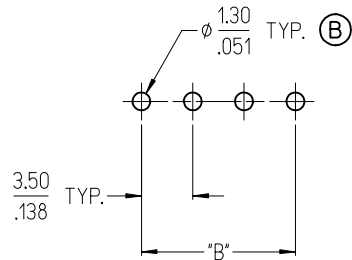

3952X & 3954X SERIES
5.00mm HEADERS
5.00mm FIXED

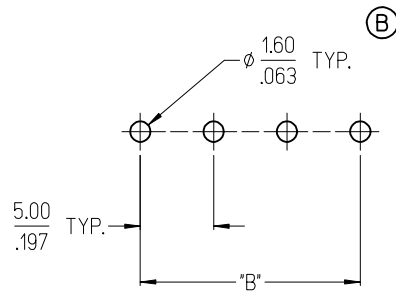

3953X SERIES
5.08mm HEADERS

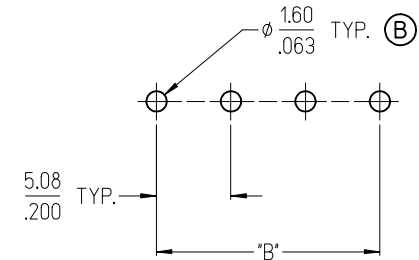

3951X SERIES
3.81mm HEADERS

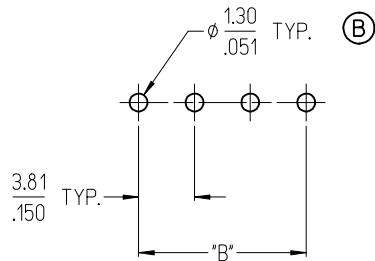

3954X SERIES
5.00mm FIXED

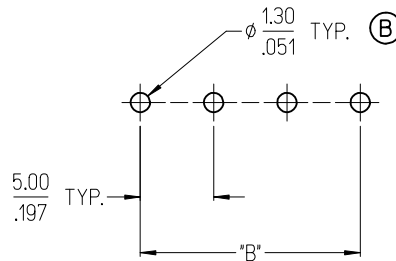

3954X SERIES
5.08mm FIXED

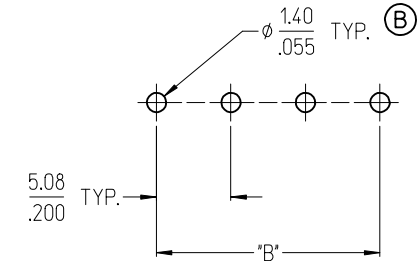

NOTES:

- REFER TO INDIVIDUAL PRODUCT SALES DRAWINGS FOR "B" DIMENSION.
- DOES NOT APPLY TO DUAL LEVEL HEADERS, SERIES 39528 AND 39538.
- TYP. = TYPICAL.

TOLERANCES			
MM	TOL	INCH	TOL
0-6	±0.25	0-.24	±.010
>6-30	±0.40	.24-1.18	±.016
>30-120	±0.50	1.18-4.76	±.020
>120	±0.80	>4.76	±.031

REVISED DOC TOL
EC NO: IPG2017-0881
DRAWN: VASUTHKARP 2017/03/23
CHKD:
APPR: BRUPERT 2017/04/18
REV DESCRIPTION

QUALITY SYMBOLS
▽=0
▽=0

GENERAL TOLERANCES (UNLESS SPECIFIED)

	mm	INCH
4 PLACES	±---	±---
3 PLACES	±---	±---
2 PLACES	±---	±---
1 PLACE	±---	±---
ANGULAR ±---°		

DRAFT WHERE APPLICABLE
MUST REMAIN
WITHIN DIMENSIONS

DIMENSION STYLE
MM/IN

DRAWN BY	DATE
C. YORK	2006/08/25
CHECKED BY	DATE
J. MACNEIL	2006/08/25
APPROVED BY	DATE
J. MACNEIL	2006/08/25

MATERIAL NO. --

SCALE DESIGN UNITS INCH

THIRD ANGLE PROJECTION

RECOMMENDED PCB LAYOUT FOR ESE TERMINAL BLOCKS

molex MOLEX INCORPORATED

DOCUMENT NO. SD-39501-002

SHEET NO. 1 OF 1

THIS DRAWING CONTAINS INFORMATION THAT IS PROPRIETARY TO MOLEX INCORPORATED AND SHOULD NOT BE USED WITHOUT WRITTEN PERMISSION

3950X SERIES
3.50mm HEADERS

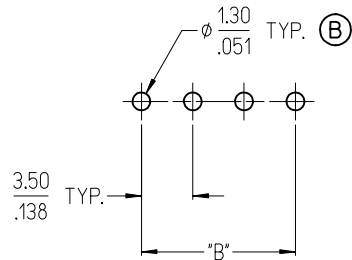

3952X & 3954X SERIES
5.00mm HEADERS
5.00mm FIXED

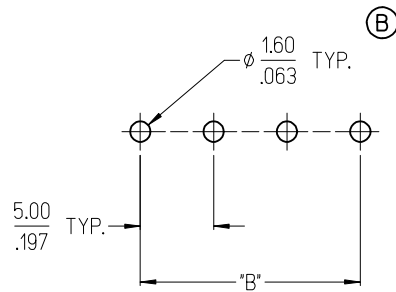

3953X SERIES
5.08mm HEADERS

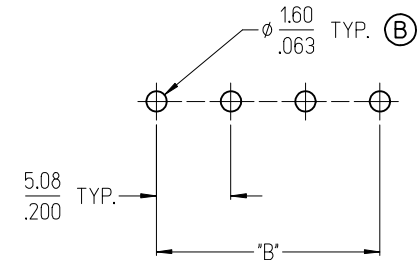

3951X SERIES
3.81mm HEADERS

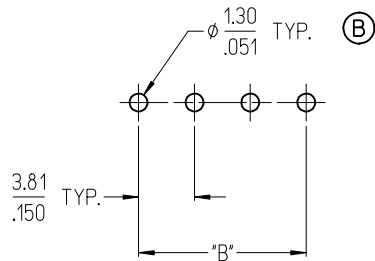

3954X SERIES
5.00mm FIXED

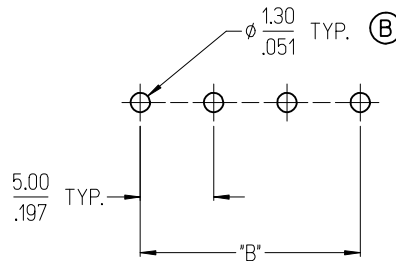

3954X SERIES
5.08mm FIXED

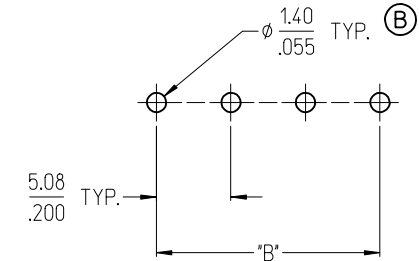

NOTES:

- REFER TO INDIVIDUAL PRODUCT SALES DRAWINGS FOR "B" DIMENSION.
- DOES NOT APPLY TO DUAL LEVEL HEADERS, SERIES 39528 AND 39538.
- TYP. = TYPICAL.

TOLERANCES			
MM	TOL	INCH	TOL
0-6	±0.25	0-.24	±.010
>6-30	±0.40	.24-1.18	±.016
>30-120	±0.50	1.18-4.76	±.020
>120	±0.80	>4.76	±.031

REVISED DOC TOL
EC NO: IPG2017-0881
DRAWN: VASUTHKARP 2017/03/23
CHKD:
APPR: BRUPERT 2017/04/18
REV DESCRIPTION

QUALITY SYMBOLS
▽=0
▽=0

GENERAL TOLERANCES (UNLESS SPECIFIED)

	mm	INCH
4 PLACES	±---	±---
3 PLACES	±---	±---
2 PLACES	±---	±---
1 PLACE	±---	±---
ANGULAR ±---°		

DRAFT WHERE APPLICABLE
MUST REMAIN
WITHIN DIMENSIONS

DIMENSION STYLE
MM/IN

DRAWN BY	DATE
C. YORK	2006/08/25
CHECKED BY	DATE
J. MACNEIL	2006/08/25
APPROVED BY	DATE
J. MACNEIL	2006/08/25

MATERIAL NO. --

SCALE DESIGN UNITS INCH

THIRD ANGLE PROJECTION

RECOMMENDED PCB LAYOUT FOR ESE TERMINAL BLOCKS

molex MOLEX INCORPORATED

DOCUMENT NO. SD-39501-002

SHEET NO. 1 OF 1

THIS DRAWING CONTAINS INFORMATION THAT IS PROPRIETARY TO MOLEX INCORPORATED AND SHOULD NOT BE USED WITHOUT WRITTEN PERMISSION

9 8 7 6 5 4 3 2 1

E
D
C
B
A

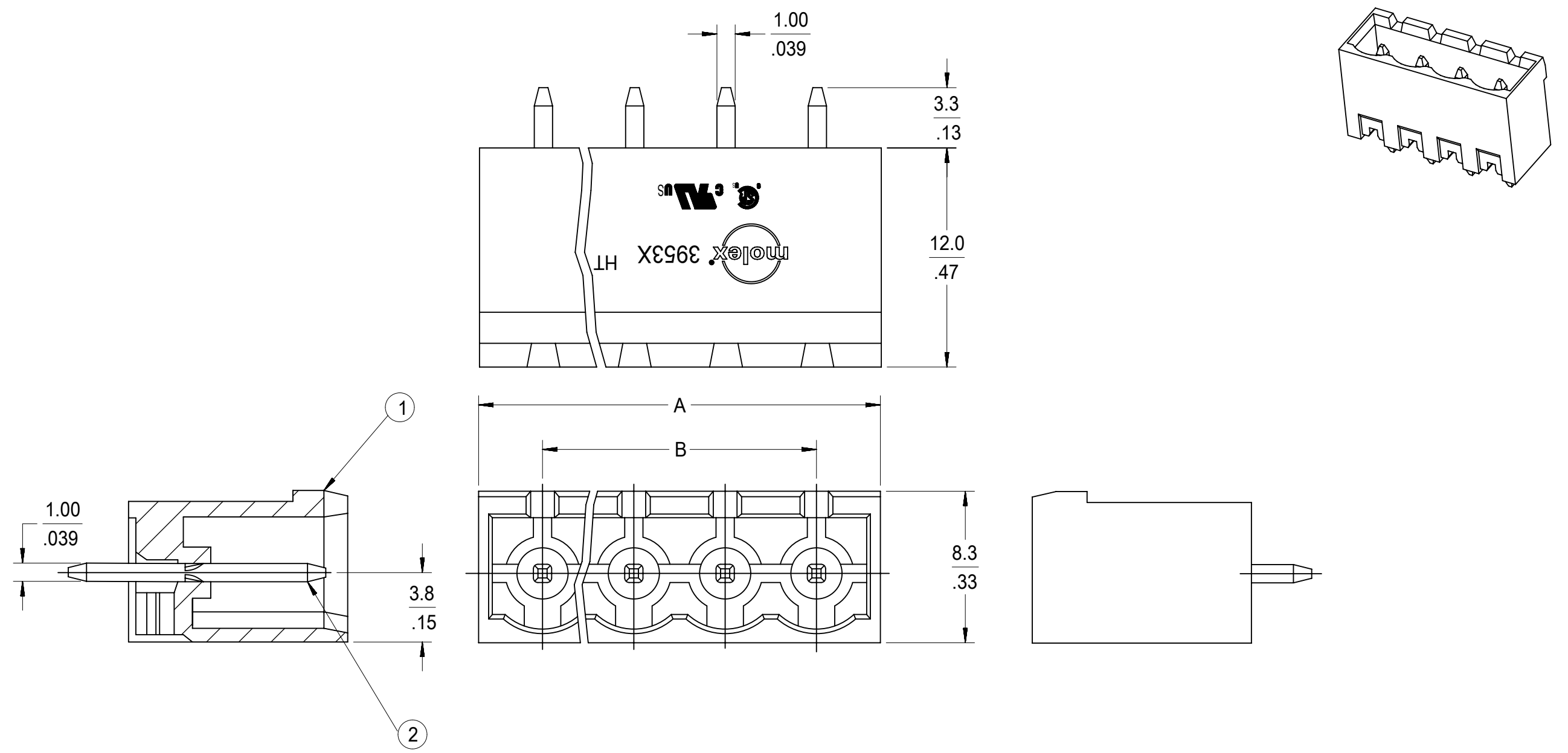

- SPECIFICATIONS:**
- Material:
 - Body: PA46
 - Pin: Brass
 - Wire range: N/A
 - Electrical rating: 300V, 15A.
 - Wire strip length: N/A
 - Operating temperature: -40C to +140C.
 - Max torque: N/A
 - Insulation resistance: DC 500V, 500M.
 - Dielectric withstand: AC 2500V for 1 minute.
 - Breakdown voltage: 4000V.
 - A = (N x P) + 2.0mm
 - B = (N - 1) x P
 - P (PITCH) = 5.08mm (.200").
 - N = Number of positions available 2 through 24.

TOLERANCES			
MM	TOL	INCH	TOL
0-6	±0.25	0-.24	±.010
>6-30	±0.40	.24-1.18	±.016
>30-120	±0.50	1.18-4.76	±.020
>120	±0.80	>4.76	±.031

SYMBOLS		THIS DRAWING CONTAINS INFORMATION THAT IS PROPRIETARY TO MOLEX ELECTRONIC TECHNOLOGIES, LLC AND SHOULD NOT BE USED WITHOUT WRITTEN PERMISSION				
▽ = 0	DIMENSION UNITS	SCALE		CURRENT REV DESC: SEE SHEET 2		
▽ = 0	MM[INCH]	4:1		<p>molex</p> <p>5.08MM, EURO HEADER, VERTICAL, HI-TEMP</p> <p>PRODUCT CUSTOMER DRAWING</p> <p>EC NO: 175526 DRWN: ABENJAMINLW 2018/04/13 CHK'D: BRUPERT 2018/04/24 APPR: BRUPERT 2018/04/25</p> <p>INITIAL REVISION: DRWN: LROTHAUS 2005/12/06 APPR:</p>		
▽ = 0	GENERAL TOLERANCES (UNLESS SPECIFIED)					
▽ = 0		MM	INCH			
▽ = 0	4 PLACES	±	---			±
▽ = 0	3 PLACES	±	---			±
▽ = 0	2 PLACES	±	---	±		
▽ = 0	1 PLACE	±	---	±		
▽ = 0	0 PLACES	±	---	±		
▽ = 0	ANGULAR TOL		±	---	°	
▽ = 0	DRAFT WHERE APPLICABLE MUST REMAIN WITHIN DIMENSIONS		THIRD ANGLE PROJECTION	DRAWING	SERIES	
			⊕	B-SIZE	39531	
	DOCUMENT NUMBER	DOC TYPE	DOC PART	REVISION		
	SD-39531-001	PSD	001	A2		
	MATERIAL NUMBER	CUSTOMER	SHEET NUMBER			
	SEE CHART	GENERAL MARKET	1 OF 2			

9 8 7 6 5 4 3 2 1

Description	Circuit size	Material Numbers						Dimensional Information							
		Black						Dim. A				Dim B			
		100% Tin			30 u" Gold										
		Printing Options			Printing Options			mm		inch		mm		inch	
None	10AV	11AV	None	10AV	11AV										
5.08mm, Euro Header, Vertical, High Temp	2	395314002	395314302	395314402	395314502	395314802	395314902	12.16	0.479	5.08	0.200				
5.08mm, Euro Header, Vertical, High Temp	3	395314003	395314303	395314403	395314503	395314803	395314903	17.24	0.679	10.16	0.400				
5.08mm, Euro Header, Vertical, High Temp	4	395314004	395314304	395314404	395314504	395314804	395314904	22.32	0.879	15.24	0.600				
5.08mm, Euro Header, Vertical, High Temp	5	395314005	395314305	395314405	395314505	395314805	395314905	27.40	1.079	20.32	0.800				
5.08mm, Euro Header, Vertical, High Temp	6	395314006	395314306	395314406	395314506	395314806	395314906	32.48	1.279	25.40	1.000				
5.08mm, Euro Header, Vertical, High Temp	7	395314007	395314307	395314407	395314507	395314807	395314907	37.56	1.479	30.48	1.200				
5.08mm, Euro Header, Vertical, High Temp	8	395314008	395314308	395314408	395314508	395314808	395314908	42.64	1.679	35.56	1.400				
5.08mm, Euro Header, Vertical, High Temp	9	395314009	395314309	395314409	395314509	395314809	395314909	47.72	1.879	40.64	1.600				
5.08mm, Euro Header, Vertical, High Temp	10	395314010	395314310	395314410	395314510	395314810	395314910	52.80	2.079	45.72	1.800				
5.08mm, Euro Header, Vertical, High Temp	11	395314011	395314311	395314411	395314511	395314811	395314911	57.88	2.279	50.80	2.000				
5.08mm, Euro Header, Vertical, High Temp	12	395314012	395314312	395314412	395314512	395314812	395314912	62.96	2.479	55.88	2.200				
5.08mm, Euro Header, Vertical, High Temp	13	395314013	395314313	395314413	395314513	395314813	395314913	68.04	2.679	60.96	2.400				
5.08mm, Euro Header, Vertical, High Temp	14	395314014	395314314	395314414	395314514	395314814	395314914	73.12	2.879	66.04	2.600				
5.08mm, Euro Header, Vertical, High Temp	15	395314015	395314315	395314415	395314515	395314815	395314915	78.20	3.079	71.12	2.800				
5.08mm, Euro Header, Vertical, High Temp	16	395314016	395314316	395314416	395314516	395314816	395314916	83.28	3.279	76.20	3.000				
5.08mm, Euro Header, Vertical, High Temp	17	395314017	395314317	395314417	395314517	395314817	395314917	88.36	3.479	81.28	3.200				
5.08mm, Euro Header, Vertical, High Temp	18	395314018	395314318	395314418	395314518	395314818	395314918	93.44	3.679	86.36	3.400				
5.08mm, Euro Header, Vertical, High Temp	19	395314019	395314319	395314419	395314519	395314819	395314919	98.52	3.879	91.44	3.600				
5.08mm, Euro Header, Vertical, High Temp	20	395314020	395314320	395314420	395314520	395314820	395314920	103.60	4.079	96.52	3.800				
5.08mm, Euro Header, Vertical, High Temp	21	395314021	395314321	395314421	395314521	395314821	395314921	108.68	4.279	101.60	4.000				
5.08mm, Euro Header, Vertical, High Temp	22	395314022	395314322	395314422	395314522	395314822	395314922	113.76	4.479	106.68	4.200				
5.08mm, Euro Header, Vertical, High Temp	23	395314023	395314323	395314423	395314523	395314823	395314923	118.84	4.679	111.76	4.400				
5.08mm, Euro Header, Vertical, High Temp	24	395314024	395314324	395314424	395314524	395314824	395314924	123.92	4.879	116.84	4.600				

TOLERANCES			
MM	TOL	INCH	TOL
0-6	±0.25	0-.24	±.010
>6-30	±0.40	.24-1.18	±.016
>30-120	±0.50	1.18-4.76	±.020
>120	±0.80	>4.76	±.031

SYMBOLS = 0 = 0 = 0 = 0 = 0 = 0 = 0 = 0 = 0	THIS DRAWING CONTAINS INFORMATION THAT IS PROPRIETARY TO MOLEX ELECTRONIC TECHNOLOGIES, LLC AND SHOULD NOT BE USED WITHOUT WRITTEN PERMISSION DIMENSION UNITS: MM[INCH] SCALE: 4:1 CURRENT REV DESC: REMOVED GREEN PART NUMBERS	 5.08MM, EURO HEADER, VERTICAL, HI-TEMP PRODUCT CUSTOMER DRAWING	
	GENERAL TOLERANCES (UNLESS SPECIFIED)		EC NO: 175526 DRWN: ABENJAMINLW 2018/04/13 CHK'D: BRUPERT 2018/04/24 APPR: BRUPERT 2018/04/25
	4 PLACES ± --- ± --- 3 PLACES ± --- ± --- 2 PLACES ± --- ± --- 1 PLACE ± --- ± --- 0 PLACES ± --- ± ---		INITIAL REVISION: DRWN: LROTHAUS 2005/12/06 APPR:
	ANGULAR TOL ± ---° DRAFT WHERE APPLICABLE MUST REMAIN WITHIN DIMENSIONS		THIRD ANGLE PROJECTION DRAWING: B-SIZE SERIES: 39531 MATERIAL NUMBER: SEE CHART CUSTOMER: GENERAL MARKET SHEET NUMBER: 2 OF 2