

## General Safety Instructions:



### READ SAFETY INSTRUCTIONS

#### Servicing:

These products are not customer serviceable. TDK-Lambda and their authorised agents only are permitted to carry out repairs.

#### Critical Components:

These products are not authorised for use as critical components in nuclear control systems, life support systems or equipment for use in hazardous environments without the express written approval of the Managing Director of TDK-Lambda EMEA.

#### Product Usage:

These products are designed for use within a host equipment which restricts access to authorised competent personnel.

This product is a component power supply and is only to be installed by qualified persons within other equipment and must not be operated as a stand-alone product.

This product is for sale to business to business customers and can be obtained via distribution channels. It is not intended for sale to end users.

This product is a component power supply and complies with the EMC directive. The EMC performance of a component power supply will be affected by the final installation, compliance to the stated EMC standards and conformance to the EMC Directive must be confirmed after installation by the final equipment manufacturer.

For guidance with respect to test conditions please visit our website at [https://emea.tdk-lambda.com/EMC\\_guidance](https://emea.tdk-lambda.com/EMC_guidance) or contact your local TDK-Lambda sales office.

#### Environmental:

These products are IPX0, and therefore chemicals/solvents, cleaning agents and other liquids must not be used.

#### Environment:

This power supply is a switch mode power supply for use in applications within a Pollution Degree 2, overvoltage category II environment. Material Group IIIb PCB's are used within it.

#### Output Loading:

The output power taken from the power supply must not exceed the rating stated on the power supply label, except as stated in the product limitations in this handbook.

#### Input Parameters:

This product must be operated within the input parameters stated in the product limitations in this handbook.

#### End of Life Disposal:

The unit contains components that require special disposal. Make sure that the unit is properly disposed of at the end of its service life and in accordance with local regulations.



## RISK OF ELECTRIC SHOCK

### High Voltage Warning:

Dangerous voltages are present within the power supply. The professional installer must protect service personnel from inadvertent contact with these dangerous voltages in the end equipment.

**WARNING:** When installed in a Class I end equipment, this product must be reliably earthed and professionally installed.

The (+) or (-) output(s) can be earthed or left floating. The unit cover(s)/chassis must not be made user accessible. The mains input connector is not acceptable for use as field wiring terminals. Do not use mounting screws, which penetrate the unit more than 3mm (FPS/RFE1000), 6mm (HFE/RFE1600/2500 & racks). Special earthing screws are used on these products which connect the cover to the chassis. They must not be removed. If they are removed by mistake, they must be replaced with new ones and the product tested for earth bonding.

This unit must be securely mounted and its earth terminal/baseplate properly bonded to the main protective earth before any connection to the MAINS supply is made. An internal fuse protects the unit and must not be replaced by the user. In case of internal defect, the unit must be returned to TDK-Lambda or one of their authorised agents. A suitable mechanical, electrical and fire enclosure must be provided by the end use equipment for mechanical, electric shock and fire hazard protection.

### Energy Hazards:

Certain modules are capable of providing hazardous energy (240VA) according to output voltage setting. Final equipment

# Power Supplies for Build-in

---

manufacturers must provide protection to service personnel against inadvertent contact with these module output terminals. If set such, that hazardous energy can occur, then the module terminals or connections must not be user accessible.

**Disconnect device:** An appropriate disconnect device shall be incorporated in the building installation wiring. Refer to the user manual of the specific model for more details.

## **Rack mounting safety instructions:**

A) Elevated Operating Ambient - If installed in a closed or multi-unit rack assembly, the operating ambient temperature of the rack environment may be greater than room ambient. Therefore, consideration should be given to installing the equipment in an environment compatible with the maximum ambient temperature (T<sub>ma</sub>) specified by the manufacturer.

B) Reduced Air Flow - Installation of the equipment in a rack should be such that the amount of air flow required for safe operation of the equipment is not compromised.

C) Mechanical Loading - Mounting of the equipment in the rack should be such that a hazardous condition is not achieved due to uneven mechanical loading.

D) Circuit Overloading - Consideration should be given to the connection of the equipment to the supply circuit and the effect that overloading of the circuits might have on overcurrent protection and supply wiring. Appropriate consideration of equipment nameplate ratings should be used when addressing this concern.

E) Reliable Earthing - Reliable earthing of rack-mounted equipment should be maintained. Particular attention should be given to supply connections other than direct connections to the branch circuit (e.g. use of power strips).



## **HOT SURFACE**

### **External Hot Surfaces:**

In accordance with local regulations for Health and Safety at work, manufacturers have an obligation to protect service engineers as well as users. In order to comply with this, a label must be fitted to these products which is clearly visible to service personnel accessing the overall equipment, and which legibly warns that surfaces of these products may be hot and must not be touched when the products are in operation.

The unit may be mounted in any orientation except inverted (mounted on its top) or vertical with the airflow downwards. The ventilation openings on these products must not be impeded. Ensure that there is at least 50mm spacing between any obstruction and the ventilation openings.

The unit cover/chassis is designed to protect skilled personnel from hazards. They must not be used as part of the external covers of any equipment where they may be accessible to operators, since under full load conditions, part or parts of the unit chassis may reach temperatures in excess of those considered safe for operator access.

**DEUTSCH****Allgemeine Sicherheitsvorschriften:****LESEN SIE DIE SICHERHEITSVORSCHRIFTEN****Wartung:**

Diese Produkte können nicht durch den Kunden gewartet werden. Nur TDK-Lambda und deren zugelassene Vertriebshändler sind zur Durchführung von Reparaturen berechtigt.

**Kritische Komponenten:**

Diese Produkte sind nicht für die Verwendung als kritische Komponenten in nuklearen Kontrollsystemen, Lebenserhaltungssystemen oder Geräten in gefährlichen Umgebungen geeignet, sofern dies nicht ausdrücklich und in Schriftform durch den Geschäftsführer von TDK-Lambda EMEA genehmigt wurde.

**Produktverwendung:**

Diese Produkte sind zur Verwendung innerhalb von Host-Anlagen gedacht, die einen auf das Fachpersonal beschränkten Zugang haben.

Dieses Produkt ist eine Stromversorgungs-Komponente und sie darf nur von qualifiziertem Personal in andere Geräte eingebaut werden und sie darf NICHT als eigenständiges ("Stand-Alone") Gerät betrieben werden.

Dieses Produkt ist für den Verkauf an Geschäftskunden entwickelt worden und es kann über Distributionskanäle bezogen werden.

Es ist NICHT für den Verkauf an Endkunden gedacht und konzipiert.

Dieses Produkt ist ein Komponenten-Netzteil und entspricht der EMV-Richtlinie. Das EMV-Verhalten eines Einbaunetzteiles wird von der Einbausituation im Endgerät maßgeblich beeinflusst. Die Übereinstimmung mit den angegebenen EMV-Normen und die Erfüllung der EMV-Richtlinie muss nach dem Einbau vom Endgerätehersteller nachgewiesen werden.

Für Anwendungshinweise besuchen Sie bitte unsere Website auf [https://emea.tdk-lambda.com/ EMC\\_guidance](https://emea.tdk-lambda.com/EMC_guidance) oder kontaktieren Sie Ihr lokales TDK-Lambda Vertriebsbüro.

**Umwelt:**

Diese Produkte sind IPX0, aus diesem Grund dürfen keine Chemikalien/Lösungsmittel, Reinigungsmittel und andere Flüssigkeiten verwendet werden.

**Umgebung:**

Dieses Netzteil ist ein Schaltnetzteil zur Verwendung in einer Umgebung mit einem Verschmutzungsgrad 2, Überspannungskategorie II. Materialgruppe IIIb mit darin verwendeten PCBs.

**Ausgangsstrom:**

Der Ausgangsstrom des Netzteiles darf die Leistung, die auf dem Label des Netzteiles vermerkt ist, nur dann überschreiten, wenn dies in den Produktgrenzen dieses Handbuches ausgezeichnet ist.

**Eingangsparameter:**

Dieses Produkt muss innerhalb der Eingangsparameter, die in den Produktgrenzen dieses Handbuches angegeben sind, betrieben werden.

**Entsorgung am Ende der Betriebszeit:**

Das Gerät enthält Komponenten die unter Sondermüll fallen. Das Gerät muss am Ende der Betriebszeit ordnungsgemäß und in Übereinstimmung mit den regionalen Bestimmungen entsorgt werden.

**GEFAHR DURCH ELEKTRISCHEN SCHLAG****Hochspannungswarnung:**

Innerhalb des Netzteiles gibt es gefährliche Spannungen. Der Elektroinstallateur muss das Wartungspersonal vor versehentlichem Kontakt mit den gefährlichen Spannungen im Endgerät schützen.

**WARNUNG!** Falls Sie unser Netzgerät in eine Anwendung mit Schutzklasse 1 eingebaut haben, stellen Sie sicher, dass es fachgerecht installiert und zuverlässig geerdet ist.

Die (+) oder (-) Ausgänge können geerdet werden oder unangeschlossen bleiben.

Die Abdeckung des Gerätes/das Gehäuse darf für den Benutzer nicht zugänglich sein. Der Haupteingangsanschluss ist nicht für die Verwendung als Feldverdrahtungsanschluss geeignet. Verwenden Sie keine Befestigungsschrauben, die mehr

# Power Supplies for Build-in

als 3mm (FPS/RFE 1000), 6mm (HFE/RFE 1600/2500, racks) in das Gerät eindringen. Zur Befestigung der Abdeckung am Gehäuse werden für diese Produkte spezielle Erdungsschrauben verwendet. Diese dürfen nicht entfernt werden. Sollten sie versehentlich entfernt werden, müssen sie durch neue ersetzt und das Produkt auf Erdschluss geprüft werden. Vor dem Anschließen an die AC-Hauptstromversorgung muss das Gerät sicher montiert und die Grundplatte korrekt an die Schutz Erde angeschlossen sein. Eine interne Sicherung schützt das Gerät und darf durch den Benutzer nicht ausgetauscht werden. Im Fall von internen Defekten muss das Gerät an TDK-Lambda oder einen der autorisierten Vertriebs Händler zurückgeschickt werden. Ein geeignetes mechanisches, elektrisches und brandgeschütztes Gehäuse muss als Schutz vor der Gefahr von mechanischen Risiken, Stromschlägen und Brandschutz in dem Endgerät vorgesehen werden.

## **Gefahren durch elektrische Energie:**

Von bestimmten Modulen kann je nach Einstellung der Ausgangsspannung gefährliche elektrische Energie ausgehen (240 VA). Die Endgerätehersteller müssen einen Schutz für Servicepersonal vor unbeabsichtigtem Kontakt mit den Ausgangsanschlüssen dieser Module vorsehen. Kann aufgrund der Einstellung gefährliche elektrische Energie auftreten, dürfen die Modulanschlüsse für den Benutzer nicht zugänglich sein.

**Trennvorrichtung:** Eine geeignete Trennvorrichtung muss in die Verkabelung der Gebäudeinstallation integriert werden. Weitere Einzelheiten finden Sie im Benutzerhandbuch des jeweiligen Modells.

## **Sicherheitshinweise für die Gestellmontage:**

A) Erhöhte Betriebsumgebung - Wenn das Gerät in einem geschlossenen oder mehrteiligen Gestell installiert wird, kann die Betriebsumgebungstemperatur der Gestellumgebung höher sein als die Raumtemperatur. Daher sollte die Installation des Geräts in einer Umgebung in Betracht gezogen werden, die mit der vom Hersteller angegebenen maximalen Umgebungstemperatur (T<sub>ma</sub>) kompatibel ist.

B) Reduzierter Luftstrom - Die Installation der Geräte in einem Gestell sollte so erfolgen, dass der für den sicheren Betrieb der Geräte erforderliche Luftstrom nicht beeinträchtigt wird.

C) Mechanische Belastung - Die Montage des Geräts im Gestell sollte so erfolgen, dass durch ungleichmäßige mechanische Belastung kein gefährlicher Zustand entsteht.

D) Überlastung des Stromkreises - Der Anschluss des Geräts an den Versorgungsstromkreis und die Auswirkungen, die eine Überlastung der Stromkreise auf den Überspannungsschutz und die Versorgungskabel haben könnte, sollten berücksichtigt werden. Berücksichtigen Sie dabei die Angaben auf dem Typenschild des Geräts.

E) Zuverlässige Erdung - Die zuverlässige Erdung von Geräten im Gestell sollte beibehalten werden. Besondere Aufmerksamkeit sollte anderen Versorgungsanschlüssen als dem direkten Anschluss an den Zweigstromkreis (z. B. Verwendung von Steckdosenleisten) gewidmet werden.



## **HEISSE OBERFLÄCHEN**

### **Äußere heiße Oberflächen:**

In Übereinstimmung mit den regionalen Bestimmungen für Gesundheit und Sicherheit bei der Arbeit ist der Hersteller für den Schutz von Wartungspersonal und Benutzern verantwortlich. Um diesen Bestimmungen gerecht zu werden, muss auf den Produkten ein Label angebracht werden, das deutlich sichtbar für das Wartungspersonal mit Zugriff auf die gesamte Anlage ist, und das gut lesbar auf die eventuell heiße Oberfläche des Gerätes hinweist und das Berühren des Produktes in Betrieb untersagt.

Das Gerät darf in jeder Position befestigt werden, mit Ausnahme über Kopf (umgekehrt) oder vertikal mit dem Luftstrom abwärts.

Die Belüftungsöffnungen an diesem Produkt dürfen nicht blockiert werden. Achten Sie darauf, dass mindestens 50 mm Abstand zwischen Hindernissen und den Belüftungsöffnungen bleibt.

Die Geräteabdeckung/das Gehäuse ist so entworfen, dass das Fachpersonal vor Gefahren geschützt wird. Sie dürfen nicht als Teil der externen Abdeckung für Geräte verwendet werden, die für den Betreiber zugänglich sein müssen, da Teile oder das gesamte Gerätegehäuse unter voller Auslastung übermäßige Temperaturen erreichen kann, die für den Zugang des Betreibers nicht mehr als sicher betrachtet werden.

**FRANÇAIS****Consignes générales de sécurité:****LIRE LES CONSIGNES DE SECURITE****Entretien:**

Ces produits ne peuvent pas être réparés par l'utilisateur. Seuls, TDK-Lambda et ses agents agréés sont autorisés à effectuer des réparations.

**Composants critiques:**

Ces produits ne doivent pas être utilisés en tant que composants critiques dans des systèmes de commande nucléaire, dans des systèmes de sauvetage ou dans des équipements utilisés dans des environnements dangereux, sans l'autorisation écrite expresse du directeur général de TDK-Lambda EMEA.

**Utilisation du produit:**

Ces produits sont conçus pour être utilisés dans un équipement hôte dont l'accès n'est autorisé qu'aux personnes compétentes. Ce produit est une alimentation considérée comme un composant devant être installé par des personnes qualifiées, dans un autre équipement. Il ne doit pas être utilisé en tant que produit fini.

Ce produit est destiné à la vente entre entreprises et peut être obtenu via des canaux de distribution. Il n'est pas prévu à la vente pour les particuliers.

Ce produit est un composant d'alimentation électrique et est conforme à la directive EMC. La performance CEM d'une alimentation considérée comme un composant d'un équipement sera affectée par l'équipement final, la conformité aux normes CEM énoncée et la conformité à la directive CEM doivent être confirmées après installation de l'alimentation par le fabricant de l'équipement final.

Pour obtenir des conseils concernant nos conditions d'essai, veuillez consulter notre site Web à l'adresse [https://emea.tdk-lambda.com/EMC\\_guidance](https://emea.tdk-lambda.com/EMC_guidance) ou contacter votre bureau de vente local TDK-Lambda.

**Environnement:**

Ces produits sont IPX0, et donc on ne doit pas utiliser des produits chimiques/solvants, des produits de nettoyage et d'autres liquides.

**Environnement fonctionnel:**

Cette alimentation fonctionne en mode commutation pour utilisation dans des applications fonctionnant dans un environnement avec Degré de Pollution 2 et catégorie de surtension II. Elle utilise des cartes des circuits imprimés (PCB) de Groupe IIIb.

**Intensité soutirée:**

L'intensité soutirée de l'alimentation ne doit pas dépasser l'intensité nominale marquée sur la plaque signalétique, sauf indications contraires dans les limitations du produit décrit dans ce manuel."

**Paramètres d'entrée:**

Ce produit doit être utilisé à l'intérieur des paramètres d'entrée indiqués dans les limitations du produit dans ce manuel.

**Elimination en fin de vie:**

L'alimentation contient des composants nécessitant des dispositions spéciales pour leur élimination. Vérifiez que cette alimentation est mise au rebut correctement en fin de vie utile et conformément aux réglementations locales en vigueur."

**RISQUE DE CHOC ELECTRIQUE****Attention-Danger haute tension:**

Des tensions dangereuses sont présentes dans l'alimentation. L'installateur doit protéger le personnel d'entretien contre un contact involontaire avec ces tensions dangereuses dans l'équipement final.

**AVERTISSEMENT:** Si ce produit est installé dans un équipement final de classe I, il doit être mis à la terre de manière fiable et installé par un professionnel averti.

Les sorties (+) ou (-) peuvent être raccordées à la terre ou laissées flottantes. Le couvercle/châssis de l'alimentation ne doit pas être accessible à l'utilisateur.

Le connecteur d'entrée d'alimentation principale ne doit pas être utilisé comme borne de raccordement. N'utilisez pas de

# Power Supplies for Build-in

vis pénétrant dans le module sur une profondeur supérieure à 3mm (FPS/RFE 1000), 6mm (HFE/RFE 1600/2500, racks). Des vis de terre spéciales sont utilisées sur ces produits pour raccorder le couvercle au châssis. Elles ne doivent pas être enlevées. Si elles sont enlevées par erreur, elles doivent être remplacées et le produit doit être testé pour vérifier que le raccordement à la terre est correct.

Ce module doit être solidement installé et sa plaque de base doit être raccordée à la terre de protection principale avant d'être raccordée à l'alimentation principale AC. Un fusible interne protège le module et ne doit pas être remplacé par l'utilisateur. En cas de défaut interne, le module doit être renvoyé à TDK-Lambda ou l'un de ses agents agréés. Une enceinte appropriée doit être prévue par l'utilisateur final pour assurer la protection contre les chocs mécaniques, les chocs électriques et l'incendie.

## Energies dangereuses:

Certains modules peuvent générer une énergie dangereuse (240 VA) selon le réglage de tension de sortie. Le fabricant de l'équipement final doit assurer la protection des techniciens d'entretien contre un contact involontaire avec les bornes de sortie de ces modules. Si une telle tension dangereuse risque de se produire, les bornes ou les connexions du module ne doivent pas être accessibles par l'utilisateur.

**Dispositif de déconnexion** : Un dispositif de déconnexion approprié sera intégré au câblage de l'installation du bâtiment. Consultez le manuel d'utilisation du modèle spécifique pour plus de détails.

## Consignes de sécurité pour le montage en rack :

A) Température ambiante de fonctionnement élevée : Si l'équipement est installé dans un rack fermé ou à plusieurs unités, la température ambiante de fonctionnement de l'environnement du rack peut être supérieure à la température ambiante de la pièce. Par conséquent, il convient de privilégier lors de l'installation de l'équipement un environnement compatible avec la température ambiante maximale (T<sub>ma</sub>) recommandée par le fabricant.

B) Débit d'air réduit : L'installation de l'équipement en rack doit permettre que la quantité de débit d'air nécessaire pour un fonctionnement sûr de l'équipement ne soit pas compromise.

C) Chargement mécanique : Le montage de l'équipement en rack doit être exempt de tout risque dû à une charge mécanique inégale.

D) Surcharge des circuits : Une attention particulière doit être apportée lors du raccord de l'équipement au circuit d'alimentation électrique, et à l'effet que la surcharge des circuits pourrait avoir sur la protection contre les surintensités et le câblage d'alimentation. Il est recommandé à cet effet de tenir compte des valeurs nominales sur la plaque signalétique de l'équipement.

E) Mise à la terre fiable : Une mise à la terre fiable de l'équipement monté en rack doit être maintenue. Une attention particulière doit être accordée aux raccords d'alimentation autres que les raccords directs au circuit de dérivation (par exemple, l'utilisation de multiprises).



## SURFACE CHAUDE

### Surfaces chaudes extérieures:

Conformément aux réglementations locales concernant la santé et la sécurité sur les lieux de travail, les fabricants doivent protéger les techniciens d'entretien et les utilisateurs. Pour cela, une plaque signalétique doit être installée sur ces produits, et cette plaque doit être bien visible pour les techniciens d'entretien intervenant sur l'équipement, et elle doit indiquer de manière bien visible par les surfaces de ces produits peuvent être chaudes et qu'elles ne doivent pas être touchées lorsque les produits fonctionnent.

Le module peut être monté suivant une orientation quelconque, sauf en position inversée (monté sur son sommet) ou en position verticale avec écoulement d'air descendant.

Les orifices de ventilation sur ces produits ne doivent pas être obstrués. Vérifiez qu'il y a un espace libre d'au moins 50 mm entre une obstruction et les orifices de ventilation.

Le couvercle et le châssis du module sont conçus pour protéger des personnels expérimentés. Ils ne doivent pas être utilisés comme couvercles extérieurs d'un équipement, accessible aux opérateurs car en condition de puissance maximum, des parties du châssis peuvent atteindre des températures considérées comme dangereuses pour l'opérateur.

**ITALIANO****Norme generali di sicurezza:****SI PREGA DI LEGGERE LE NORME DI SICUREZZA****Manutenzione:**

Il cliente non può eseguire alcuna manutenzione su questi prodotti. L'esecuzione delle eventuali riparazioni è consentita solo a TDK-Lambda e ai suoi agenti autorizzati.

**Componenti critici:**

Non si autorizza l'uso di questi prodotti come componenti critici all'interno di sistemi di controllo nucleari, sistemi necessari alla sopravvivenza o apparecchiature destinate all'impiego in ambienti pericolosi, senza l'esplicita approvazione scritta dell'Amministratore Delegato di TDK-Lambda EMEA.

**Uso dei prodotti:**

Questi prodotti sono progettati per l'uso all'interno di un'apparecchiatura ospite che limiti l'accesso al solo personale competente e autorizzato. Questo prodotto è da considerarsi come un alimentatore professionale componente e come tale deve essere installato da personale qualificato all'interno di altre apparecchiature e non può essere utilizzato come prodotto indipendente.

Questo prodotto non è inteso per la vendita al dettaglio o agli utilizzatori finali.

Questo prodotto è un alimentatore componenti ed è conforme alla direttiva EMC. Le prestazioni EMC di un alimentatore utilizzato come componente di un'apparecchiatura saranno influenzate dal montaggio finale, la conformità alle norme EMC indicate e la conformità alla direttiva EMC dovranno essere confermata dopo l'installazione dell'alimentatore da parte del produttore dell'apparecchiatura finale.

Per indicazioni riguardanti le condizioni di test si prega di visitare il nostro sito web all'indirizzo [https://emea.tdk-lambda.com/EMC\\_guidance](https://emea.tdk-lambda.com/EMC_guidance) o contattare l'ufficio vendite TDK-Lambda locale.

**Condizioni ambientali:**

Questi prodotti sono classificati come IPX0, dunque non devono essere utilizzati sostanze chimiche/solventi, prodotti per la pulizia o liquidi di altra natura.

**Ambiente:**

Questo prodotto è un alimentatore a commutazione, destinato all'uso in applicazioni rientranti in ambienti con le seguenti caratteristiche: Livello inquinamento 2, Categoria sovratensione II. Questo prodotto contiene schede di circuiti stampati in materiali di Gruppo IIIb.

**Carico in uscita:**

La potenza in uscita ottenuta dall'alimentatore non deve superare la potenza nominale indicata sulla targhetta dell'alimentatore, fatto salvo dove indicato nei limiti per il prodotto specificati in questo manuale.

**Parametri di alimentazione:**

Questo prodotto deve essere utilizzato entro i parametri di alimentazione indicati nei limiti per il prodotto, specificati in questo manuale."

**Smaltimento:**

L'unità contiene componenti che richiedono procedure speciali di smaltimento. Accertarsi che l'unità venga smaltita in modo corretto al termine della vita utile e nel rispetto delle normative locali.

**RISCHIO DI SCOSSA ELETTRICA****Avvertimento di alta tensione:**

All'interno dell'alimentatore sono presenti tensioni pericolose. Gli installatori professionali devono proteggere il personale di manutenzione dal rischio di contatto accidentale con queste tensioni pericolose all'interno dell'apparecchiatura finale.

**ATTENZIONE:** Se installato in un'attrezzatura di classe I, questo prodotto deve essere collegato a terra in modo affidabile ed installato in modo professionale.

Le uscite (+) o (-) possono essere messa a terra o lasciate isolate.

I coperchi/il telaio dell'unità non devono essere accessibili da parte dell'utente.

# Power Supplies for Build-in

Il connettore dell'alimentazione principale non può essere utilizzato come terminale di collegamento di campo. Non utilizzare viti che penetrano nell'unità per più di 3mm (FPS/RFE 1000), 6mm (HFE/RFE 1600/2500, racks). Per questi prodotti vengono usate viti speciali di messa a terra, che collegano il coperchio al telaio. Tali viti non devono essere rimosse. Se le viti vengono tolte per errore, vanno sostituite con nuove viti ed occorre testare il prodotto per verificarne il collegamento a massa. Questa unità deve essere fissata in modo saldo e la sua piastra di base deve aderire correttamente alla messa a terra protettiva di rete prima di procedere a qualsiasi collegamento all'alimentazione di rete a CA.

Un fusibile interno protegge l'unità e non deve essere sostituito dall'utente. Nell'eventualità di un difetto interno, restituire l'unità a TDK-Lambda o a uno dei suoi agenti autorizzati. L'apparecchiatura finale deve includere una recinzione meccanica, elettrica e antincendio per proteggere dai pericoli di natura meccanica, dalle scosse elettriche e dai pericoli di incendio.

## **Pericoli energetici:**

Alcuni moduli sono in grado di erogare energia pericolosa (240 VA) a seconda della tensione in uscita impostata. I produttori delle apparecchiature finali sono tenuti a proteggere il personale di manutenzione dal rischio di contatto accidentale con questi terminali dei moduli di uscita. Se impostati su livelli che non escludono l'erogazione di energia pericolosa, questi terminali o collegamenti non devono risultare accessibili

**Dispositivo di disattivazione:** un dispositivo di disattivazione appropriato sarà incorporato nell'impianto elettrico dell'edificio. Vedere il manuale utente del modello specifico per ulteriori informazioni.

## **Istruzioni di sicurezza del montaggio in rack:**

A) Ambiente di esercizio elevato - Se l'unità viene installata in un gruppo chiuso o in un rack con più unità, la temperatura ambiente di esercizio dell'ambiente rack potrebbe essere maggiore rispetto a quella della stanza. Di conseguenza, occorre prendere in considerazione l'installazione dell'apparecchiatura in un ambiente compatibile con la temperatura ambiente massima (Tma) specificata dal produttore.

B) Flusso d'aria ridotto - L'installazione dell'apparecchiatura in un rack deve essere tale da non compromettere la quantità di flusso d'aria necessaria per un funzionamento sicuro dell'apparecchiatura.

C) Carico meccanico - Il montaggio dell'apparecchiatura nel rack deve essere tale da non creare una condizione di pericolo a causa di un carico meccanico non omogeneo.

D) Sovraccarico del circuito - È necessario valutare il collegamento dell'apparecchiatura al circuito di alimentazione e l'effetto che il sovraccarico dei circuiti potrebbe avere sulla protezione da sovracorrente e il cablaggio di alimentazione. È necessario prendere in appropriata considerazione i valori nominali di targa dell'apparecchiatura quando si affronta questo problema.

E) Messa a terra sicura - Deve essere mantenuta una messa a terra sicura dell'apparecchiatura montata su rack. Deve essere prestata particolare attenzione alle connessioni di alimentazione diverse dalle connessioni dirette al circuito di derivazione (per esempio uso di prese multiple).



da parte dell'utente.

## **SUPERFICIE CALDA**

### **Superfici esterne calde:**

Coerentemente con le norme locali in materia di salute & sicurezza professionali, i produttori sono tenuti a salvaguardare i tecnici di manutenzione, e inoltre gli utenti. Per far fronte a tali obblighi, i prodotti devono presentare una targhetta, chiaramente visibile al personale di manutenzione che accede all'apparecchiatura nel complesso e che risulti inoltre leggibile e avverta gli addetti del rischio che le superfici di questi prodotti possono scottare e non vanno toccate con i prodotti in funzione.

L'unità può essere installata in qualunque orientamento, ma non in posizione capovolta o in posizione verticale con il flusso dell'aria rivolto verso il basso. Le griglie di ventilazione su questi prodotti non devono essere ostruite. Verificare che vi sia una distanza minima di 50 mm fra le griglie di ventilazione e qualsiasi eventuale ostruzione.

Il coperchio/telaio dell'unità è realizzato per proteggere il personale esperto dai pericoli. Non deve essere usato come parte degli involucri esterni di qualsiasi apparecchiatura, se risulta accessibile da parte degli addetti, poiché è possibile che in condizioni di pieno carico una o più parti del telaio dell'unità giunga/giungano a temperature superiori ai limiti considerati sicuri per l'accesso da parte degli addetti.



**Instrucciones generales de seguridad:****LEA LAS INSTRUCCIONES DE SEGURIDAD****Servicio:**

Estos productos no pueden ser reparados por los clientes. TDK-Lambda y sus agentes autorizados son los únicos que pueden llevar a cabo las reparaciones.

**Componentes fundamentales:**

Estos productos no pueden ser utilizados como componentes fundamentales en sistemas de control nuclear, sistemas de soporte vital o equipos a utilizar en entornos peligrosos sin el consentimiento expreso por escrito del Director General de TDK-Lambda EMEA.

**Uso de los productos:**

Estos productos han sido diseñados para ser utilizados en un equipo central que restrinja el acceso al personal cualificado autorizado.

Este producto es una fuente de alimentación y sólo puede ser instalado por personal cualificado dentro de otros equipos y no debe ser tratado como un producto independiente. Este producto debe ser vendido entre empresas profesionales y solo puede obtenerse a través de los canales de distribución. No está destinado para la venta a usuarios finales.

Este producto es una fuente de alimentación de componentes y cumple con la directiva EMC. El rendimiento de CEM del suministro eléctrico de un componente se verá afectado por la instalación final; el fabricante del equipo final debe confirmar el cumplimiento de las normas CEM establecidas y la conformidad con la Directiva CEM después de la instalación. Si desea orientación sobre las condiciones de prueba, visite nuestro sitio web en [https://emea.tdk-lambda.com/EMC\\_guidance](https://emea.tdk-lambda.com/EMC_guidance) o póngase en contacto con la oficina de ventas local de TDK-Lambda.

**Medioambiental:**

Estos productos son IPX0 y, por tanto, no pueden utilizarse sustancias químicas/disolventes, agentes de limpieza ni otros líquidos.

**Medio ambiente:**

Esta fuente de alimentación es una fuente de alimentación de modo conmutado a utilizar en aplicaciones dentro de un entorno con un Grado de contaminación 2 y una Categoría de sobretensión II. En él se utilizan policloruros de bifenilo del Grupo de materiales IIIb.

**Carga de salida:**

La potencia de salida tomada de la fuente de alimentación no puede sobrepasar el valor nominal indicado en la etiqueta de la fuente de alimentación, excepto en los casos indicados en las limitaciones del producto en este manual.

**Parámetros de entrada:**

Este producto debe ser utilizado dentro de los parámetros de entrada indicados en las limitaciones del producto en este manual.

**Desecho de la unidad:**

La unidad contiene componentes que deben ser desechados de una manera especial. Asegúrese de desechar correctamente la unidad al final de su vida útil y conforme a las normas locales vigentes.

**PELIGRO DE DESCARGAS ELÉCTRICAS****Advertencia de alta tensión:**

En esta fuente de alimentación hay tensiones peligrosas. El instalador profesional debe proteger al personal de servicio contra cualquier contacto accidental con estas tensiones peligrosas en el equipo final.

**ADVERTENCIA:** La instalación de este producto en un equipo de clase I la deben llevar a cabo profesionales y el producto debe estar conectado a tierra.

La salida o salidas (+) o (-) pueden conectarse a tierra o se las puede dejar flotando.

Debe impedirse el acceso de los usuarios a la cubierta o cubiertas y al chasis de la unidad.

El conector de entrada de la red no es apto para ser utilizado a modo de bornes de cableado de campo. No utilice tornillos de montaje susceptibles de penetrar en la unidad más de 3mm (FPS/RFE 1000), 6mm (HFE/ RFE 1600/2500, racks). Con estos productos se utilizan unos tornillos de puesta a tierra especiales que conectan la cubierta al chasis. No se deben quitar en

# Power Supplies for Build-in

ningún caso. En caso de quitarlos por error, hay que reemplazarlos por unos nuevos y comprobar la conexión a tierra del producto.

Esta unidad se debe montar de forma que quede firmemente aseguradas y su placa base quede bien conectada a la toma de tierra de protección principal antes de establecer cualquier conexión a la fuente de alimentación de CA de la red. Un fusible interno protege la unidad y este no debe ser nunca reemplazado por el usuario. En caso de existir algún defecto interno, la unidad debe ser enviada a TDK-Lambda o a uno de sus agentes autorizados. El equipo de uso final debe constituir un recinto de protección mecánica, eléctrica y contra incendios de protección mecánica, contra descargas eléctricas y contra el peligro de incendios.

## **Peligros de energía:**

Algunos módulos pueden generar energía peligrosa (240VA) dependiendo de la configuración de la tensión de salida. Los fabricantes de equipos finales deben proteger al personal de servicio contra un contacto accidental con estos bornes de salida de los módulos. Si se configura de modo que pueda generarse energía peligrosa, hay que evitar que el usuario pueda acceder a los bornes o conexiones del módulo.

**Dispositivo de desconexión:** Se debe incorporar un dispositivo de desconexión apropiado en el cableado de instalación del edificio. Consulte el manual de usuario del modelo específico para obtener más detalles.

## **Instrucciones de seguridad para el montaje en bastidor:**

A) Temperatura Ambiente de Funcionamiento Elevada - si se instala en un conjunto de bastidor cerrado o de unidades múltiples, la temperatura ambiente de funcionamiento del entorno del bastidor puede ser mayor que la temperatura ambiente de la habitación. Por lo tanto, se debe considerar instalar el equipo en un entorno compatible con la temperatura ambiente máxima (T<sub>ma</sub>) especificada por el fabricante.

B) Flujo de Aire Reducido - la instalación del equipo en un bastidor debe ser tal que la cantidad de flujo de aire requerida para el funcionamiento seguro del equipo no se vea comprometida.

C) Carga Mecánica - el montaje del equipo en el bastidor debe prevenir que se produzca una condición peligrosa debido a una carga mecánica desigual.

D) Sobrecarga del Circuito - se debe considerar la conexión del equipo al circuito de alimentación y el efecto que la sobrecarga de los circuitos podría tener sobre la protección contra sobrecorriente y sobre el cableado de alimentación. Al abordar este asunto, debe tenerse muy en cuenta los valores de consumo definidos en la placa de identificación del equipo.

E) Conexión a Tierra Confiable - se debe mantener una conexión a tierra confiable del equipo montado en bastidor. Se debe prestar especial atención a las conexiones de alimentación que no sean conexiones directas al circuito derivado (por ejemplo, uso de regletas de enchufes).



## **SUPERFICIE CALIENTE**

### **Superficies externas calientes:**

Según las normas locales relativas a la Salud y Seguridad en el trabajo, los fabricantes están obligados a proteger a los ingenieros de servicio además de a los usuarios. Para que esto se cumpla, debe colocarse una etiqueta en estos productos que pueda ser vista claramente por el personal de servicio que accede al equipo general, y con advertencias legibles de que las superficies de estos productos pueden estar calientes y no deben tocarse cuando los productos se encuentran en funcionamiento.

La unidad se puede montar en cualquier orientación excepto invertida (montada sobre su parte de arriba) o vertical con los orificios para el flujo de aire mirando hacia abajo. Las aberturas de ventilación de estos productos no deben obstruirse jamás. Asegúrese de que quede una separación de 50 mm por lo menos entre cualquier obstrucción y las aberturas de ventilación.

La cubierta/chasis de la unidad ha sido diseñada para que proteja a las personas cualificadas de los peligros. No deben ser utilizadas como parte de las cubiertas externas de cualquier equipo al que pueden acceder los operarios, ya que bajo unas condiciones de carga completa, la pieza o piezas del chasis de la unidad pueden alcanzar temperaturas superiores a las consideradas seguras para el acceso de los operarios.

**PORTUGUÊS****Instruções gerais de segurança:****LEIA AS INSTRUÇÕES DE SEGURANÇA****Manutenção:**

Estes produtos não são podem ser submetidos a manutenção por parte do cliente. Apenas a TDK-Lambda e os seus agentes autorizados têm permissão para realizar reparações.

**Componentes essenciais:**

Não é autorizada a utilização destes produtos como componentes essenciais de sistemas de controlo nuclear, sistemas de suporte de vida ou equipamento para utilização em ambientes perigosos sem a expressa autorização por escrito do Director-Geral da TDK-Lambda EMEA.

**Utilização do produto:**

Estes produtos foram concebidos para utilização dentro de um equipamento de alojamento que apenas permita o acesso a pessoal qualificado autorizado.

Este produto é uma alimentação considerado com um componente para ser instalado por pessoas qualificadas, em outros equipamentos. Não deve ser usado como um produto acabado.

Este produto é destinado para venda entre as empresas e pode ser obtido através de canais de distribuição. Não se destina à venda aos particulares

Este produto é uma fonte de alimentação componente e está em conformidade com a directiva EMC.

O desempenho EMC da fonte de alimentação de um componente será afetado pela instalação final. Após a instalação, o fabricante do equipamento final tem de confirmar a conformidade com as normas EMC indicadas e a conformidade com a Directiva EMC. Para obter orientação relativamente às condições de teste, visite o nosso website, em [https://emea.tdk-lambda.com/EMC\\_guidance](https://emea.tdk-lambda.com/EMC_guidance), ou contacte o seu escritório de vendas local da TDK-Lambda.

**Ambiental:**

Estes produtos são IPX0 e, como tal, não se devem utilizar químicos/solventes, agentes de limpeza e outros líquidos.

**Ambiente:**

Esta fonte de alimentação é uma fonte de alimentação do modo de comutação para utilização em aplicações com um Nível de Poluição 2 e ambientes da categoria de sobretensão II. São utilizadas placas de circuitos impressos do grupo de materiais IIIb.

**Carga de saída:**

A potência de saída extraída da fonte de alimentação não deve exceder a classificação assinalada na etiqueta da fonte de alimentação, excepto quando indicado nas limitações do produto neste guia.

**Parâmetros de entrada:**

Este produto deve ser utilizado dentro dos parâmetros de entrada indicados nas limitações do produto neste guia.

**Eliminação no fim de vida:**

A unidade contém componentes que necessitam de procedimentos especiais de eliminação. Certifique-se de que a unidade é devidamente eliminada no fim da sua vida útil e que tal é feito em conformidade com os regulamentos locais.

**RISCO DE CHOQUE ELÉCTRICO****Aviso de alta tensão:**

Estão presentes tensões perigosas dentro da fonte de alimentação. O profissional que realizar a instalação deve proteger o pessoal de assistência contra contactos inadvertidos com estas tensões perigosas do equipamento final.

**AVISO:** Quando instalado num equipamento de Classe I, este produto deve ser ligado à terra de forma fiável e instalado por um profissional.

As saídas (+) e (-) podem ser ligadas à terra ou deixadas soltas.

O chassis/cobertura(s) da unidade não deve estar acessível ao utilizador.

O conector de entrada de alimentação não deve ser utilizado como terminal de cablagens no local. Não utilize parafusos de montagem, uma vez que estes penetrarão na unidade em mais do que 3mm (FPS/RFE 1000), 6mm (HFE/RFE 1600/2500, racks). Nestes produtos utilizam-se parafusos especiais de ligação à terra, que ligam a cobertura ao chassis. Não devem ser

# Power Supplies for Build-in

removidos. Se forem removidos por engano, deverão ser substituídos por parafusos novos, devendo-se testar a ligação à terra do produto.

A unidade deve ser instalada de forma segura e o seu suporte devidamente ligado à principal terra de protecção antes de se realizar qualquer ligação à fonte de alimentação de corrente alternada. Existe um fusível interno que protege a unidade e que não deve ser substituído pelo utilizador. Em caso de defeito interno, a unidade deve ser devolvida à TDK-Lambda ou a um dos seus agentes autorizados. O equipamento de utilização final deve fornecer um bastidor com protecção mecânica, eléctrica e contra incêndios adequada.

## Perigos de energia:

Alguns módulos tem a capacidade de fornecer energia perigosa (240 VA), de acordo com a configuração da tensão de saída. O equipamento final do fabricante deve garantir que o pessoal de assistência está protegido contra contactos inadvertidos com estes terminais de saída do módulo. Se essa energia perigosa for produzida, as ligações e os terminais do módulo não devem ser acessíveis pelos utilizadores.

**Desligar o dispositivo:** Na instalação da cablagem do edifício será incorporado um dispositivo para desligar. Consulte o manual do utilizador do modelo específico para obter mais detalhes.

## Instruções de segurança para a montagem do bastidor:

A) Ambiente de Operação Elevado – se o bastidor for instalado num local fechado ou com várias unidades, a temperatura ambiente de operação do bastidor deverá ser superior à temperatura ambiente do local. Por tal motivo, importa ter em conta que o bastidor deverá ser instalado num ambiente compatível com a temperatura ambiente máxima (T<sub>ma</sub>) especificada pelo fabricante.

B) Fluxo de Ar reduzido – A instalação do equipamento num bastidor deverá ser de forma a não comprometer a quantidade de ar necessária para o funcionamento seguro do mesmo.

C) Carga Mecânica – A montagem do equipamento no bastidor deverá ser de forma a evitar desequilíbrios de cargas mecânicas.

D) Sobrecarga do Circuito – Deverá ser tida em consideração a conexão do equipamento ao circuito de alimentação e o efeito que a sobrecarga dos circuitos possa ter na protecção de sobretensão e cablagem de alimentação. Deve ter-se em atenção as informações constantes na placa sinalética do equipamento, quando se abordar esta questão.

E) Ligação de Terra Fiável – Deve ser mantida uma ligação de terra fiável para o equipamento montado no bastidor. Deverá ser dada atenção particular às ligações de alimentação e não só às ligações directas ao circuito derivado (por exemplo utilização de régua de extensão).



## SUPERFÍCIE QUENTE

### Superfícies quentes externas:

Segundo com os regulamentos locais sobre saúde e segurança no local de trabalho, os fabricantes têm a obrigação de proteger os técnicos de manutenção, bem como os utilizadores. De forma a respeitar este regulamento, estes produtos deverão ter uma etiqueta que seja facilmente visível ao pessoal de assistência que aceda ao equipamento em geral, e que alerte, de forma legível, para o facto de as superfícies destes produtos poderem estar quentes, não devendo ser tocadas quando os produtos estão em funcionamento.

A unidade pode ser instalada em qualquer posição, excepto invertida (montada sobre a parte superior), ou na posição vertical, com o fluxo de ar dirigindo-se para baixo. As aberturas de ventilação destes produtos não devem ser obstruídas. Certifique-se de que existe um espaçamento de pelo menos 50 mm entre qualquer obstrução e as aberturas de ventilação.

O chassis/cobertura da unidade está concebido de forma a proteger o pessoal especializado de perigos. Não devem ser utilizados como parte das coberturas externas de qualquer equipamento em que possam estar acessíveis aos operadores, uma vez que em condições de carga máxima, algumas peças do chassis da unidade podem atingir temperaturas superiores às consideradas seguras para o acesso do operador.

# HFE1600 SERIES INSTRUCTION MANUAL

<b>CHAPTER 1:</b>	<b>HFE1600 SERIES SPECIFICATIONS</b> .....	<b>1 -</b>
	1.1 HFE1600 rated output Current and Voltage versus Line Voltage. ....	3 -
	1.2 HFE1600 Output Power vs. Temp derating.....	4 -
	1.3 HFE1600 Outline Drawing .....	5 -
	1.4 Rear Panel IN/OUT Connector Pins Function Description .....	6 -
<b>CHAPTER 2:</b>	<b>SAFETY APPROVALS</b> .....	<b>7 -</b>
	2.1 Safety Instructions.....	7 -
<b>CHAPTER 3:</b>	<b>SINGLE UNIT OPERATION</b> .....	<b>10 -</b>
	3.1 Front Panel Indicators .....	10 -
	3.2 Single unit operation .....	11 -
	3.2.1 Basic configuration (Local Sense) .....	11 -
	3.2.2 Basic configuration (Remote Sense) .....	11 -
	3.2.3 ON/OFF Control by Enable.....	12 -
	3.2.4 ON/OFF Control by INHIBIT .....	12 -
	3.2.5 Output Voltage Programming by External Voltage .....	12 -
	3.2.6 Output Voltage Programming by External Potentiometer .....	13 -
	3.2.7 SUPERVISORY Signals (Typical Connection).....	13 -
<b>CHAPTER 4:</b>	<b>POWER SUPPLIES CONNECTION</b> .....	<b>14 -</b>
	4.1 Parallel Operation .....	14 -
	4.2 Series Operation.....	15 -

**CHAPTER 1: HFE1600 SERIES SPECIFICATIONS**

HFE1600 SERIES SPECIFICATIONS:			HFE1600-12	HFE1600-24	HFE1600-32	HFE1600-48	
1	Rated output voltage	V	12	24	32	48	
2	Output voltage set point	V	12+/-1%	24+/-1%	32+/-1%	48+/-1%	
3	Output voltage range	V	9.6~13.2	19.2~29.0	25.6~38.4	38.4~58	
4	Rated Output Current at Vin ≥ 170Vac (*1)	A	133	67	47	33	
5	Rated Output Current at 100 ≤ Vin ≤ 132Vac (*1)	A	100	50	37.5	25	
6	Rated Output Current at 85V ≤ Vin < 100Vac (*1)	A	Linear derating 1% per 1Vac from output current at 100Vac.				
7	Rated output power Vin ≥ 170Vac	W	1596	1608	1504	1584	
8	Rated output power 100 ≤ Vin ≤ 132Vac	W	1200	1200	1200	1200	
9	Rated output power 85Vac ≤ Vin < 100Vac	W	Linear derating 1% per 1Vac from output power at 100Vac.				
10	Input voltage / frequency range (*2)	---	85~265Vac continuous, 47~63Hz, Single phase.				
11	Maximum input current (at 115/230Vac)	A	12.4/8.1.				
12	Power Factor (Typ.) (at 115/230Vac)	---	>0.99/0.98 at maximum output power.				
13	Efficiency at 75% rated load (Typ.) (*3)	%	87/90	88/90	88/90	89/92	
14	Efficiency at 100% rated load (Typ.) (*3)	%	87/90	87/90	87/90	88/91	
15	Inrush current (*4)	A	Less than 35.				
16	Hold-up time	mS	≥ 10mS typical at 115/230Vac input, rated output voltage and less than 80% of rated load.				
17	Maximum line regulation (*5)	%	0.25				
18	Max load regulation (*6)	%	0.50				
19	Output Ripple and noise P-P (*7)	0~+70°C	mV	240	240	320	480
		-10~0°C	mV	360	360	580	780
20	Temperature stability	---	0.05% of rated Vout for 8hrs after 30min warm-up. Constant line, load and temp.				
21	Temperature coefficient of output voltage	PPM/°C	+/-200.				
22	Remote sensing (*8)	---	Possible. Refer to Instruction Manual.				
23	Parallel operation (*9)	---	Possible. Single wire current share, 5% accuracy of rated lout, up to 10 units of the same voltage rating.				
24	Series operation	---	Possible (with external diodes), 2 units. Refer to Instruction Manual.				
25	Over current protection	85V ≤ Vin < 132Vac	---	Minimum 105% of rated output current.			
		170V ≤ Vin < 265Vac	---	105~120% of rated output current.			
26	Over voltage protection (*10)	V	Tracking OVP, range: 1.1xVout, accuracy: +/-3%, refer to Instruction Manual.				
27	Over temperature protection	---	Inverter shut down method, automatic recovery.				
28	Remote On/Off control	---	Two complementary inputs. By electrical signal or dry contact. Refer to Instruction Manual.				
29	"DC OK" signal (*13)	---	Tracking, On when Vout>90+/-5% of output voltage setting.				
30	Over-Temperature warning (*13)	---	Refer to Instruction Manual.				
31	"AC FAIL" signal (*13)	---	On when 85Vac<Vin<270Vac.				
32	Auxiliary power supply output (*11)	---	11.2~12.5V, 0.5A. 240mVp-p noise maximum.				
33	Vout programming by external voltage	---	By 0~5V, equal to Vout min ~ Vout max. Refer to Instruction Manual.				
34	Vout programming by external resistor	---	By 1Kohm potentiometer. Refer to Instruction Manual.				
35	Front panel indicators	---	AC OK, DC OK/FAIL.				
36	I <sup>2</sup> C Interface	---	Not available.				
37	Operating temperature (*15)	---	-10~+50°C: 100% load. +50°C to +60°C Derate 2%/°C of load. +60°C to +70°C Derate 2.5%/°C of load.				
38	Storage temperature	---	-30~85°C.				
39	Operating humidity	---	10~90% RH, no condensation.				
40	Storage humidity	---	10~95% RH, no condensation.				
41	Cooling	---	By internal Fans. Variable speed control based on ambient temp and power level.				
42	Vibration	---	Built to meet IEC60068-2-64 (Basic Transportation).				
43	Shock	---	Built to meet IEC60068-2-27 (Basic Transportation).				
44	Conducted emission (*14)	---	Built to meet EN55032 Class B, FCC part 15 Class-B, VCCI Class-B.				
45	Radiated emission (*14)	---	Built to meet EN55032 Class A, FCC part 15 Class-A, VCCI Class-A.				
46	Immunity	---	Built to meet IEC61000-4-2 (Level 2,3), -3 (Level 2), -4 (Level 2), -5 (Level 3,4), -6 (Level 2), -8 (Level 4), -11				
47	Applicable safety standards	---	IEC 62368-1 UL62368-1 CSA22.2 No.62368-1 EN62368-1.				
48	Withstand voltage	Input-Output:	---	3000Vrms, 1min.			
		Input-Ground:	---	2000Vrms, 1min.			
		Output - Ground:	---	500Vrms, 1min.	500Vrms, 1min.	500Vrms, 1min.	2250Vdc, 1min.
49	Isolation resistance	---	More than 100Mohm at 25°C and 70% RH. Output-Ground: 500Vdc.				
50	Leakage current (*12)	mA	Less Than 0.75/1.5 at 115/230Vac range.				
51	Weight (Typ.)	Kg	Max. 1.55.				
52	Size (W*H*D)	---	85x41x300mm. Refer to Outline Drawing.				

**Notes:**

- \*1 Refer to Figure 1.
- \*2 For cases where conformance to various safety standards (UL, EN etc.) is required, to be described as 100-240Vac (50/60Hz).
- \*3 At 115/230Vac, 25°C ambient temperature.
- \*4 Not applicable for the noise filter inrush current less than 0.2mS.
- \*5 From 85~132Vac or 170~265Vac, constant load.
- \*6 From No-load to Rated load, constant input voltage. Measured at the sensing point in Remote sense.
- \*7 Measured with JEITA-RC9131A 1:1 probe with 2x270uF electrolytic capacitors and 1uF film capacitor on the output, 20MHz B.W. When Power Supplies are installed in HFE1600-S1U shelf, measured with 1uF film capacitor on the output terminals of the HFE1600-S1U.
- \*8 Voltage drop on load wires: HFE1600-12: 0.25V/wire; HFE1600-24: 0.5V/wire; HFE1600-32: 0.75V/wire; HFE1600-48: 1V/wire.
- \*9 Accuracy applicable for load current > 50% of rated output current. Derate maximum output power by 5%.
- \*10 Inverter shut down method. Reset by AC voltage recycle or by On/Off control.
- \*11 Measured with JEITA-RC9131A 1:1 probe with 470uF electrolytic capacitor and 0.1uF film capacitor on the output, 20MHz B.W. Capacitors are not required when the Power Supply is installed in HFE1600-S1U shelf.
- \*12 Measured according to UL, EN method at 60Hz, 25°C ambient temperature.
- \*13 Open collector signal. Maximum sink current: 10mA, maximum voltage 15V.
- \*14 HFE1600 series considered as professional equipment and not intended for sale to general public.
- \*15 Refer to Output Power vs. temp derating figure A, B, C (Paragraph 1.2).

### 1.1 HFE1600 rated output Current and Voltage versus Line Voltage.

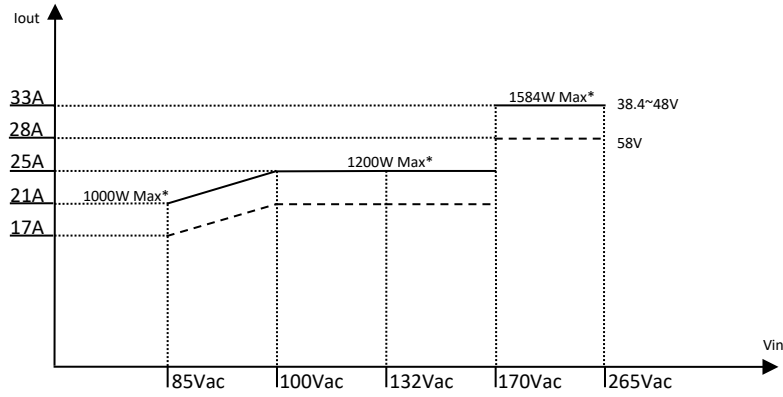

Figure 1-1: HFE1600-48

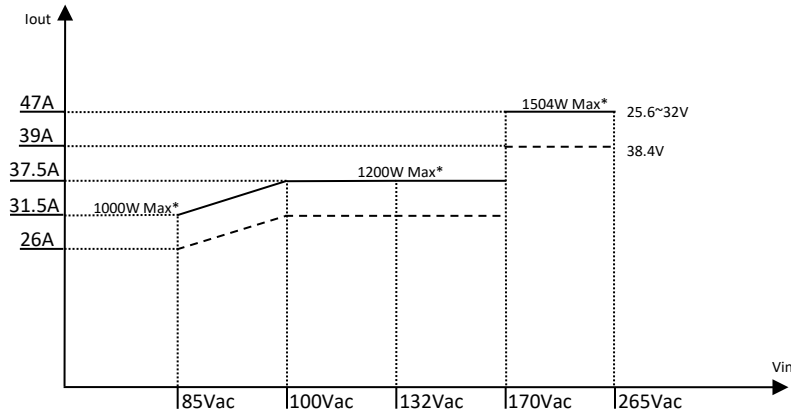

Figure 1-2: HFE1600-32

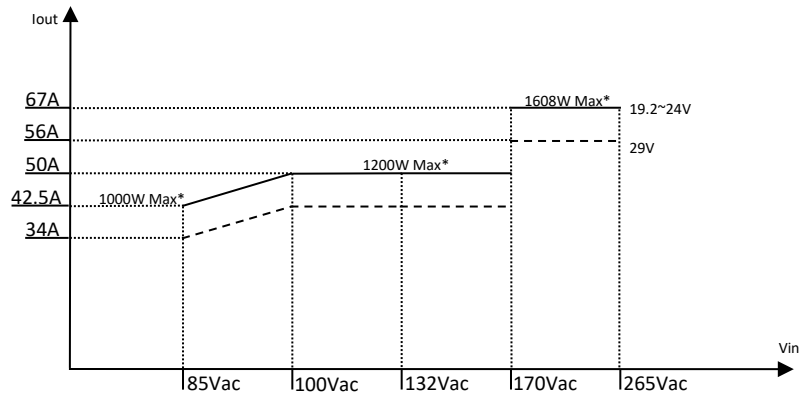

Figure 1-3: HFE1600-24

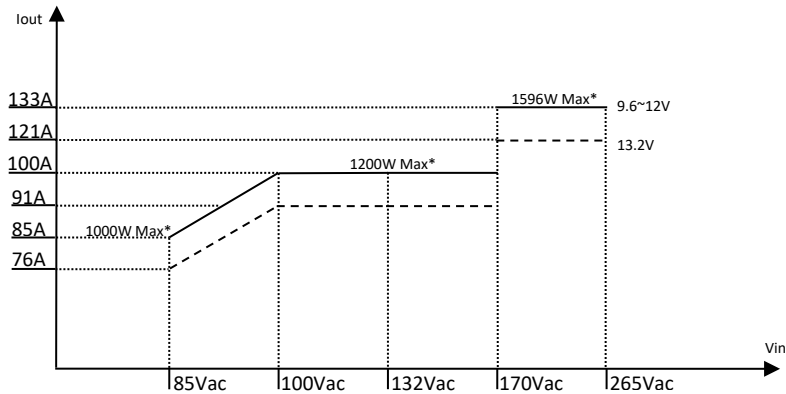

Figure 1-4: HFE1600-12



## 1.2 HFE1600 Output Power vs. Temp derating.

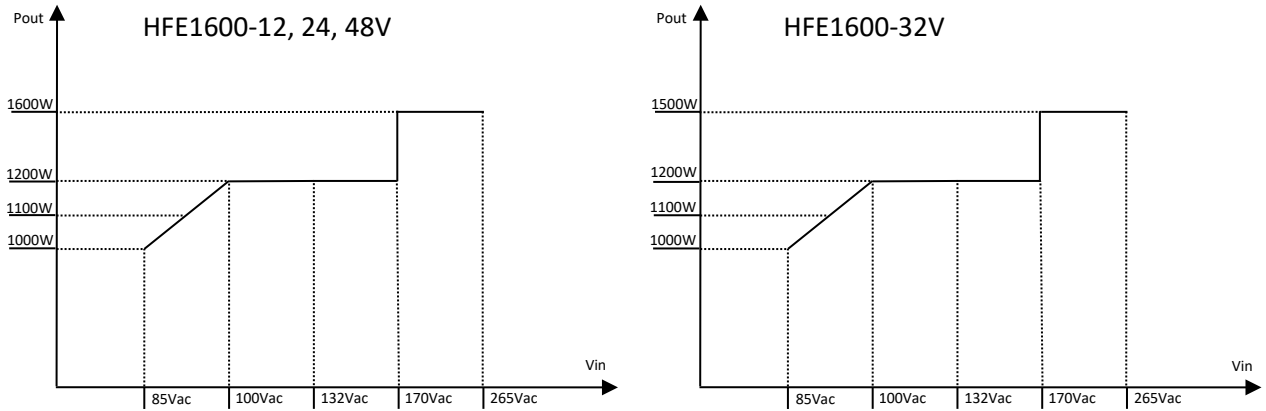

Figure 1-5: Output Power at temp -10~50°C.

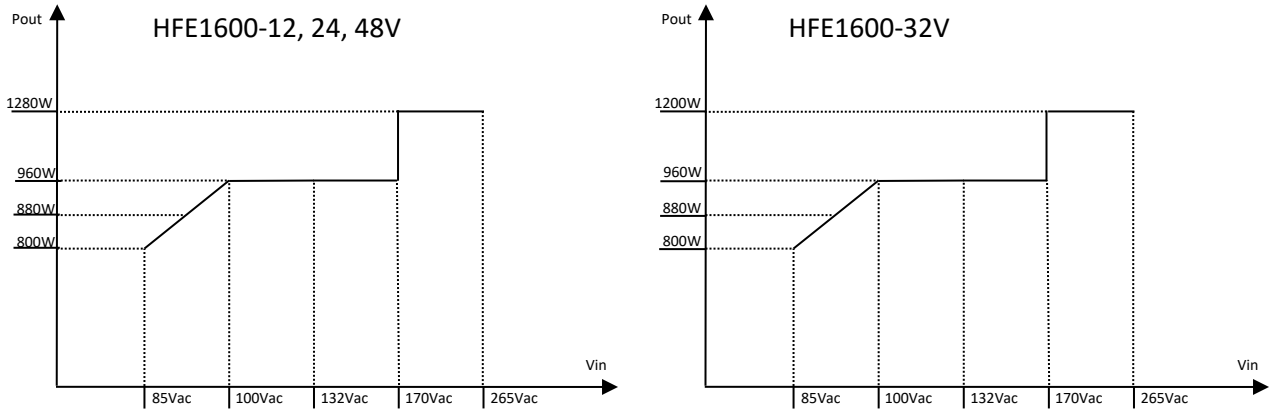

Figure 1-6: Output Power derating at temp 60°C.

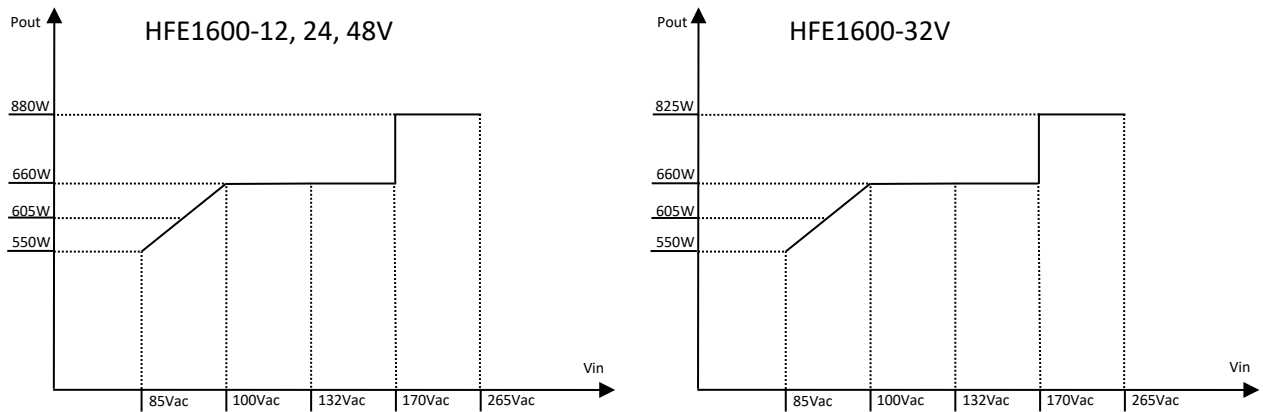
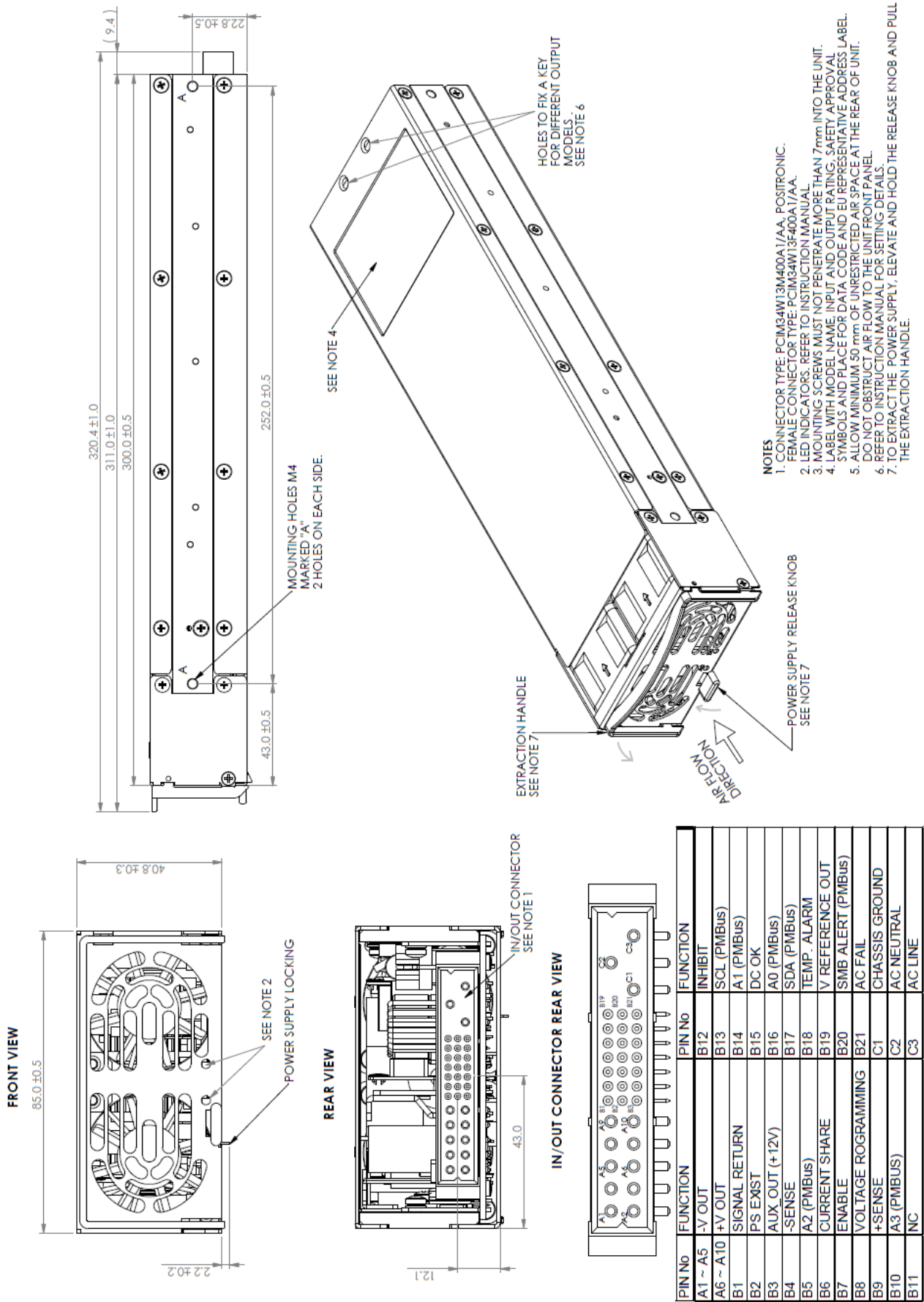

Figure 1-7: Output Power derating at temp 70°C.

### 1.3 HFE1600 Outline Drawing



## 1.4 Rear Panel IN/OUT Connector Pins Function Description

Pin #	Function	Description	Referenced to
A1~A5	-V	Main Negative Output Voltage.	
A6~A10	+V	Main Positive Output Voltage.	
B1	SIGNAL RETURN	Return for the following control signals: ENABLE, INHIBIT; Supervisory signals: TEMP ALARM, AC FAIL, AUX, DC OK and PS EXIST. PMBus signals: SCL, SDA and SMB ALERT. SIGNAL RETURN and mentioned signals are isolated from the output terminals and -SENSE.	
B2	PS EXIST	Indicates that Power Supply module is inserted into the shelf. "Active Low".	SIGNAL RETURN
B3	+12V AUX OUT	11.2 ~ 12.5V Auxiliary Voltage Output. Maximum load current is 0.5A. This output has a built in O-Ring diode. Not affected by the INHIBIT/ENABLE signal or any other fault.	SIGNAL RETURN
B4	-SENSE	Negative sense. The -SENSE signal should be connected to -V on Power Supply or Load side.	-SENSE
B5	NOT CONNECTED		-SENSE
B6	CURRENT SHARE	Current sharing signal should be connected when Power Supplies are connected in parallel, to allow accurate current share between units.	-SENSE
B7 (short pin)	ENABLE	Turns ON the main output by electrical signal or dry contact. ON: 0~0.6v or short; OFF: open.	SIGNAL RETURN
B8	VOLTAGE PROGRAMMING	Input 0~5V. Provides Vout programming by Voltage. Refer to Section 3.2.5 and Section 3.2.6.	-SENSE
B9	+SENSE	Positive sense. The +SENSE signal should be connected to +V on Power Supply or Load side.	+SENSE
B10, B11	NOT CONNECTED		
B12	INHIBIT	Turns OFF the main output by electrical signal or dry contact. OFF: 0~0.6v or short; ON: open. Requires the "ENABLE" signal to be connected to "Signal Return"	SIGNAL RETURN
B13, B14	NOT CONNECTED		SIGNAL RETURN
B15	DC OK	DC OK signal. LOW when the output voltage is higher than 90% ± 5% of set Vout. Open collector type (15V, 10mA).	SIGNAL RETURN
B16, B17	NOT CONNECTED		SIGNAL RETURN
B18	TEMPERATURE ALARM	TEMP ALARM signal. LOW when the internal temperature is within safe limit; HIGH approx. 10°C below Thermal shut down. Open collector type (15V, 10mA).	SIGNAL RETURN
B19	+5V	5V fix output voltage	-SENSE
B20	NOT CONNECTED		SIGNAL RETURN
B21	AC FAIL	AC FAIL Signal; LOW when the input voltage is 85Vac<Vin<270Vac; HIGH when the input voltage is 85Vac>Vin or Vin>270Vac. Open collector type (15V, 10mA).	SIGNAL RETURN
C1 (long pin)	PROTECTIVE GROUND	AC GROUND. Refer to Section 2.1 for Safety Instructions.	
C2 (long pin)	AC NEUTRAL	AC NEUTRAL. Refer to Section 2.1 for Safety Instructions.	
C3 (long pin)	AC LINE	AC LINE. Refer to Section 2.1 for Safety Instructions.	

Table 1-1: Rear panel IN/OUT pins

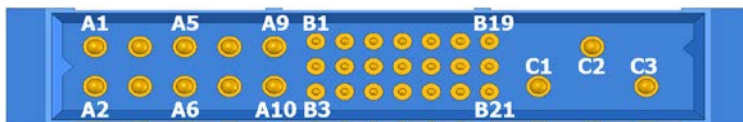

Figure 1-8: IN/OUTPUT CONNECTOR POSITRONIC P/N: PCIM34W13M400A1/AA

## CHAPTER 2: SAFETY APPROVALS

UL62368-1 and CSA22.2 No.62368-1 - UL Recognized. C-UL for Canada

IEC 62368-1 - CB Test Report and Certificate.

EN 62368-1 - TUV Mark, CE Mark.

Marking by the CE Symbol indicates compliance to the EMC Directive, the Low Voltage Directive and RoHS Directive of the European Union.

A "Declaration of Conformity" in accordance with the preceding directives and standards has been made and available on file at our EU representative TDK LAMBDA GERMANY GmbH, located at Karl-Bold-Str. 40, D-77855 Achern.

A "Declaration of Conformity" may be accessed via company website [www.emea.tdk-lambda.com/manual](http://www.emea.tdk-lambda.com/manual).

### 2.1 Safety Instructions

**CAUTION:** The following safety precaution must be observed during all phases of operation, service and repair of this equipment. Failure to comply with the safety precautions or warnings in this document violates safety standards of design, manufacture and intended use of this equipment and may impair the built-in protections within. TDK Lambda shall not be liable for user's failure to comply with these requirements.

**CAUTION:** HFE1600-xy units are not authorized for use as critical component in nuclear control systems, life support systems or equipment for use in hazardous environments without the express written approval of the managing director of TDK-Lambda.

#### POWER SYSTEM, OVERVOLTAGE CATEGORY & ENVIRONMENTAL CONDITIONS

The HFE1600-xy units have been evaluated for using in TT and IT (230VAC line - to - line) power systems.

The HFE1600-xy units have been evaluated to Overvoltage category II.

The HFE1600-xy units intended for use in the following operation conditions:

\* Indoor use                      \* Pollution degree 2                      \* Max. Operational altitude: 3000m above sea level

\*Ambient temperature: -10°C-50°C at 100% load, up to 70°C with output de-rating applied (refer to Specification above).

#### GROUNDING

HFE1600-xy units are Class I product. To minimize electrical shock hazard, the HFE1600-xy units must be connected to an electrical ground. The instruments must be connected to the AC power supply mains through a three conductor power cable, with the ground wire firmly connected to an electrical ground (safety ground) at the power outlet. For instruments designed to be hard-wired to the supply mains, the protective earth terminal must be connected to the safety electrical ground before any other connection is made. Any interruption of the protective ground conductor or disconnection of the protective earth terminal will cause a potential shock hazard that might cause personal injury.

#### LIVE CIRCUITS

Operating personnel must not remove the HFE1600-xy unit cover.

No internal adjustment or component replacement is allowed by non-TDK Lambda qualified service personnel. Never replace components with power cable connected. To avoid injuries, always disconnect power, discharge circuits and remove external voltage sources before touching components.

Restricted Access Area: HFE1600-xy units should only be installed in a Restricted Access Area. Access should be available to service personnel only.

#### PARTS SUBSTITUTIONS & MODIFICATIONS

Parts substitutions and modifications are allowed to authorized TDK Lambda service personnel only. For repairs or modifications, the instrument must be returned to TDK Lambda service facility.

#### AC INPUT

Do not connect HFE1600-xy unit to mains supply exceeding the input voltage and frequency rating. The input voltage and frequency rating is: 100-240V~, 50/60Hz. For safety reasons, the mains supply voltage fluctuations should not exceed  $\pm 10\%$  of nominal voltage.

#### HEAT HAZARD

**WARNING:** Top, bottom and side surfaces may become hot when operating the unit continuously. To reduce the risk of injury from a hot surface, allow the surface to cool before touching.

#### ENERGY HAZARD

The main output of HFE1600-xy units is capable of providing hazardous energy. Due to hazardous energy level the output and connections therefore must not be user accessible. Manufacturer's final equipment must provide protection to service personnel against inadvertent contact with output bus bars.

**FUSE**

Internal fuse is sized for fault protection and if a fuse was opened it would indicate that service is required.









Fuse replacement should be made by qualified technical personnel.

HFE1600-xy unit fuse rating is described below. F101: F20A H 250Vac.

**OVERCURRENT PROTECTION:**

A readily accessible branch circuit over-current protective device rated 30A max. Must be incorporated in the building wiring. The protective device must be disconnect both supply line simultaneously.

**SYMBOLS:**

	<p>Caution, risk of danger. Instruction manual symbol. The instrument will be marked with this symbol when it is necessary for the user to refer to the Safety &amp; Installation or Instruction manual.</p>
	<p>Indicates ground terminal.</p>
	<p>Protective earth; protective ground. Indicates the terminal which is intended for connection to an external conductor for protection against electric shock in case of a fault.</p>
	<p>Caution, risk of electric shock.</p>
	<p>Indicates the presence of a hot surface or component. Touch of a hot surface can cause injury.</p>
	<p>Direct current (DC).</p>
	<p>Alternate current (AC).</p>
	<p>Denotes hazard. A procedure requires specific attention. Not following the procedure correctly could result in a personal injury. A WARNING sign should not be skipped and all indicated conditions must be fully understood and met.</p>
	<p>Denotes hazard. A procedure requires specific attention. Not following the procedure correctly could result in damage to the equipment. Do not proceed beyond a CAUTION sign until all indicated conditions are fully understood and met.</p>

## CHAPTER 3: SINGLE UNIT OPERATION

### 3.1 Front Panel Indicators

#### 1. DC OK – LED indicator:

GREEN Output Voltage is above  $90\% \pm 5\%$  of set Output Voltage.

RED Output Voltage is below  $90\% \pm 5\%$  of set Output Voltage.

#### 2. AC OK – LED indicator:

GREEN Input Voltage ( $V_{in}$ ) is in the range of 85Vac to 270Vac.

OFF Input Voltage ( $V_{in}$ ) is below 85Vac or above 270Vac.

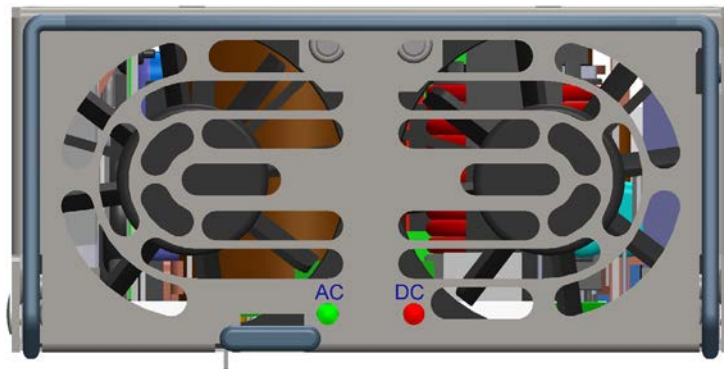

Figure 3–1: Front Panel Indicators

#### CAUTION:

When inserting a power supply into the rack, do not use unnecessary force; Slamming the power supply into the rack can damage the connectors on the rear of the supply and inside the rack.

#### ATTENTION:

Power supplies are factory programmed to the rated output voltage. For applications requiring lower / higher voltage, power supplies should be adjusted to the required voltage before connection to the load.

## 3.2 Single unit operation

### 3.2.1 Basic configuration (Local Sense)

- $\pm$  SENSE have to be connected to the HFE1600  $\pm$ V terminals prior to operating the supply.
- ENABLE input must be connected to SIGNAL RETURN in order for the supply to turn on.

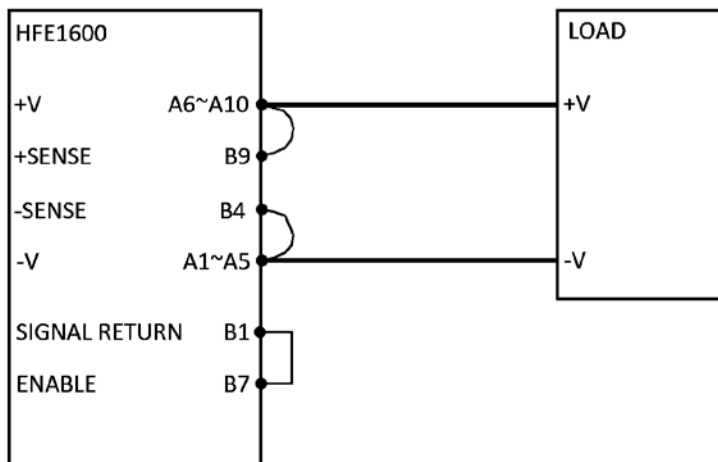

Figure 3–2: Local Sense Connection

### 3.2.2 Basic configuration (Remote Sense)

- $\pm$  SENSE have to be connected to the  $\pm$ V terminals on the Load side prior to operating the supply.
- ENABLE input must be connected to SIGNAL RETURN in order for the supply to turn on.

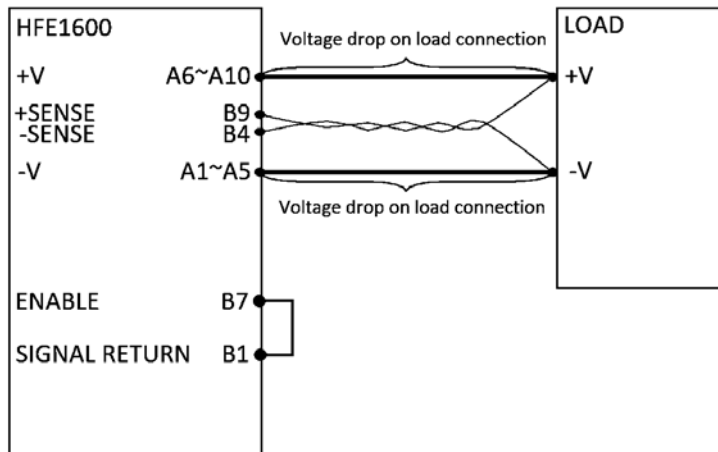

Figure 3–3: Remote Sense Connection

**ATTENTION:**

1. Maximum voltage drop on load connection:  
HFE1600-12: 0.25V/wire; HFE1600-24: 0.5V/wire; HFE1600-32: 0.75V/wire; HFE1600-48: 1V/wire.
2. Twisted wires should be used for Remote Sensing connection.
3. If Remote Sensing is used, do not break Main Output connection.



### 3.2.3 ON/OFF Control by Enable

SIGNAL RETURN and ENABLE control are isolated from the output terminals and "-SENSE".

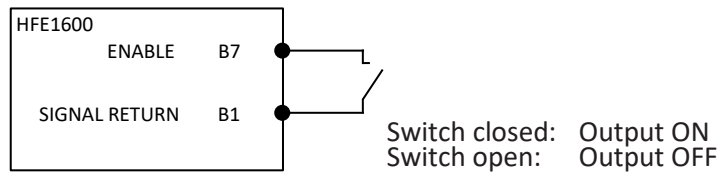

Figure 3-4: Control by ENABLE

### 3.2.4 ON/OFF Control by INHIBIT

Power Supply operation requires the "ENABLE" signal to be connected to "Signal Return".

Logic of the "INHIBIT" signal is reversed to logic of the "ENABLE" signal.

SIGNAL RETURN, INHIBIT and ENABLE controls are isolated from the output terminals and -SENSE.

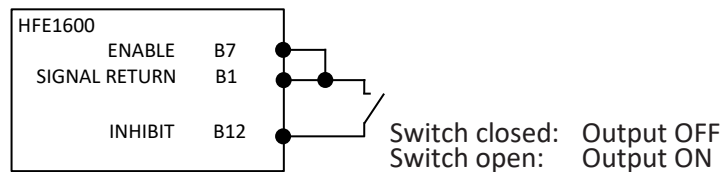

Figure 3-5: Control by INHIBIT

### 3.2.5 Output Voltage Programming by External Voltage

Output Voltage of HFE1600 Series can be programmed by external voltage source between approximately 80%-120% for 24V, 32V, 48V and 80%-110% for 12V of nominal output voltage

(For Output voltage limits see Graph enclosed).

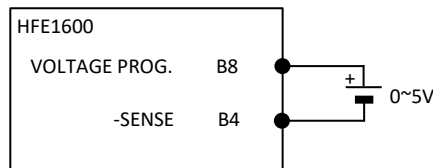

Figure 3-6: Control by Ex. Voltage

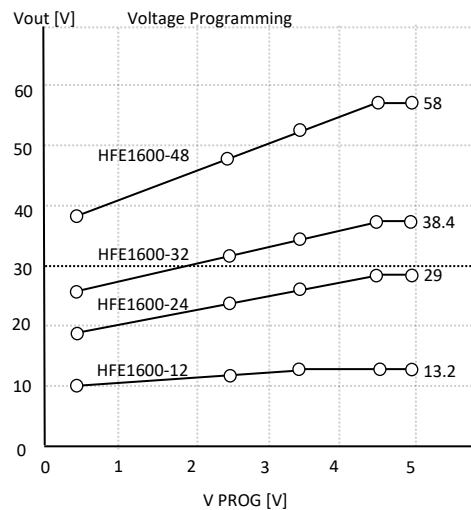

Figure 3-7: Output Voltage Limits

### 3.2.6 Output Voltage Programming by External Potentiometer

Output Voltage of HFE1600 Series can be trimmed by potentiometer between approximately 80%-120% for 24V, 32V, 48V and 80%-110% for 12V of nominal output voltage (For Output voltage limits see Graph below).

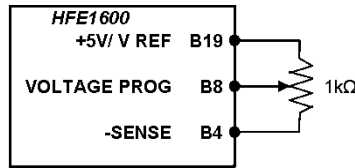

Figure 3–8: Control by Ex. Potentiometer

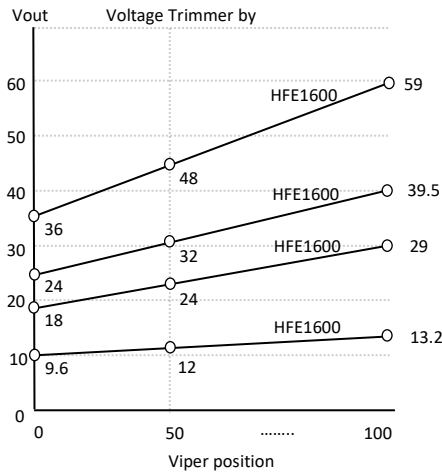

Figure 3–9: Output Voltage Limits

### 3.2.7 SUPERVISORY Signals (Typical Connection)

The following supervisory signals are accessible:

- DC OK
- AC FAIL
- PS EXIST
- TEMP ALARM

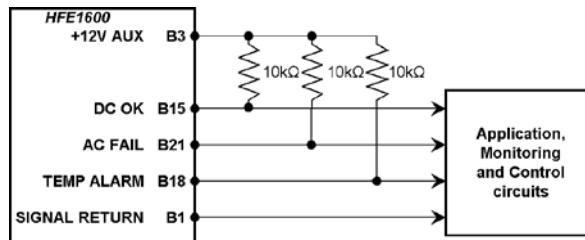

Figure 3–10: Signals

**SIGNAL RETURN** and mentioned signals are isolated from the output terminals and -SENSE.

These signals are Open Collector type (max 15V, max 10mA) shunted by internal 24V Zener, isolated from Output and referenced to "SIGNAL RETURN".

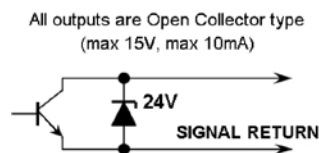
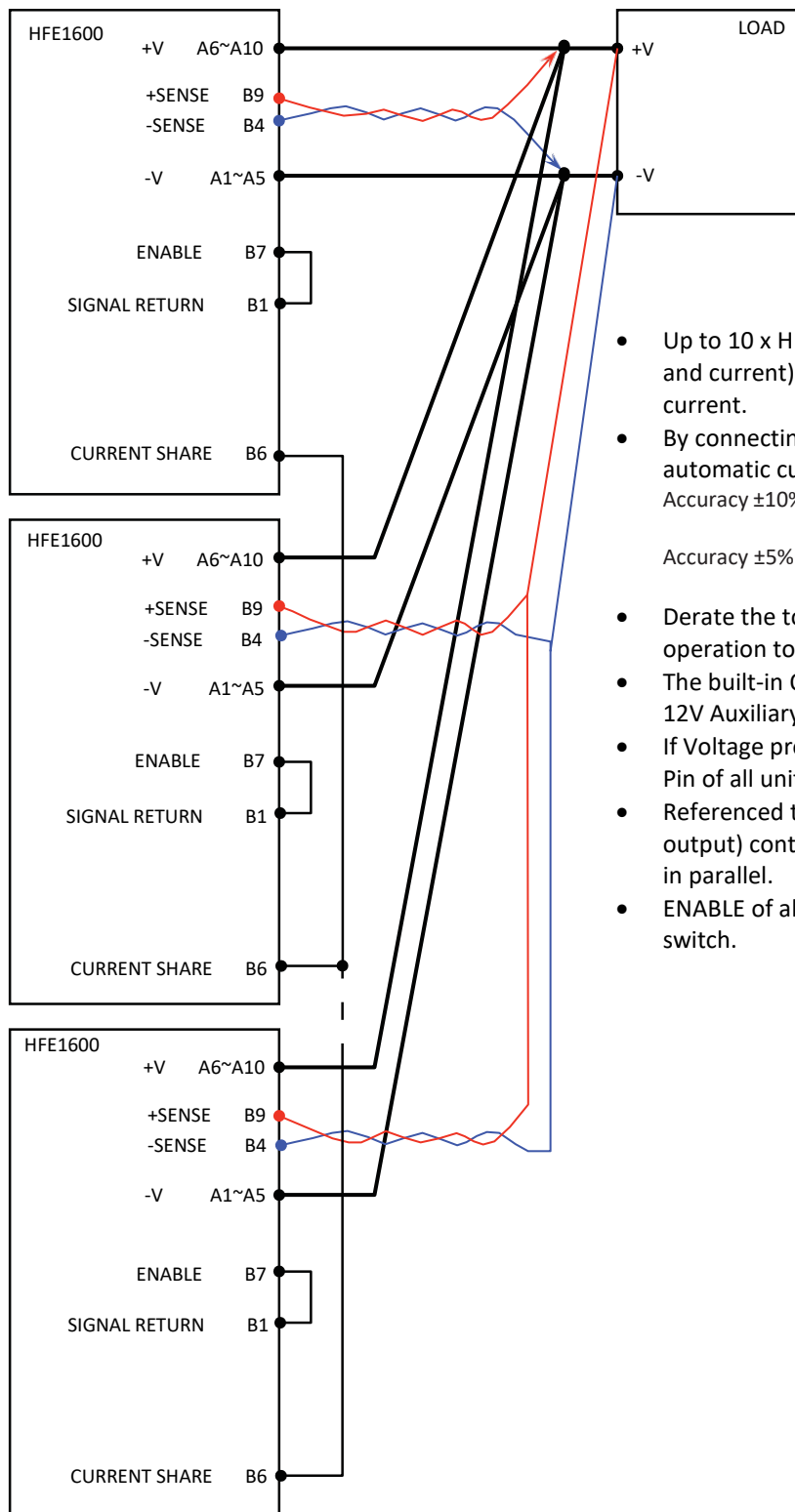

Figure 3–11: Open collector signals are shunted by internal 24V Zener

## CHAPTER 4: POWER SUPPLIES CONNECTION

### 4.1 Parallel Operation



- Up to 10 x HFE1600 units with the same rating (voltage and current) can be used in parallel to increase the output current.
- By connecting the CS signal between the paralleled units, automatic current balance is achieved with accuracy of
 

Accuracy	Load Condition
Accuracy $\pm 10\%$ :	$20\% \leq I_{out} < 50\%$ of max Iout.
	Up to 10 units
Accuracy $\pm 5\%$ :	$I_{out} \geq 50\%$ of max Iout.
	Up to 10 units.
- Derate the total output current by 5% when using parallel operation to prevent unit overload condition.
- The built-in O-Ring MOSFETs on the main output and the 12V Auxiliary output allow N+1 operation.
- If Voltage programming is used, "Voltage Programming" Pin of all units must be connected in parallel.
- Referenced to "SIGNAL RETURN" (floating from the output) controls/signals and +12V AUX can be connected in parallel.
- ENABLE of all supplies can be connected to a single switch.

Figure 4–1: Parallel Connection

## 4.2 Series Operation

- Up to 2 units with the same rating (voltage and current) can be used in series to increase the output voltage.
- Connect Main Output in series (as shown).
- Diodes should be connected in parallel with each unit output to prevent reverse voltage. Each diode should be rated to at least the power supply rated output voltage and output current.
- Connect as shown: +Sense of positive unit and –Sense of negative unit (twisted pair) to Load point, or to +V and –V accordingly for Local Sense.
- Output Voltage can be adjusted independently for each unit.
- Controls Monitoring signals and +12V AUX are referenced to “SIGNAL RETURN” and may be connected in parallel.

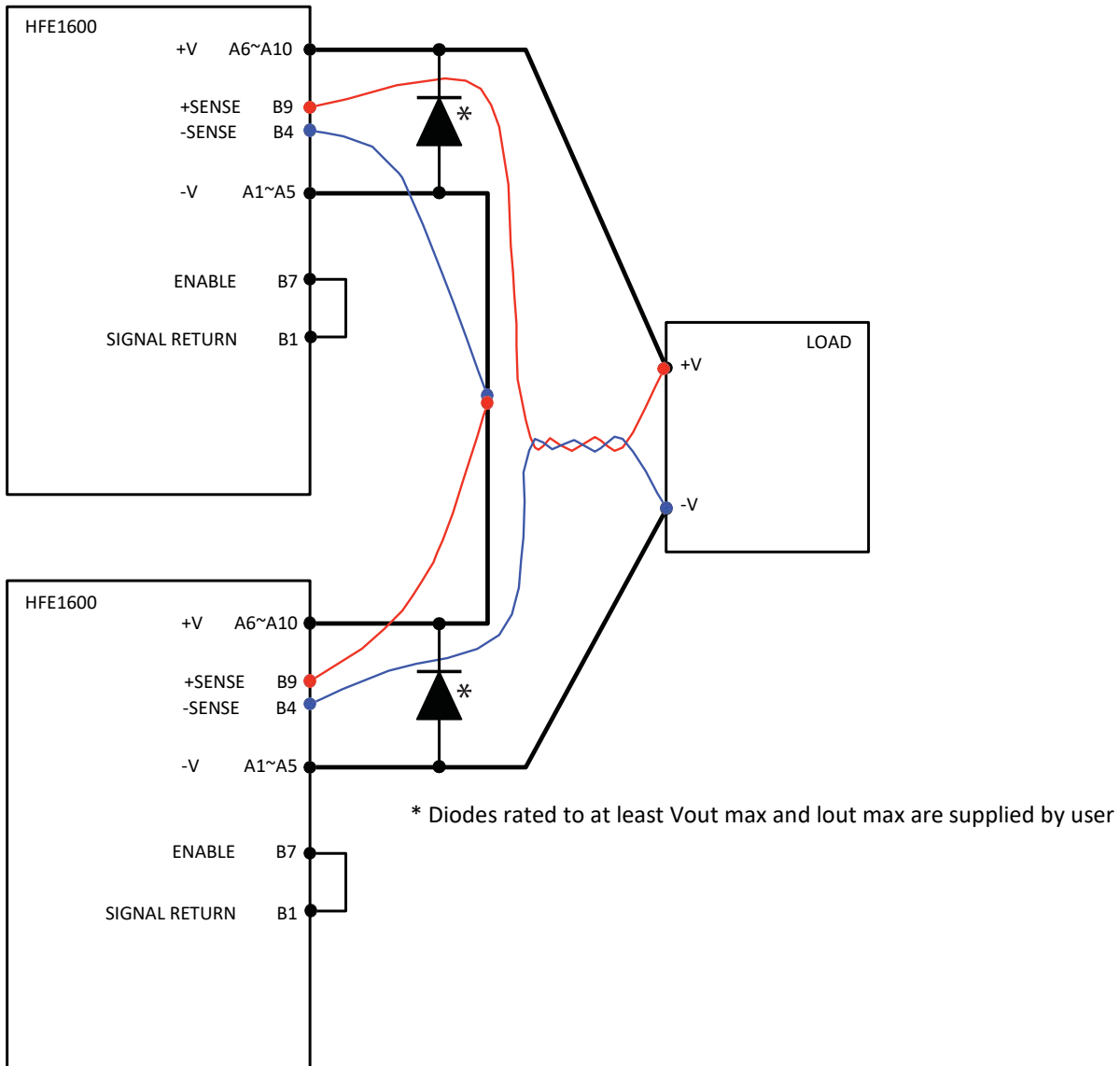

Figure 4–2: Series Connection (Remote Sense Configuration)