

EPC2108 – Enhancement-Mode GaN Power Transistor Half-Bridge with Integrated Synchronous Bootstrap

V_{DS} , 60 V

$R_{DS(on)}$, 240 mΩ

I_D , 1.7 A

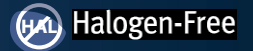

Gallium Nitride’s exceptionally high electron mobility and low temperature coefficient allows very low $R_{DS(on)}$, while its lateral device structure and majority carrier diode provide exceptionally low Q_G and zero Q_{RR} . The end result is a device that can handle tasks where very high switching frequency, and low on-time are beneficial as well as those where on-state losses dominate.

Maximum Ratings				
DEVICE	PARAMETER		VALUE	UNIT
Q1 & Q2	V_{DS}	Drain-to-Source Voltage (Continuous)	60	V
		Drain-to-Source Voltage (up to 10,000 5 ms pulses at 150°C)	72	
	I_D	Continuous ($T_A = 25^\circ\text{C}$, $R_{\theta JA} = 60^\circ\text{C/W}$)	1.7	A
		Pulsed (25°C, $T_{PULSE} = 300 \mu\text{s}$)	5.5	
	V_{GS}	Gate-to-Source Voltage	6	V
		Gate-to-Source Voltage	-4	
	T_J	Operating Temperature	-40 to 150	°C
	T_{STG}	Storage Temperature	-40 to 150	
Q3	V_{DS}	Drain-to-Source Voltage (Continuous)	100	V
		Drain-to-Source Voltage (up to 10,000 5 ms pulses at 150°C)	120	
	I_D	Continuous ($T_A = 25^\circ\text{C}$, $R_{\theta JA} = 100^\circ\text{C/W}$)	0.5	A
		Pulsed (25°C, $T_{PULSE} = 300 \mu\text{s}$)	0.5	
	V_{GS}	Gate-to-Source Voltage	6	V
		Operating Temperature	-40 to 150	
	T_J	Storage Temperature	-40 to 150	°C
	T_{STG}	Storage Temperature	-40 to 150	

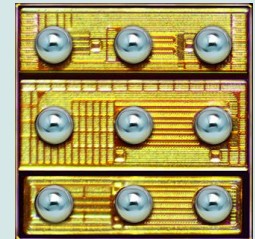

EPC2108 eGaN® ICs are supplied only in passivated die form with solder bumps
Die Size: 1.35 mm x 1.35 mm

Applications

- High Frequency DC-DC Conversion
- Class-D Audio
- Wireless Power (Highly Resonant and Inductive)

Benefits

- Ultra High Efficiency
- Ultra Low $R_{DS(on)}$
- Ultra Low Q_G
- Ultra Small Footprint

Thermal Characteristics			
PARAMETER		TYP	UNIT
$R_{\theta JC}$	Thermal Resistance, Junction-to-Case	6	°C/W
$R_{\theta JB}$	Thermal Resistance, Junction-to-Board	33	
$R_{\theta JA}$	Thermal Resistance, Junction-to-Ambient (Note 1)	81	

Note 1: $R_{\theta JA}$ is determined with the device mounted on one square inch of copper pad, single layer 2 oz copper on FR4 board. See https://epc-co.com/epc/documents/product-training/Appnote_Thermal_Performance_of_eGaN_FETs.pdf for details

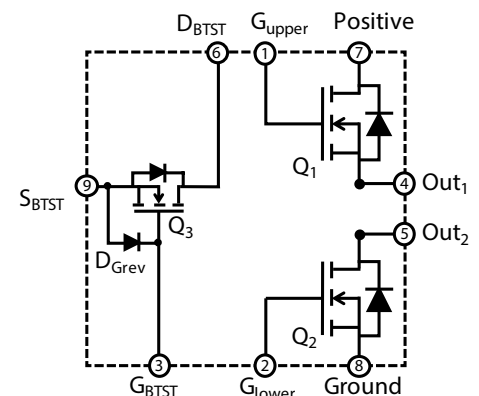

EPC2108 – Detailed Schematic

Static Characteristics ($T_J = 25^\circ\text{C}$ unless otherwise stated)

DEVICE	PARAMETER		TEST CONDITIONS	MIN	TYP	MAX	UNIT
Q1 & Q2	BV_{DSS}	Drain-to-Source Voltage	$V_{GS} = 0\text{ V}, I_D = 0.3\text{ mA}$	60			V
	I_{DSS}	Drain-Source Leakage	$V_{DS} = 48\text{ V}, V_{GS} = 0\text{ V}$		0.05	0.25	mA
	I_{GSS}	Gate-to-Source Forward Leakage	$V_{GS} = 5\text{ V}$		0.1	1	mA
		Gate-to-Source Reverse Leakage	$V_{GS} = -4\text{ V}$		0.05	0.25	mA
	$V_{GS(TH)}$	Gate Threshold Voltage	$V_{DS} = V_{GS}, I_D = 0.2\text{ mA}$	0.8	1.6	2.5	V
	$R_{DS(on)}$	Drain-Source On Resistance	$V_{GS} = 5\text{ V}, I_D = 2.5\text{ A}$		150	240	m Ω
	V_{SD}	Source-Drain Forward Voltage	$I_S = 0.5\text{ A}, V_{GS} = 0\text{ V}$		2.6		V
Q3	BV_{DSS}	Drain-to-Source Voltage	$V_{GS} = 0\text{ V}, I_D = 0.125\text{ mA}$	100			V
	I_{DSS}	Drain-Source Leakage	$V_{DS} = 80\text{ V}, V_{GS} = 0\text{ V}$		0.02	0.1	mA
	I_{GSS}	Gate-to-Source Forward Leakage	$V_{GS} = 5\text{ V}$		0.1	1	mA
	V_F	Source-Gate Forward Voltage	$I_F = 0.2\text{ mA}, V_{DS} = 0\text{ V}$			2.7	V
	$V_{GS(TH)}$	Gate Threshold Voltage	$V_{DS} = V_{GS}, I_D = 0.1\text{ mA}$	0.8	1.7	2.5	V
	$R_{DS(on)}$	Drain-Source On Resistance	$V_{GS} = 5\text{ V}, I_D = 0.05\text{ A}$		2100	3300	m Ω
	V_{SD}	Source-Drain Forward Voltage	$I_S = 0.1\text{ A}, V_{GS} = 0\text{ V}$		2.9		V

Dynamic Characteristics ($T_J = 25^\circ\text{C}$ unless otherwise stated)

DEVICE	PARAMETER		TEST CONDITIONS	MIN	TYP	MAX	UNIT
Q1	C_{ISS}	Input Capacitance	$V_{DS} = 30\text{ V}, V_{GS} = 0\text{ V}$		26	31	pF
	C_{RSS}	Reverse Transfer Capacitance			0.4		
	C_{OSS}	Output Capacitance			12	18	
	$C_{OSS(ER)}$	Effective Output Capacitance, Energy Related (Note 2)	$V_{DS} = 0\text{ to }30\text{ V}, V_{GS} = 0\text{ V}$		20		pF
	$C_{OSS(TR)}$	Effective Output Capacitance, Time Related (Note 3)			24		
	R_G	Gate Resistance			0.6		Ω
	Q_G	Total Gate Charge	$V_{DS} = 30\text{ V}, V_{GS} = 5\text{ V}, I_D = 2.5\text{ A}$		240	310	pC
	Q_{GS}	Gate to Source Charge	$V_{DS} = 50\text{ V}, I_D = 2.5\text{ A}$		106		
	Q_{GD}	Gate to Drain Charge			47		
	$Q_{G(TH)}$	Gate Charge at Threshold			71		
	Q_{OSS}	Output Charge		$V_{DS} = 30\text{ V}, V_{GS} = 0\text{ V}$		710	
Q_{RR}	Source-Drain Recovery Charge			0			
Q2	C_{ISS}	Input Capacitance	$V_{DS} = 30\text{ V}, V_{GS} = 0\text{ V}$		26	31	pF
	C_{RSS}	Reverse Transfer Capacitance			0.4		
	C_{OSS}	Output Capacitance			16	24	
	$C_{OSS(ER)}$	Effective Output Capacitance, Energy Related (Note 2)	$V_{DS} = 0\text{ to }30\text{ V}, V_{GS} = 0\text{ V}$		25		pF
	$C_{OSS(TR)}$	Effective Output Capacitance, Time Related (Note 3)			31		
	R_G	Gate Resistance			0.6		Ω
	Q_G	Total Gate Charge	$V_{DS} = 30\text{ V}, V_{GS} = 5\text{ V}, I_D = 2.5\text{ A}$		240	310	pC
	Q_{GS}	Gate to Source Charge	$V_{DS} = 30\text{ V}, I_D = 2.5\text{ A}$		106		
	Q_{GD}	Gate to Drain Charge			47		
	$Q_{G(TH)}$	Gate Charge at Threshold			71		
	Q_{OSS}	Output Charge		$V_{DS} = 30\text{ V}, V_{GS} = 0\text{ V}$		930	
Q_{RR}	Source-Drain Recovery Charge			0			
Q3	C_{ISS}	Input Capacitance	$V_{DS} = 50\text{ V}, V_{GS} = 0\text{ V}$		7	8.4	pF
	C_{RSS}	Reverse Transfer Capacitance			0.02		
	C_{OSS}	Output Capacitance			1.6	2.4	
	$C_{OSS(ER)}$	Effective Output Capacitance, Energy Related (Note 2)	$V_{DS} = 0\text{ to }50\text{ V}, V_{GS} = 0\text{ V}$		2.2		pF
	$C_{OSS(TR)}$	Effective Output Capacitance, Time Related (Note 3)			2.7		
	R_G	Gate Resistance			4.8		Ω
	Q_G	Total Gate Charge	$V_{DS} = 50\text{ V}, V_{GS} = 5\text{ V}, I_D = 0.05\text{ A}$		44	55	pC
	Q_{GS}	Gate to Source Charge	$V_{DS} = 50\text{ V}, I_D = 0.05\text{ A}$		20		
	Q_{GD}	Gate to Drain Charge			4		
	$Q_{G(TH)}$	Gate Charge at Threshold			18		
	Q_{OSS}	Output Charge		$V_{DS} = 50\text{ V}, V_{GS} = 0\text{ V}$		134	
Q_{RR}	Source-Drain Recovery Charge			0			

Note 2: $C_{OSS(ER)}$ is a fixed capacitance that gives the same stored energy as C_{OSS} while V_{DS} is rising from 0 to 50% BV_{DSS} .
 Note 3: $C_{OSS(TR)}$ is a fixed capacitance that gives the same charging time as C_{OSS} while V_{DS} is rising from 0 to 50% BV_{DSS} .

Figure 1a (Q1 & Q2): Typical Output Characteristics at 25°C

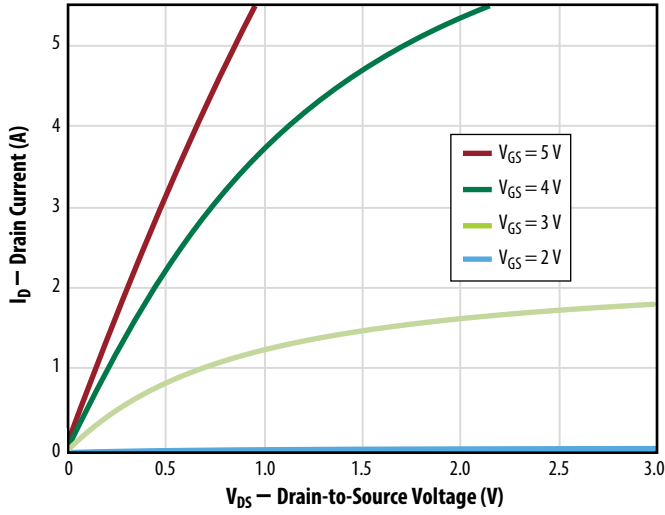

Figure 1b (Q3): Typical Output Characteristics at 25°C

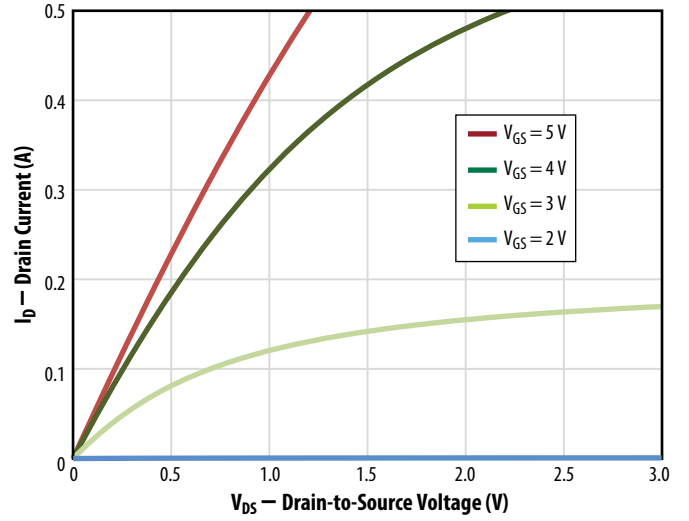

Figure 2a (Q1 & Q2): Transfer Characteristics

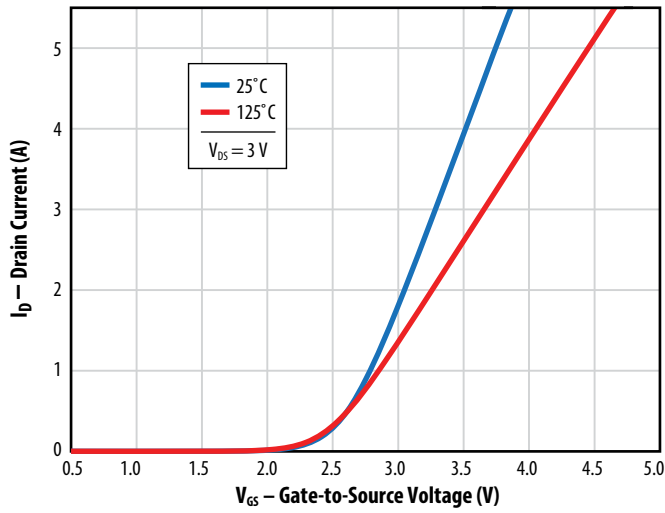

Figure 2b (Q3): Transfer Characteristics

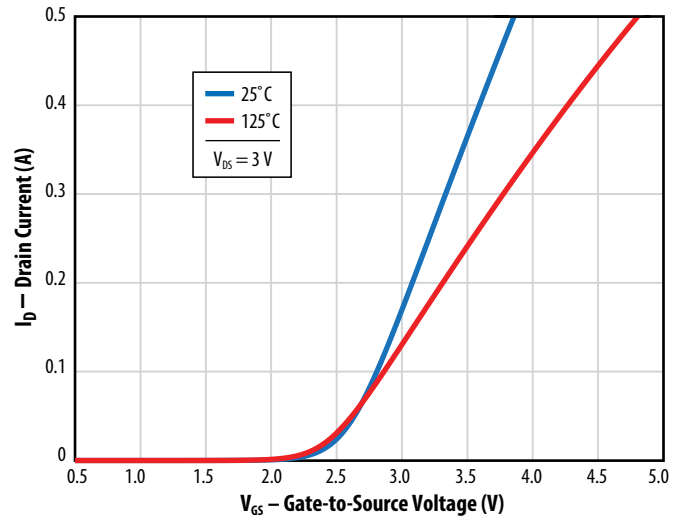

Figure 3a (Q1 & Q2): $R_{DS(on)}$ vs. V_{GS} for Various Drain Currents

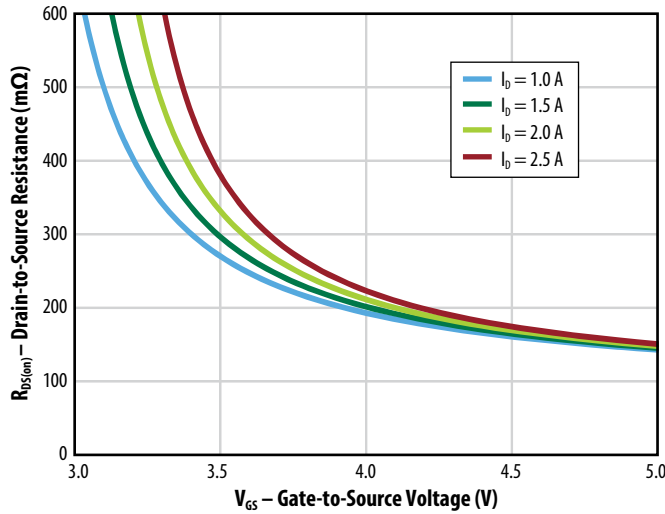

Figure 3b (Q3): $R_{DS(on)}$ vs. V_{GS} for Various Drain Currents

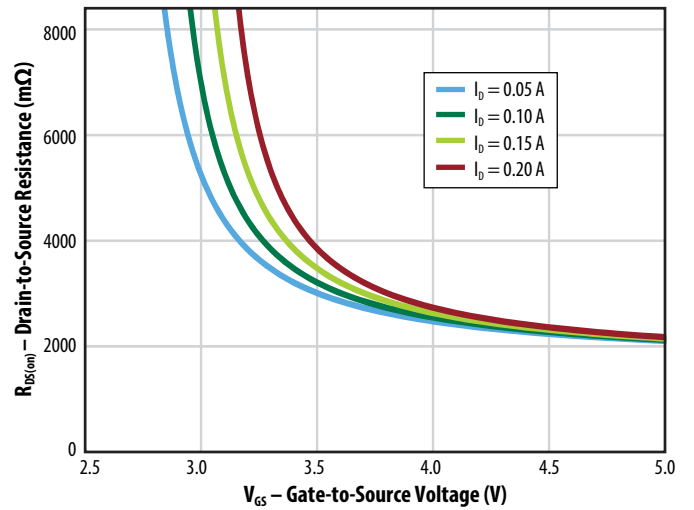

Figure 4a (Q1 & Q2): $R_{DS(on)}$ vs. V_{GS} for Various Temperatures

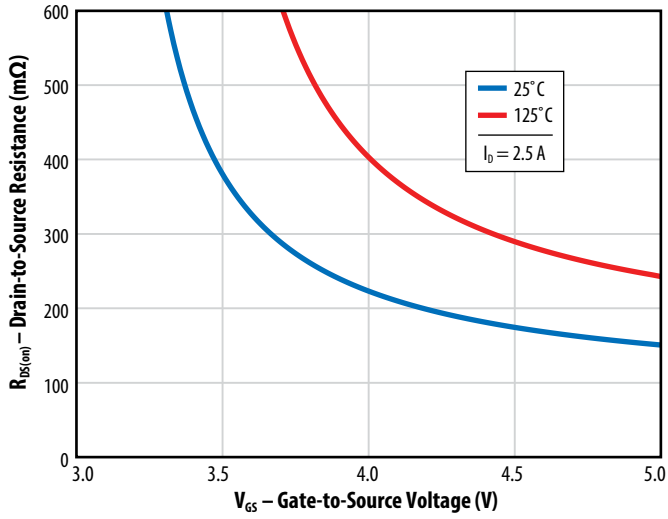

Figure 4b (Q3): $R_{DS(on)}$ vs. V_{GS} for Various Temperatures

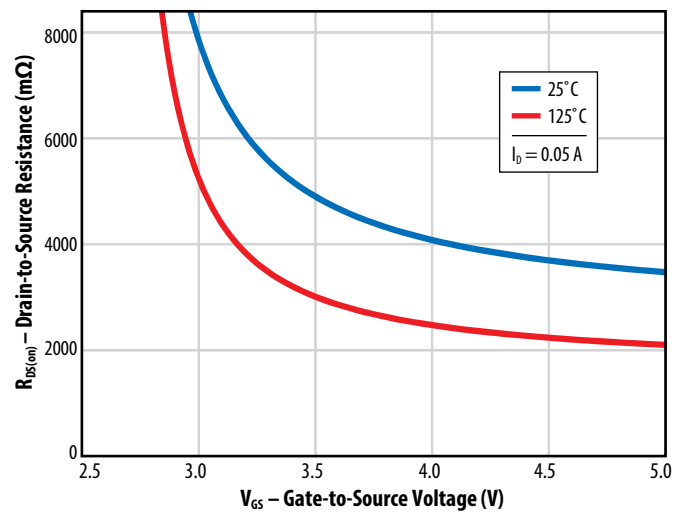

Figure 5a (Q1): Capacitance (Linear Scale)

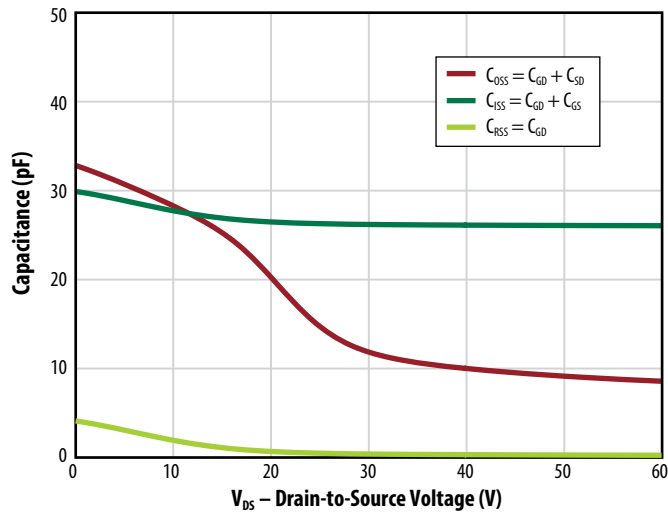

Figure 5b (Q1): Capacitance (Log Scale)

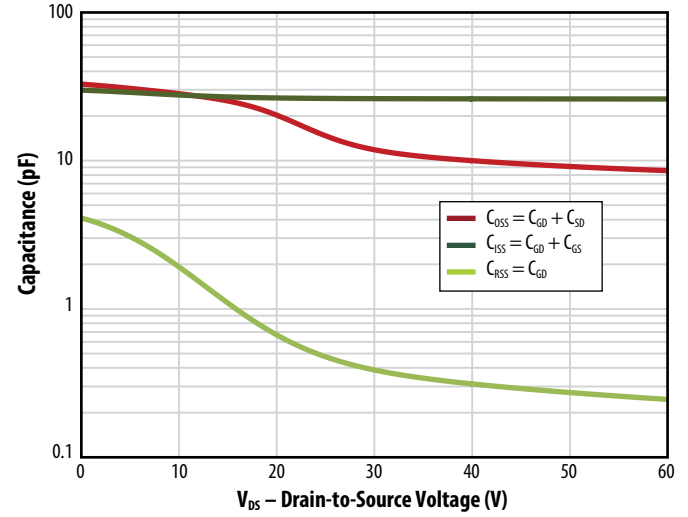

Figure 5c (Q2): Capacitance (Linear Scale)

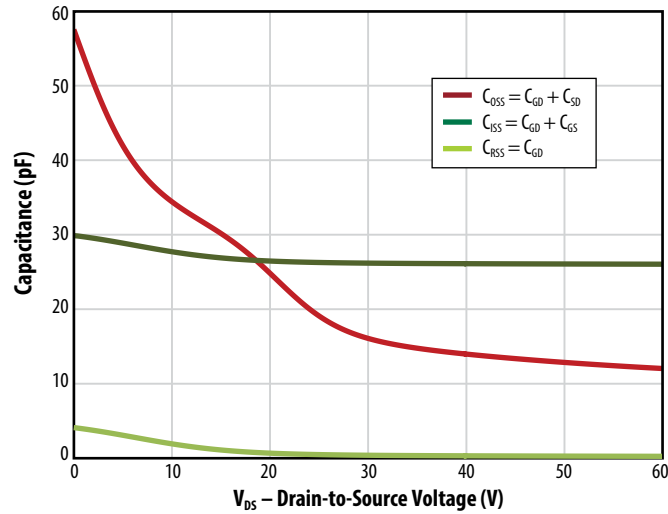

Figure 5d (Q2): Capacitance (Log Scale)

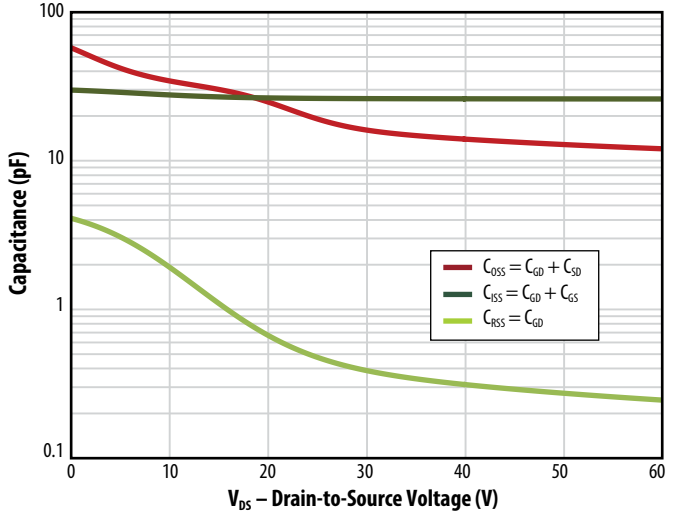

Figure 5e (Q3): Capacitance (Linear Scale)

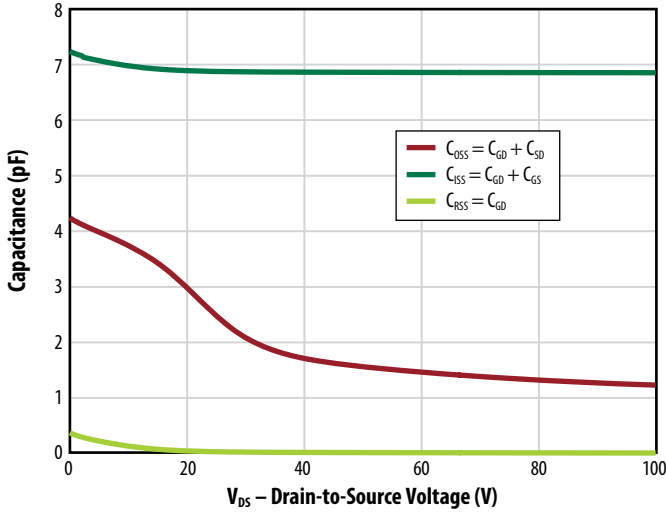

Figure 5f (Q3): Capacitance (Log Scale)

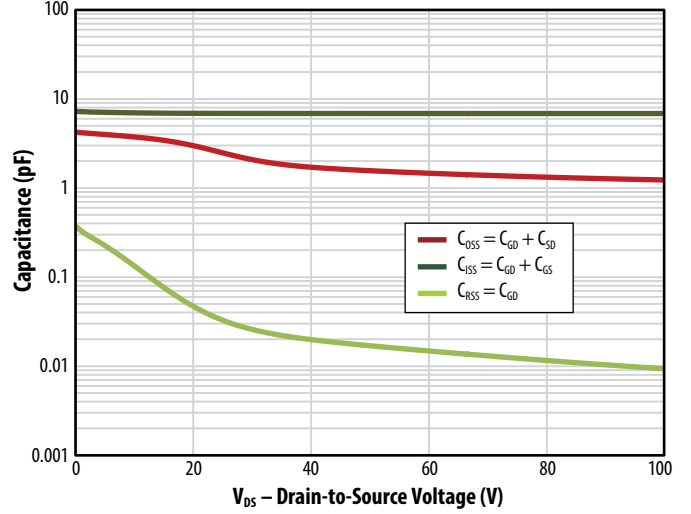

Figure 6a (Q1): Output Charge and C_{oss} Stored Energy

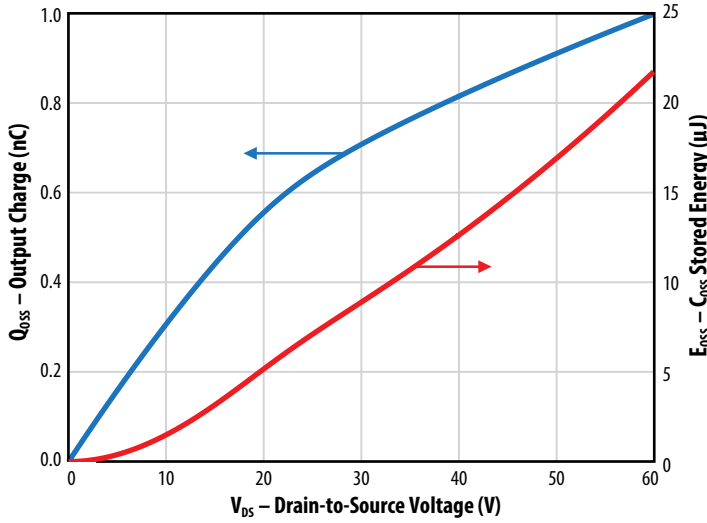

Figure 6b (Q2): Output Charge and C_{oss} Stored Energy

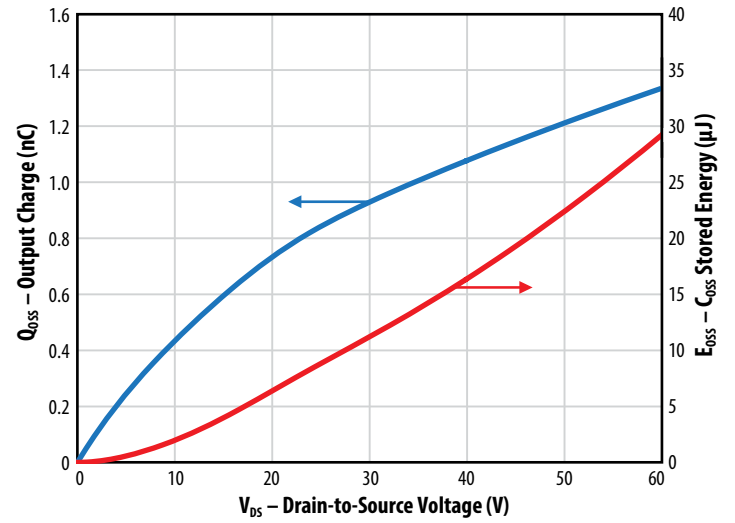

Figure 6c (Q3): Output Charge and C_{oss} Stored Energy

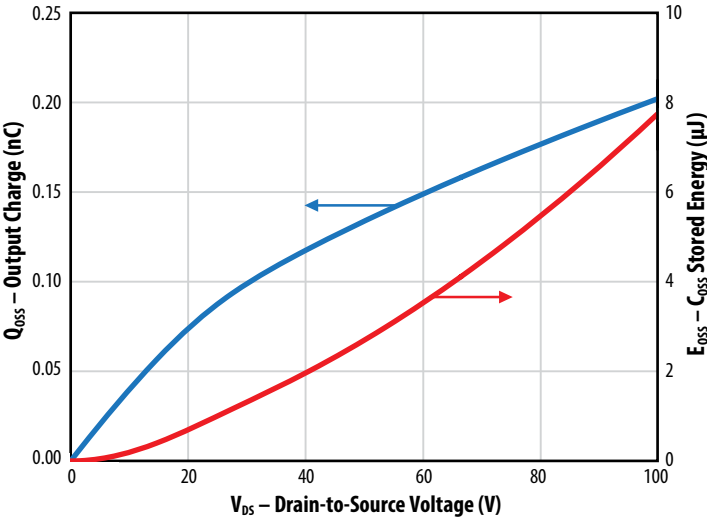

Figure 7a (Q1 & Q2): Gate Charge

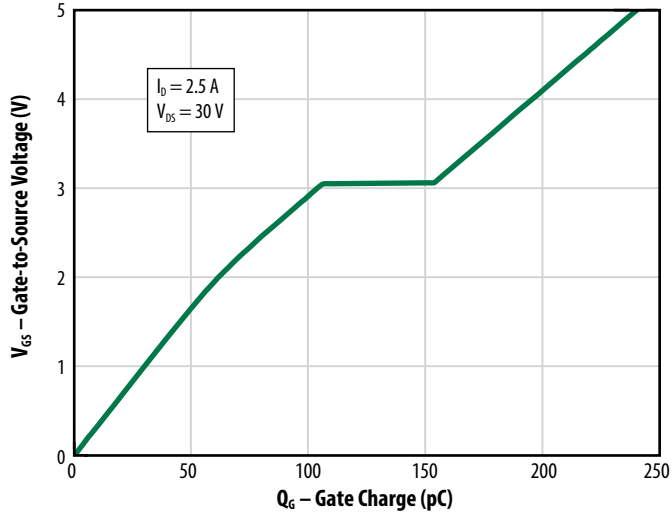

Figure 7b (Q3): Gate Charge

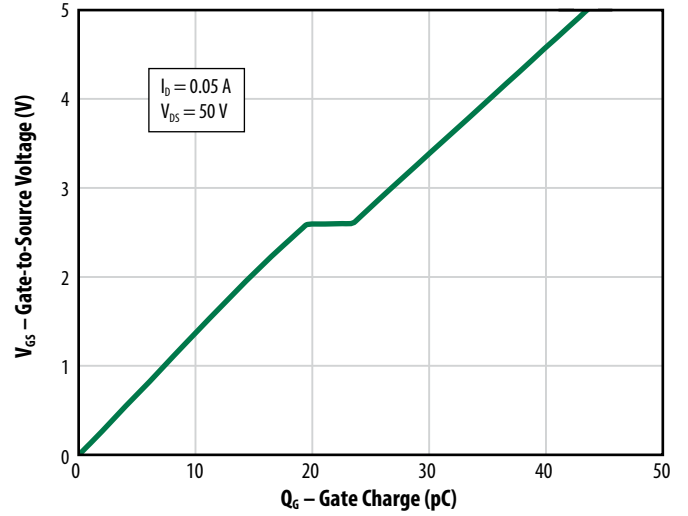

Figure 8a (Q1 & Q2): Reverse Drain-Source Characteristics

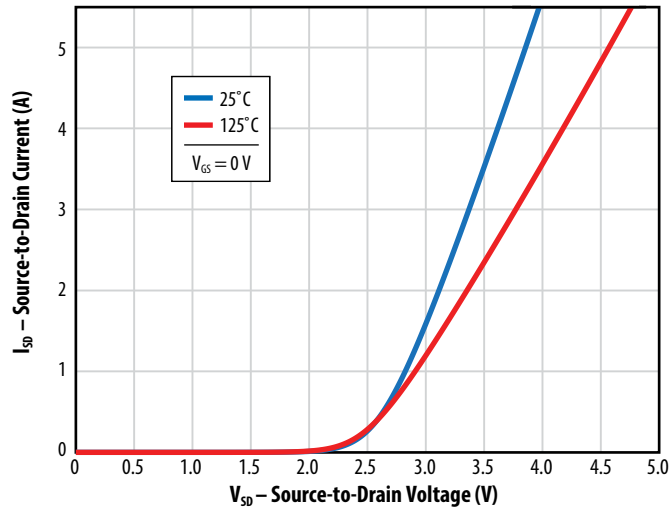

Figure 8b (Q3): Reverse Drain-Source Characteristics

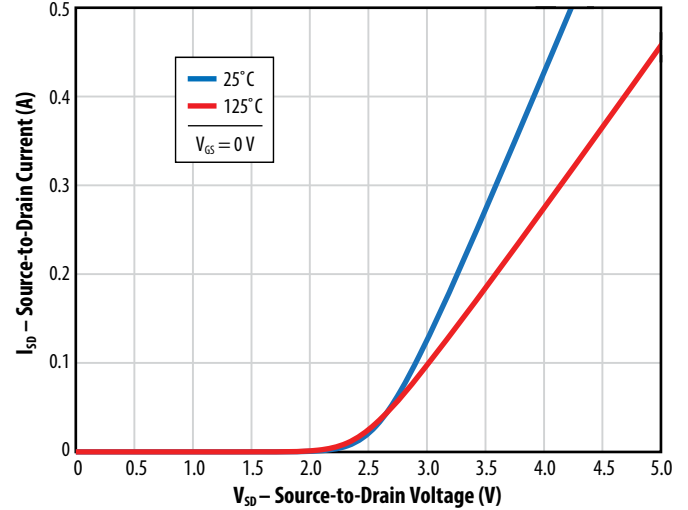

Figure 9a (Q1 & Q2):
Normalized On-State Resistance vs. Temperature

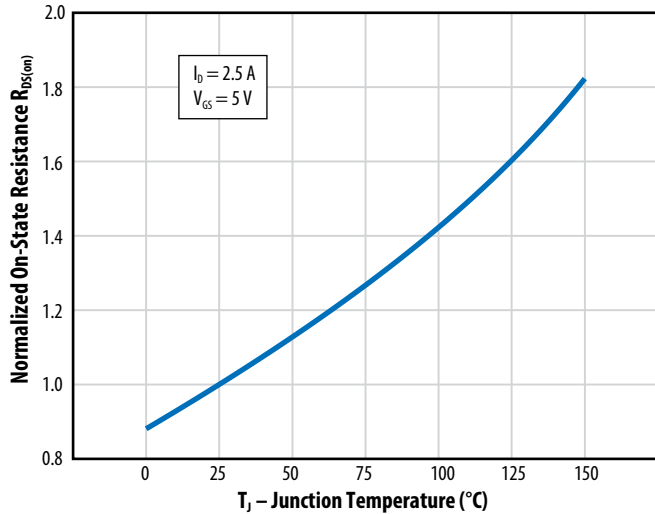

Figure 9b (Q3):
Normalized On-State Resistance vs. Temperature

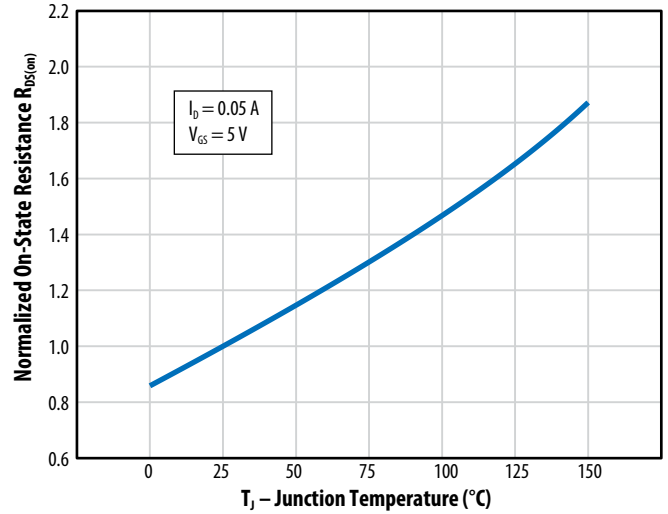

Figure 10a (Q1 & Q2):
Normalized Threshold Voltage vs. Temperature

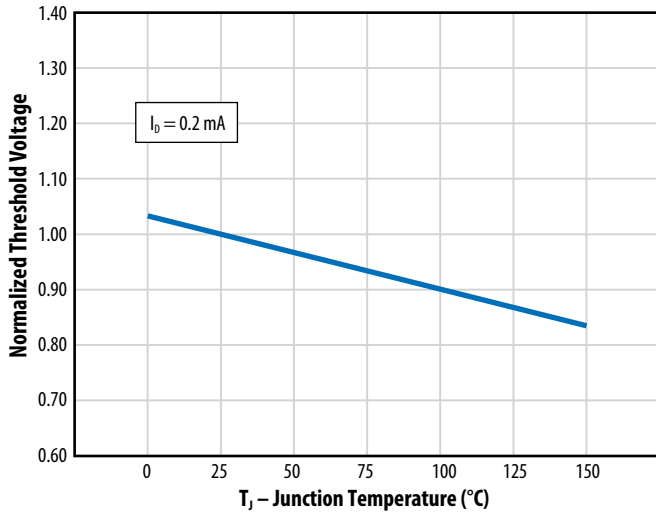

Figure 10b (Q3):
Normalized Threshold Voltage vs. Temperature

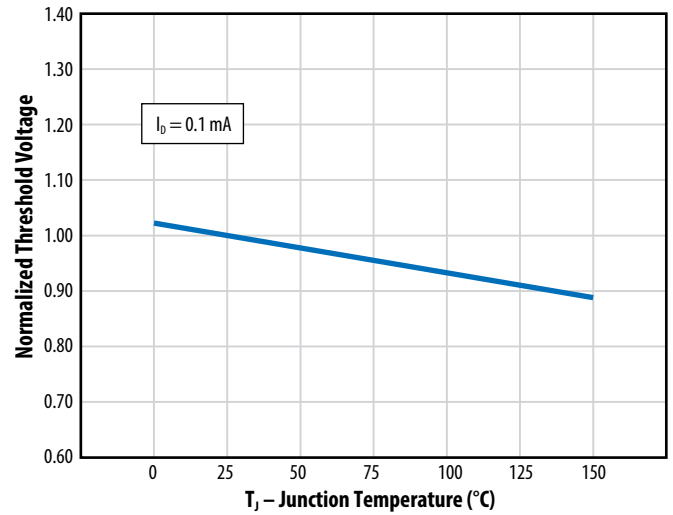

Figure 11a
Transient Thermal Response Curves

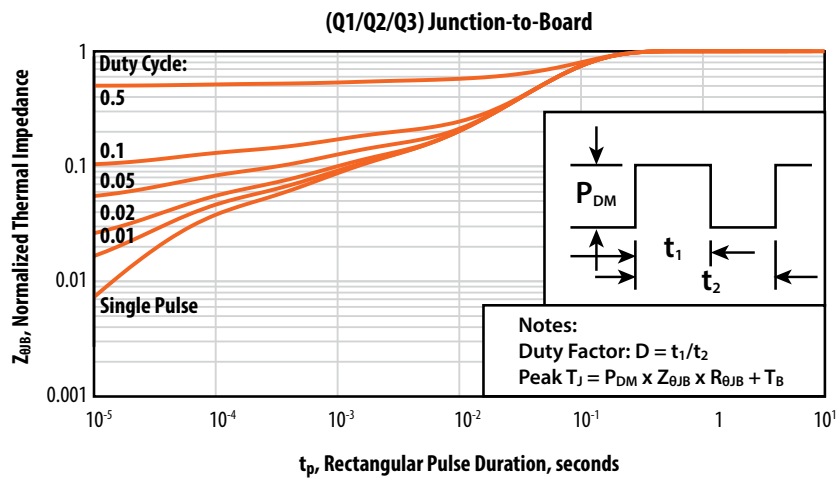

Figure 11b
Transient Thermal Response Curves

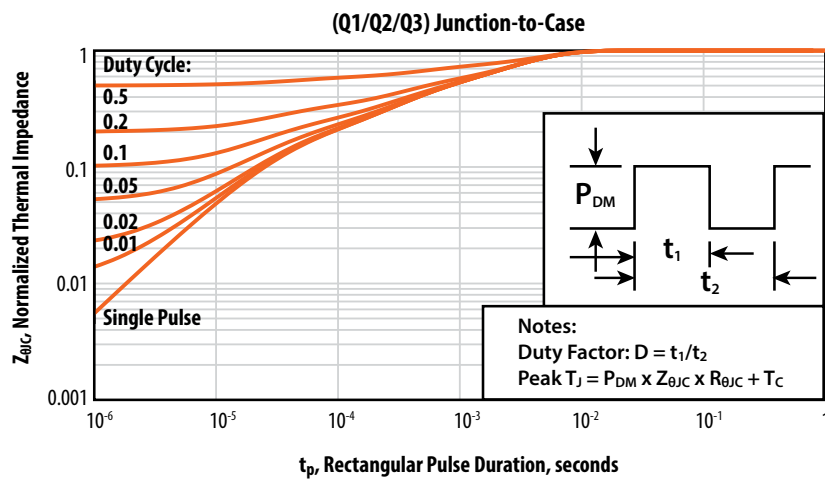

Figure 12 (Q1 & Q2): Safe Operating Area

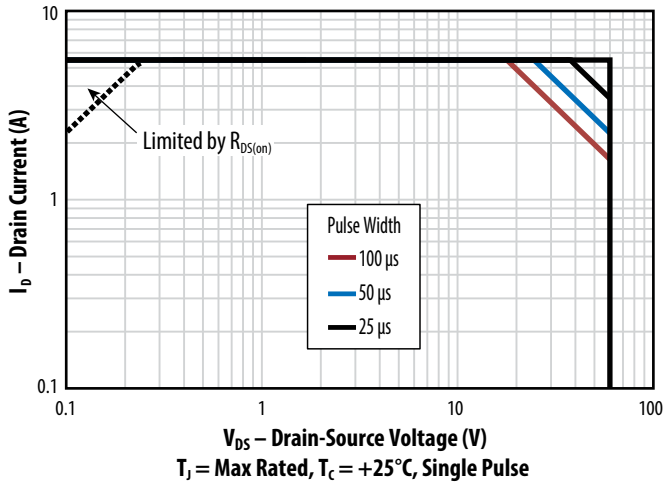

Figure 13 (Q3): Gate-Source Characteristics

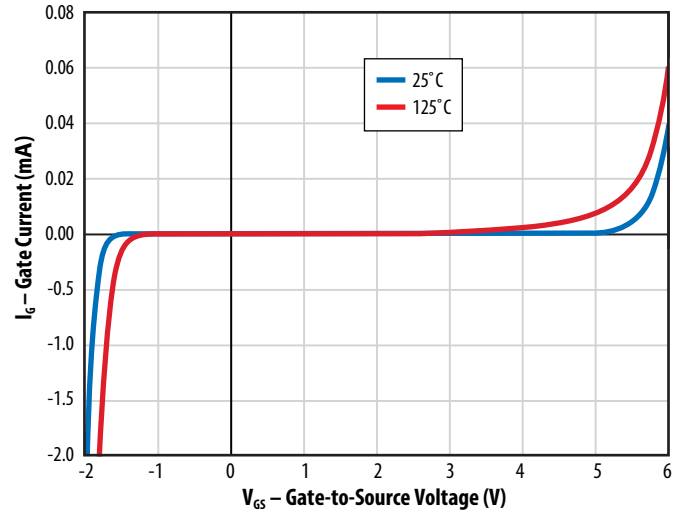
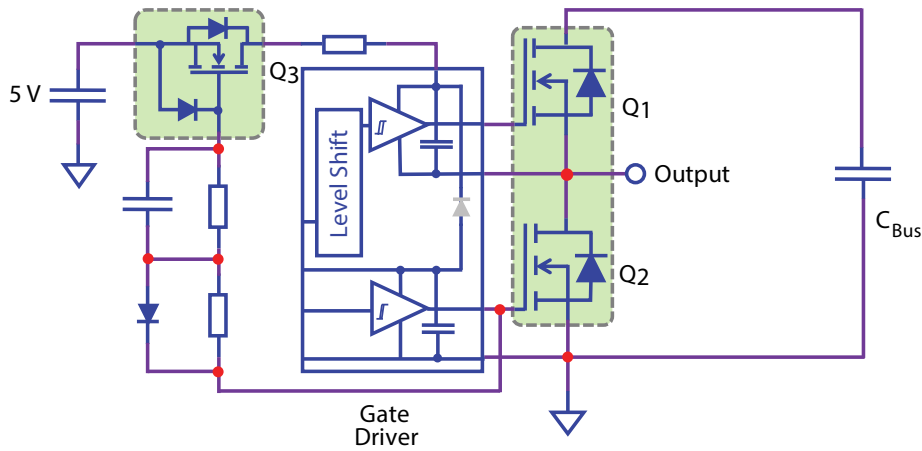
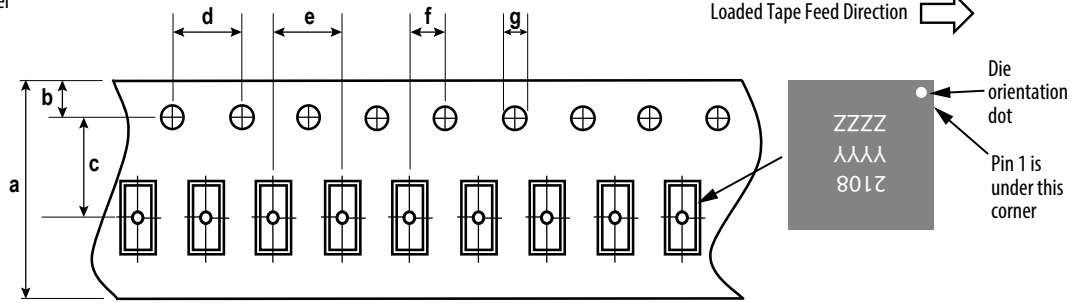
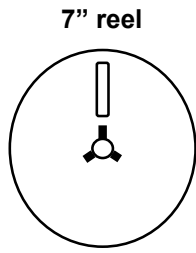

Figure 14: Typical Application Circuit



TAPE AND REEL CONFIGURATION

4mm pitch, 8mm wide tape on 7" reel



Die is placed into pocket solder bump side down (face side down)

Dimension (mm)	EPC2108 (note 1)		
	target	min	max
a	8.00	7.90	8.30
b	1.75	1.65	1.85
c (see note)	3.50	3.45	3.55
d	4.00	3.90	4.10
e	4.00	3.90	4.10
f (see note)	2.00	1.95	2.05
g	1.5	1.5	1.6

Note 1: MSL 1 (moisture sensitivity level 1) classified according to IPC/JEDEC industry standard.
 Note 2: Pocket position is relative to the sprocket hole measured as true position of the pocket, not the pocket hole.

DIE MARKINGS

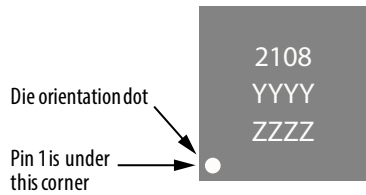

Part Number	Laser Markings		
	Part # Marking Line 1	Lot_Date Code Marking Line 2	Lot_Date Code Marking Line 3
EPC2108	2108	YYYY	ZZZZ

DIE OUTLINE
Solder Bump View

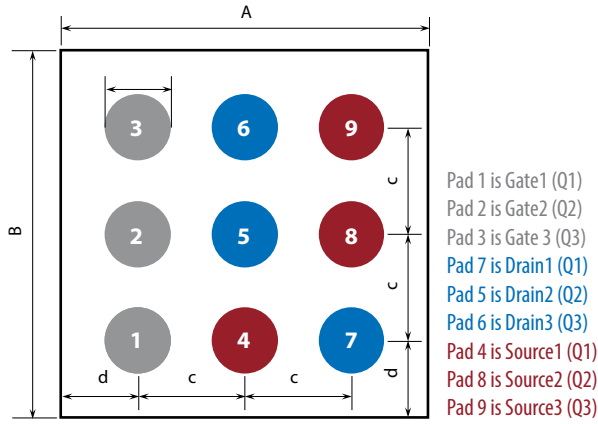

DIM	Micrometers		
	MIN	Nominal	MAX
A	1320	1350	1380
B	1320	1350	1380
c	450	450	450
d	210	225	240
e	187	208	229

Side View

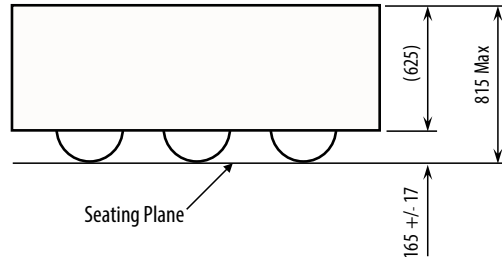

RECOMMENDED LAND PATTERN
(measurements in μm)

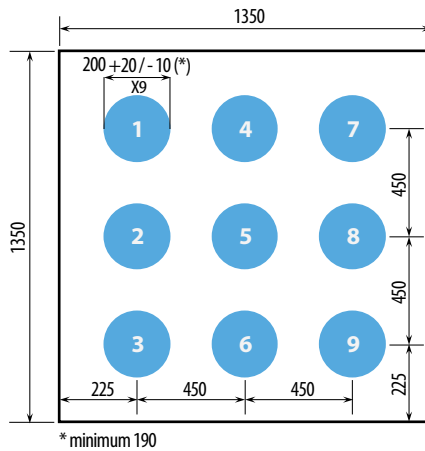

The land pattern is solder mask defined
Solder mask is 10 μm smaller per side than bump

RECOMMENDED STENCIL DRAWING
(measurements in μm)

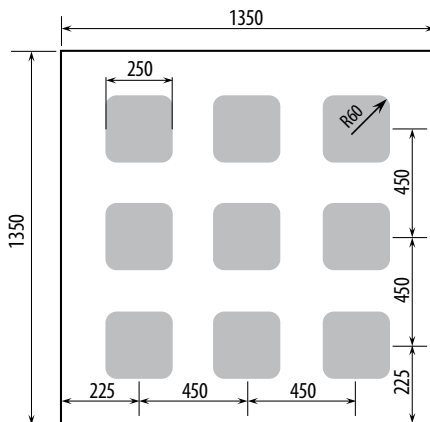

Recommended stencil should be 4 mil (100 μm) thick, must be laser cut, openings per drawing.

Intended for use with SAC305 Type 4 solder, reference 88.5% metals content.

Additional assembly resources available at
<https://epc-co.com/epc/DesignSupport/AssemblyBasics.aspx>

Efficient Power Conversion Corporation (EPC) reserves the right to make changes without further notice to any products herein to improve reliability, function or design. EPC does not assume any liability arising out of the application or use of any product or circuit described herein; neither does it convey any license under its patent rights, nor the rights of others.

eGaN® is a registered trademark of Efficient Power Conversion Corporation.
EPC Patent Listing: epc-co.com/epc/AboutEPC/Patents.aspx

Information subject to change without notice.

Revised August, 2019