

2.8V TVS Array For ESD and Latch-Up Protection

Description

The SLVU2.8-4.TBT is designed to protect low voltage, CMOS semiconductors from transients caused by electrostatic discharge(ESD), cable discharge events(CDE), lightning and other induced voltage surges. Low capacitance compensation diode is integrated into the TVS to lower the typical capacitance to 6pF per line. The SLVU2.8-4 complies with the IEC 61000-4-2 (ESD) standard with $\pm 30\text{kV}$ air and $\pm 30\text{kV}$ contact discharge. The SLVU2.8-4.TBT is assembled into a 8-pin lead-free SO-8 package. The combination of low leakage, signal integrity and flow through design makes the SLVU2.8-4.TBT an ideal application such as 10/100/1000 Ethernet.

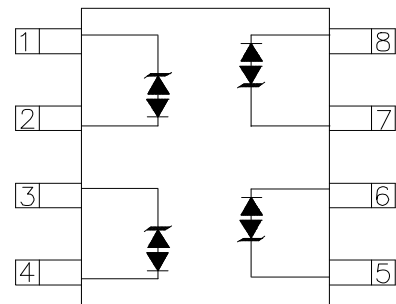

Circuit and Pin Schematic

Mechanical Characteristics

- ◆ Package: SOP-8
- ◆ Lead Finish: Matte Tin
- ◆ Case Material: "Green" Molding Compound.
- ◆ UL Flammability Classification Rating 94V-0
- ◆ Moisture Sensitivity: Level 3 per J-STD-020
- ◆ Terminal Connections: See Diagram Below
- ◆ Marking Information: See Below

Applications

- ◆ Base Station
- ◆ Analog Inputs
- ◆ Switch Systems
- ◆ 10/100/1000 Ethernet
- ◆ WAN/LAN Equipment
- ◆ Desktops, Servers, and Notebooks
- ◆ Low Voltage Interfaces

Features

- ◆ 100W peak pulse power(8/20 μs)
- ◆ Protects two line pairs(four lines)
- ◆ Ultra low leakage: nA level
- ◆ Low operating voltage: 2.8V
- ◆ Low capacitance
- ◆ Ultra low clamping voltage
- ◆ JEDEC SO-8 package
- ◆ Complies with following standards:
 - IEC 61000-4-2 (ESD) immunity test
 - Air discharge: $\pm 30\text{kV}$
 - Contact discharge: $\pm 30\text{kV}$
 - IEC61000-4-4 (EFT) 40A (5/50ns)
 - IEC61000-4-5 (Lightning) 10A (8/20 μs)
- ◆ RoHS Compliant

2.8V TVS Array For ESD and Latch-Up Protection
Absolute Maximum Ratings ($T_A=25^{\circ}\text{C}$ unless otherwise specified)

Parameter	Symbol	Value	Unit
Peak Pulse Power(8/20 μs)	Ppk	100	W
Peak Pulse Current(8/20 μs)	I _{PP}	10	A
ESD per IEC 61000-4-2 (Air)	V _{ESD}	± 30	kV
ESD per IEC 61000-4-2 (Contact)		± 30	
Operating Temperature Range	T _J	-40 to +125	$^{\circ}\text{C}$
Storage Temperature Range	T _{stg}	-55 to +150	$^{\circ}\text{C}$

Electrical Characteristics ($T_A=25^{\circ}\text{C}$ unless otherwise specified)

Parameter	Symbol	Min	Typ	Max	Unit	Test Condition
Reverse Working Voltage	V _{RWM}			2.8	V	
Punch-Through Voltage	V _{PT}	3.5	3.8	4.3	V	I _{PT} = 2 μA
Snap-Back Voltage	V _{SB}	2.8				I _{SB} = 50mA
Reverse Leakage Current	I _R			1.0	μA	V _{RWM} = 2.8V
Clamping Voltage	V _C			5.5	V	I _{PP} = 1A (8 x 20 μs pulse)
Clamping Voltage	V _C			10	V	I _{PP} = 10A (8 x 20 μs pulse)
Variation in capacitance with reverse bias			1.3		pF	Pins 1,8 to 2,7 and pins 3,6 to 4,5 V _R = 0 to 2.8V, f = 1MHz
Junction Capacitance	C _J		4.5	6	pF	Pins 1,8 to 2,7 and pins 3,6 to 4,5 V _R = 2.8V, f = 1MHz

2.8V TVS Array For ESD and Latch-Up Protection

Typical Performance Characteristics (T_A=25°C unless otherwise Specified)

Non-Repetitive Peak Pulse Power vs. Pulse Time

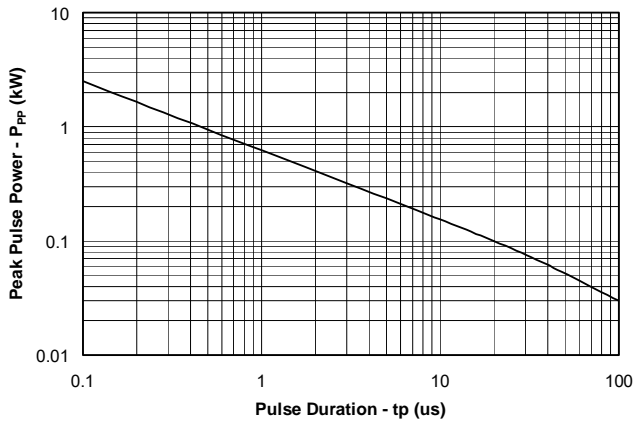

Clamping Voltage vs. Peak Pulse Current

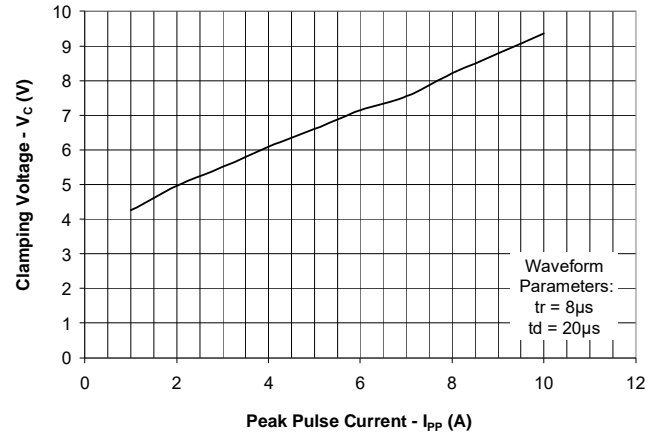

Normalized Junction Capacitance vs. Reverse Voltage

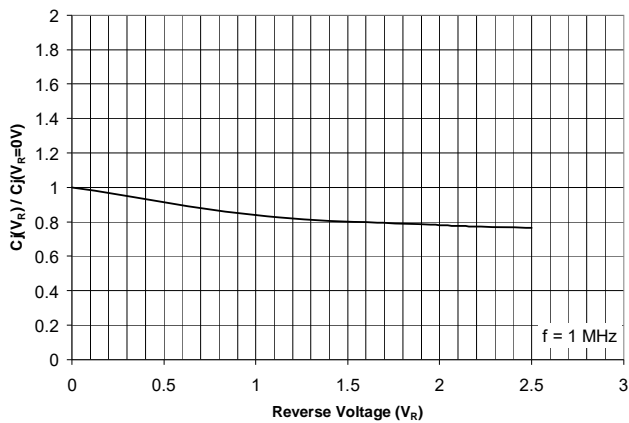

Typical Insertion Loss (S21)

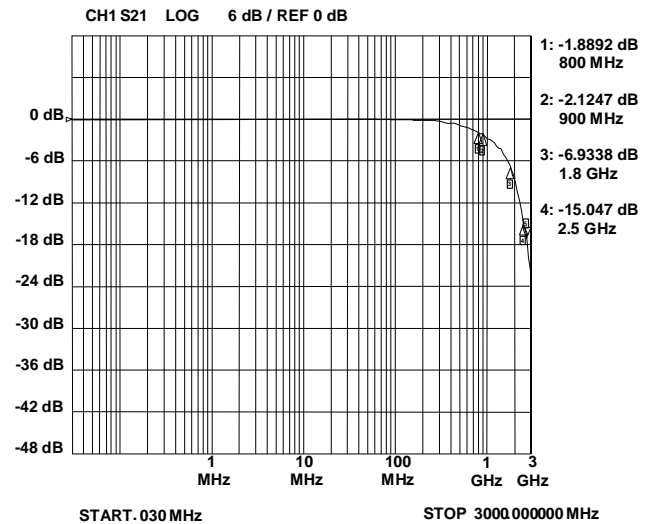

ESD Clamping (8kV Contact per IEC 61000-4-2)

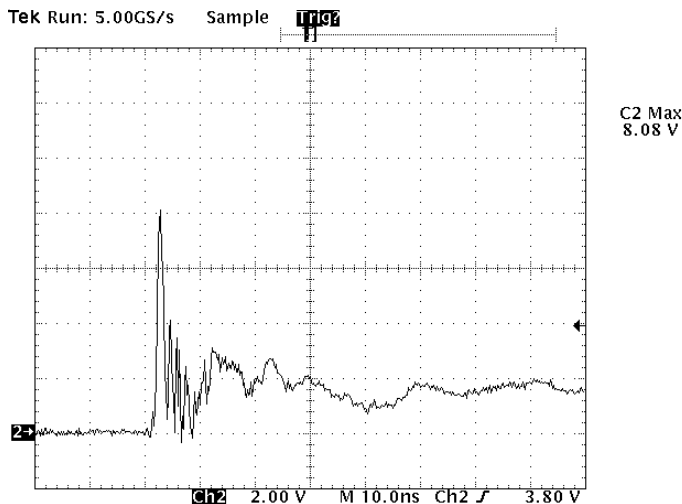

Note: Data is taken with a 10x attenuator

ESD Clamping (-8kV Contact per IEC 61000-4-2)

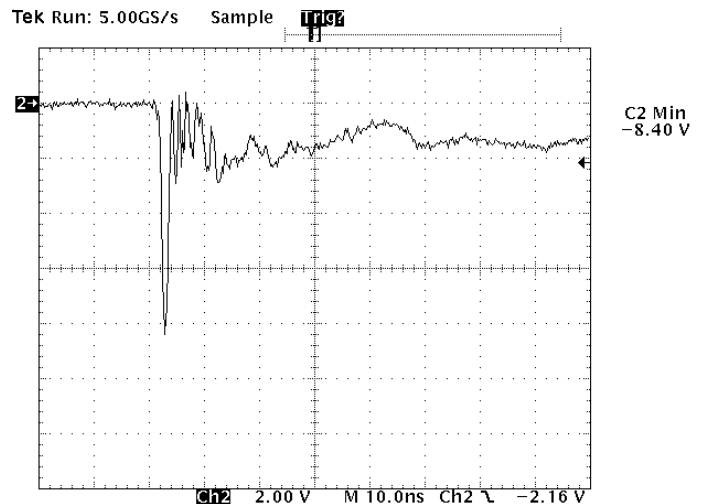

Note: Data is taken with a 10x attenuator

SO-8 Package Outline Drawing

2.8V TVS Array For ESD and Latch-Up Protection

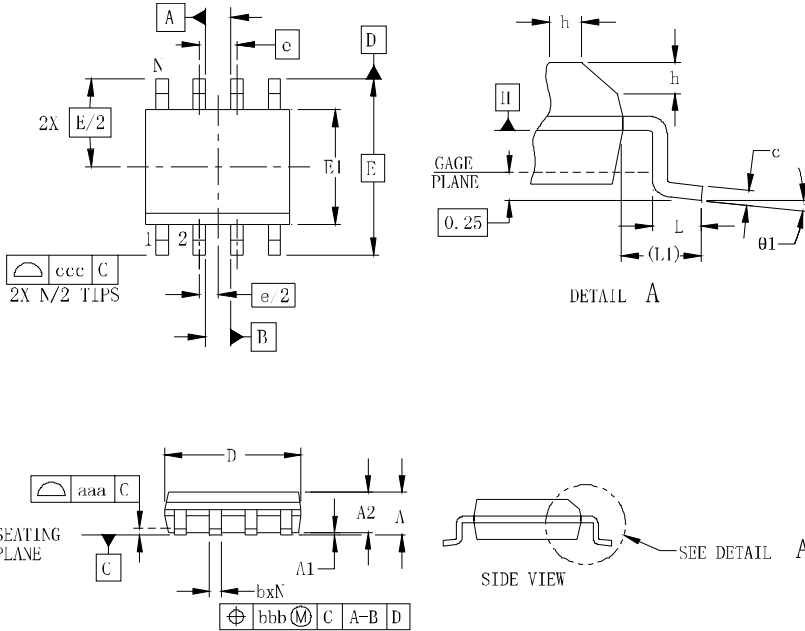

SY M	DIMENSIONS					
	MILLIMETERS			INCHES		
	MIN	NOM	MAX	MIN	NOM	MAX
A	1.35		1.75	0.053		0.069
A1	0.10		0.25	0.004		0.010
A2	1.25		1.65	0.049		0.065
b	0.31		0.51	0.012		0.020
c	0.17		0.25	0.007		0.010
D	4.80	4.90	5.00	0.189	0.193	0.197
E1	3.80	3.90	4.00	0.150	0.154	0.157
E	6.00 BSC			0.236 BSC		
e	1.27 BSC			0.050 BSC		
h	0.25		0.50	0.010		0.020
L	0.40	0.72	1.04	0.016	0.028	0.041
L1	(1.04)			(0.041)		
N	8			8		
theta1	0°		8°	0°		8°
aaa	0.10			0.004		
bbb	0.25			0.010		
ccc	0.20			0.008		

Suggested

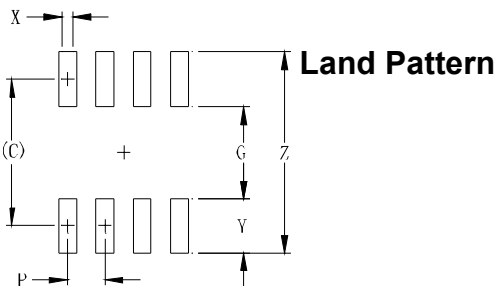

SYM	DIMENSIONS	
	MILLIMETERS	INCHES
C	(5.20)	0.205
G	3.00	0.118
P	1.27	0.050
X	0.60	0.024
Y	2.20	0.087
Z	7.40	0.291

Marking Information

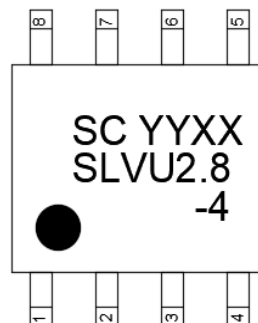

YYXX= Date Code
Dot denotes Pin1

Ordering Information

Part Number	Marking	Base qty	Delivery mode
UMW SLVU2.8-4.TBT	SLVU2.8-4	500	Tape & Reel