



**User Manual**

# **IDK-1119R-35SXA1E**

**TFT-LCD 19" SXGA (LED  
Backlight)**

**ADVANTECH**

*Enabling an Intelligent Planet*

---

## Copyright

The documentation and the software included with this product are copyrighted 2008 by Advantech Co., Ltd. All rights are reserved. Advantech Co., Ltd. reserves the right to make improvements in the products described in this manual at any time without notice. No part of this manual may be reproduced, copied, translated or transmitted in any form or by any means without the prior written permission of Advantech Co., Ltd. Information provided in this manual is intended to be accurate and reliable. However, Advantech Co., Ltd. assumes no responsibility for its use, nor for any infringements of the rights of third parties, which may result from its use.

## Acknowledgements

AMI is a trademark of American Megatrends Inc.

IBM and PC are trademarks of International Business Machines Corporation.

Intel® Core 2 Quad, Pentium Dual Core and Celeron are trademarks of Intel Corporation.

WinBond is a trademark of Winbond Corporation.

All other product names or trademarks are properties of their respective owners.

# A Message to the Customer

## Advantech Customer Services

Each and every Advantech product is built to the most exacting specifications to ensure reliable performance in the harsh and demanding conditions typical of industrial environments. Whether your new Advantech equipment is destined for the laboratory or the factory floor, you can be assured that your product will provide the reliability and ease of operation for which the name Advantech has come to be known.

Your satisfaction is our primary concern. Here is a guide to Advantech's customer services. To ensure you get the full benefit of our services, please follow the instructions below carefully.

## Technical Support

We want you to get the maximum performance from your products. So if you run into technical difficulties, we are here to help. For the most frequently asked questions, you can easily find answers in your product documentation. These answers are normally a lot more detailed than the ones we can give over the phone.

So please consult this manual first. If you still cannot find the answer, gather all the information or questions that apply to your problem, and with the product close at hand, call your dealer. Our dealers are well trained and ready to give you the support you need to get the most from your Advantech products. In fact, most problems reported are minor and are able to be easily solved over the phone.

In addition, free technical support is available from Advantech engineers every business day. We are always ready to give advice on application requirements or specific information on the installation and operation of any of our products.

---

## Product Warranty (2 years)

Advantech warrants to you, the original purchaser, that each of its products will be free from defects in materials and workmanship for two years from the date of purchase.

This warranty does not apply to any products which have been repaired or altered by persons other than repair personnel authorized by Advantech, or which have been subject to misuse, abuse, accident or improper installation. Advantech assumes no liability under the terms of this warranty as a consequence of such events.

Because of Advantech's high quality-control standards and rigorous testing, most of our customers never need to use our repair service. If an Advantech product is defective, it will be repaired or replaced at no charge during the warranty period. For out-of-warranty repairs, you will be billed according to the cost of replacement materials, service time and freight. Please consult your dealer for more details.

If you think you have a defective product, follow these steps:

1. Collect all the information about the problem encountered. (For example, CPU speed, Advantech products used, other hardware and software used, etc.) Note anything abnormal and list any onscreen messages you get when the problem occurs.
2. Call your dealer and describe the problem. Please have your manual, product, and any helpful information readily available.
3. If your product is diagnosed as defective, obtain an RMA (return merchandise authorization) number from your dealer. This allows us to process your return more quickly.
4. Carefully pack the defective product, a fully-completed Repair and Replacement Order Card and a photocopy proof of purchase date (such as your sales receipt) in a shippable container. A product returned without proof of the purchase date is not eligible for warranty service.
5. Write the RMA number visibly on the outside of the package and ship it prepaid to your dealer.

# Contents

<b>Chapter 1</b>	<b>Overview.....</b>	<b>1</b>
1.1	General Description .....	2
1.2	Display Characteristics.....	2
1.3	Functional Block Diagram .....	3
	Figure 1.1 Function block diagram .....	3
1.4	Absolute Maximum Ratings .....	3
1.4.1	Absolute Ratings of TFT LCD Module .....	3
1.4.2	Absolute Ratings of Backlight Unit.....	3
1.4.3	Absolute Ratings of Environment.....	3
1.5	Outline Dimension.....	4
1.5.1	Front View.....	4
1.5.2	Rear View .....	5
<b>Chapter 2</b>	<b>Electrical Characteristics.....</b>	<b>7</b>
2.1	Power Specification.....	8
	Table 2.1: Power specification.....	8
2.2	Backlight Unit .....	9
	Table 2.2: Backlight driving conditions .....	9
<b>Chapter 3</b>	<b>Signal Characteristics .....</b>	<b>11</b>
3.1	Pixel Format Image .....	12
3.2	The Input Data Format .....	12
3.3	Signal Description .....	13
	Table 3.1: Signal Description.....	13
3.4	Interface Timing .....	14
3.4.1	Timing Characteristics .....	14
	Table 3.2: Timing Characteristics .....	14
3.4.2	Input Timing Diagram.....	15
3.5	Power ON/OFF Sequence .....	15
<b>Chapter 4</b>	<b>Connector &amp; Pin Assignment.....</b>	<b>17</b>
4.1	TFT LCD Module.....	18
4.1.1	Connector .....	18
	Table 4.1: Connector .....	18
4.1.2	Pin Assignment.....	18
	Table 4.2: Pin Assignment.....	18
4.2	Backlight Unit .....	18
4.2.1	Signal for LED light bar connector .....	18
<b>Chapter 5</b>	<b>Touch Screen .....</b>	<b>21</b>
5.1	Touch Characteristics .....	22
5.2	Optical Characteristics .....	22
5.3	Environment Characteristics .....	22
5.4	Mechanical Characteristics .....	22
5.5	Electronic Characteristics.....	22
5.6	General Specifications .....	23

<b>Chapter 6</b>	<b>Touch Controller .....</b>	<b>25</b>
6.1	Touch Controller Characteristics.....	26
6.1.1	Specifications.....	26
6.1.2	Environmental Features.....	26
6.2	Pin Assignment and Description .....	27
6.2.1	Connector and LED Location.....	27
6.2.2	Combo Interface Connector, JP1, Pins and Signal Descriptions	27
	Figure 6.1 Board mounted header.....	28
6.2.3	Touch Screen Connector, JP2, Pins and Signal Descriptions....	28
6.3	Physical Dimension.....	28
<b>Appendix A</b>	<b>Optical Characteristics .....</b>	<b>29</b>
<b>Appendix B</b>	<b>Handling Precautions .....</b>	<b>33</b>
B.1	Handling Precautions.....	34

# Chapter 1

Overview

## 1.1 General Description

IDK-1119R-35SXA1E is a Color Active Matrix Liquid Crystal Display composed of a TFT-LCD panel, a driver circuit, and backlight system. The screen format is intended to support the SXGA (1280H x 1024V) screen and 16.7M colors (RGB 6-bits with HiFRC data). All input signals are LVDS interface compatible. Driver board of backlight is included.

## 1.2 Display Characteristics

The following items are characteristics summary on the table under 25°C condition:

Items	Unit	Specifications
Screen Diagonal	[mm]	482.6 (19.0")
Active Area	[mm]	376.32 (H) x 301.06 (V)
Pixels H x V		1280(x3) x 1024
Pixel Pitch	[mm]	0.294 (per one triad) x 0.294
Pixel Arrangement		R.G.B. Vertical Stripe
Display Mode		Normally White
White Luminance	[cd/m <sup>2</sup> ]	350
Contrast Ratio		1000 : 1 (Typ)
Optical Response Time	[msec]	5 ms (Typ, on/off)
Nominal Input Voltage VDD	[Volt]	+5.0 V
Power Consumption	[Watt]	20.55 W (PDD= 5.5W @LED=80mA)
Weight	[Grams]	2750 (Typ)
Physical Size (H x V x D)	[mm]	396 (H) x 324 (V) x 20.7 (D) (Typ)
Electrical Interface		Dual channel LVDS
Surface Treatment		Anti-Glare treatment
Support Color		16.7M colors (RGB 6-bit data + HiFRC data)
Temperature Range		
Operating	[°C]	0 to +50
Storage (Non-Operating)	[°C]	-20 to +60
RoHS Compliance		RoHS Compliance



## 1.3 Functional Block Diagram

The following diagram shows the functional block of the 19 inches Color TFT-LCD Module:

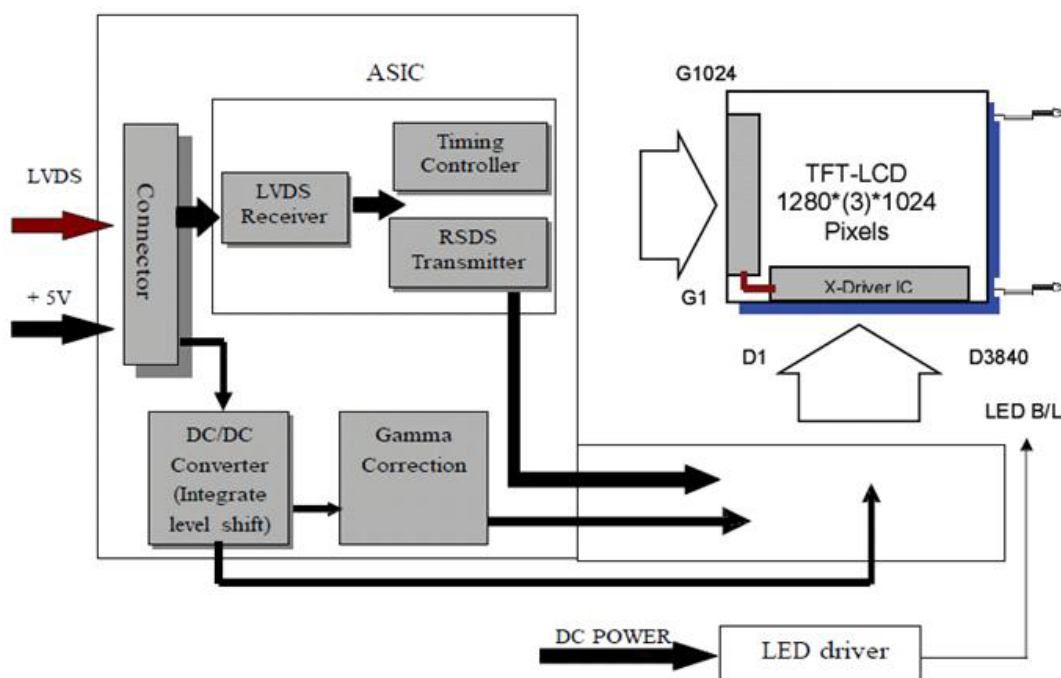

Figure 1.1 Function block diagram

## 1.4 Absolute Maximum Ratings

Absolute maximum ratings of the module is as following:

### 1.4.1 Absolute Ratings of TFT LCD Module

Item	Symbol	Min.	Max.	Unit	Conditions
Logic/LCD Drive Voltage	Vin	0.3	+5.5	[Volt]	Note 1, 2

### 1.4.2 Absolute Ratings of Backlight Unit

Item	Symbol	Min.	Max.	Unit	Conditions
LED Light Bar Current	ILed	-	1.25	[A]rms	Note 1, 2

### 1.4.3 Absolute Ratings of Environment

Item	Symbol	Min.	Max.	Unit	Conditions
Operating Temperature	TOP	0	+50	[oC]	Note 3
Operation Humidity	HOP	5	90	[%RH]	
Storage Temperature	TST	-20	+60	[oC]	
Storage Humidity	HST	5	90	[%RH]	

**Note1:** With in Ta= 25°C and no condensation

**Note2:** Permanent damage to the device may occur if exceed maximum values

**Note3:** For quality performance, please refer to AUO IIS (Incoming Inspection Standard).

# 1.5 Outline Dimension

## 1.5.1 Front View

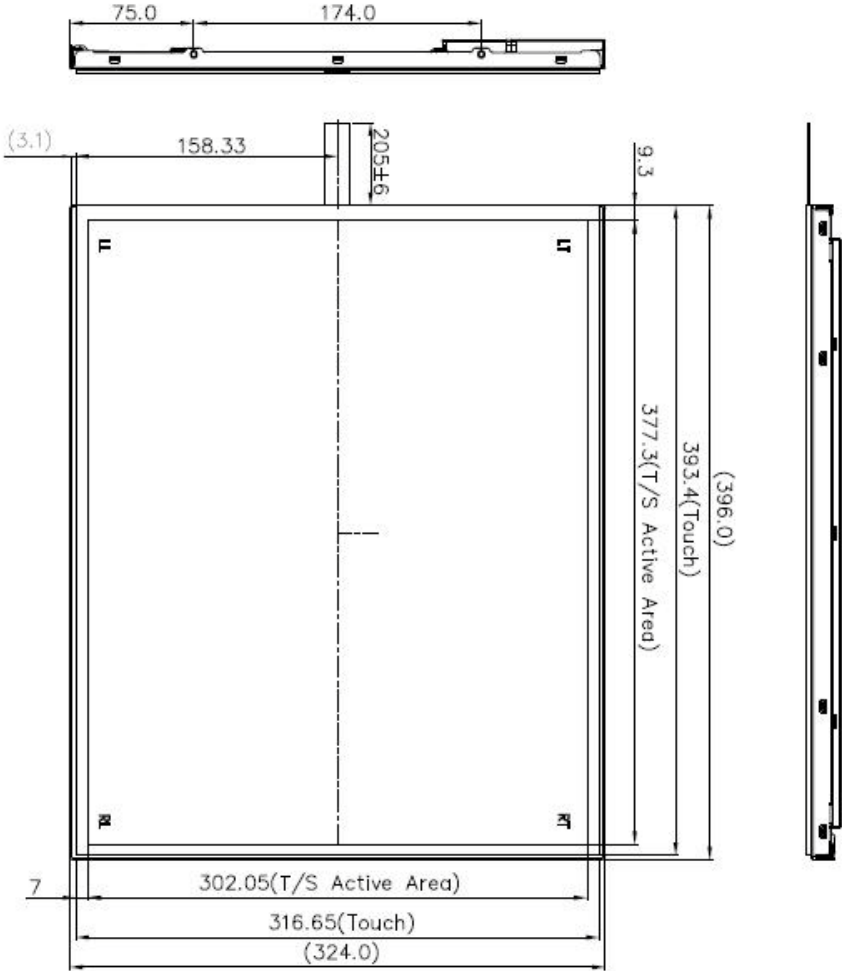

### 1.5.2 Rear View

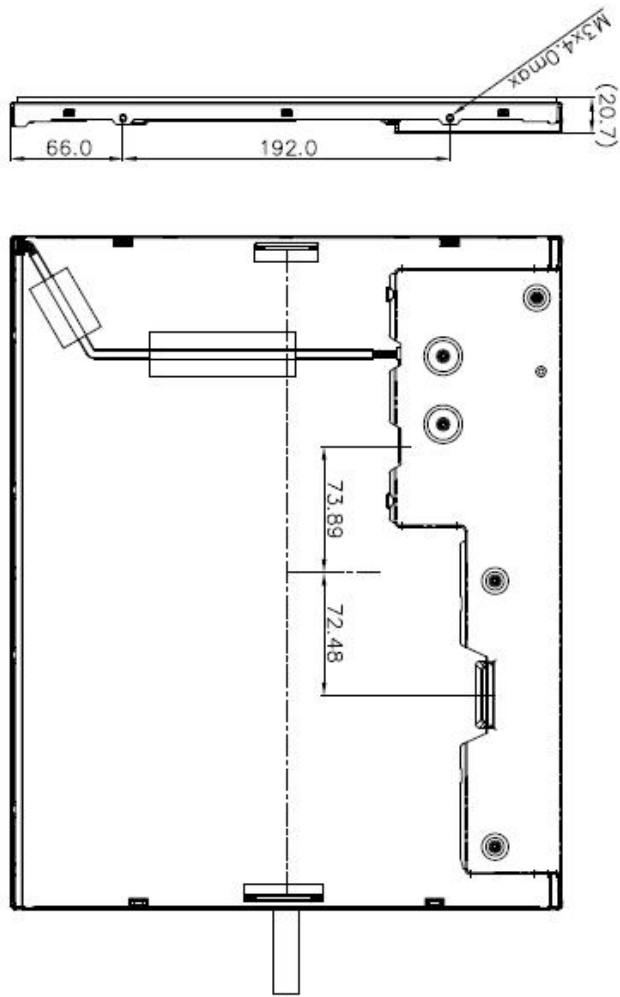



# Chapter 2

Electrical  
Characteristics

## 2.1 Power Specification

Input power specifications are as follows:

**Table 2.1: Power specification**

Symbol	Parameter	Min.	Typ.	Max.	Unit	Condition
VCC	Logic/LCD Drive Voltage	4.5	5	5.5	[Volt]	±10%
ICC	Input Current	-	0.94	1.1	[A]	Vin=5V, at 60Hz All black pattern
IRush	Inrush Current	-	2.1	2.5	[A]	Note 2
PCC	VCCPower	-	4.7	5.5	[Watt]	Vin=5V, at 60Hz) All black pattern
VCCrp	Allowable Logic/ LCD Drive Ripple Voltage	-	-	300	[mV] p-p	With panel loading

**Note 1** Measurement condition:

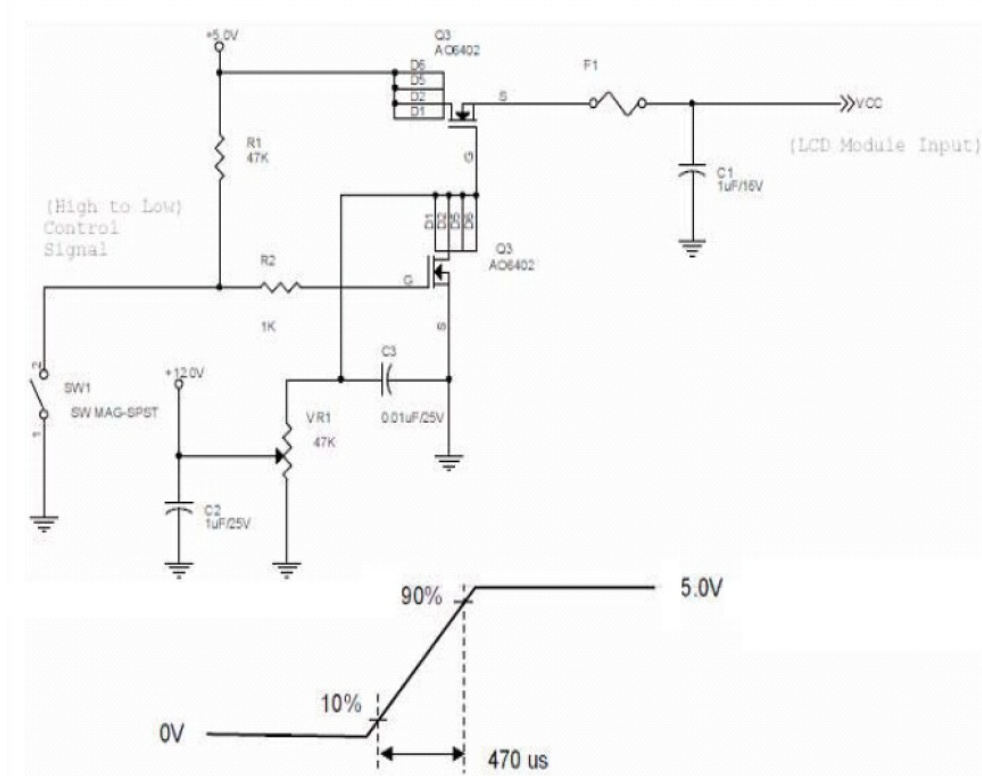

## 2.2 Backlight Unit

Following characteristics are measured under a stable condition at 25°C (Room Temperature):

Table 2.2: Backlight driving conditions						
Symbol	Parameter	Values			Unit	Condition
		Min.	Typ.	Max.		
VCC	Input Voltage		12		[Volt]	
I <sub>VCC</sub>	Input Current		1.15	1.25	[A]	100% PWM Duty
P <sub>VCC</sub>	Power Consumption		13.8	15	[Watt]	100% PWM Duty
I <sub>rush LED</sub>	Inrush Current		2.1	2.5	[A]	at rising time=470us
F <sub>PWM</sub>	Dimming Frequency		0.2	20	[kHz]	
	Swing Voltage	-	3.3	-	V [A]	
	Dimming Duty Cycle	10	-	100	%	
I <sub>F</sub>	LED Forward Current		80		mA	Ta = 25°C
V <sub>F</sub>	LED Forward Voltage	-	-	-	Volt	
		-	3.5	4	Volt	I <sub>F</sub> =80mA, Ta = 25°C
		-	-	-		
P <sub>LED</sub>	LED Power	-	12	14.4	Watt	I <sub>F</sub> =80 mA, Ta = 25°C
	Consumption					
Operation Lifetime		50,000			Hrs	I <sub>F</sub> =80mA, Ta= 25°C

**Note 1** Ta means ambient temperature of TFT-LCD module.

**Note 2** VCC, I<sub>vcc</sub>, P<sub>VCC</sub>, I<sub>rush LED</sub> are defined for LED B/L.(100% duty of PWM dimming).

**Note 3** I<sub>F</sub>, V<sub>F</sub>, P<sub>LED</sub> are defined for LED Light Bar.

**Note 4** If IDK-1119R-35SXA1E module is driven by high current or at high ambient temperature & humidity condition. The operating life will be reduced.

**Note 5** Operating life means brightness goes down to 50% initial brightness. Minimum operating lifetime is estimated data.





# Chapter 3

## Signal Characteristics

### 3.1 Pixel Format Image

Following figure shows the relationship between input signal and LCD pixel format.

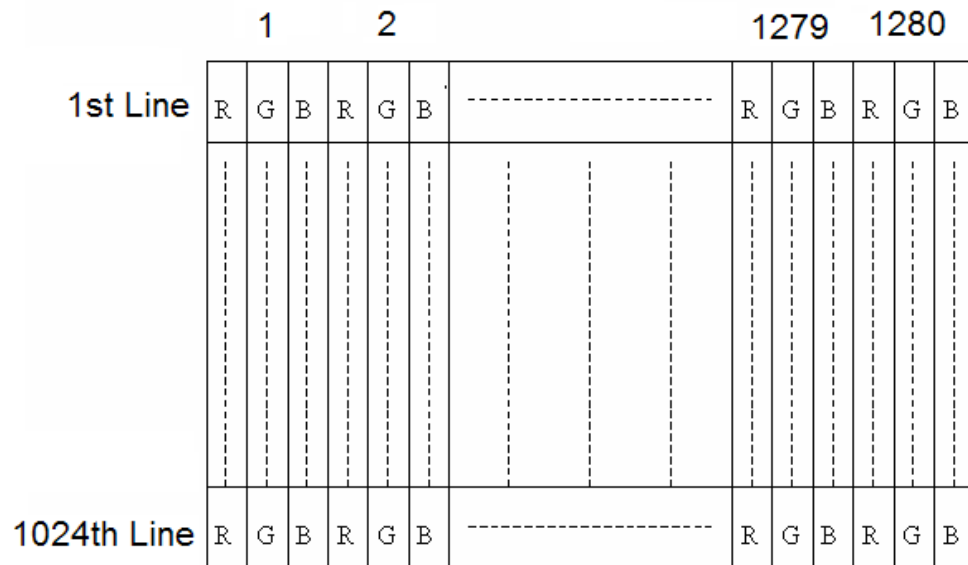

### 3.2 The Input Data Format

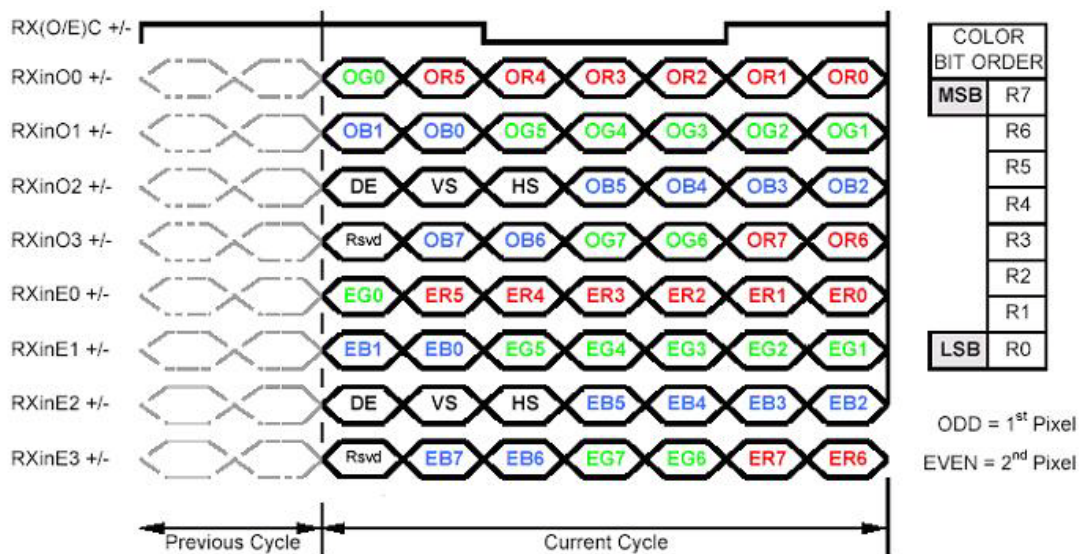

**Note 1** Normally DE mode only. VS and HS on EVEN channel are not used.

**Note 2** Please follow VESA.

**Note 3** 8-bit in

### 3.3 Signal Description

The module using a pair of LVDS receiver SN75LVDS82 (Texas Instruments) or compatible. LVDS is a differential signal technology for LCD interface and high speed data transfer device. Transmitter shall be SN75LVDS83 (negative edge sampling) or compatible. The first LVDS port (RxOxxx) transmits odd pixels while the second LVDS port (RxExxx) transmits even pixels.

**Table 3.1: Signal Description**

Pin No.	Sigal Name	Description
1	RxOIN0-	Negative LVDS differential data input (Odd data)
2	RxOIN0+	Positive LVDS differential data input (Odd data)
3	RxOIN1-	Negative LVDS differential data input (Odd data)
4	RxOIN1+	Positive LVDS differential data input (Odd data)
5	RxOIN2-	Negative LVDS differential data input (Odd data, H-Sync,V-Sync,DSPTMG)
6	RxOIN2+	Positive LVDS differential data input (Odd data, H-Sync,V-Sync,DSPTMG)
7	VSS	Power Ground
8	RxOCLKIN-	Negative LVDS differential clock input (Odd clock)
9	RxOCLKIN+	Positive LVDS differential clock input (Odd clock)
10	RxOIN3-	Negative LVDS differential data input (Odd data)
11	RxOIN3+	Positive LVDS differential data input (Odd data)
12	RxEIN0-	Negative LVDS differential data input (Even data)
13	RxEIN0+	Positive LVDS differential data input (Even data)
14	VSS	Power Ground
15	RxEIN1-	Negative LVDS differential data input (Even data)
16	RxEIN1+	Positive LVDS differential data input (Even data)
17	VSS	Power Ground
18	RxEIN2-	Negative LVDS differential data input (Even data)
19	RxEIN2+	Positive LVDS differential data input (Even data)
20	RxECLKIN-	Negative LVDS differential clock input (Even clock)
21	RxECLKIN+	Positive LVDS differential clock input (Even clock)
22	RxEIN3-	Negative LVDS differential data input (Even data)
23	RxEIN3+	Positive LVDS differential data input (Even data)
24	VSS	Power Ground
25	VSS	Power Ground
26	NC	Do not connect ( for AUO test)
27	VSS	Power Ground
28	VCC	+5.0V Power Supply
29	VCC	+5.0V Power Supply
30	VCC	+5.0V Power Supply

**Note1** Input signals of odd and even clock shall be the same timing. And start from the left side.

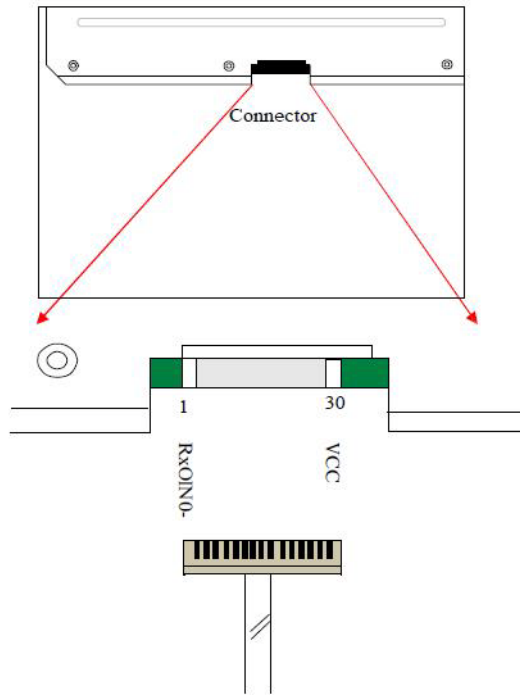

**Note2** Input signals of add and even clock shall be the same timing

**Note3** Please follow VESA.

## 3.4 Interface Timing

### 3.4.1 Timing Characteristics

Table 3.2: Timing Characteristics						
Signal	Parameter	Symbol	Min.	Typ.	Max.	Unit
Vertical Section	Period	$T_v$	1032	1066	1150	Th
	Active	$T_{disp(v)}$	1024	1024	1024	Th
	Blanking	$T_{bp(v)}+T_{fp(v)}+PWvs$	8	42	126	Th
Horizontal Section	Period	$T_h$	780	844	2047	Tclk
	Active	$T_{disp(h)}$	640	640	640	Tclk
	Blanking	$T_{bp(h)}+T_{fp(h)}+PWhs$	140	204	-	Tclk
Clock	Period	Tclk	22.2	18.52	14.81	ns
	Frequency	Freq.	45	54	67.5	MHz
Frame Rate	Frequency	$1/T_v$	50	60	75	Hz

**Note** DE mode only.

### 3.4.2 Input Timing Diagram

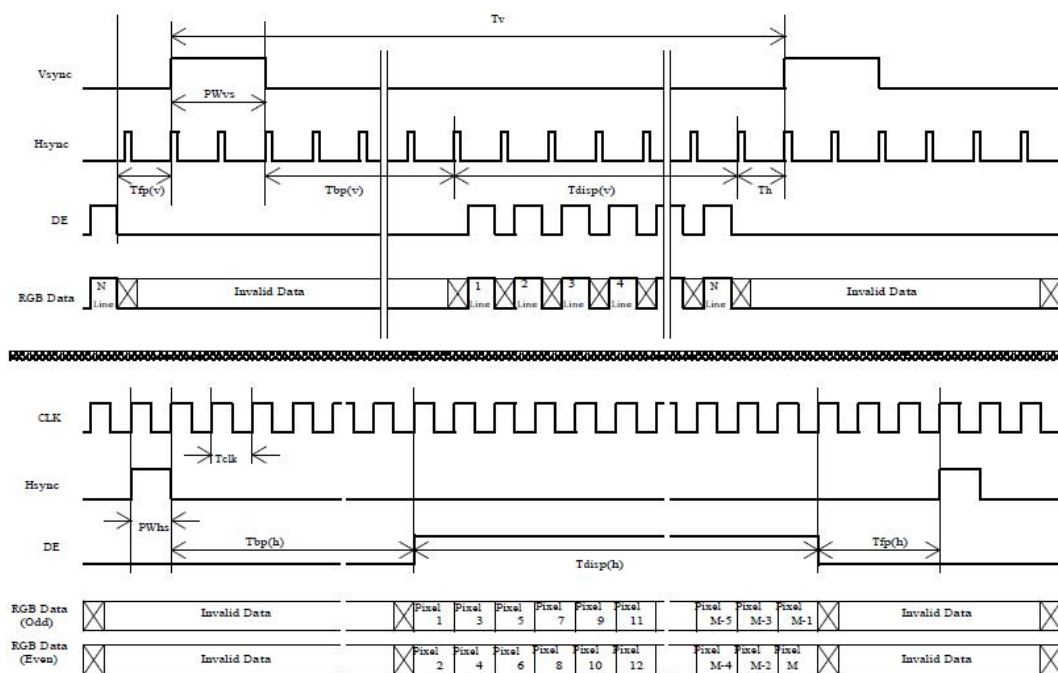

### 3.5 Power ON/OFF Sequence

VDD power and LED on/off sequence is as follows. Interface signals are also shown in the chart. Signals from any system shall be Hi-Z state or low level when VDD is off.

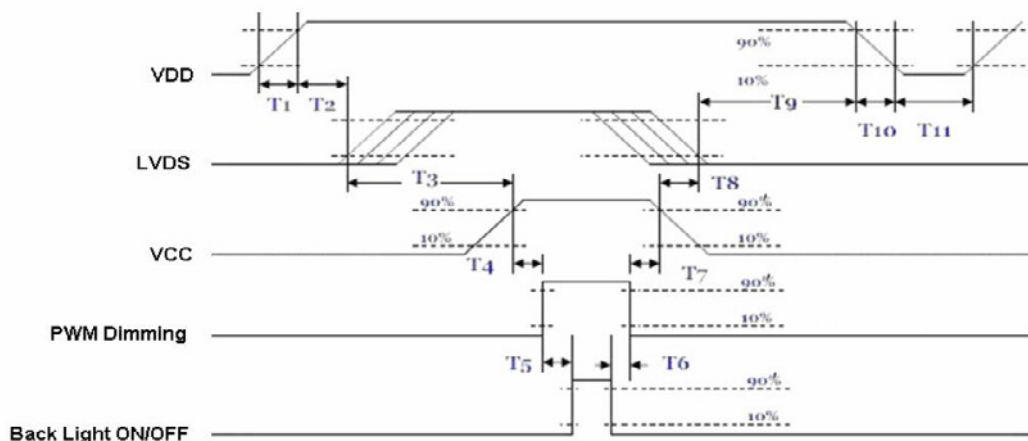

#### Power Sequence Timing

Parameter	Value			Unit
	Min.	Typ.	Max.	
T1	0.5	-	10	[ms]
T2	30	40	50	[ms]
T3	175	-	-	[ms]
T4	10	-	-	[ms]
T5	10	-	-	[ms]

---

T6	0	-	-	[ms]
T7	10	-	-	[ms]
T8	100			
T9	0	16	50	
T10				
T11	1000			

# Chapter 4

Connector & Pin  
Assignment

## 4.1 TFT LCD Module

Physical connector pins are assigned the following signals.

### 4.1.1 Connector

**Table 4.1: Connector**

Connector Name / Designation	Interface Connector / Interface card
Manufacture	JAE / P-TWO
Type Part Number	FI-XB30SSLA-HF15 / 187034-30091
Mating Housing Part Number	FI-X30HL FI-X30H (Unlocked Type)

### 4.1.2 Pin Assignment

**Table 4.2: Pin Assignment**

Pin No.	Signal Name	Pin No.	Signal Name
1	RxOIN0-	2	RxOIN0+
3	RxOIN1-	4	RxOIN1+
5	RxOIN2-	6	RxOIN2+
7	VSS	8	RxOCLKIN-
9	RxOCLKIN+	10	RxOIN3-
11	RxOIN3+	12	RxEIN0-
13	RxEIN0+	14	VSS
15	RxEIN1-	16	RxEIN1+
17	VSS	18	RxEIN2-
19	RxEIN2+	20	RxECLKIN-
21	RxECLKIN+	22	RxEIN3-
23	RxEIN3+	24	VSS
25	VSS	26	NC
27	VSS	28	VCC
29	VCC	30	VCC

## 4.2 Backlight Unit

Physical connector pins are assigned the following signals.

Connector Name / Designation	LED Light Bar Connector / Backlight
Manufacturer	STM
Type Part Number	MS24019R
Mating Type Part Number	P24019

### 4.2.1 Signal for LED light bar connector

Pin No.	Signal Name	Pin Description
1	+12V	Power +12V



2	+12V	Power +12V
3	+12V	Power +12V
4	NC	NC
5	GND	GND
6	GND	GND
7	GND	GND
8	EN	Enable(max.5V)
9	Dimming	PWM (duty 10%~ 100%)



# Chapter 5

Touch Screen

## 5.1 Touch Characteristics

This touch panel uses a 5-wire Analog resistance type that customers use with flat displays like LCDs. Once a user touches it with a stylus or finger, the circuit sends coordinate points from voltages to the CPU at the contact point.

## 5.2 Optical Characteristics

	Item	Specification	Remarks
1	TRANSPARENCY	80% ± 3%	BYK-Gardner
2	HAZE	8.0% ± 3%	BYK-Gardner

## 5.3 Environment Characteristics

	Item	Specification	Remarks
	Operation temperature	-20°C ~ 70°C	Note: All terms under 1 atmosphere
	Storage temperature	-40°C ~ 80°C	
	Operation Humidity	20% ~ 80%RH	
	Storage temperature	20% ~ 90%RH	

## 5.4 Mechanical Characteristics

	Item	Specification	Remarks
1	Hardness of surface	Pencil hardness 3H.	JIS K-5600-5-4 150gf, 45 degree
2	FPC peeling strength	1) 5N (5N Min.) 2) 19.6N (19.6N Min.)	1) Peeling upward by 90° 2) Peeling downward by 90°
3	Operation force	Pen 0.05N~1.96N Finger (5~200gf)	Dot-Spacer Within "guaranteed active area", but not on the age and Dot-Spacer.

## 5.5 Electronic Characteristics

	Item	Specification	Remarks
1	Rated Voltage	DC 7V max.	
2	Loop Resistance	X axis: 200 ~ 500Ω(Figure as bellow) Y axis: 200 ~ 800Ω(Figure as bellow)	FPC connector
3	Linearity	X ≤1.5% (Figure as bellow) Y ≤1.5% (Figure as bellow)	Reference: 250gf
4	Chattering	15ms	
5	Insulation Resistance	≥20MΩ min (DC 25V)	

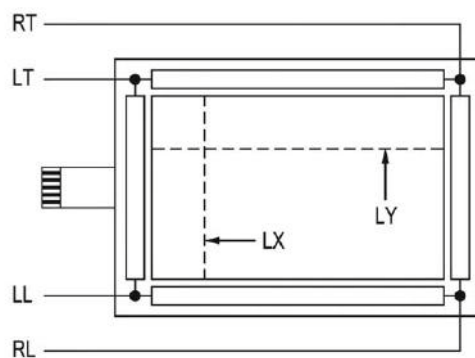

## 5.6 General Specifications

	Item	Specification
1	Frame size	393.40±0.50 X 316.65±0.50 mm
2	View Area	380.90±0.20 X 305.65±0.20 mm
3	Active Area	377.30±0.20 X 302.05±0.20 mm
4	Total Thickness	3.20±0.20 mm
5	Tail length	305.00±6.00 mm



# Chapter 6

Touch Controller

Advantech ETM-RES04C Touch Control Board is the ultimate combo board. This touch panel controller provides optimum performance for your analog resistive touch panels for 5 wire models. It communicates with the PC directly through USB and RS-232 connectors. The touch panel driver emulates mouse left and right button functions.

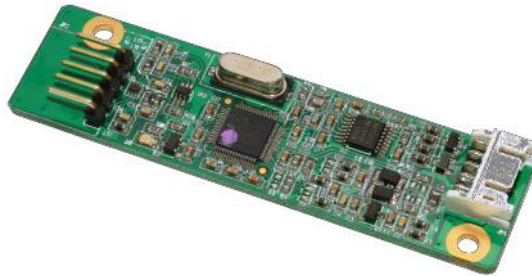

## 6.1 Touch Controller Characteristics

### 6.1.1 Specifications

#### ■ Electrical Features

- +5 Vdc/ 100 mA typical, 50mV peak to peak maximum ripple and noise.
- Bi-directional RS-232 serial communication and USB 1.1 full speed
- Report rate of RS-232 is 180 points/sec (max.). And, USB is 200 points/sec (max.)
- Unaffected by environmental EMI
- Panel resistance of 5-wire resistive model is from 50 to 200 ohm (Pin to pin on same layer)
- Touch resistance under 3K ohm

#### ■ Serial Interface

- EIA 232E (Serial RS-232)
- No parity, 8 data bits, 1 stop bit, 9600 baud (N, 8, 1, 9600)
- Support Windows 2000/ Vista/ XP/ 7, Windows CE 5.0/ 6.0/ 7.0, Windows NT4, Linux, DOS, QNX

#### ■ USB Interface

- Conforms to USB Revision 1.1 full speed.
- If the USB is connected to the controller, the controller will communicate over the USB, and will not communicate over the serial port.
- Supports Windows 2000/ Vista/ XP/ 7, Windows CE 5.0/ 6.0/ 7.0, Linux, QNX

#### ■ Touch Resolution

- 2,048 x 2,048 resolution

#### ■ Response Time

- Max. 20 ms

### 6.1.2 Environmental Features

#### ■ Reliability

- MTBF is 200,000 hours

#### ■ Temperature Ranges

- Operating : -25°C ~ 85°C
- Storage : -25°C ~ 85°C

#### ■ Relative Humidity



- 95% at 60°C, RH Non-condensing

**Acquired RoHS certificate**  
**Regulatory FCC-B, CE approvals**  
**Dimension: 75 mm x 20 mm x 10 mm**

## 6.2 Pin Assignment and Description

### 6.2.1 Connector and LED Location

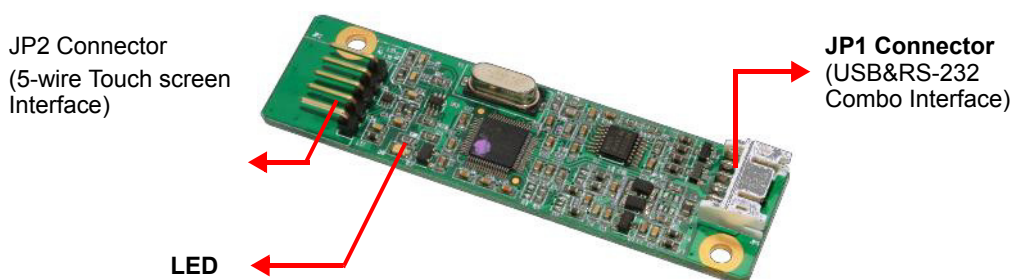

### 6.2.2 Combo Interface Connector, JP1, Pins and Signal Descriptions

The combo interface connector, USB and RS-232, is a box 2.0mm 10-pins 90 degree, Male type with lock connector, intended to be used with single wired pins in 5+5 pins header. The pins are numbered as shown in the table below.

USB Pin#	Signal Name	Signal Function	RS-232 Pin#	Signal Name	Signal Function
1	G	Ground	1	G	Ground
2	V	USB Power	2	V	Power
3	G	Ground	3	G	Ground
4	D+	USB D+	4	TxD	Serial Port
5	D-	USB D-	5	RxD	Serial Port

Signal Name	DB-9 pin #	RS-232 pin #	Sourced by	Signal Description
RxD	2	5	ctrl	serial data from controller to host
TxD	3	4	host	serial data from host to controller

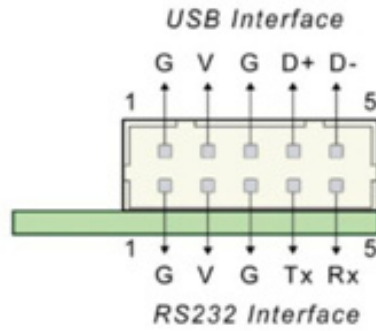
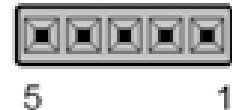
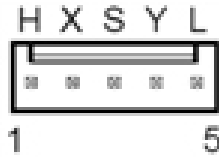
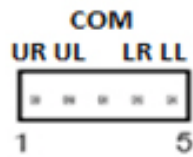

Figure 6.1 Board mounted header

### 6.2.3 Touch Screen Connector, JP2, Pins and Signal Descriptions

The Touch Screen connector, JP2, is a single row by 2.54mm 5-pins 90 degree, Male type connector. The pins are numbered as shown in the table below.

JP2 Pin #	Signal Name	Signal Description
1	H / UR	Drive signal attached to the touchscreen substrate upper right corner when viewed from a user's perspective.
2	Y / UL	Drive signal attached to the substrate upper left corner.
3	COM	-
4	X / LR	Drive signal attached to the substrate lower right corner.
5	L / LL	Drive signal attached to the substrate lower left corner.



### 6.3 Physical Dimension

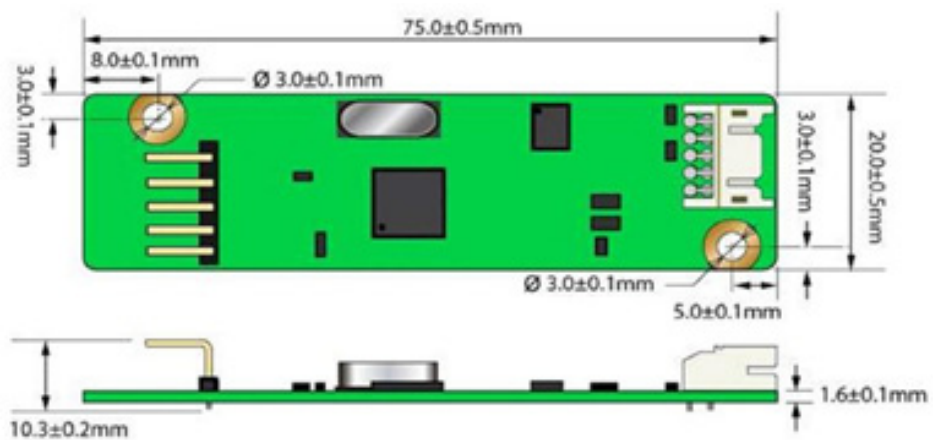

# Appendix **A**

Optical Characteristics

The optical characteristics are measured under stable conditions at 25°C (Room Temperature):

Item	Unit	Conditions	Min.	Typ.	Max.	Note
Viewing Angle	[degree]	Horizontal (Right)	75	85	-	1
		CR = 10 (Left)	75	85	-	
		Vertical (Up)	70	80	-	
		CR = 10 (Down)	70	80	-	
		Horizontal (Right)	75	85	-	
		CR = 5 (Left)	75	85	-	
Vertical (Up)	70	80	-			
CR = 5 (Down)	70	80	-			
Luminance Uniformity	[%]	9 Points	75	80	-	2, 3
Optical Response Time	[msec]	Rising	-	3.6	5.7	4, 6
		Falling	-	1.4	2.3	4, 6
		Rising + Falling	-	5	8	4, 6
Color / Chromaticity Coordinates (CIE)		Red x	0.594	0.644	0.694	
		Red y	0.292	0.342	0.392	
		Green x	0.273	0.323	0.373	
		Green y	0.571	0.621	0.671	4
		Blue x	0.098	0.148	0.198	
		Blue y	0.011	0.061	0.111	
		White x	0.263	0.313	0.363	
		White y	0.279	0.329	0.379	
White Luminance (At LED= 80mA)	[cd/m <sup>2</sup> ]		350	-	4	
Contrast Ratio			600	1000	-	4
Cross Talk (At 60Hz)	[%]		-	-	1.5	5
Flicker	[dB]		-	-	-20	7

Optical Equipment: BM-7, DT-101, or equivalent

**Note 1** Definition of viewing angle

Viewing angle is the measurement of contrast ratio  $\geq 10$ , at the screen center, over a 180° horizontal and 180° vertical range (off-normal viewing angles). The 180° viewing angle range is broken down as below: 90° ( $\theta$ ) horizontal left and right, and 90° ( $\Phi$ ) vertical high (up) and low (down). The measurement direction is typically perpendicular to the display surface with the screen rotated to its center to develop the desired measurement viewing angle.

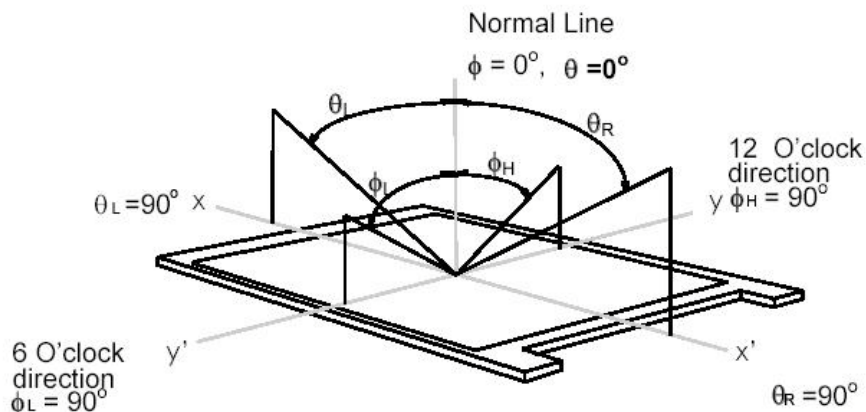

**Note 2** 9 points position

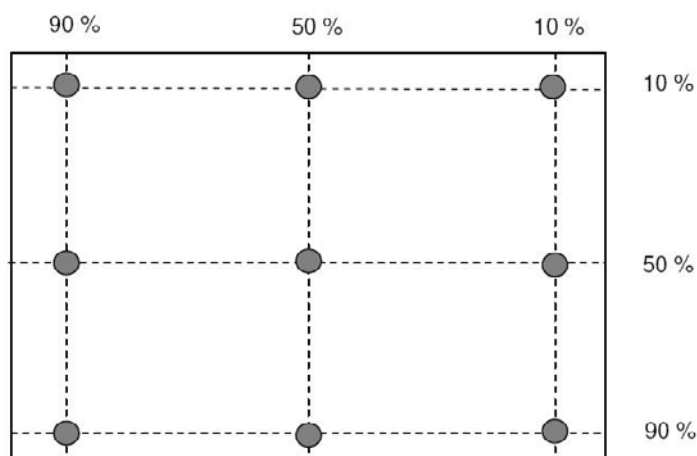

**Note 3** The luminance uniformity of 9 points is defined by dividing the maximum luminance values by the minimum test point luminance

$$\delta w_9 = \frac{\text{Minimum Luminance of 9 points}}{\text{Maximum Luminance of 9 points}}$$

**Note 4** Measurement method

The LCD module should be stabilized at given temperature for 20 minutes to avoid abrupt temperature change during measuring. In order to stabilize the luminance, the measurement should be executed after lighting Backlight for 20 minutes in a windless room.

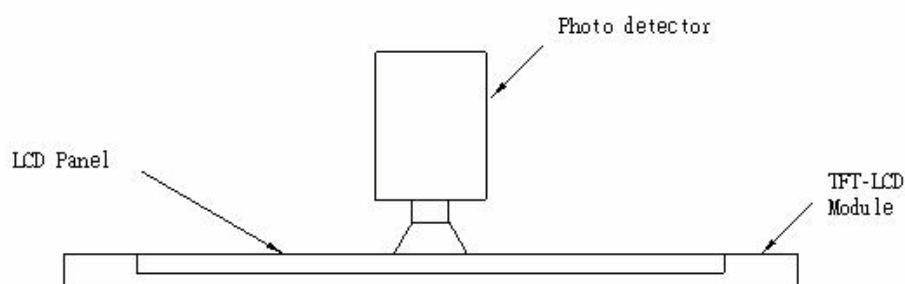

**Note 5** Definition of response time, measured by WESTAR TRD-100A

The output signals of photo detector are measured when the input signals are changed from “Full Black” to “Full White” (rising time), and from “Full White” to “Full Black” (falling time), respectively. The response time is interval between the 10% and 90% of amplitudes. Please refer to the figure as below.

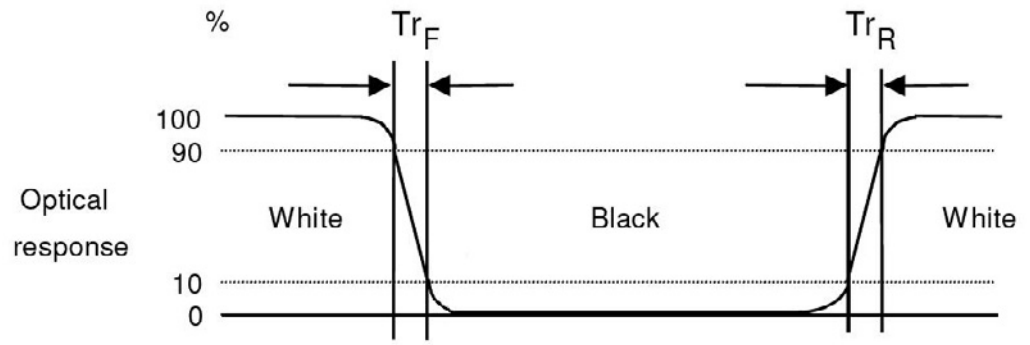

# Appendix **B**

## Handling Precautions

---

## B.1 Handling Precautions

The optical characteristics are measured under stable conditions at 25°C (Room Temperature)

1. Since front polarizer is easily damaged, pay attention not to scratch it.
2. Be sure to turn off power supply when inserting or disconnecting from input connector.
3. Wipe off water drop immediately. Long contact with water may cause discoloration or spots.
4. When the panel surface is soiled, wipe it with absorbent cotton or other soft cloth.
5. Since the panel is made of glass, it may break or crack if dropped or bumped on hard surface.
6. Since CMOS LSI is used in this module, take care of static electricity and insure people are earthed when handling.
7. Do not open or modify the Module Assembly.
8. Do not press the reflector sheet at the back of the module to any directions.
9. In case if a Module has to be put back into the packing container slot after once it was taken out from the container, please press at the far end of the LED light bar reflector edge softly. Otherwise the TFT Module may be damaged.
10. At the insertion or removal of the Signal Interface Connector, be sure not to rotate nor tilt the Interface Connector of the TFT Module.
11. After installation of the TFT Module into an enclosure, do not twist nor bend the TFT Module even momentary. At designing the enclosure, it should be taken into consideration that no bending/twisting forces are applied to the TFT Module from outside. Otherwise the TFT Module may be damaged.
12. Small amount of materials having no flammability grade is used in the LCD module. The LCD module should be supplied by power complied with requirements of Limited Power Source (IEC60950 or UL1950), or be applied exemption.



**ADVANTECH**

*Enabling an Intelligent Planet*

**[www.advantech.com](http://www.advantech.com)**

Please verify specifications before quoting. This guide is intended for reference purposes only.

All product specifications are subject to change without notice.

No part of this publication may be reproduced in any form or by any means, electronic, photocopying, recording or otherwise, without prior written permission of the publisher.

All brand and product names are trademarks or registered trademarks of their respective companies.

© Advantech Co., Ltd. 2012