

APPROVED: \_\_\_\_\_  
 DATE: \_\_\_\_\_ TITLE: \_\_\_\_\_

Rev	AWO #	Description	Date	Appr
-		RELEASED	11/2/21	
A		UPDATED SPEC.	11/8/21	JJ/RC

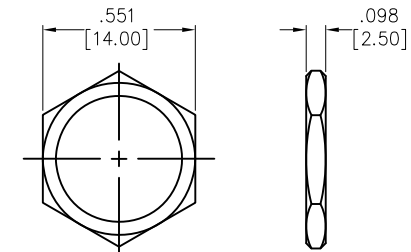

NUT

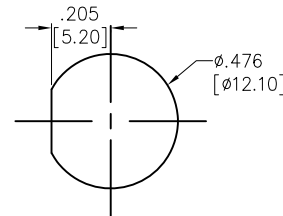
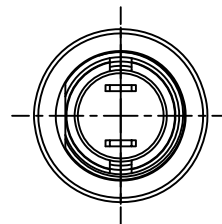
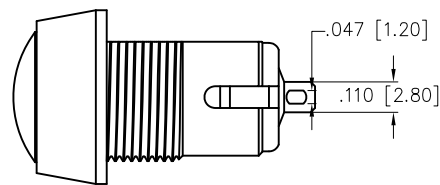
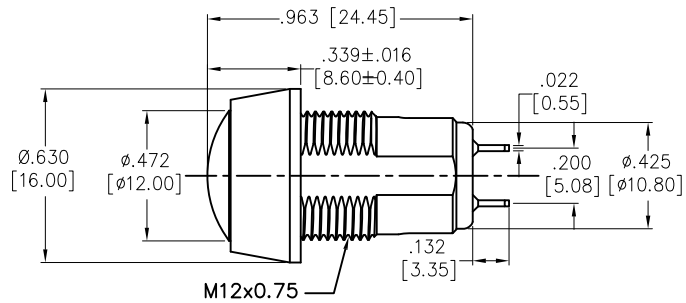
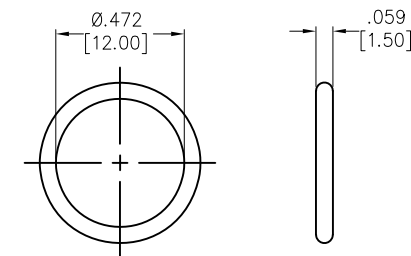

O-RING

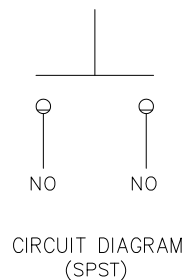

CIRCUIT DIAGRAM (SPST)

**SPECIFICATIONS:**

**Material:**

Bushing: Stainless Steel, Varnish polished

Contact Material: Copper Alloy,

Plating: Gold over Silver

**Electrical:**

Switch Rating: 100mA @ 24V DC  
 2A @ 125V AC

Contact resistance: 50 mΩ max initial.

Insulation resistance: 1G ohms min @ 500 VDC

Dielectric withstanding voltage: 1000 VAC for 1 minute

Electrical Life: 1,000,000 cycles min.

**Temperature Rating:**

Operating temperature: -30°C to +85°C

**Environmental:**

Water proof: IP67

Lead free, RoHS compliant



UNLESS OTHERWISE SPECIFIED ALL DIMENSIONS ARE INCHES [MM]. TOLERANCES: EXCEPT AS NOTED

INCHES		HOLES	
.X	±.10	ØX	±.10
.XX	±.020	ØXX	±.015
.XXX	±.015	ØXXX	±.010

DRAWN	JJ	11/2/21
CHECKED	RC	11/2/21
APPROVED		

THIS DRAWING CONTAINS INFORMATION THAT IS PROPRIETARY AND SHOULD NOT BE USED WITHOUT PRIOR WRITTEN PERMISSION FROM ADAM TECH



909 Rahway Avenue,  
 Union, NJ 07083  
 Phone: 908-687-5000  
 Fax: 908-687-5710

TITLE  
**SWITCH, ANTI-VANDAL SEALED, PUSH BUTTON,  
 SOLDER SPST, 12mm, LATCHING**

SIZE	PART NO.	REV.
X	SW-PB7-04B42AR	A
REF: S00198T	SCALE: NTS	SHEET 1 OF 1