

## Vienna Rectifier SiC MOSFET Power Module

### Product Overview

The MSCSM70VR1M19C1AG device is a Vienna rectifier 700V, 124A silicon carbide (SiC) power module.

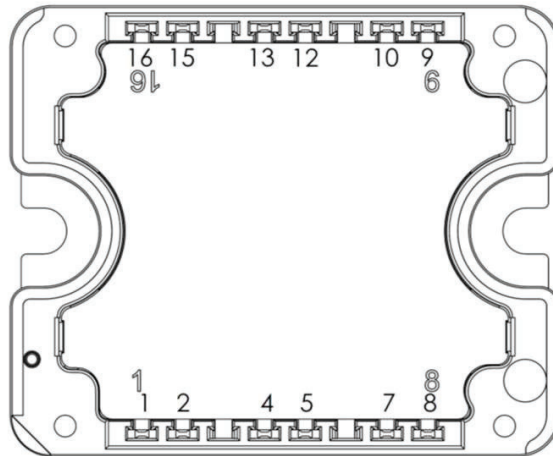
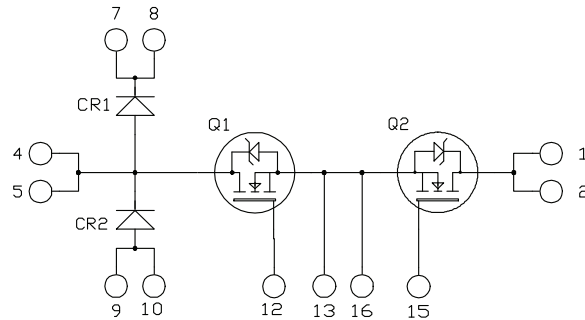

**Notes:**

- Pins 1/2; 4/5; 7/8; 9/10 must be shorted together.
- All ratings at  $T_j = 25\text{ }^\circ\text{C}$ , unless otherwise specified.



These devices are sensitive to electrostatic discharge. Proper handling procedures must be followed.

## Features

The following are the key features of MSCSM70VR1M19C1AG device:

- SiC Power MOSFET
  - Low  $R_{DS(on)}$
  - High speed switching
  - Ultra low loss
- SiC Schottky Diode
  - Zero reverse recovery
  - Zero forward recovery
  - Temperature independent switching behavior
  - Positive temperature coefficient on  $V_F$
- Low stray inductance
- Kelvin source for easy drive
- Aluminum Nitride (AlN) substrate for improved thermal performance

## Benefits

The following are the benefits of MSCSM70VR1M19C1AG device:

- Outstanding performance at high frequency operation
- High-power and high-efficiency rectifiers and converters
- Direct mounting to heatsink (isolated package)
- Low junction-to-case thermal resistance
- Solderable terminals both for power and signal for easy PCB mounting
- Low profile
- RoHS compliant

## Applications

The following are the applications of MSCSM70VR1M19C1AG device:

- Power factor correction
- Switched mode power supplies
- Uninterruptible power supplies

## 1. Electrical Specifications

The following sections show the electrical specifications of the MSCSM70VR1M19C1AG device.

### 1.1 SiC MOSFET Characteristics (Per SiC MOSFET)

The following table lists the absolute maximum ratings (per SiC MOSFET) of the MSCSM70VR1M19C1AG device.

**Table 1-1. Absolute Maximum Ratings**

Symbol	Parameter	Maximum Ratings	Unit
$V_{DSS}$	Drain-Source voltage	700	V
$I_D$	Continuous drain current	$T_C = 25\text{ }^\circ\text{C}$	124 <sup>1</sup>
		$T_C = 80\text{ }^\circ\text{C}$	98 <sup>1</sup>
$I_{DM}$	Pulsed drain current	250	
$V_{GS}$	Gate-Source voltage	-10/23	V
$R_{DS(on)}$	Drain-Source ON resistance	19	m $\Omega$
$P_D$	Power dissipation	$T_C = 25\text{ }^\circ\text{C}$	365

**Note:**

1. Specification of SiC MOSFET device but output current must be limited due to size of power connectors.

The following table lists the electrical characteristics (per SiC MOSFET) of the MSCSM70VR1M19C1AG device.

**Table 1-2. Electrical Characteristics**

Symbol	Characteristic	Test Conditions	Min.	Typ.	Max.	Unit
$I_{DSS}$	Zero gate voltage drain current	$V_{GS} = 0V$ ; $V_{DS} = 700V$	—	—	100	$\mu\text{A}$
$R_{DS(on)}$	Drain-Source on resistance	$V_{GS} = 20V$ $I_D = 40A$	—	15	19	m $\Omega$
		$T_J = 175\text{ }^\circ\text{C}$	—	18.8	—	
$V_{GS(th)}$	Gate threshold voltage	$V_{GS} = V_{DS}$ ; $I_D = 4\text{ mA}$	1.9	2.4	—	V
$I_{GSS}$	Gate-Source leakage current	$V_{GS} = 20V$ ; $V_{DS} = 0V$	—	—	150	nA

The following table lists the dynamic characteristics (per SiC MOSFET) of the MSCSM70VR1M19C1AG device.

**Table 1-3. Dynamic Characteristics**

Symbol	Characteristic	Test Conditions	Min.	Typ.	Max.	Unit	
$C_{iss}$	Input capacitance	$V_{GS} = 0V$	—	4500	—	pF	
$C_{oss}$	Output capacitance	$V_{DS} = 700V$	—	510	—		
$C_{rss}$	Reverse transfer capacitance	$f = 1\text{ MHz}$	—	29	—		
$Q_g$	Total gate charge	$V_{GS} = -5V/20V$	—	215	—	nC	
$Q_{gs}$	Gate-source charge	$V_{Bus} = 470V$	—	58	—		
$Q_{gd}$	Gate-drain charge	$I_D = 40A$	—	35	—		
$T_{d(on)}$	Turn-on delay time	$V_{GS} = -5V/20V$	$T_J = 150\text{ }^\circ\text{C}$	—	40	—	ns
$T_r$	Rise time	$V_{Bus} = 400V$		—	35	—	
$T_{d(off)}$	Turn-off delay time	$I_D = 80A$		—	50	—	
$T_f$	Fall time	$R_{GON} = 27\Omega$ $R_{GOFF} = 4.7\Omega$		—	20	—	
$E_{on}$	Turn-on energy	$V_{GS} = -5V/20V$	$T_J = 150\text{ }^\circ\text{C}$	—	545	—	$\mu\text{J}$
$E_{off}$	Turn-off energy	$V_{Bus} = 400V$ $I_D = 80A$ $R_{GON} = 27\Omega$ $R_{GOFF} = 4.7\Omega$	$T_J = 150\text{ }^\circ\text{C}$	—	186	—	
$R_{Gint}$	Internal gate resistance		—	0.69	—	$\Omega$	
$R_{thJC}$	Junction-to-case thermal resistance		—	—	0.41	$^\circ\text{C/W}$	

The following table lists the body diode ratings and characteristics (per SiC MOSFET) of the MSCSM70VR1M19C1AG device.

**Table 1-4. Body Diode Ratings and Characteristics**

Symbol	Characteristic	Test Conditions	Min.	Typ.	Max.	Unit
$V_{SD}$	Diode forward voltage	$V_{GS} = 0V; I_{SD} = 40A$	—	3.4	—	V
		$V_{GS} = -5V; I_{SD} = 40A$	—	3.8	—	
$t_{rr}$	Reverse recovery time	$I_{SD} = 40A$	—	38	—	ns
$Q_{rr}$	Reverse recovery charge	$V_{GS} = -5V$	—	318	—	nC
$I_{rr}$	Reverse recovery current	$V_R = 400V$ $di_F/dt = 1000\text{ A}/\mu\text{s}$	—	14.8	—	A

### 1.2 SiC Diode Ratings and Characteristics (Per SiC Diode)

The following table lists the SiC diode ratings and characteristics of the MSCSM70VR1M19C1AG device.

**Table 1-5. SiC Diode Ratings and Characteristics**

Symbol	Characteristic	Test Conditions		Min.	Typ.	Max.	Unit
$V_{RRM}$	Peak repetitive reverse voltage			—	—	1200	V
$I_{RM}$	Reverse leakage current	$V_R = 1200V$	$T_J = 25\text{ }^\circ\text{C}$	—	15	200	$\mu\text{A}$
			$T_J = 175\text{ }^\circ\text{C}$	—	250	—	
$I_F$	DC Forward current	$T_C = 100\text{ }^\circ\text{C}$		—	50	—	A
$V_F$	Diode forward voltage	$I_F = 50A$	$T_J = 25\text{ }^\circ\text{C}$	—	1.5	1.8	V
			$T_J = 175\text{ }^\circ\text{C}$	—	2.1	—	
$Q_C$	Total capacitive charge	$V_R = 600V$		—	224	—	nC
C	Total capacitance	$f = 1\text{ MHz}, V_R = 400V$		—	246	—	pF
		$f = 1\text{ MHz}, V_R = 800V$		—	182	—	
$R_{thJC}$	Junction-to-case thermal resistance			—	—	0.56	$^\circ\text{C/W}$

### 1.3 Thermal and Package Characteristics

The following table lists the thermal and package characteristics of the MSCSM70VR1M19C1AG device.

**Table 1-6. Thermal and Package Characteristics**

Symbol	Characteristic	Min.	Max.	Unit		
V <sub>ISOL</sub>	RMS isolation voltage, any terminal to case t = 1 min, 50 Hz/60 Hz	4000	—	V		
T <sub>J</sub>	Operating junction temperature range	−40	175	°C		
T <sub>JOP</sub>	Recommended junction temperature under switching conditions	−40	T <sub>Jmax</sub> −25			
T <sub>STG</sub>	Storage temperature range	−40	125			
T <sub>C</sub>	Operating case temperature	−40	125			
Torque	Mounting torque	To heatsink	M4	2	3	N.m
Wt	Package weight	—	80			g

### 1.4 Typical SiC MOSFET Performance Curve

The following figures show the SiC MOSFET performance curves of the MSCSM70VR1M19C1AG device.

**Figure 1-1. Maximum Thermal Impedance**

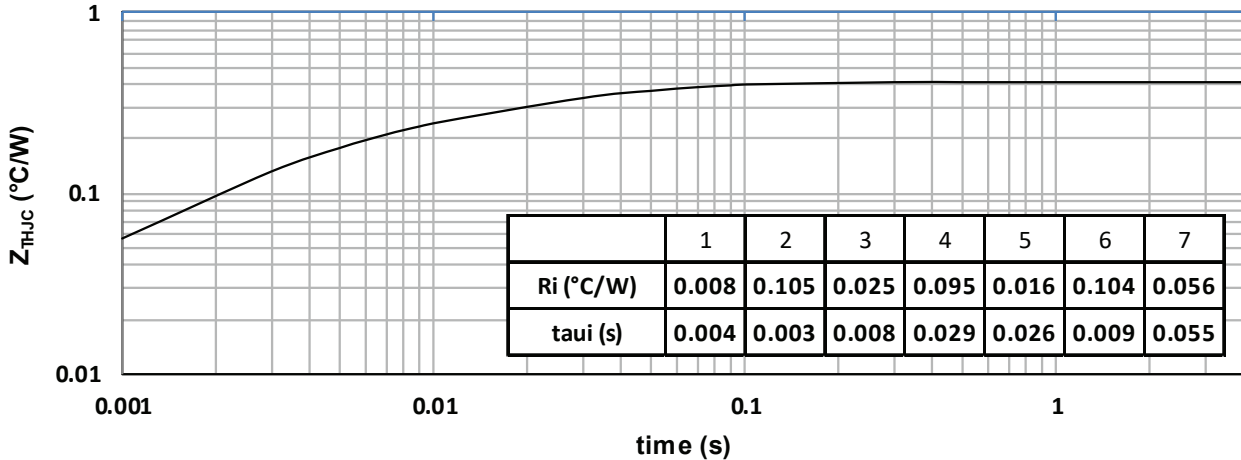

**Figure 1-2. Output Characteristics, T<sub>J</sub> = 25 °C**

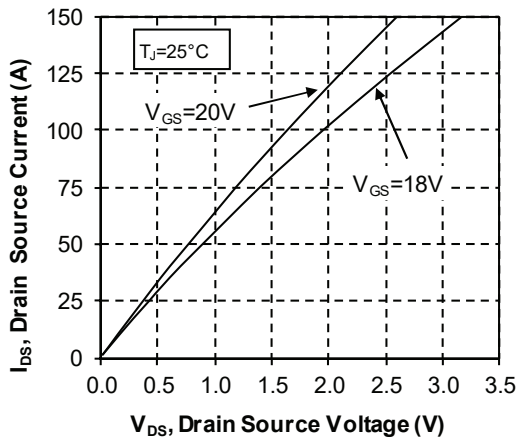

**Figure 1-3. Output Characteristics, T<sub>J</sub> = 175 °C**

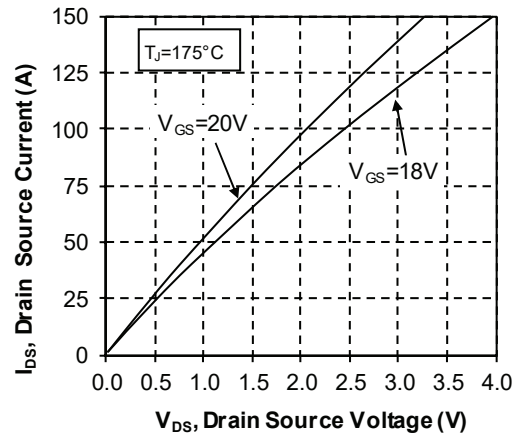

**Figure 1-4. Normalized R<sub>DS(on)</sub> vs. Temperature**

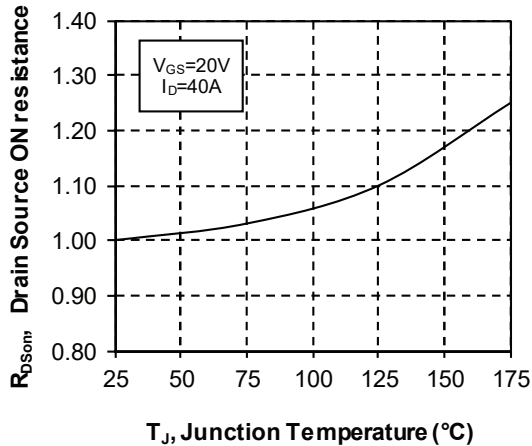

**Figure 1-5. Transfer Characteristics**

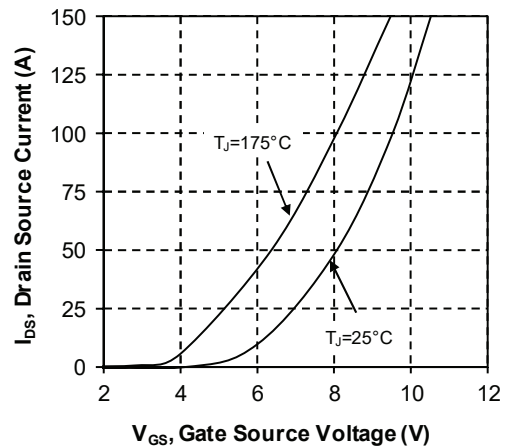

**Figure 1-6. Switching Energy vs. Current**

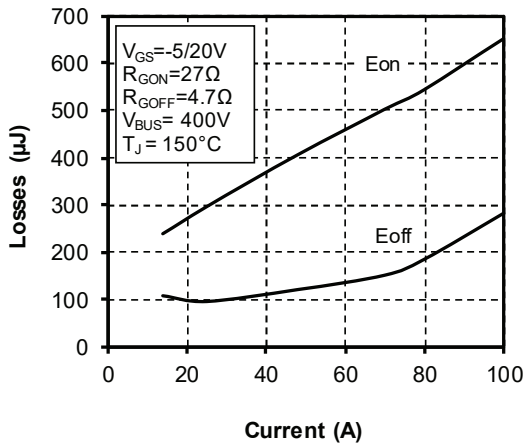

**Figure 1-7. Turn On Energy vs.  $R_g$**

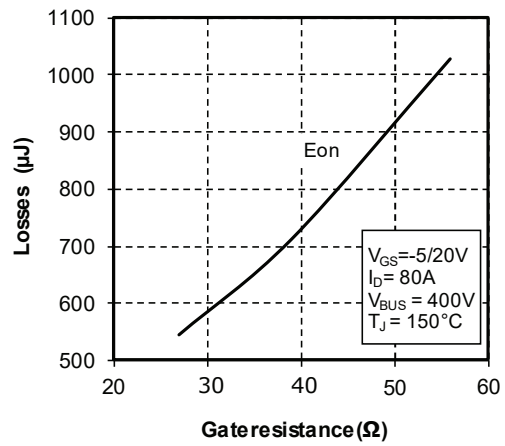

**Figure 1-8. Capacitance vs. Drain Source Voltage**

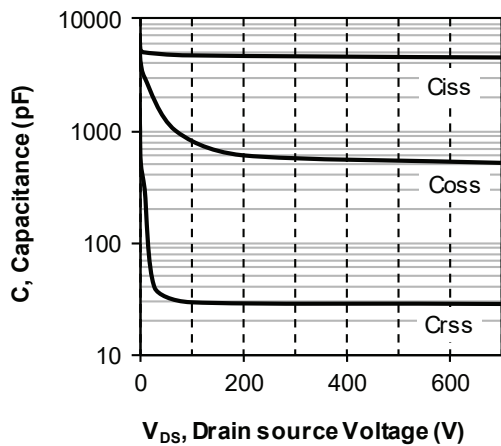

**Figure 1-9. Gate Charge vs. Gate Source Voltage**

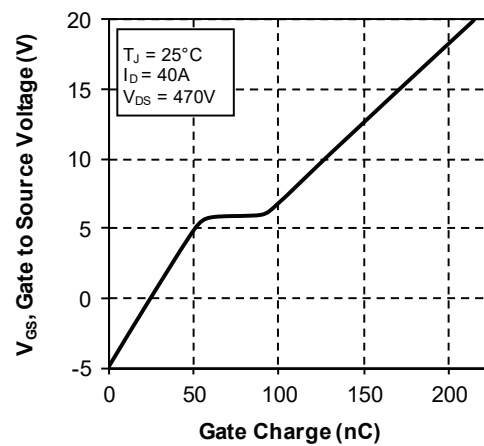

**Figure 1-10. Body Diode Characteristics,  $T_J = 25^\circ\text{C}$**

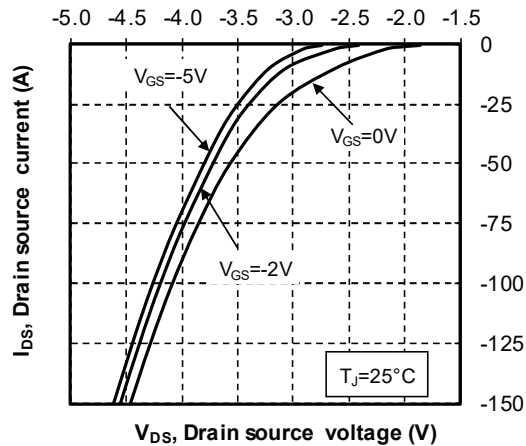

**Figure 1-11. 3<sup>rd</sup> Quadrant Characteristics,  $T_J = 25^\circ\text{C}$**

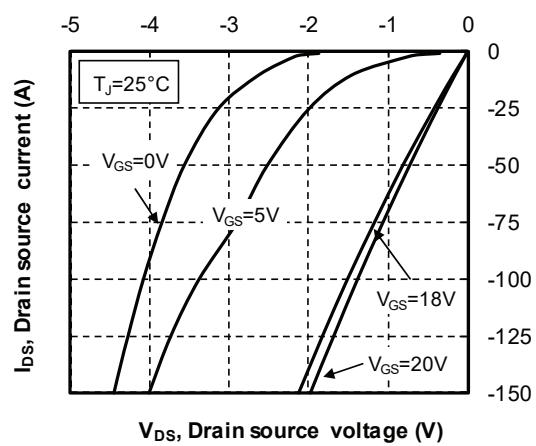



# MSCSM70VR1M19C1AG

## Electrical Specifications

Figure 1-12. Body Diode Characteristics,  $T_J = 175^\circ\text{C}$

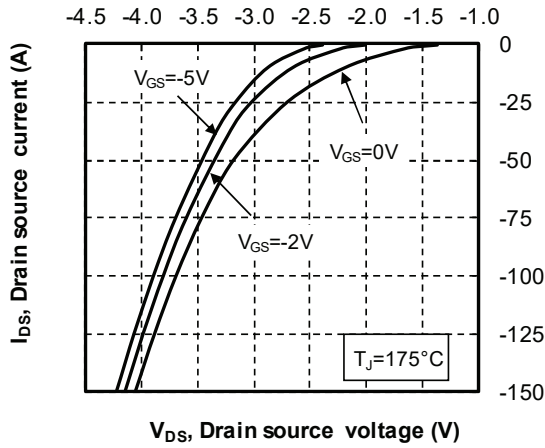

Figure 1-13. 3<sup>rd</sup> Quadrant Characteristics,  $T_J = 175^\circ\text{C}$

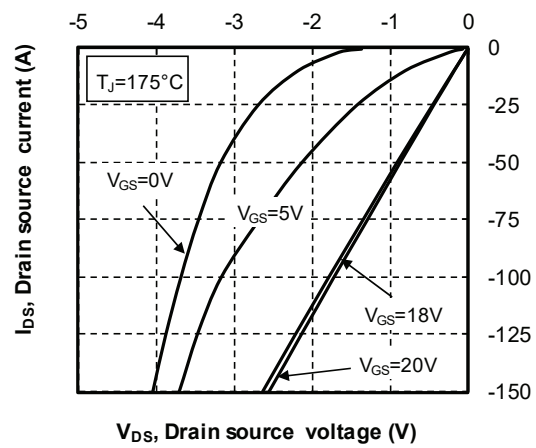

Figure 1-14. Operating Frequency vs Drain Current

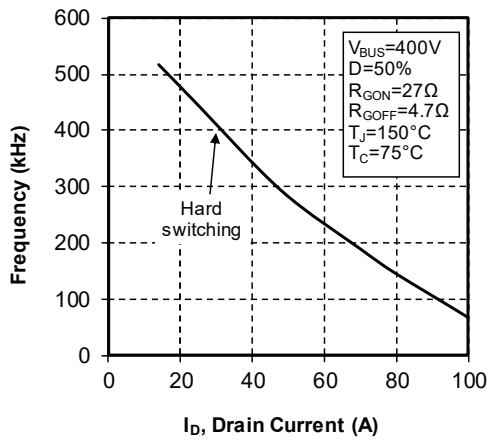
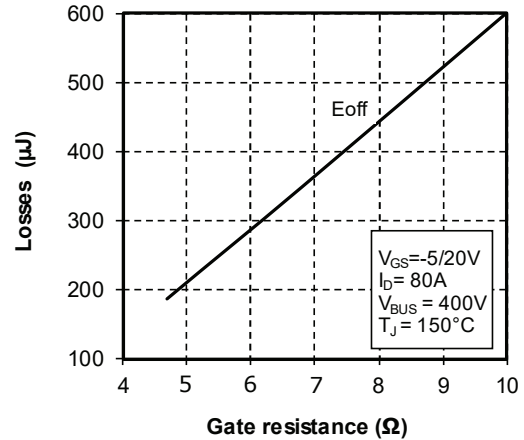

Figure 1-15. Turn Off Energy vs. Rg



### 1.5 Typical SiC Diode Performance Curve

The following figures show the SiC diode performance curves of the MSCSM70VR1M19C1AG device.

**Figure 1-16. Maximum Thermal Impedance**

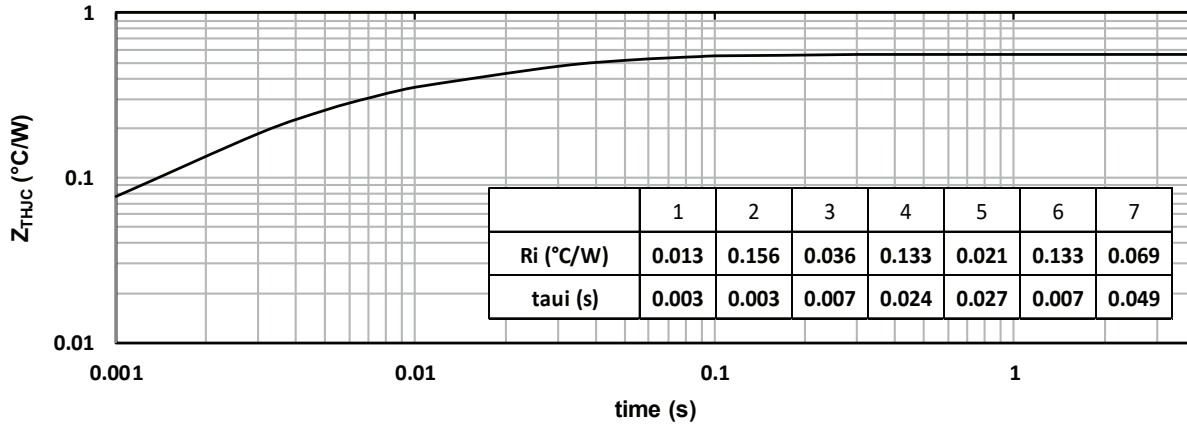

**Figure 1-17. Forward Characteristics**

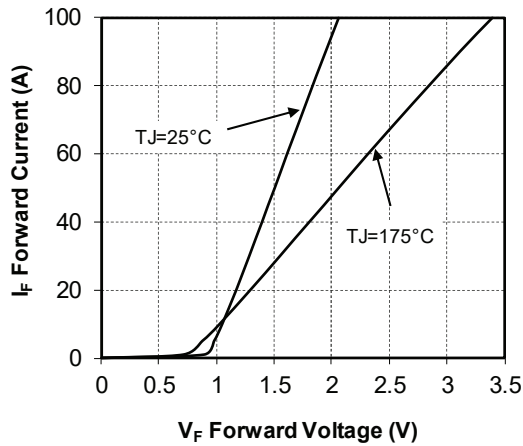

**Figure 1-18. Capacitance vs. Reverse Voltage**

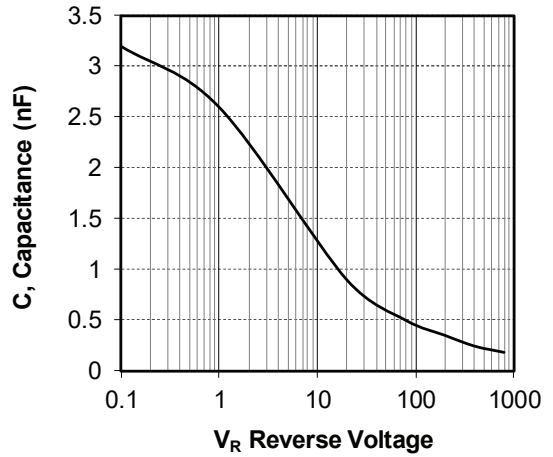

## 2. Package Specifications

The following section shows the package specification of the MSCSM70VR1M19C1AG device.

### 2.1 Package Outline

The following figure shows the package outline drawing of the MSCSM70VR1M19C1AG device. The dimensions in the following figure are in millimeters.

Figure 2-1. Package Outline Drawing

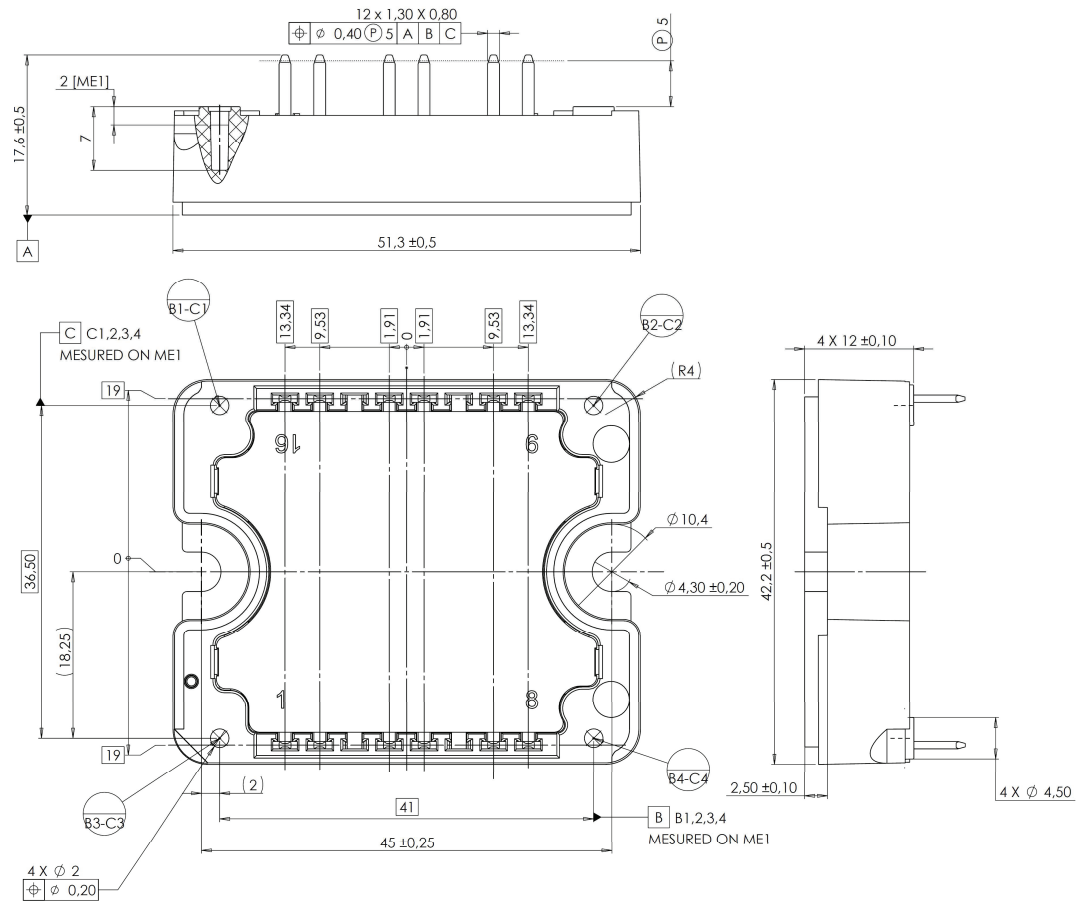

**Note:** See [AN3500A—Mounting Instructions for SP1F and SP3F Power Modules](#) for more information.

### 3. Revision History

Revision	Date	Description
A	08/2022	Initial Revision

## Microchip Information

---

### The Microchip Website

---

Microchip provides online support via our website at [www.microchip.com/](http://www.microchip.com/). This website is used to make files and information easily available to customers. Some of the content available includes:

- **Product Support** – Data sheets and errata, application notes and sample programs, design resources, user's guides and hardware support documents, latest software releases and archived software
- **General Technical Support** – Frequently Asked Questions (FAQs), technical support requests, online discussion groups, Microchip design partner program member listing
- **Business of Microchip** – Product selector and ordering guides, latest Microchip press releases, listing of seminars and events, listings of Microchip sales offices, distributors and factory representatives

### Product Change Notification Service

---

Microchip's product change notification service helps keep customers current on Microchip products. Subscribers will receive email notification whenever there are changes, updates, revisions or errata related to a specified product family or development tool of interest.

To register, go to [www.microchip.com/pcn](http://www.microchip.com/pcn) and follow the registration instructions.

### Customer Support

---

Users of Microchip products can receive assistance through several channels:

- Distributor or Representative
- Local Sales Office
- Embedded Solutions Engineer (ESE)
- Technical Support

Customers should contact their distributor, representative or ESE for support. Local sales offices are also available to help customers. A listing of sales offices and locations is included in this document.

Technical support is available through the website at: [www.microchip.com/support](http://www.microchip.com/support)

### Microchip Devices Code Protection Feature

---

Note the following details of the code protection feature on Microchip products:

- Microchip products meet the specifications contained in their particular Microchip Data Sheet.
- Microchip believes that its family of products is secure when used in the intended manner, within operating specifications, and under normal conditions.
- Microchip values and aggressively protects its intellectual property rights. Attempts to breach the code protection features of Microchip product is strictly prohibited and may violate the Digital Millennium Copyright Act.
- Neither Microchip nor any other semiconductor manufacturer can guarantee the security of its code. Code protection does not mean that we are guaranteeing the product is "unbreakable". Code protection is constantly evolving. Microchip is committed to continuously improving the code protection features of our products.

### Legal Notice

---

This publication and the information herein may be used only with Microchip products, including to design, test, and integrate Microchip products with your application. Use of this information in any other manner violates these terms. Information regarding device applications is provided only for your convenience and may be superseded

by updates. It is your responsibility to ensure that your application meets with your specifications. Contact your local Microchip sales office for additional support or, obtain additional support at [www.microchip.com/en-us/support/design-help/client-support-services](http://www.microchip.com/en-us/support/design-help/client-support-services).

THIS INFORMATION IS PROVIDED BY MICROCHIP "AS IS". MICROCHIP MAKES NO REPRESENTATIONS OR WARRANTIES OF ANY KIND WHETHER EXPRESS OR IMPLIED, WRITTEN OR ORAL, STATUTORY OR OTHERWISE, RELATED TO THE INFORMATION INCLUDING BUT NOT LIMITED TO ANY IMPLIED WARRANTIES OF NON-INFRINGEMENT, MERCHANTABILITY, AND FITNESS FOR A PARTICULAR PURPOSE, OR WARRANTIES RELATED TO ITS CONDITION, QUALITY, OR PERFORMANCE.

IN NO EVENT WILL MICROCHIP BE LIABLE FOR ANY INDIRECT, SPECIAL, PUNITIVE, INCIDENTAL, OR CONSEQUENTIAL LOSS, DAMAGE, COST, OR EXPENSE OF ANY KIND WHATSOEVER RELATED TO THE INFORMATION OR ITS USE, HOWEVER CAUSED, EVEN IF MICROCHIP HAS BEEN ADVISED OF THE POSSIBILITY OR THE DAMAGES ARE FORESEEABLE. TO THE FULLEST EXTENT ALLOWED BY LAW, MICROCHIP'S TOTAL LIABILITY ON ALL CLAIMS IN ANY WAY RELATED TO THE INFORMATION OR ITS USE WILL NOT EXCEED THE AMOUNT OF FEES, IF ANY, THAT YOU HAVE PAID DIRECTLY TO MICROCHIP FOR THE INFORMATION.

Use of Microchip devices in life support and/or safety applications is entirely at the buyer's risk, and the buyer agrees to defend, indemnify and hold harmless Microchip from any and all damages, claims, suits, or expenses resulting from such use. No licenses are conveyed, implicitly or otherwise, under any Microchip intellectual property rights unless otherwise stated.

## Trademarks

---

The Microchip name and logo, the Microchip logo, Adaptec, AVR, AVR logo, AVR Freaks, BesTime, BitCloud, CryptoMemory, CryptoRF, dsPIC, flexPWR, HELDO, IGLOO, JukeBlox, KeeLoq, Kleer, LANCheck, LinkMD, maXStylus, maXTouch, MediaLB, megaAVR, Microsemi, Microsemi logo, MOST, MOST logo, MPLAB, OptoLyzer, PIC, picoPower, PICSTART, PIC32 logo, PolarFire, Prochip Designer, QTouch, SAM-BA, SenGenuity, SpyNIC, SST, SST Logo, SuperFlash, Symmetricom, SyncServer, Tachyon, TimeSource, tinyAVR, UNI/O, Vectron, and XMEGA are registered trademarks of Microchip Technology Incorporated in the U.S.A. and other countries.

AgileSwitch, APT, ClockWorks, The Embedded Control Solutions Company, EtherSynch, Flashtec, Hyper Speed Control, HyperLight Load, Libero, motorBench, mTouch, Powermite 3, Precision Edge, ProASIC, ProASIC Plus, ProASIC Plus logo, Quiet- Wire, SmartFusion, SyncWorld, Temux, TimeCesium, TimeHub, TimePictra, TimeProvider, TrueTime, and ZL are registered trademarks of Microchip Technology Incorporated in the U.S.A.

Adjacent Key Suppression, AKS, Analog-for-the-Digital Age, Any Capacitor, AnyIn, AnyOut, Augmented Switching, BlueSky, BodyCom, Clockstudio, CodeGuard, CryptoAuthentication, CryptoAutomotive, CryptoCompanion, CryptoController, dsPICDEM, dsPICDEM.net, Dynamic Average Matching, DAM, ECAN, Espresso T1S, EtherGREEN, GridTime, IdealBridge, In-Circuit Serial Programming, ICSP, INICnet, Intelligent Paralleling, IntellIMOS, Inter-Chip Connectivity, JitterBlocker, Knob-on-Display, KoD, maxCrypto, maxView, memBrain, Mindi, MiWi, MPASM, MPF, MPLAB Certified logo, MPLIB, MPLINK, MultiTRAK, NetDetach, Omniscient Code Generation, PICDEM, PICDEM.net, PICkit, PICtail, PowerSmart, PureSilicon, QMatrix, REAL ICE, Ripple Blocker, RTAX, RTG4, SAM-ICE, Serial Quad I/O, simpleMAP, SimpliPHY, SmartBuffer, SmartHLS, SMART-I.S., storClad, SQL, SuperSwitcher, SuperSwitcher II, Switchtec, SynchroPHY, Total Endurance, Trusted Time, TSHARC, USBCheck, VariSense, VectorBlox, VeriPHY, ViewSpan, WiperLock, XpressConnect, and ZENA are trademarks of Microchip Technology Incorporated in the U.S.A. and other countries.

SQTP is a service mark of Microchip Technology Incorporated in the U.S.A.

The Adaptec logo, Frequency on Demand, Silicon Storage Technology, and Symmcom are registered trademarks of Microchip Technology Inc. in other countries.

GestIC is a registered trademark of Microchip Technology Germany II GmbH & Co. KG, a subsidiary of Microchip Technology Inc., in other countries.

All other trademarks mentioned herein are property of their respective companies.

© 2022, Microchip Technology Incorporated and its subsidiaries. All Rights Reserved.

ISBN: 978-1-6683-1023-6

## Quality Management System

---

For information regarding Microchip's Quality Management Systems, please visit [www.microchip.com/quality](http://www.microchip.com/quality).

## Worldwide Sales and Service

AMERICAS	ASIA/PACIFIC	ASIA/PACIFIC	EUROPE
<p><b>Corporate Office</b> 2355 West Chandler Blvd. Chandler, AZ 85224-6199 Tel: 480-792-7200 Tel: 480-792-7277 Technical Support: <a href="http://www.microchip.com/support">www.microchip.com/support</a> Web Address: <a href="http://www.microchip.com">www.microchip.com</a></p> <p><b>Atlanta</b> Duluth, GA Tel: 678-957-9614 Fax: 678-957-1455</p> <p><b>Austin, TX</b> Tel: 512-257-3370</p> <p><b>Boston</b> Westborough, MA Tel: 774-760-0087 Fax: 774-760-0088</p> <p><b>Chicago</b> Itasca, IL Tel: 630-285-0071 Fax: 630-285-0075</p> <p><b>Dallas</b> Addison, TX Tel: 972-818-7423 Fax: 972-818-2924</p> <p><b>Detroit</b> Novi, MI Tel: 248-848-4000</p> <p><b>Houston, TX</b> Tel: 281-894-5983</p> <p><b>Indianapolis</b> Noblesville, IN Tel: 317-773-8323 Fax: 317-773-5453 Tel: 317-536-2380</p> <p><b>Los Angeles</b> Mission Viejo, CA Tel: 949-462-9523 Fax: 949-462-9608 Tel: 951-273-7800</p> <p><b>Raleigh, NC</b> Tel: 919-844-7510</p> <p><b>New York, NY</b> Tel: 631-435-6000</p> <p><b>San Jose, CA</b> Tel: 408-735-9110 Tel: 408-436-4270</p> <p><b>Canada - Toronto</b> Tel: 905-695-1980 Fax: 905-695-2078</p>	<p><b>Australia - Sydney</b> Tel: 61-2-9868-6733</p> <p><b>China - Beijing</b> Tel: 86-10-8569-7000</p> <p><b>China - Chengdu</b> Tel: 86-28-8665-5511</p> <p><b>China - Chongqing</b> Tel: 86-23-8980-9588</p> <p><b>China - Dongguan</b> Tel: 86-769-8702-9880</p> <p><b>China - Guangzhou</b> Tel: 86-20-8755-8029</p> <p><b>China - Hangzhou</b> Tel: 86-571-8792-8115</p> <p><b>China - Hong Kong SAR</b> Tel: 852-2943-5100</p> <p><b>China - Nanjing</b> Tel: 86-25-8473-2460</p> <p><b>China - Qingdao</b> Tel: 86-532-8502-7355</p> <p><b>China - Shanghai</b> Tel: 86-21-3326-8000</p> <p><b>China - Shenyang</b> Tel: 86-24-2334-2829</p> <p><b>China - Shenzhen</b> Tel: 86-755-8864-2200</p> <p><b>China - Suzhou</b> Tel: 86-186-6233-1526</p> <p><b>China - Wuhan</b> Tel: 86-27-5980-5300</p> <p><b>China - Xian</b> Tel: 86-29-8833-7252</p> <p><b>China - Xiamen</b> Tel: 86-592-2388138</p> <p><b>China - Zhuhai</b> Tel: 86-756-3210040</p>	<p><b>India - Bangalore</b> Tel: 91-80-3090-4444</p> <p><b>India - New Delhi</b> Tel: 91-11-4160-8631</p> <p><b>India - Pune</b> Tel: 91-20-4121-0141</p> <p><b>Japan - Osaka</b> Tel: 81-6-6152-7160</p> <p><b>Japan - Tokyo</b> Tel: 81-3-6880-3770</p> <p><b>Korea - Daegu</b> Tel: 82-53-744-4301</p> <p><b>Korea - Seoul</b> Tel: 82-2-554-7200</p> <p><b>Malaysia - Kuala Lumpur</b> Tel: 60-3-7651-7906</p> <p><b>Malaysia - Penang</b> Tel: 60-4-227-8870</p> <p><b>Philippines - Manila</b> Tel: 63-2-634-9065</p> <p><b>Singapore</b> Tel: 65-6334-8870</p> <p><b>Taiwan - Hsin Chu</b> Tel: 886-3-577-8366</p> <p><b>Taiwan - Kaohsiung</b> Tel: 886-7-213-7830</p> <p><b>Taiwan - Taipei</b> Tel: 886-2-2508-8600</p> <p><b>Thailand - Bangkok</b> Tel: 66-2-694-1351</p> <p><b>Vietnam - Ho Chi Minh</b> Tel: 84-28-5448-2100</p>	<p><b>Austria - Wels</b> Tel: 43-7242-2244-39 Fax: 43-7242-2244-393</p> <p><b>Denmark - Copenhagen</b> Tel: 45-4485-5910 Fax: 45-4485-2829</p> <p><b>Finland - Espoo</b> Tel: 358-9-4520-820</p> <p><b>France - Paris</b> Tel: 33-1-69-53-63-20 Fax: 33-1-69-30-90-79</p> <p><b>Germany - Garching</b> Tel: 49-8931-9700</p> <p><b>Germany - Haan</b> Tel: 49-2129-3766400</p> <p><b>Germany - Heilbronn</b> Tel: 49-7131-72400</p> <p><b>Germany - Karlsruhe</b> Tel: 49-721-625370</p> <p><b>Germany - Munich</b> Tel: 49-89-627-144-0 Fax: 49-89-627-144-44</p> <p><b>Germany - Rosenheim</b> Tel: 49-8031-354-560</p> <p><b>Israel - Ra'anana</b> Tel: 972-9-744-7705</p> <p><b>Italy - Milan</b> Tel: 39-0331-742611 Fax: 39-0331-466781</p> <p><b>Italy - Padova</b> Tel: 39-049-7625286</p> <p><b>Netherlands - Drunen</b> Tel: 31-416-690399 Fax: 31-416-690340</p> <p><b>Norway - Trondheim</b> Tel: 47-72884388</p> <p><b>Poland - Warsaw</b> Tel: 48-22-3325737</p> <p><b>Romania - Bucharest</b> Tel: 40-21-407-87-50</p> <p><b>Spain - Madrid</b> Tel: 34-91-708-08-90 Fax: 34-91-708-08-91</p> <p><b>Sweden - Gothenberg</b> Tel: 46-31-704-60-40</p> <p><b>Sweden - Stockholm</b> Tel: 46-8-5090-4654</p> <p><b>UK - Wokingham</b> Tel: 44-118-921-5800 Fax: 44-118-921-5820</p>