



Mallory Sonalert Products, Inc.

Part #:

**FL1P-8QJ-2
8mm Panel Light**

Sales Outline Drawing

Revision:

B

Specifications:

Panel Hole	8 mm
Voltage Type	AC/DC
LED Color Available	Red, Green, Blue, Yellow, or White
Lens Color	Same as LED
Rated Voltage Available	See table below
Max Current Draw	20 mA
Storage & Operating Temperature	-15 °C to +80 °C
Ingress Protection Rating	IP50
LED Life	70,000 hours
Weight (Typical)	1.6 g
Housing Material	PA66
Termination Type	Flat Blades Quick-Connect Terminal
Terminal Dimensions	2.8mm x 0.6mm x 8mm
Panel Thickness	up to 0.09" (2.3mm)

RoHS Compliant

Dimensions (mm):

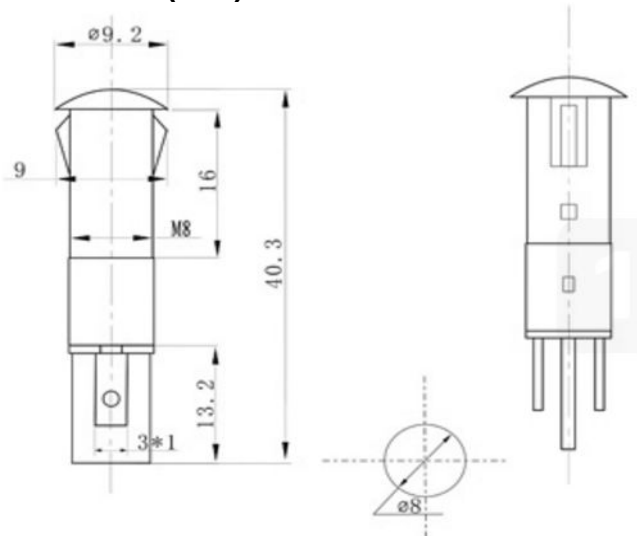

Part Number:

FL1P-8QJ-2-X#V

B=Blue
 G=Green
 R=Red
 Y=Yellow
 W=White

Rated Voltage

Length for reference only.

	Light Intensity	Dominant Wavelength	Viewing Angle
Red	1000 -1500 mcd	622 nm	35°
Green	8000 -10000 mcd	522 nm	60°
Yellow	1000 -1500 mcd	590 nm	35°
Blue	2000 - 3000 mcd	464 nm	35°

Rated Voltage	2 VAC/DC	3 VAC/DC	6 VAC/DC	12 VAC/DC	24 VAC/DC	48 VAC/DC	110 VAC/DC	220 VAC/DC	380 VAC/DC
Red	1.8-2.2V	2.7-3.3V	5.4-6.6V	10.8-13.2V	21.6-26.4V	43.2-52.8V	99-121V	198-242V	342-418V
Green	N/A	3-3.2V	5.4-6.6V	10.8-13.2V	21.6-26.4V	43.2-52.8V	99-121V	198-242V	342-418V
Blue	N/A	3.12-3.2V	5.4-6.6V	10.8-13.2V	21.6-26.4V	43.2-52.8V	99-121V	198-242V	342-418V
Yellow	2-2.2V	2.7-3.3V	5.4-6.6V	10.8-13.2V	21.6-26.4V	43.2-52.8V	99-121V	198-242V	342-418V
White	N/A	3-3.2V	5.4-6.6V	10.8-13.2V	21.6-26.4V	43.2-52.8V	99-121V	198-242V	342-418V