

---

# Vzense DCAM550 ToF Camera User Manual



**DCAM550U**



**DCAM550P**

---

## Table of Contents

1	General Information.....	4
1.1	Terms of Use.....	4
2	Precautions.....	5
2.1	Safe Usage Instructions.....	5
2.2	Power.....	5
2.3	Usage.....	6
2.4	Temperature.....	6
3	Specifications and Requirement.....	7
3.1	General Specifications.....	7
3.2	Electrical Specifications.....	8
3.2.1	Recommended Operating Conditions.....	8
3.2.2	Power Consumption.....	8
3.2.3	Absolute Maximum Ratings.....	8
3.3	DCAM550-P Mechanical Specifications.....	9
3.4	DCAM550-U Mechanical Specifications.....	10
3.5	Optical Specifications.....	11
3.5.1	Field of View.....	11
3.5.2	Wavelength of the VCSEL.....	11
3.6	Working Condition Requirements.....	12
3.6.1	Hardware Requirements.....	12
3.6.2	Software Requirements.....	12
3.6.3	Environmental Requirements.....	12
3.6.4	Coordinate of the Camera System.....	13
4	Interface with Host.....	14
4.1	6pin Connector.....	15
4.2	Type A USB2.0 Connector for DCAM550-U.....	16
4.3	RJ45 Ethernet Connector for DCAM550-P.....	16
4.4	LED indication.....	17
4.5	IP Reset Button for DCAM550-P.....	18
5	Principle of Time of Flight.....	19
5.1	Vzense ToF Principle.....	19
5.2	Noise Factors.....	19
5.2.1	Ambient Light.....	19
5.2	Multipath Propagation.....	19
5.3	Reflectivity of the Target.....	20
5.4	Scattering Effect.....	20
6	Installation.....	21
6.1	Hardware Installation.....	21
6.1.1	USB2.0 Mode Installation (DCAM550-U Only).....	21
6.1.2	USB2.0 External Power Installation (DCAM550-U Only).....	21
6.1.3	100M Ethernet Installation (DCAM550-P Only).....	22
6.1.4	POE Mode Installation.....	23

---

6.1.5	Standalone Mode Installation .....	25
6.2	Software Installation .....	26
6.2.1	How to get .....	26
6.2.2	Graphic Tool on windows.....	26
6.2.3	Frameviewer .....	27
6.3	Firmware Upgrade.....	27
6.4	Product State Machine .....	28
6.5	Software Command Set .....	29
6.6	USB Connection.....	29
7	Features .....	30
7.1	Slave Trigger Mode .....	30
7.2	Range Customization .....	30
7.3	Wide Dynamic Range.....	31
7.4	Data Filtering.....	32
7.5	IR Image.....	32
8	Camera Operation on Frameviewer.....	34
8.1	Main screen.....	34
8.1.1	Image area .....	35
8.1.2	Command and information area .....	35
8.2	Connect devices.....	36
8.3	2D view .....	36
8.3.1	Depth Image.....	36
8.3.2	IR Image .....	37
8.4	3D image store.....	37
8.5	Camera Control .....	38
8.5.1	Mode switch .....	38
8.5.2	Range change.....	38
8.6	WDR .....	39
9	DCAM550 Accessories and Package .....	42
10	Customization Service .....	43
Appendix	.....	43
ROHS Declaration.....	.....	43
Eye Safety Declaration.....	.....	43
Reliability Declaration.....	.....	43
Revision History	.....	43

---

# 1 General Information

The purpose of this document is to familiarize the customer with the correct operation of the Vzense ToF DCAM550 products family. This document provides important information about the camera's features, hardware specification, safe use of the camera, and installation procedures.

DCAM550 product family is a series of products designed by Vzense company. It has two sub-series, DCAM550-U refers to the USB version, DCAM550-P refers to the Power over Ethernet version.

## 1.1 Terms of Use

Vzense offers a 1-year-warranty for this camera.

### Warranty Information

Please do follow the following guidelines when using the Vzense camera:

#### **Do not remove the product's serial number label**

Warranty must be void, if the label is damaged or removed and the serial number can't be read from the camera's registers.

#### **Do not open the camera housing**

Do not open the housing. Touching any internal components may damage the camera.

**Prevent any objects or substances from entering the camera housing. Otherwise the camera may fail or damaged.**

#### **Avoid electromagnetic fields**

Do not use the camera near strong electromagnetic fields. Prevent from electrostatic charging.

#### **Transport in original packaging**

Transport and store the camera in its original packaging only. Do not discard the packaging.

#### **Clean with care**

If you have to clean the housing of the camera, follow the guidelines in the notice as below:

- Use a soft, dry cloth that won't generate static during cleaning;
- To remove tough stains, use a soft cloth dampened with a small amount of neutral detergent(Pure water); after that wipe dry;
- Make sure no any residual detergent after cleaning, before reconnecting the camera to power

#### **Read the manual**

Do read the manual carefully before using the camera.

---

## 2 Precautions

### 2.1 Safe Usage Instructions

	DANGER
	<p><b>Electric Shock Risk</b></p> <p>Non-standard and improper power supplies may result in fire and electric shock. You must confirm the camera power supply used that meets the Safety Extra Low Voltage(SELV) and Limited Power Supply (LPS) requirements.</p>

	CAUTION
	<p><b>Invisible Radiation</b></p> <p>This camera uses laser to work, improper use may damage the eye. Lasers are classified as risk group 1 (low risk) according to EN 60825 which means that the product presents no risk related to exposure limits under normal usage conditions. Eye safety is only guaranteed when the camera is used properly</p>

### 2.2 Power

The DCAM550-U series products can work with either USB power or external DC power.

With USB power, the working distance will be limited by the USB host power ability. Normally the USB2.0 host can supply up to 5V/500mA current. USB3.0 host can supply up to 5V/900mA current. We strongly suggest to use external DC power if you require far distance which more than 4 meters. The DC power can accept 11V~26V power source. For higher than 26V or lower than 11V, the device shall not work well or even be damaged.

The DCAM550-P series products can work with either Power over Ethernet or external DC power.

For PoE power source, the PSE device shall apply the PoE+ standard (802.3at) or above, lower than that may cause the product doesn't work well or even be damaged. The DC power can accept 11V~26V power source. For higher than 26V or lower than 11V, the device shall not work well or even be damaged.

Vzense doesn't produce PoE injector, but we can purchase it from 3<sup>rd</sup> party and ship

---

to customer at original cost.

Below is the PoE+ injector available vendor list.

Vendor	Model Number
H3C	EWPAM2NPOE
TP LINK	TL-POE170S

## 2.3 Usage

Don't try to open the camera housing. Each camera has been calibrated at the factory to achieve precise measurements. Touching internal components may damage the camera and cause calibration data lost.

Incorrect plugging in and unplugging of the camera's power cable can damage the camera. To avoid switch-on surges damaging the camera, please plug in the power cable into the camera's 6-pin connector firstly before getting power supply.

Don't try to change the position of the lens, may cause damage to the camera.

Do store the camera carefully when not in use, in original package the best.

## 2.4 Temperature

To avoid damaging the camera and to achieve best performance, please observe the maximum and minimum housing temperatures in Section 3.1

---

## 3 Specifications and Requirement

### 3.1 General Specifications

Specification	Vzense DCAM550
Technology	ToF (Time-of-flight) Depth Camera
Depth Sensor Resolution and Frame rate	640 x 480(VGA)@30FPS
Output Formats	Depth & IR Map (RAW12)
Depth Sensor Field of View H-Horizontal, V-Vertical(degree)	Typical: H-69° V-51° (customizable, up to H 120° V90°)
Use Range	0.3m ~ 6m(customizable)
Accuracy	<1%
Power Consumption	Average Max. 5W(Ref)
Illumination	940nm ,2 x 2W Vcsel
Dimension(L*W*H)	DCAM550-U: 65mm*65mm*52.7mm DCAM550-P: 65mm*65mm*52.7mm
Weight	DCAM550-U: 265g DCAM550-P: 279g
Power Supply	DCAM550-U: USB or DC Power DCAM550-P: PoE+ or DC Power
Interface	DCAM550-U: USB OTG and RS485 DCAM550-P: Ethernet and RS485
Digital I/O (Exposure Control, Synchronization etc.)	1in/1out Passive Sync Signal
Enclosure Rating	IP42
Working/Storage Temperature	-20°C -50°C/-30°C -70°C
Software	C/C++ SDK
Operation System	Windows 7/8/10, Android, Linux
Cooling	Passive, no fan
Certification	FCC/CE/FDA
Eye safety	Class 1

## 3.2 Electrical Specifications

### 3.2.1 Recommended Operating Conditions

Parameter	Symbol	Conditions	Min	Typ.	Max	Units
DC Power	VDD		11	12	26	V
USB2.0	USB		4.75	5	5.5	V
Digital I/O (Exposure_timing)	Vout	Work mode		5		V
Digital I/O (Ext_Trigger)	Vin		3.3		20	V
RS485			-12		12	V
Operating Temperature	Ta		-20		50	°C
Operating humidity			20		80	%
Storage humidity			20		80	%
Storage temperature			-30		70	°C

### 3.2.2 Power Consumption

Parameter	Conditions	Average	Max	Units
Range 0	350mm-1200mm @30fps	238	334	mA
Range 1	500mm-2800mm@30fps	374	545	mA
Range 2	800mm-4400mm@30fps	438	661	mA
Range 5	1200mm-6000mm@15fps	478	1196	mA

Note: 12V input voltage

### 3.2.3 Absolute Maximum Ratings

This is a stress rating only and functional operation of the devices at those or any other conditions above those indicated in the operation listings of this specification is not promised. Exposure to maximum rating conditions for extended periods may affect device reliability

Parameter	Symbol	Conditions	Min	Typ.	Max	Units
DC Power	VDD		9	12	30	V
USB2.0	USB		-0.3	5	6	V
Digital I/O (Ext_Trigger)	Vin		-0.3		20	V
RS485			-13.2		13.2	V
Operating Temperature	Ta		-20		50	°C



### 3.3 DCAM550-P Mechanical Specifications

This drawing contains information about the dimensions and user mounting location of the ToF Camera.

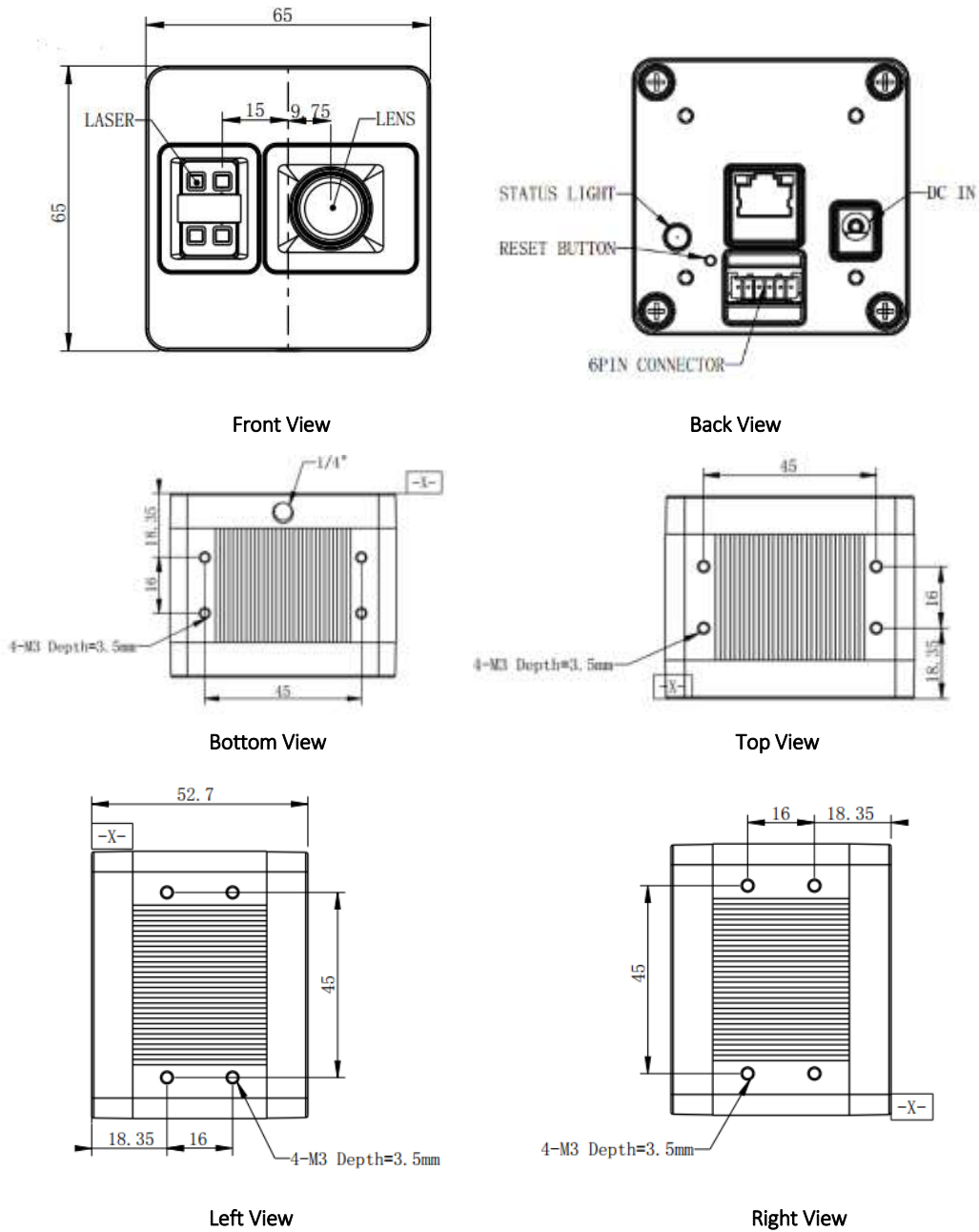

Fig. 3.1: ToF Camera Dimensions

Unit: mm

### 3.4 DCAM550-U Mechanical Specifications

This drawing contains information about the dimensions and user mounting location of the ToF Camera.

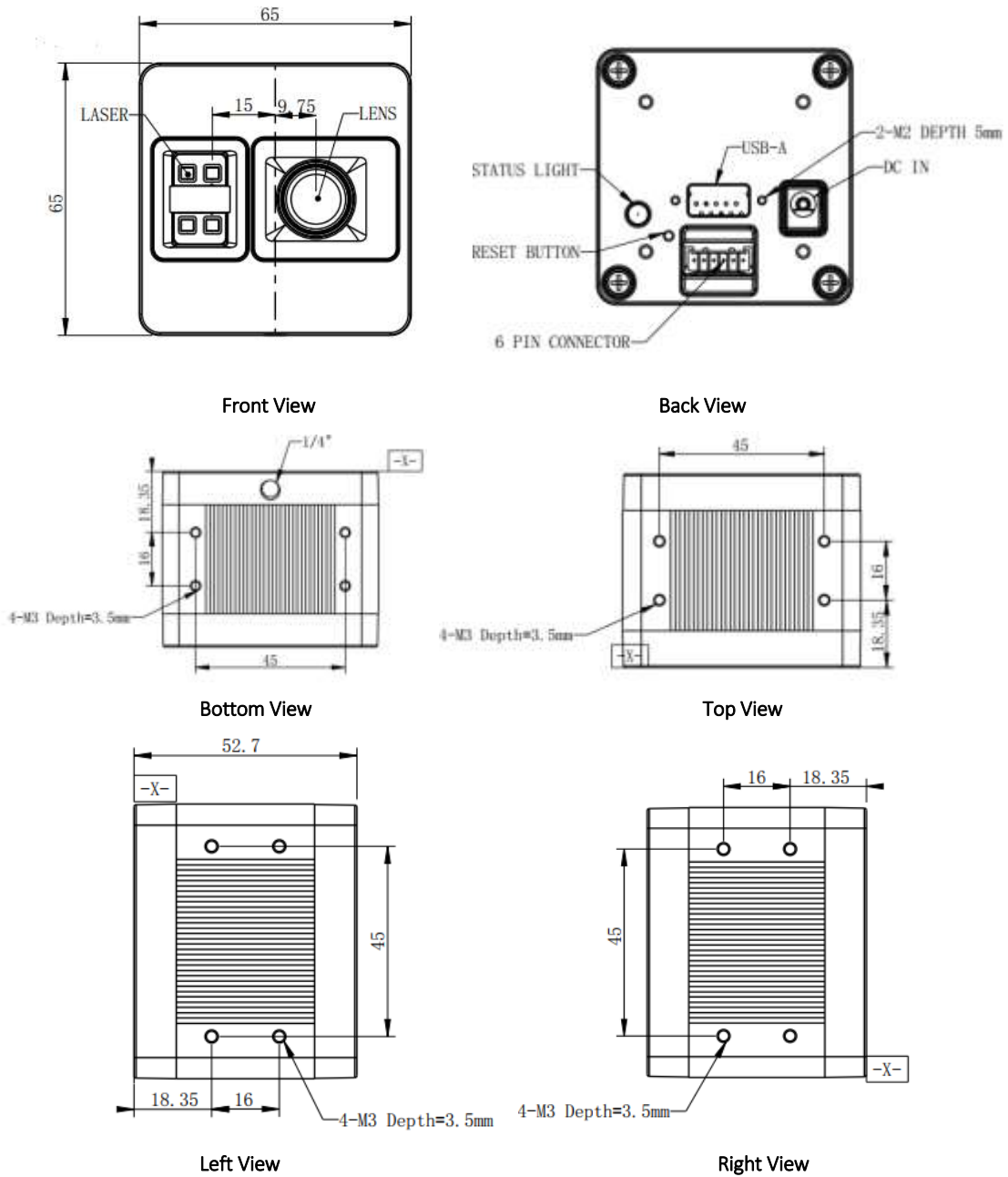

Fig. 3.2: ToF Camera Dimensions

Unit: mm

---

## 3.5 Optical Specifications

### 3.5.1 Field of View

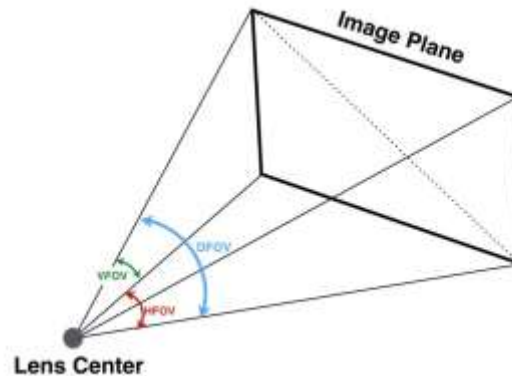

The field of view refers to the view angle of the ToF products. The TOF sensor's aspect ratio is 4:3, typically the horizontal field of view is larger than the vertical field of view. The DFOV (see figure below) is the angle subtended by the diagonal of the camera sensor onto the center of the lens.

The definition of HFOV and VFOV can be exchanged, i. e. we can rotate the camera sensor to have larger FOV at vertical direction.

Typical FOV of DCAM550 Series is  $69^{\circ} \times 51^{\circ}$ , we can do FOV customization if the customer requires, and reasonable NRE fee shall be charged.

### 3.5.2 Wavelength of the VCSEL

All our product are based on VCSEL laser. We have variety choices according to the lens FOV and wavelength. The laser FOV must match to the lens FOV, and the wider FOV products need stronger power, therefore higher power consumption. Even with higher power supplied, the laser power per angle of the wider FOV product may be reduced, so normally the maximum distance of wider FOV products is shorter than narrower FOV products.

As for the wavelength, we have 850nm and 940nm laser selection. Because of the silicon process based ToF sensor, the ToF sensor's QE of 850nm is much better than it of 940nm. That means normally 850nm product can reach longer distance or the same distance with lower power consumption;

But the 940nm wavelength has better performance under strong sunlight, especially when the ambient light is stronger than 20K LUX.

Below are the laser choices we can provide, if you have other needs, please let us know.

H69°, V51°--- 2W, 940nm

H110°, V85°--- 2W, 850nm

---

## 3.6 Working Condition Requirements

### 3.6.1 Hardware Requirements

#### **DCAM550-U:**

- TYPE A to TYPE A USB cable (Included in package)
- 6 pin cable which provide RS485, I/O signals. (Not included in package)
- DC Power Adaptor. (Included in package)

#### **DCAM550-P:**

- CAT5 Ethernet cable (Included in package)
- 6 pin cable which provide power and interface with host. (Not included in package)
- DC Power Adaptor. (Included in package)

Or

- PoE+ Power Supplier. (Not included in package)

### 3.6.2 Software Requirements

#### **Operating system**

- 32-bit Windows 7/10
- 64-bit Windows 7/10 (recommended)
- Linux (x86, x64)
- Android 5.0 or above

#### **Vzense ToF Driver**

The Vzense ToF Driver software is available for Windows, Linux and Android operating systems and includes the following:

- SDK code
- Sample code
- Software user manual

### 3.6.3 Environmental Requirements

#### **Temperature and Humidity**

Housing temperature during operation:	-20–50 °C
Humidity during operation:	20–80 %, relative
Storage temperature:	-30–70 °C
Storage humidity:	20–80 %, relative

#### **Heat Dissipation**

Users can provide sufficient heat dissipation, like mounting the camera on a

substantial, thermally conductive component that can act as a heat sink. Or a fan can be used to provide an air flow over the camera.

### 3.6.4 Coordinate of the Camera System

There are two coordinate system need to be understood, one is camera coordinate system (CCS), one is world coordinate system (WCS).

CCS: CCS describe the two-dimensional data, the origin of coordinates is the optic center.

WCS: WCS describe the three-dimensional information.

The CCS data can switch to the WCS data using the camera internal parameters.

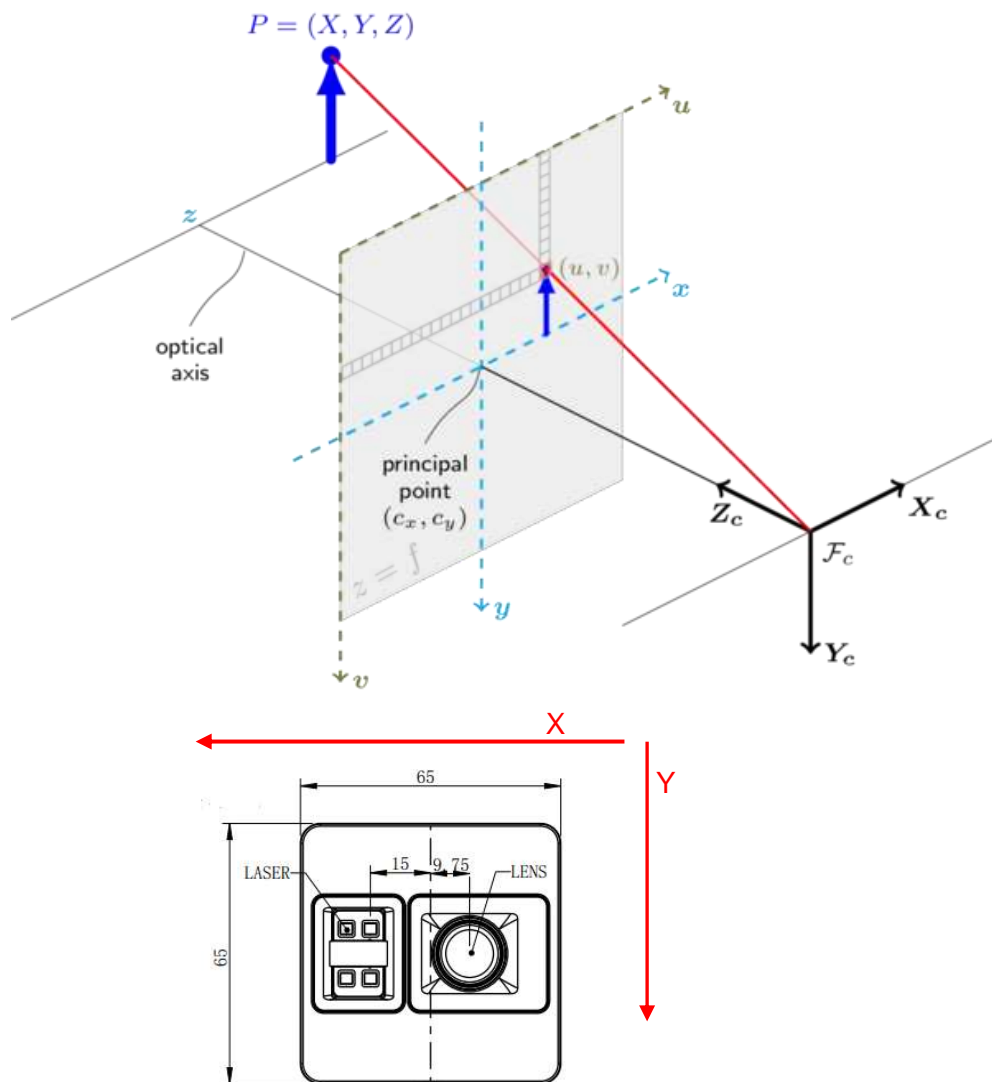

**Fig. 3.3: Origin of the Coordinate System**

Meshlab and CloudCompare tools are recommended to analyze the point cloud data saved by Vzense software or SDK method.

---

## 4 Interface with Host

DCAM550-U ToF Camera is equipped with Type-A, LED, 6pin connector, DC JACK at the back of its housing as shown in below figure.

For more information about pin assignments and connector types, see the following sections.

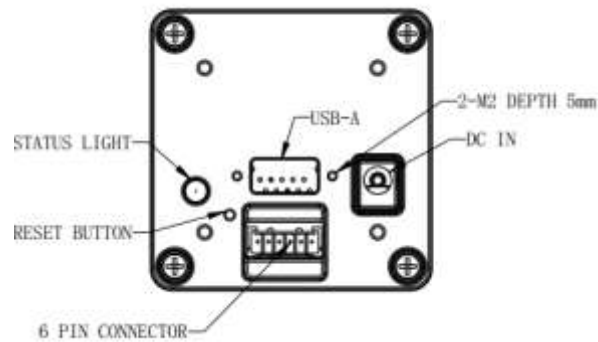

Fig. 4.1: Camera Connectors

DCAM550-P ToF Camera is equipped with RJ45, LED, 6pin connector, IP reset button at the back of its housing as shown in below figure.

For more information about pin assignments and connector types, see the following sections.

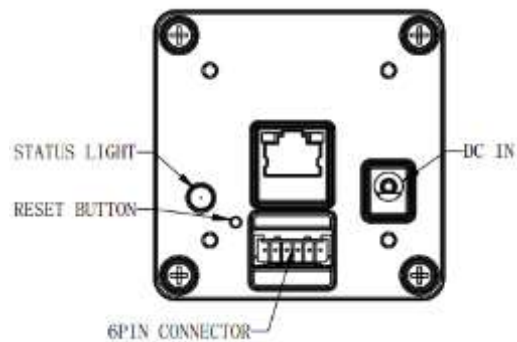

Fig. 4.2: Camera Connectors

## 4.1 6pin Connector

The 6pin connector includes the one physical input signals and one physical output signal, RS485 signal.

The pin assignments and pin numbering for the receptacle are as shown in below table.

The connector of the camera is a Molex receptacle, part number 535170630. The recommended mating connector is a Molex plug, part number 511030600.

Pin	Line Color	Designation
1	BN	RS485-A
2	GN	RS485-B
3	WH	Ext_Trigger
4	YE	Exposure_timing
5	BK	GND
6	RD	Ext_OUT

### Pin Description

Pin	Designation	Direction	Description
1	RS485-A	I/O	RS485-A
2	RS485-B	I/O	RS485-B
3	Ext_Trigger	INPUT	External trigger input (3.3V-20V)
4	Exposure_timing	OUTPUT	Control signal output 1
5	GND	GND	System ground
6	Ext_OUT	OUTPUT	Control signal output from processor

### Hardware Trigger Function

Hardware trigger mode is available only when the camera works at slave mode, in slave mode the camera will wait for the hardware trigger signal on Ext\_Trigger.

The EXT\_Trigger signal is to driver the MOSFET, External input trigger signal voltage should range 3.3V-20V, driving current ability should be more than 5mA;

You can use input pin Ext\_Trigger to send a hardware trigger signal to the camera.

The hardware trigger can be used to trigger the acquisition start. **A hardware debouncer circuit shall be considered on the EXT\_Trigger line.**

By default, the hardware trigger is **rising edge** activated, refer to below exposure timing:

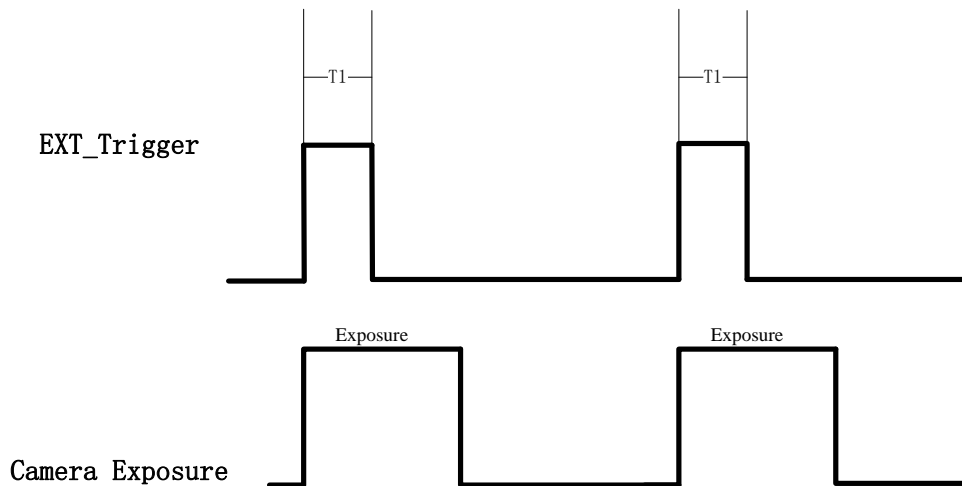

The requirement to T1 should be from 100us to 2ms.

### Exposure\_timing Pin Description

This pin is an output indicates the whole exposure period of the camera. The internal circuit of this pin with a pull-up resistor  $430\ \Omega$ . The pull up voltage is 5V. At low level, the pull-down resistor is  $100\ \Omega$ .

By default, the polarity is low level activated, which means a low-level signal indicates the exposure period. Please refer to below figure:

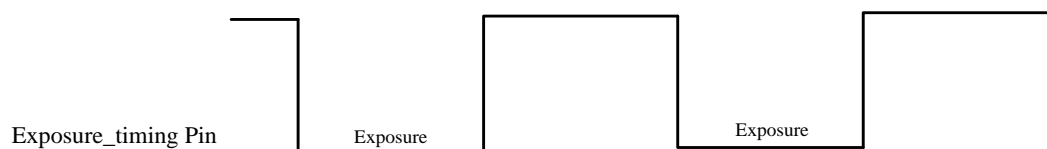

## 4.2 Type A USB2.0 Connector for DCAM550-U

DCAM550-U has the Type A 2.0 interface for data transmission and power supply.

By default the DCAM550-U works as USB slave at all time.

The USB port can work as USB host by customization from Vzense team, if you really need the USB OTG feature, please contact Vzense team for technical support.

## 4.3 RJ45 Ethernet Connector for DCAM550-P

DCAM550-P has the standard RJ45 interface for Ethernet transmission and PoE+ power supply;



---

## 4.4 LED indication

An LED at the back side of the camera indicates the camera status.  
The LED animation table is shown as below:

### DCAM550-U

Waiting for USB enumeration, GREEN LED blinking:

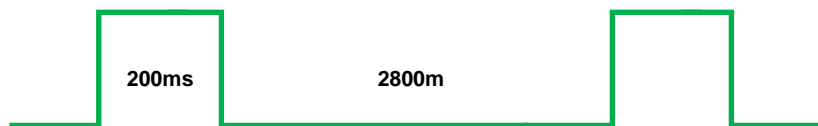

USB Connected without DC IN, GREEN LED constantly on:



USB Connected with DC IN, RED LED constantly on:



Firmware Upgrade, WHITE LED is on until firmware upgrade finished



ToF driver Upgrade, GREEN LED blinking

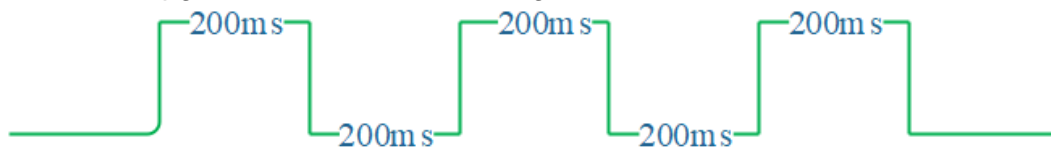

### DCAM550-P

Ethernet Broadcast, no connection established, BLUE LED blinking repeatedly



---

Ethernet connection established, BLUE LED constantly on



IP RESET, Press the IP RESET button for 5 seconds, PURPLE LED is on for 5 seconds and blink twice then the product reset itself.



Firmware Upgrade, WHITE LED is on until firmware upgrade finished



ToF driver Upgrade, GREEN LED blinking repeatedly

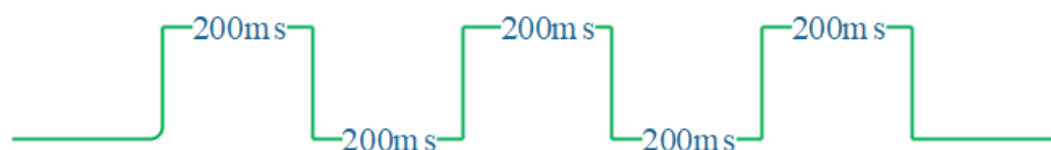

## 4.5 IP Reset Button for DCAM550-P

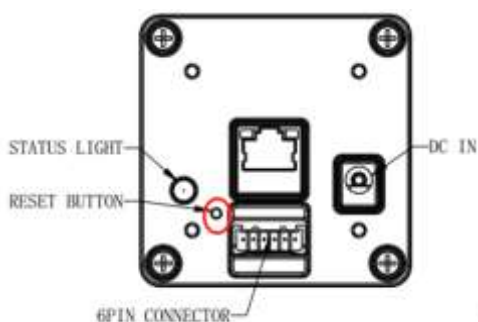

A hidden button hole is for IP reset, a pin shall be used to press the button. While the camera is powered on, long pressing the button for 10 seconds until the LED is off. Then the IP is reset as 192.168.1.101.

---

# 5 Principle of Time of Flight

## 5.1 Vzense ToF Principle

Vzense DCAM710 product principle is based on range-gated imaging ToF solution, and the sensor inside is based on Panasonic CCD sensor MN34906.

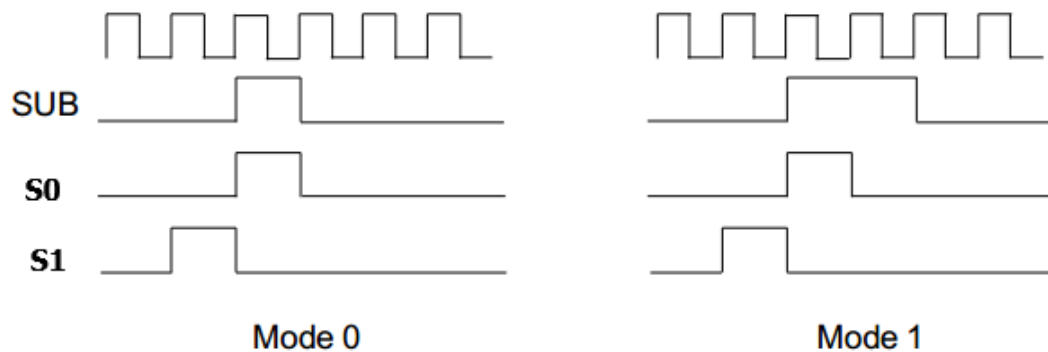

Fig. 9

◆ **Mode #0:**

- 1T,
- Best LD pulse number,
- good for distance from 10cm to 3.3m

$$Z = \frac{S_1}{S_0 + S_1}$$

Because the ToF distance measurement relies on the reflection of light sent out by the camera, any additional light, e.g. artificial light sources or sunlight, may influence the measurement results.

A strong ambient light may affect the accuracy and precision of the depth data, the Zense DCAM 710 is suggested to in user below 50K LUX ambient light.

## 5.2 Multipath Propagation

Based on the principle of ToF, Multipath effect may happen when the light reflected more one once. Any light that has been reflected several times, by other objects in the camera's field of view or the environment can cause deviation to the measurement result.

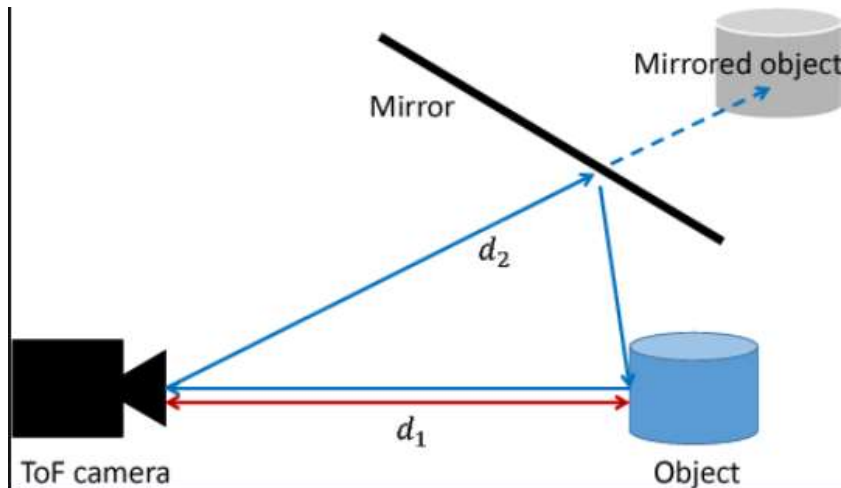

To eliminate the multipath effect, you should:

1. Keep the camera working environment as clean as possible;
2. Avoid the camera be placed at concave forms environment, like corners of a room or inside of a narrow space;
3. Highly-reflective object shall be removed far away from the measurement target;

### 5.3 Reflectivity of the Target

Please note that different reflectivity of the target may cause measurement result deviation, objects which have 20% to 80% reflectivity to 850nm or 940nm infrared light have the best result.

### 5.4 Scattering Effect

Scattering light effect is a noise factor to ToF products, it is caused by multiple reflection inside the lens of camera or the cover of camera.

To eliminate the scattering light effect, you should:

1. Keep the cover glass of the camera clean;
2. Do NOT place any other cover glass in front of the camera;
3. Keep the camera working environment as clean as possible;

---

# 6 Installation

## 6.1 Hardware Installation

You have read and understood the warnings listed under "Precautions" on Chapter 2; To achieve reliable distance measurements, please follow below tips:

- Better not using the camera in strong sunlight. If have to, keep the ambient light below 50k Lux.
- Do NOT place any objects in the scene that are not part of your intended target, especially mirrors or other shiny surfaces/objects.
- Maintain a stable housing temperature during operation.
- Take measures to provide cooling to camera
- Mount the camera robustly.
- All accessories are ready

### 6.1.1 USB2.0 Mode Installation (DCAM550-U Only)

In this mode, the camera transmits the required data to host by USB2.0 interface. For the application of near distance, the USB2.0 host can supply power to camera, for the application of long distance which needs more power consumption, the multiple functional cable (VZENSE-MFP-6P-B) shall be in use.

The steps are as below:

1. Mount the camera in an appropriate fixture, e.g. a camera bracket;
2. Plug the male end of the USB2.0 type A cable (VZENSE-USB-TYPEA-CABLE) into the type A female jack at the back of the camera, and plug the other type A male end into the USB port of your host processor;
3. Connect the adaptor to power source for long range usage;
4. Insert the cable (VZENSE-MFP-6P-B) if you need;

A Vzense DCAM550U device will be shown in the USB device list.

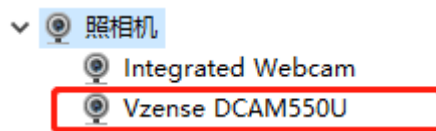

### 6.1.2 USB2.0 External Power Installation (DCAM550-U Only)

If you need stronger power in your application, besides the additional power supplied to the MFP port via VZENSE-MFP-6P-B cable mentioned above, we also provide another option, which using an external powered USB HUB. You shall connect the system as below figure:

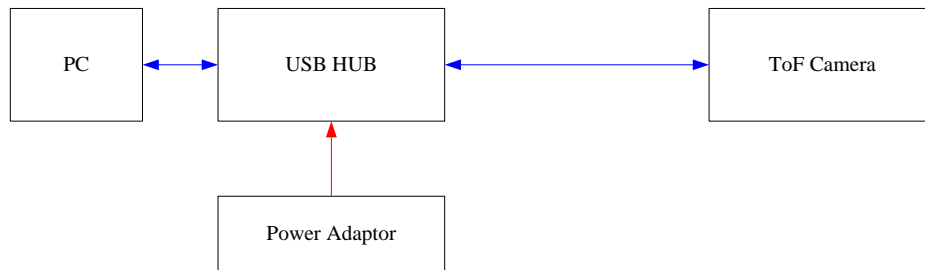

You can contact the Vzense team ([info@vzense.com](mailto:info@vzense.com)) for the external powered USB HUB.

### 6.1.3 100M Ethernet Installation (DCAM550-P Only)

In this mode, the camera transmits the required data to host by Ethernet cable, so the power adaptor shall be used.

The steps are as below:

1. Mount the camera in an appropriate fixture, e.g. a camera bracket;
2. Connect the DCAM550-P ToF camera to the host processor with the Ethernet cable(VZENSE-LAN-CAT5e-CABLE), the standard RJ45 socket locates at the back of the DCAM550-P ToF camera;
3. Insert the DC connector of the power supply adaptor into the 12V DC Jack at the back of the camera;
4. Connect the adaptor to power source;
5. Please do set the IP address of the camera and host PC in the same segment;
6. The default IP address of DCAM550-P is 192.168.1.101, you can change the IP address by the VzenseConfigTool;

China: <https://gitee.com/Vzense/VzenseConfigTool>

Oversea: <https://github.com/Vzense/VzenseConfigTool>

Please do read the document before reconfigure the camera:

REALMLC.md	Update REALMLC.md	11 months ago
ReleaseNotes.txt	Update Ver1.0.10	2 months ago
VzenseConfigTool.exe	Update Ver1.0.10	2 months ago
VzenseConfigTool使用说明.pdf	update doc	10 months ago
Vzense_ConfigTool_User_Guide.pdf	add user guide	8 months ago
msvcp140.dll	first edition release	11 months ago
vc2015_redist.x86.exe	Update Ver1.0.9	4 months ago
version	Update Ver1.0.10	2 months ago
vzense_api.dll	Update Ver1.0.9	4 months ago

---

## 6.1.4 POE Mode Installation

### What is POE (Power Over Ethernet)

Power over Ethernet (POE) is a technology that lets network cables carry electrical power.

For example, a digital security camera normally requires two connections to be made when it is installed:

A network connection, in order to be able to communicate with video recording and display equipment.

A power connection, to deliver the electrical power the camera needs to operate.

However, if the camera is POE-enabled, only the network connection needs to be made, as it will receive its electrical power from this cable as well.

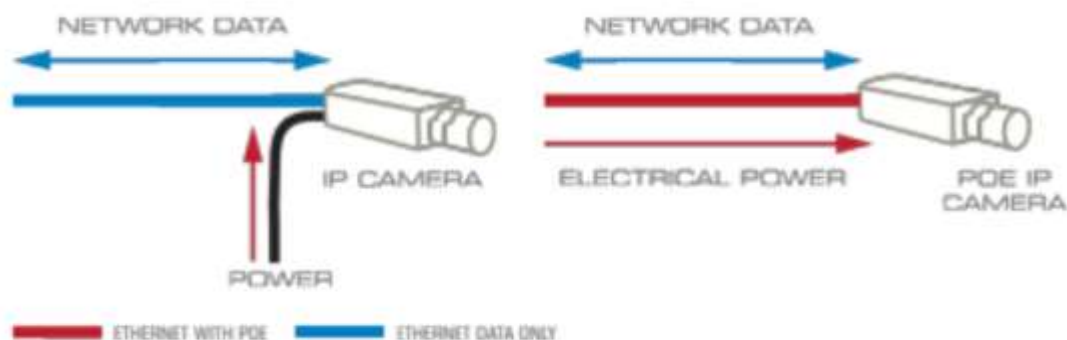

### Why Use PoE?

Specifying Power over Ethernet brings many advantages to an installation:

**Time and cost savings** - by reducing the time and expense of having electrical power cabling installed. Network cables do not require a qualified electrician to fit them, and can be located anywhere.

**Flexibility** - without being tethered to an electrical outlet, devices such as IP cameras and wireless access points can be located wherever they are needed most, and repositioned easily if required.

**Safety** - POE delivery is intelligent, and designed to protect network equipment from overload, underpowering, or incorrect installation.

**Reliability** - POE power comes from a central and universally compatible source, rather than a collection of distributed wall adapters. It can be backed-up by an uninterruptible power supply, or controlled to easily disable or reset devices.

**Scalability** - having power available on the network means that installation and

---

distribution of network connections is simple and effective

## How to Upgrade to POE

Adding POE to your network is straightforward, and there are two routes you can choose:

A **POE switch** is a network switch that has Power over Ethernet injection built-in. Simply connect other network devices to the switch as normal, and the switch will detect whether they are POE-compatible and enable power automatically. POE switches are available to suit all applications, from low-cost unmanaged [edge switches](#) with a few ports, up to complex multi-port rack-mounted units with sophisticated management.

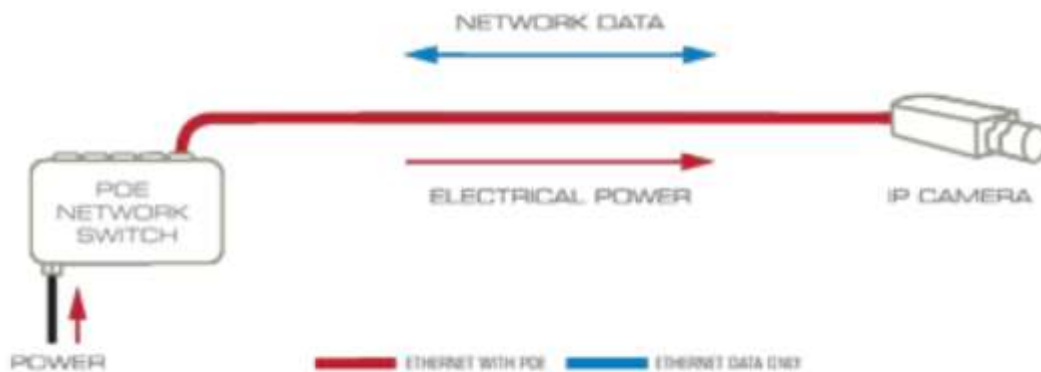

A **midspan (or POE injector)** is used to add POE capability to regular non-POE network links. Midspans can be used to upgrade existing LAN installations to POE, and provide a versatile solution where fewer POE ports are required. Upgrading each network connection to POE is as simple as patching it through the midspan, and as with POE switches, power injection is controlled and automatic.

Midspans are available as multi-port rack-mounted units or low-cost [single-port injectors](#).

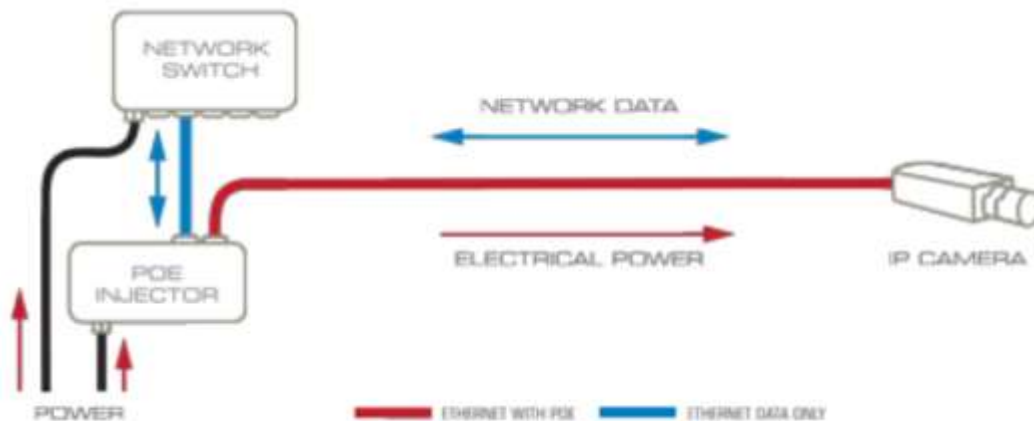

For Vzense DCAM550 camera, the POE Switch or POE injector needs to support



---

IEEE 802.3at-2009 standard also known as PoE+, which can provide up to 25.5W, or IEEE 802.3bt-2018 standard also known as PoE++, which can provide up to 60W. Otherwise the product may not work well at long range mode.

We can provide optional PoE switch or PoE injector to our customers, please try to contact the sales for the quotation and more information.

#### **Steps to Setup PoE Mode**

As mentioned above, a PoE switch or PoE injector shall be in use to setup the PoE; The steps are as below:

1. Mount the camera in an appropriate fixture, e.g. a camera bracket;
2. Plug one end of the Ethernet cable into the RK45 socket at the back of the camera, and plug the RJ45 end into the Ethernet port of your PoE switch or PoE injector;
3. Connect the PoE switch or PoE injector to your host processor by Ethernet cable;
4. Connect the PoE switch or PoE injector to power source;

### **6.1.5 Standalone Mode Installation**

This mode is for advanced users who require customization to the software and application, the applications can run on the processor inside the camera, and output the result data by either RS485 or EXT\_OUTPUT pin. NRE fee shall be charged if you need Vzense team to do software or application customization.

In this mode, the cable (VZENSE-MFP-6P-B) shall be used in this mode.

## 6.2 Software Installation

### 6.2.1 How to get

Download or clone SDK project from our GitHub /Gitee:

China: <https://gitee.com/Vzense>

Oversea: <https://github.com/Vzense>

Please chose the suitable version based on the product and system. Windows SDK, Linux SDK have different project repository.



### 6.2.2 Graphic Tool on windows

Vense uTool is a graphic tool on windows for the all Vzense ToF products.

Download or clone uTool evaluation tool from our GitHub /Gitee:

China: <https://gitee.com/Vzense/UTool>

Oversea: <https://github.com/Vzense/UTool>

Please do read the Vzense\_UTool\_User\_guide.pdf before using.

Qt5Widgets.dll	2020/4/7 11:55	应用程序扩展	4,386 KB
UTool.ini	2021/1/13 10:36	配置设置	1 KB
version	2021/1/29 20:59	文件	1 KB
vzense_api.dll	2021/1/29 20:40	应用程序扩展	1,166 KB
Vzense_UTool_User_Guide.pdf	2020/8/25 14:20	Foxit Reader PD...	1,739 KB
VzenseUTool.exe	2021/2/1 9:16	应用程序	1,792 KB
VzenseUTool用户手册.pdf	2020/8/25 13:51	Foxit Reader PD...	1,840 KB

## 6.2.3 Frameviewer

Frameviewer is an opensource application in SDK project that can guide user how to call the SDK APIs. It has a pre-build version app in Tools folder, the source code is in Samples folder. See the document for the details.

Bin	V3.0.0.8	10 days ago
Document	V3.0.0.8	7 days ago
include	V3.0.0.8	10 days ago
Lib	V3.0.0.8	10 days ago
Samples	V3.0.0.8	10 days ago
Tools	V3.0.0.8	10 days ago
README.md	V3.0.0.8	7 days ago
ReleaseNotes.txt	V3.0.0.8	10 days ago

## 6.3 Firmware Upgrade

Download the VzenseUpgradeTool from below link:

China: <https://gitee.com/Vzense/VzenseUpgradeTool>

Oversea: <https://github.com/Vzense/VzenseUpgradeTool>

Please read the Vzense\_UpgradeTool\_User\_Guide.pdf before upgrading firmware.

platforms	2021/7/28 12:38	文件夹	
Upgrade	2021/7/28 12:38	文件夹	
ImgPreProcess.dll	2021/7/16 9:30	应用程序扩展	10,632 KB
msvcp140.dll	2021/7/16 9:30	应用程序扩展	440 KB
Qt5Core.dll	2021/7/16 9:30	应用程序扩展	4,646 KB
Qt5Gui.dll	2021/7/16 9:30	应用程序扩展	4,843 KB
Qt5Widgets.dll	2021/7/16 9:30	应用程序扩展	4,348 KB
README.md	2021/7/16 9:30	MD 文件	1 KB
ReleaseNotes.txt	2021/7/16 9:30	文本文档	1 KB
version	2021/7/16 9:30	文件	1 KB
vzense_api.dll	2021/7/16 9:30	应用程序扩展	1,166 KB
Vzense_UpgradeTool_User_Guide.pdf	2021/7/16 9:30	Foxit Reader PD...	713 KB
VzenseUpgradeTool.exe	2021/7/16 9:30	应用程序	195 KB

---

## 6.4 Product State Machine

### DCAM550-U

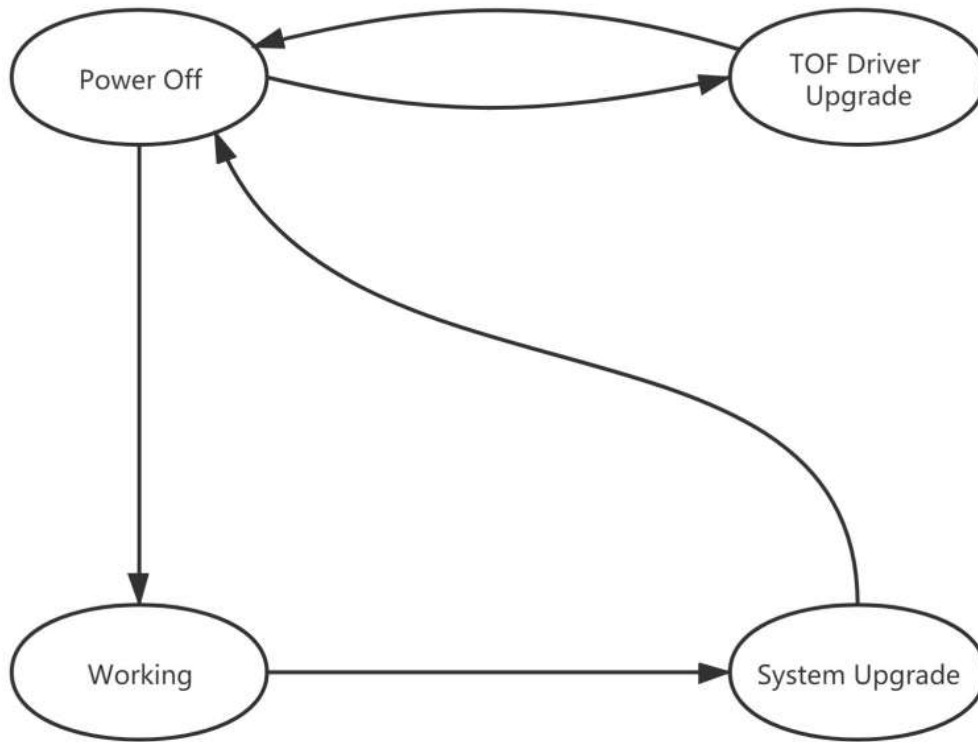

- Power Off: product do not have any power
- Working: product is ready for connect and frame out
- TOF Driver Upgrade: product is in upgrade of TOF driver
- System Upgrade: product is in upgrade of firmware

---

## DCAM550-P

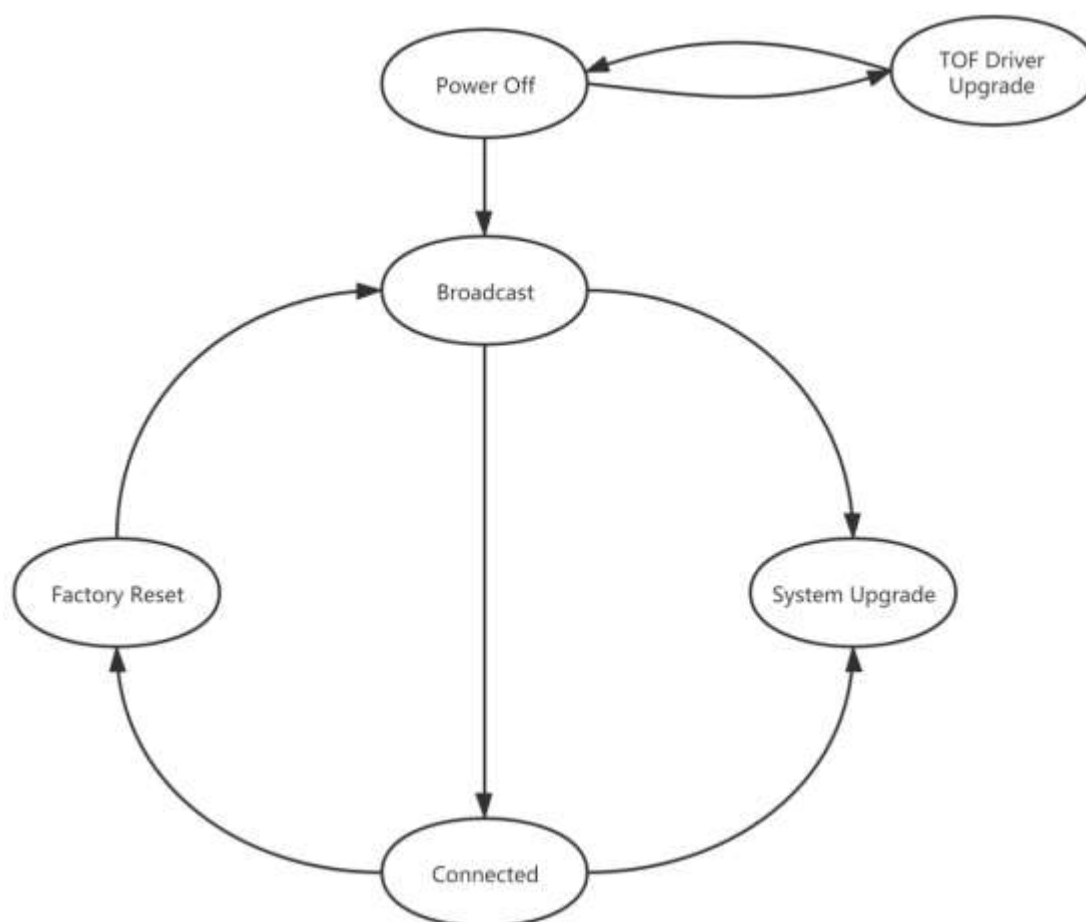

- Power Off: product do not have any power
- Broadcast: broadcast IP address, socket have not connected
- Connected: socket is connected, product can transfer image and answer host command
- Factory Reset: resume all data to factory setting
- TOF Driver Upgrade: product is in upgrading of TOF driver
- System Upgrade: product is in upgrading of firmware

## 6.5 Software Command Set

DCAM550 support different work mode like depth\_30, IR\_30, depth&IR\_30.

Three default range: range0(0.35m~1.5m), range1(0.35m~1.5m), range2(0.8m~4.4m), range5(1.2m~6.0m).

User can use Frameviewer to try the different command or can use the APIs to control the camera. The details please reference the SDK documents.

## 6.6 USB Connection

DCAM550 use UVC profile to transfer image and control command.

---

# 7 Features

## 7.1 Slave Trigger Mode

At slave trigger mode, the DCAM550 product outputs image only at every trigger signal happens.

Please refer to **4.1 6 Pin Connector** for the requirement to the hardware trigger signal;

Two ways can set the DCAM550 product at slave trigger mode:

- 1) Call API `Ps2_SetSlaveModeEnabled(PsDeviceHandle device, uint32_t sessionIndex, bool bEnabled)`, before `Ps2_StartStream()`;  
This way requires calling the API every power cycle.
- 2) Use Vzense Cofig Tool to set the the default mode as slave mode;  
This way can hardcode the product as slave mode by default.

WorkMode_list	[master,slave]
WorkMode	master <b>Type in master or slave</b>

Configure the product at either master or slave mode; You shall type in one workmode in the list, case sensitive.

The slave trigger mode can be used to implement multiple products synchronization, one works as master, the other works as slave.

Please refer to `Multiple_ToF_Products_Synchronization_Application_Note.pdf` for more information.

## 7.2 Range Customization

By default, there are 4 different range modes calibrated for DCAM550, please see below table for more information:

Range number	Distance range
Range 0	0.35m~1.5m
Range 1	0.5m~2.8m
Range 2	0.8m~4.4m
Range 5	1.2m~6.0m

Please do NOT use uncalibrated modes, the measurement data will not be guaranteed.

If you need other range mode requirement, you can ask Vzense team to do range customization, reasonable NRE fee will be charged.

One range mode of the Vzense DCAM550 camera can fulfill furthest distance be at most 5 times to nearest distance. For example, if the near limitation is 0.4m, then the furthest distance in this mode can reach about 2m.

## 7.3 Wide Dynamic Range

As mentioned above, Most of the ToF based 3D sensing technology has range limitation to nearest and furthest distance, due to the sensor saturation of weak light strength to far objects. One range mode of the Vzense DCAM550 camera can fulfill furthest distance be at most 5 times to nearest distance. For example, if the near limitation is 0.4m, then the furthest distance in this mode can reach about 2m.

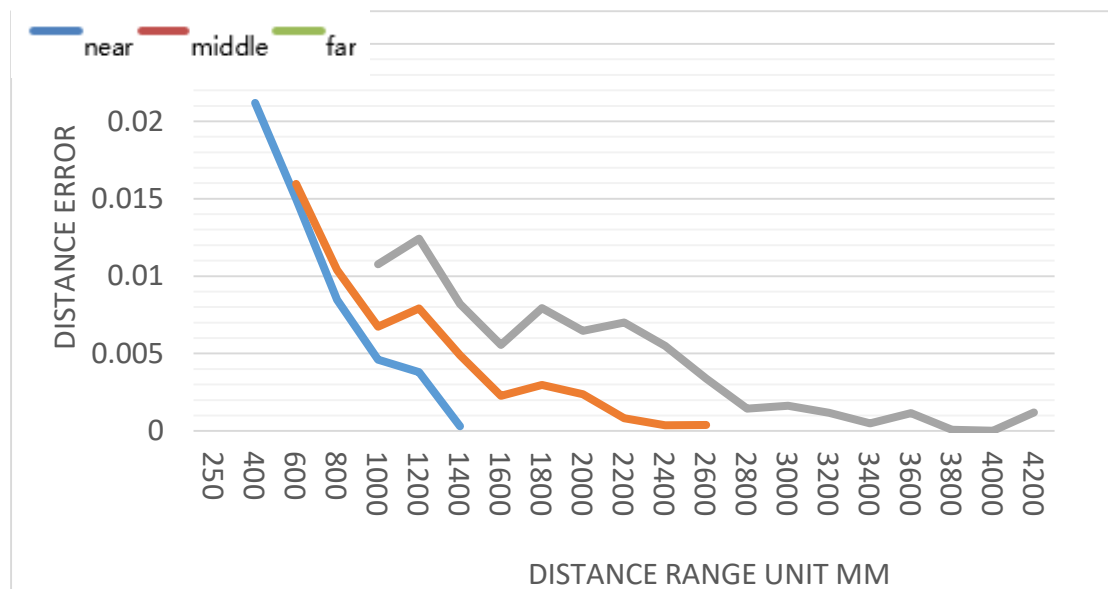

Wide dynamic range means that the camera can work at more than one range modes alternately, then the camera itself will combine the frames of all ranges into one depth frame, therefore can expand the range limitation from furthest distance to nearest distance.

However the frame rate will be reduced.

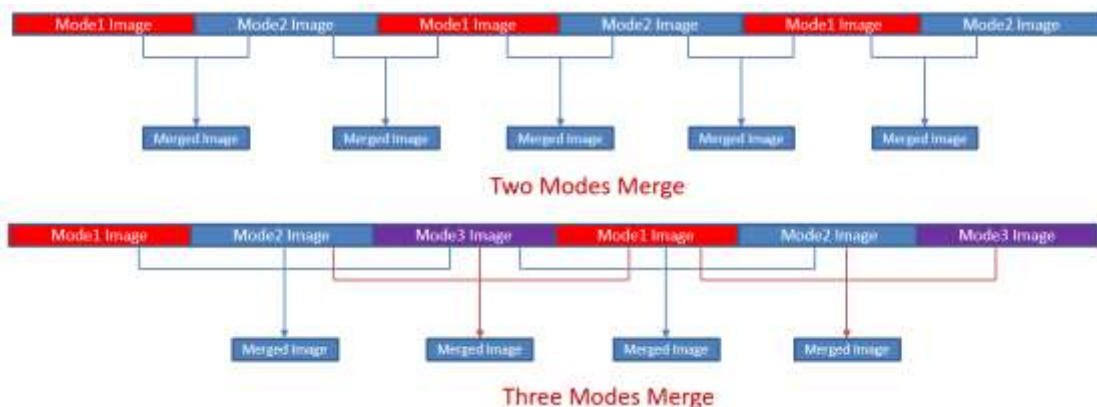

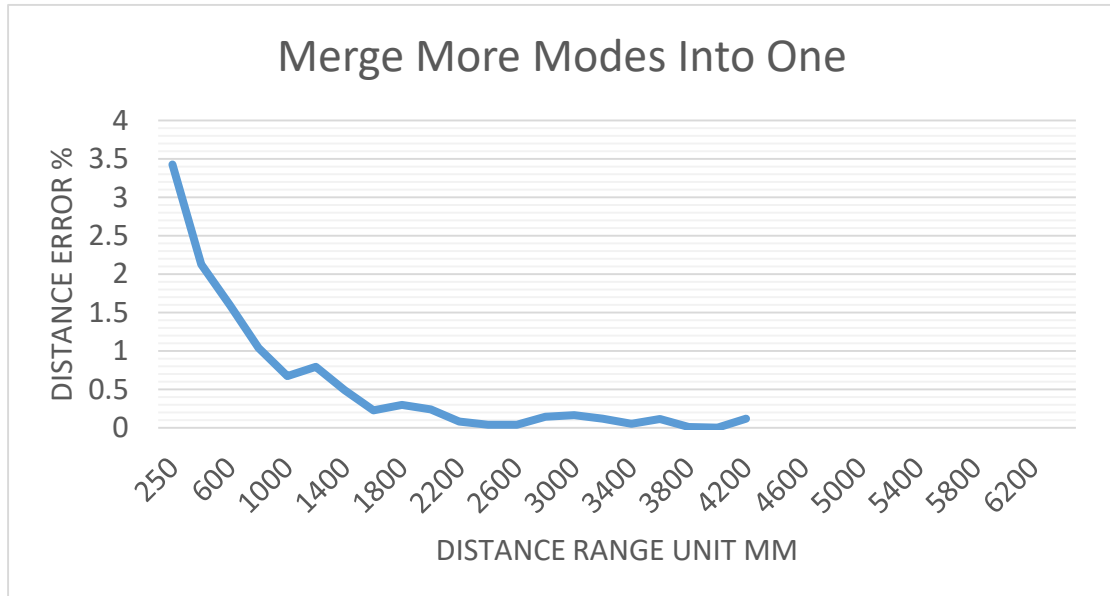

Please refer to Vzense\_WDR\_function\_application\_note.pdf for the WDR implementation steps.

## 7.4 Data Filtering

In the software SDK and Frameviewer, we implemented data filtering to improve the depth data performance.

The filtering algorithm includes:

- Median filtering;
- Gaussian filtering;
- Bilateral filtering;
- Timing filtering;
- Flying pixel removing;

## 7.5 IR Image

Besides the depth image, Vzense DCAM550 camera can also output a VGA resolution IR image. And the IR image is exactly timing synchronized with the depth image. Pixel to pixel mapping is also exactly aligned.



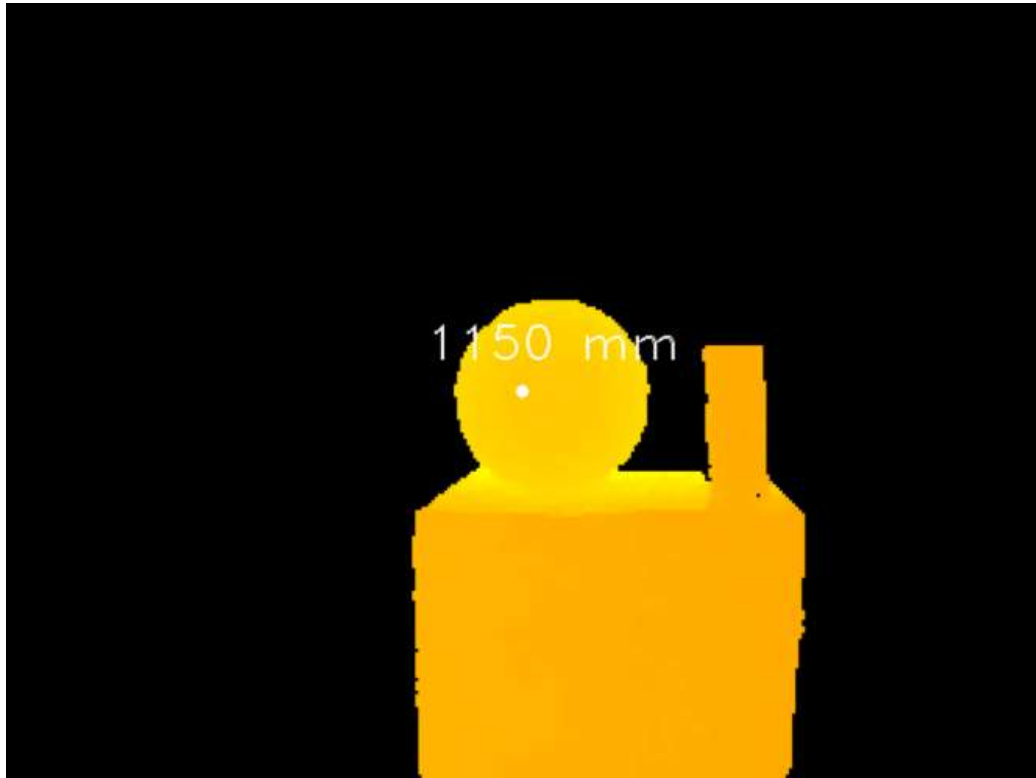

---

# 8 Camera Operation on Frameviewer

Please refer to 6.2.1 for the SDK downloading.

Function		Description
2D image show		depth image colorize
Camera hardware information show		like SN, version
Image store		
Mode Switch	Depth 30	depth image in 30fps
	IR 30	IR image in 30fps
	Depth&IR 30	both depth and ir in 30fps
	WDR	see the detail in below
Range Change	Range 0-7	different depth detect range
Exposure parameter modify	Pulse count	laser pulse parameter
	Gamma gain	IR image gamma gain
Filters switch		different image filters
IR_BG		the background light switch

## 8.1 Main screen

Frameviewer have some areas for different function, for example, image windows, command and information area.

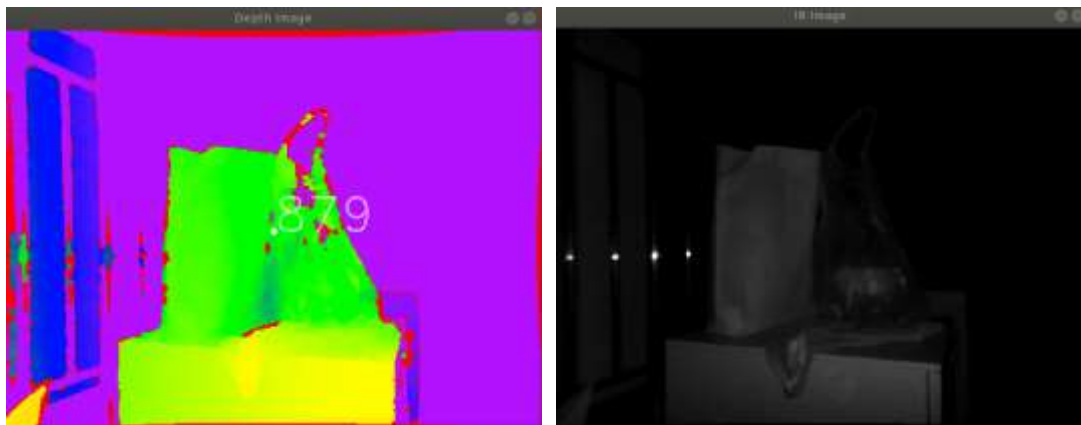

```

File Edit View Search Terminal Help
-----
Press following key to set corresponding feature:
0/1/2,...: Change depth range Near/Middle/Far,...
S/s: Enable or disable the Depth and RGB synchronize feature
P/p: Save point cloud data into PointCloud.txt in current directory
T/t: Change background filter threshold value
M/m: Change data mode: Input corresponding index in terminal:
      0: Output Depth and RGB in 30 fps
      1: Output IR and RGB in 30 fps
      2: Output Depth and IR in 30 fps
      3: Output Depth/IR frames alternatively in 15fps, and RGB in
30fps
      4: Output HDR Depth and RGB in 30 fps
R/r: Change the RGB resolution: Input corresponding index in terminal:
      0: 1920*1080
      1: 1280*720
      2: 640*480
      3: 640*360
Q/q: Enable or disable the mapped RGB in Depth space
L/l: Enable or disable the mapped Depth in RGB space
V/v: Enable or disable the HDR depth fusion feature
Esc: Program quit
-----

```

### 8.1.1 Image area

Image area is the area of showing depth image, IR image.

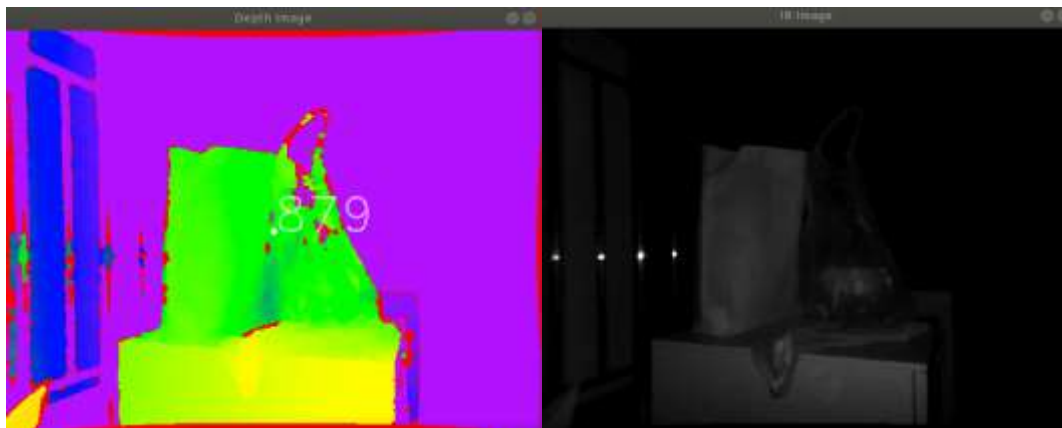

### 8.1.2 Command and information area

Frameviewer use CMD shell for camera control and information output. Like the image below: switch mode, change detect range, save 3D image and so on.

```

File Edit View Search Terminal Help
-----
Press following key to set corresponding feature:
0/1/2,...: Change depth range Near/Middle/Far,...
S/s: Enable or disable the Depth and RGB synchronize feature
P/p: Save point cloud data into PointCloud.txt in current directory
T/t: Change background filter threshold value
M/m: Change data mode: Input corresponding index in terminal:
      0: Output Depth and RGB in 30 fps
      1: Output IR and RGB in 30 fps
      2: Output Depth and IR in 30 fps
      3: Output Depth/IR frames alternatively in 15fps, and RGB in
30fps
      4: Output HDR Depth and RGB in 30 fps
R/r: Change the RGB resolution: Input corresponding index in terminal:
      0: 1920*1080
      1: 1280*720
      2: 640*480
      3: 640*360
Q/q: Enable or disable the mapped RGB in Depth space
L/l: Enable or disable the mapped Depth in RGB space
V/v: Enable or disable the HDR depth fusion feature
Esc: Program quit
-----

```

## 8.2 Connect devices

Frameviewer will auto-connect the device, and output the base information on the window.

```
Get device count: 1
Set Data Mode to PsDepthAndIR_30
Set Depth Range to Near
Get PsGetCameraParameters status: 0
Depth Camera Intinsic:
Fx: 462.147
Cx: 330.051
Fy: 461.97
Cy: 248.288
Depth Distortion Coefficient:
K1: 0.865453
K2: 0.912947
P1: 0.00318054
P2: -0.00251837
K3: -1.5716
K4: 0.464547
K5: 1.85229
K6: -1.96393
Get PsGetCameraExtrinsicParameters status: 0
Camera rotation:
0.999929 -0.00893352 -0.00789697 0.00891819 0.999958 -0.00197372 0.00791428 0.00
190315 0.999967
```

## 8.3 2D view

The display area can show different type image.



### 8.3.1 Depth Image

Depth image is convert to a rainbow image for real distance showing.

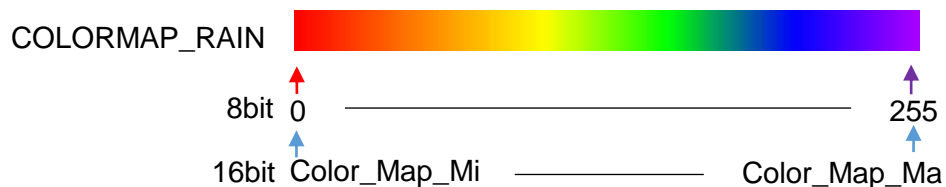

Depth Image with color map:



### 8.3.2 IR Image



## 8.4 3D image store

When the depth image is showing, input 's/S' to store the point cloud file. User can use CloudCompare to viewer the 3D image.

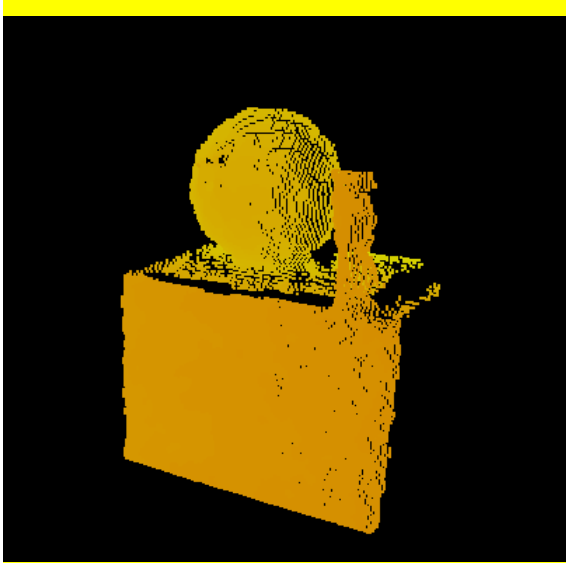

## 8.5 Camera Control

### 8.5.1 Mode switch

```
M/m: Change data mode: input corresponding index in terminal:
    0: Output Depth and RGB in 30 fps
    1: Output IR and RGB in 30 fps
    2: Output Depth and IR in 30 fps
    3: Output Depth/IR frames alternatively in 15fps, and RGB in
```

DCAM550 can support Depth\_30, IR\_30, Depth&IR\_30.

Depth\_30: depth image only in 30 fps.

IR\_30: IR image only in 30 fps.

Depth&IR\_30: depth and IR image all in 30 fps.

### 8.5.2 Range change

```
Press following key to set corresponding feature:
0/1/2...: Change depth range Near/Middle/Far...
```

By default, DCAM550 product has 4 different range modes calibrated, please see below table for more information:

Range number	Distance range
Range 0	0.35m~1.5m
Range 1	0.5m~2.8m
Range 2	0.8m~4.4m
Range 5	1.2m~6.0m

Please do NOT use uncalibrated modes, the measurement data will not be guaranteed.

If you need other range mode requirement, you can ask Vzense team to do range customization, reasonable NRE fee will be charged.

## 8.6 WDR

WDR mode can merge the multi-range image to extend the detect range. For example, if you want to get the distance from 0.35m to 4.4m, only one range mode can't cover the whole distance. Use range 0 and 2 WDR can match this requirement.

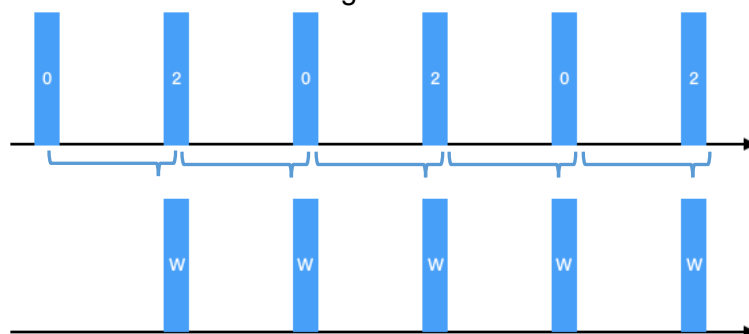

- Configure the WDR mode:

```
#WDR
t1_totalRange=2
t1_range1=0
t1_range1Count=1
t1_range2=2
t1_range2Count=1
t1_range3=0
t1_range3Count=1

t1_threshold1=1250
t1_threshold2=2500
```

If you have some particular requirement and want to use WDR mode, you can contract with Vzense FAE first.

- Change mode to WDR mode:

```
M/m: Change data mode: input corresponding index in terminal:
0: Output Depth and RGB in 30 fps
1: Output IR and RGB in 30 fps
2: Output Depth and IR in 30 fps
3: Output Depth/IR frames alternatively in 15fps, and RGB in
30fps
4: Output WDR_Depth and RGB in 30 fps
```

---

Depth image in range 0:

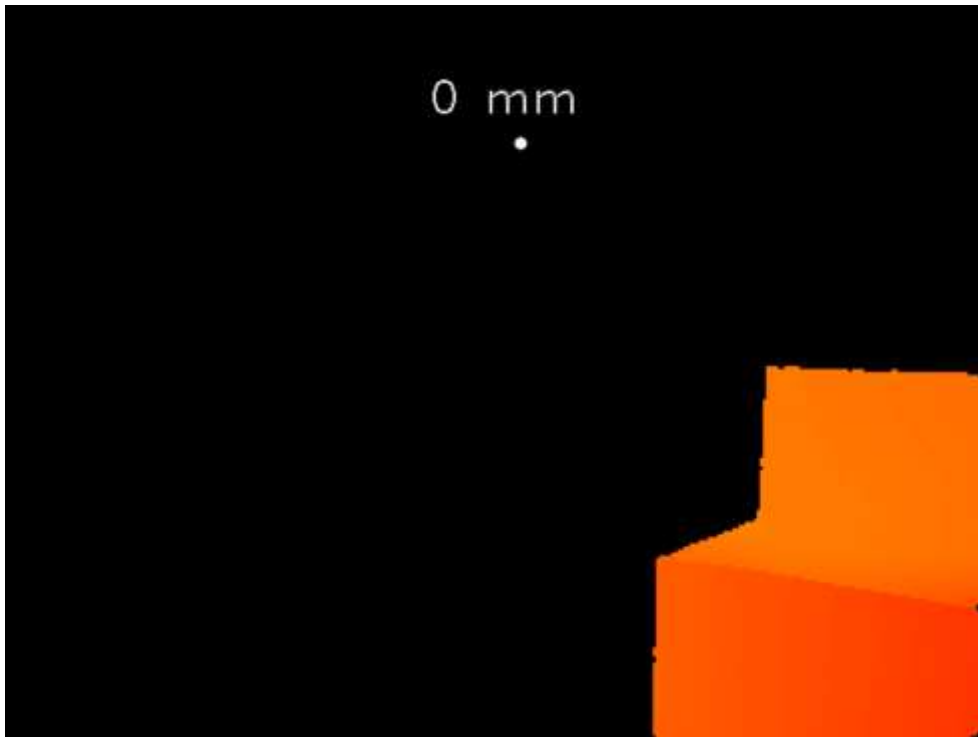

Depth image in range 2:

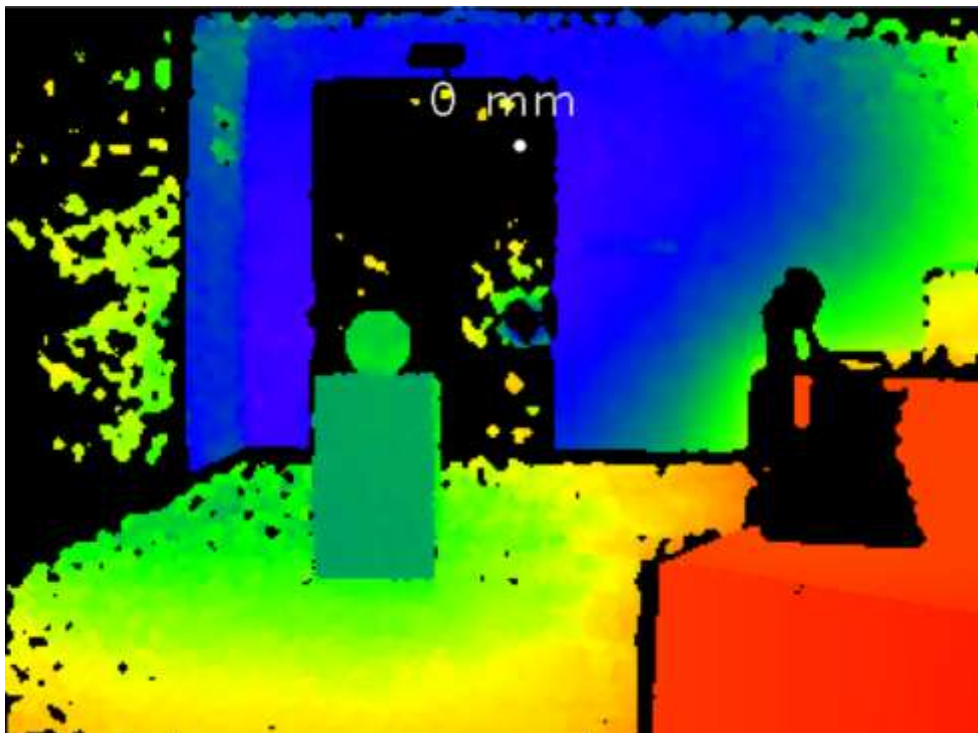



---

Merged depth image in WDR mode

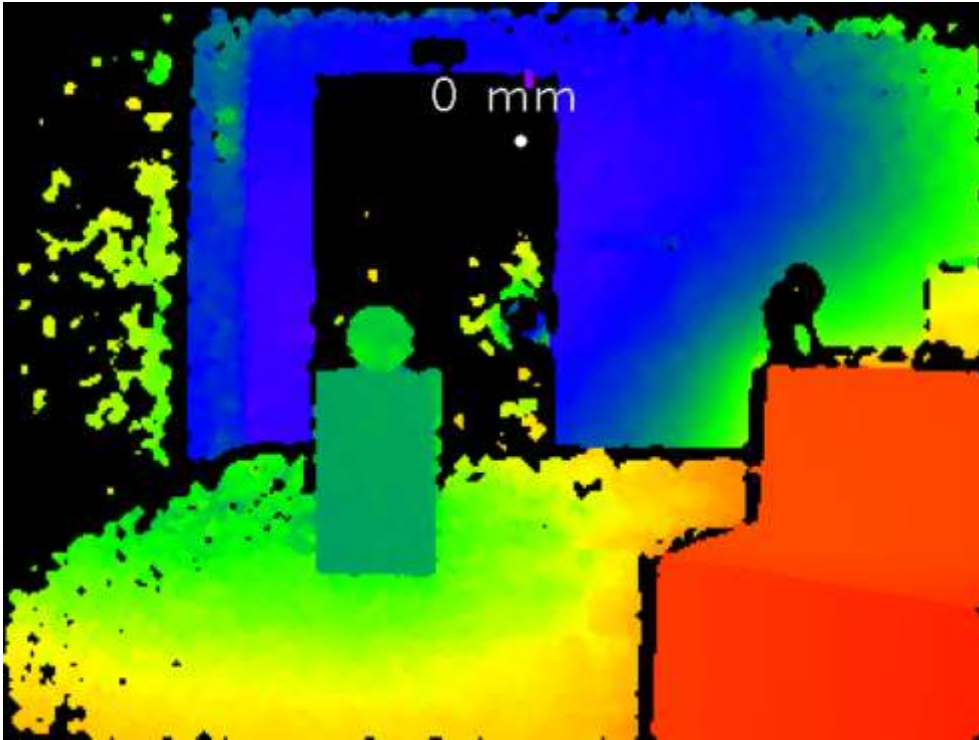

---

## 9 DCAM550 Accessories and Package

In package item list:

### DCAM550-U

Item	Part number	Description	Quantity
1	DCAM550-U	Vzense DCAM550-U Depth Camera Module	1
2	VZENSE-USB-TYPEA-CABLE	Dual Head Type A Lockable Cable	1
3	VZENSE-DC-12V3A-A	Power adaptor, DC 12V,3A	1
4	User Guide	User guide	1

### DCAM550-P

Item	Part number	Description	Quantity
1	DCAM550-P	Vzense DCAM550-P Depth Camera Module	1
2	VZENSE-LAN-CAT5e-CABLE	RJ45, 100M Ethernet Cable	1
3	VZENSE-DC-12V3A-A	Power adaptor, DC 12V,3A	1
4	User Guide	User guide	1

You can ask Vzense to do customization to the cable for any reason, for example extending the cable length.

Please do NOT use the accessories from other parts except Vzense Company, otherwise warranty will void.

Optional item list:

Item	Component	Description	Quantity
1	VZENSE-MFP-6P-B	Multiple Functional Cable(RS485, EXT IO)	1
3	H3C EWPAM2NPOE	802.3at PoE Injector	1

Optional items need customer to pay for.

---

## **10 Customization Service**

Vzense team has rich experience in ToF product design and delivery, we welcome customer to send customization requirement besides the standard module. Reasonable NRE fee shall be charged depends on the requirement.

### **Appendix**

**ROHS Declaration**

**Eye Safety Declaration**

**Reliability Declaration**

**Revision History**