

Main Product Characteristics

$V_{(BR)DSS}$	-30V
$R_{DS(ON)}$	75m Ω
I_D	-3.8A

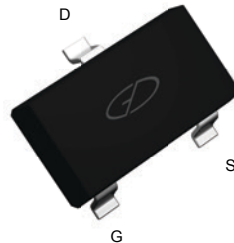

SOT-23

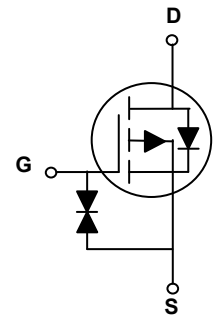

Schematic Diagram

Features and Benefits

- Advanced MOSFET process technology
- Ideal for high efficiency switched mode power supplies
- Low on-resistance with low gate charge
- Fast switching and reverse body recovery



Description

The SSF8309S utilizes the latest techniques to achieve high cell density and low on-resistance. These features make this device extremely efficient and reliable for use in high efficiency switch mode power supply and a wide variety of other applications.

Absolute Maximum Ratings ($T_C=25^\circ\text{C}$ unless otherwise specified)

Parameter	Symbol	Value	Unit
Drain-Source Voltage	V_{DS}	-30	V
Gate-Source Voltage	V_{GS}	± 25	V
Drain Current – Continuous ($T_A=25^\circ\text{C}$)	I_D	-3.8	A
Drain Current – Continuous ($T_A=70^\circ\text{C}$)		-3.0	A
Drain Current – Pulsed ¹	I_{DM}	-15.2	A
Power Dissipation ($T_A=25^\circ\text{C}$)	P_D	1.56	W
Power Dissipation – Derate above 25 $^\circ\text{C}$		0.012	W/ $^\circ\text{C}$
Storage Temperature Range	T_{STG}	-55 to+150	$^\circ\text{C}$
Operating Junction Temperature Range	T_J	-55 to+150	$^\circ\text{C}$

Thermal Characteristics

Parameter	Symbol	Typ.	Max.	Unit
Thermal Resistance Junction to Ambient	$R_{\theta JA}$	---	80	$^\circ\text{C}/\text{W}$

Electrical Characteristics ($T_J=25^{\circ}\text{C}$ unless otherwise specified)

Parameter	Symbol	Conditions	Min.	Typ.	Max.	Unit
Off Characteristics						
Drain-Source Breakdown Voltage	BV_{DSS}	$V_{GS}=0V, I_D=-250\mu A$	-30	---	---	V
BV_{DSS} Temperature Coefficient	$\Delta BV_{DSS}/\Delta T_J$	Reference to $25^{\circ}\text{C}, I_D=-1\text{mA}$	---	-0.03	---	$\text{V}/^{\circ}\text{C}$
Drain-Source Leakage Current	I_{DSS}	$V_{DS}=-30V, V_{GS}=0V, T_J=25^{\circ}\text{C}$	---	---	-1	μA
		$V_{DS}=-24V, V_{GS}=0V, T_J=125^{\circ}\text{C}$	---	---	-10	μA
Gate-Source Leakage Current	I_{GSS}	$V_{GS}=\pm 20V, V_{DS}=0V$	---	---	± 20	μA
On Characteristics						
Static Drain-Source On-Resistance	$R_{DS(ON)}$	$V_{GS}=-10V, I_D=-3A$	---	64	75	$\text{m}\Omega$
		$V_{GS}=-4.5V, I_D=-2A$	---	105	130	$\text{m}\Omega$
Gate Threshold Voltage	$V_{GS(th)}$	$V_{GS}=V_{DS}, I_D=-250\mu A$	-1.2	-1.6	-2.2	V
$V_{GS(th)}$ Temperature Coefficient	$\Delta V_{GS(th)}$		---	4	---	$\text{mV}/^{\circ}\text{C}$
Forward Transconductance	g_{fs}	$V_{DS}=-10V, I_D=-3A$	---	3.5	---	S
Dynamic and switching Characteristics						
Total Gate Charge ^{2, 3}	Q_g	$V_{DS}=-15V, V_{GS}=-4.5V, I_D=-3A$	---	4.2	6	nC
Gate-Source Charge ^{2, 3}	Q_{gs}		---	1.9	2.5	
Gate-Drain Charge ^{2, 3}	Q_{gd}		---	1.4	2	
Turn-On Delay Time ^{2, 3}	$T_{d(on)}$	$V_{DD}=-15V, V_{GS}=-10V, R_G=6\Omega, I_D=-1A$	---	2.8	5	nS
Rise Time ^{2, 3}	T_r		---	8.7	17	
Turn-Off Delay Time ^{2, 3}	$T_{d(off)}$		---	21.4	41	
Fall Time ^{2, 3}	T_f		---	5.7	11	
Input Capacitance	C_{iss}	$V_{DS}=-15V, V_{GS}=0V, F=1\text{MHz}$	---	460	665	pF
Output Capacitance	C_{oss}		---	45	65	
Reverse Transfer Capacitance	C_{rss}		---	30	45	
Drain-Source Diode Characteristics and Maximum Ratings						
Parameter	Symbol	Conditions	Min.	Typ.	Max.	Unit
Continuous Source Current	I_S	$V_G=V_D=0V, \text{Force Current}$	---	---	-3.8	A
Pulsed Source Current	I_{SM}		---	---	-15.2	A
Diode Forward Voltage	V_{SD}	$V_{GS}=0V, I_S=-1A, T_J=25^{\circ}\text{C}$	---	---	-1	V

Note:

1. Repetitive Rating: Pulsed width limited by maximum junction temperature.
2. The data tested by pulsed, pulse width $\leq 300\mu\text{s}$, duty cycle $\leq 2\%$.
3. Essentially independent of operating temperature.

Typical Electrical and Thermal Characteristic Curves

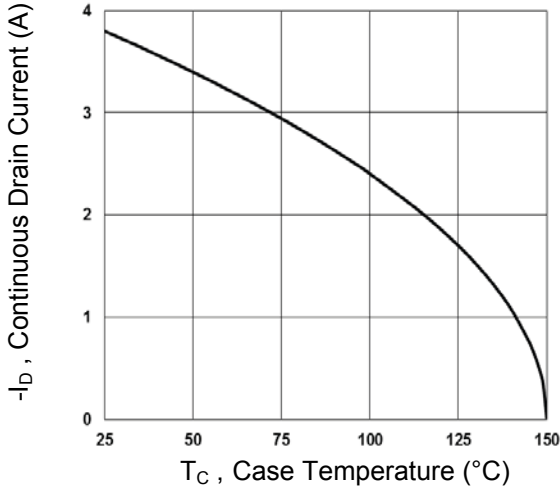

Fig.1 Continuous Drain Current vs. T_C

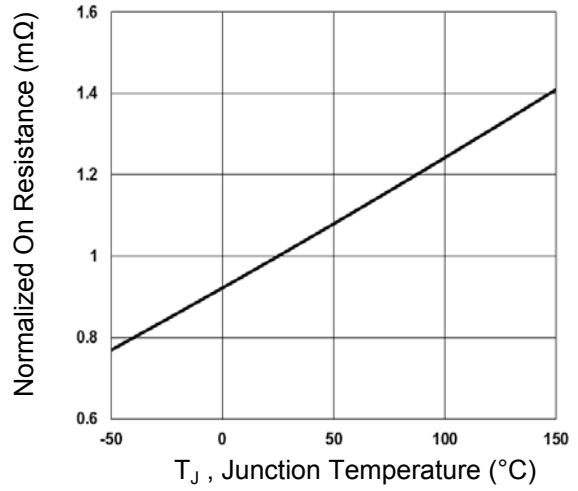

Fig.2 Normalized $R_{DS(ON)}$ vs. T_J

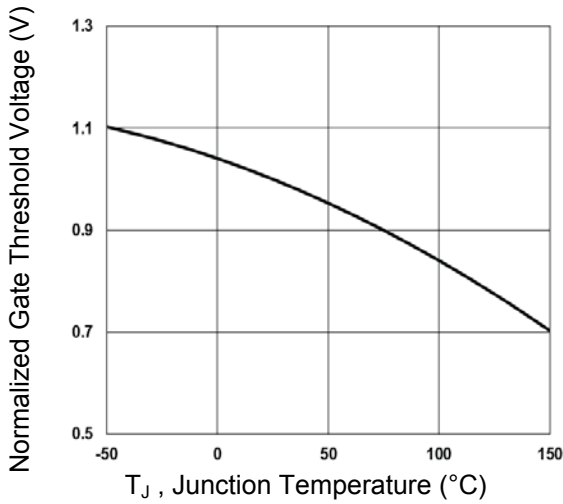

Fig.3 Normalized V_{th} vs. T_J

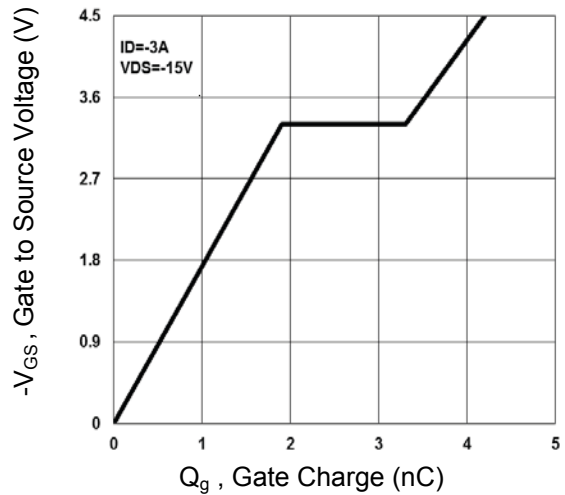

Fig.4 Gate Charge Waveform

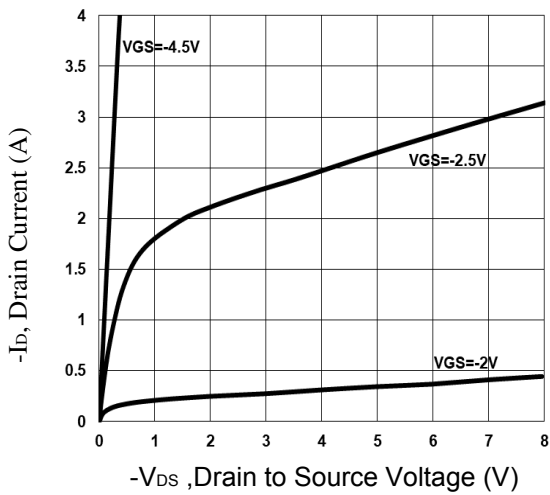

Fig.5 Typical Output Characteristics

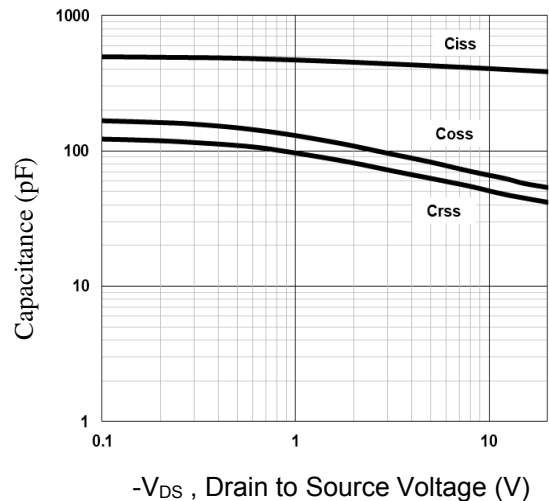

Fig.6 Capacitance Characteristics

Typical Electrical and Thermal Characteristic Curves

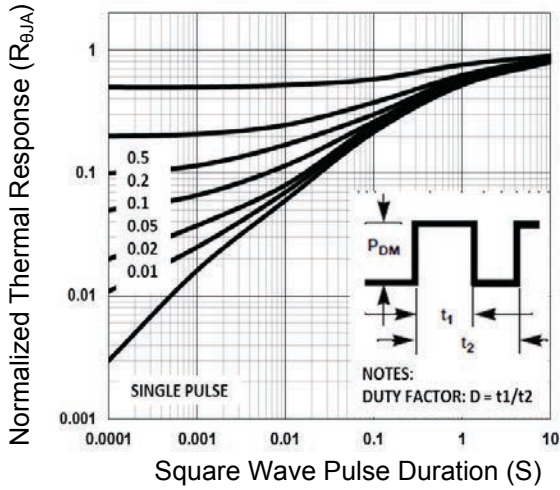

Fig.7 Normalized Transient Impedance

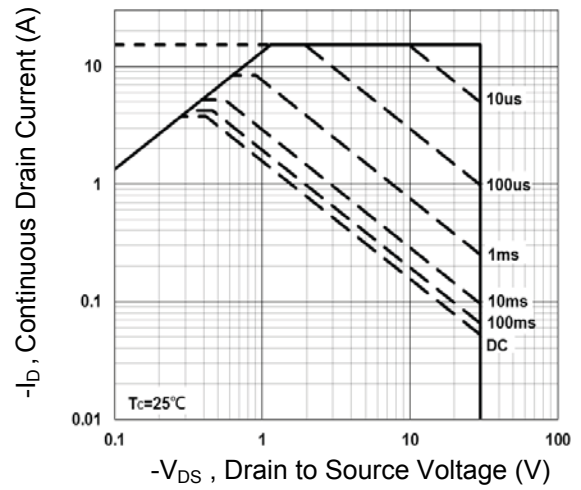

Fig.8 Maximum Safe Operation Area

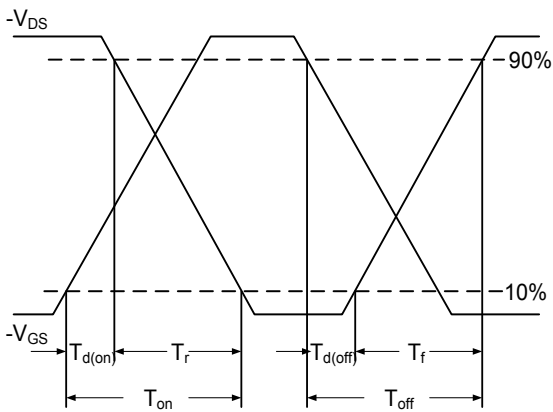

Fig.9 Switching Time Waveform

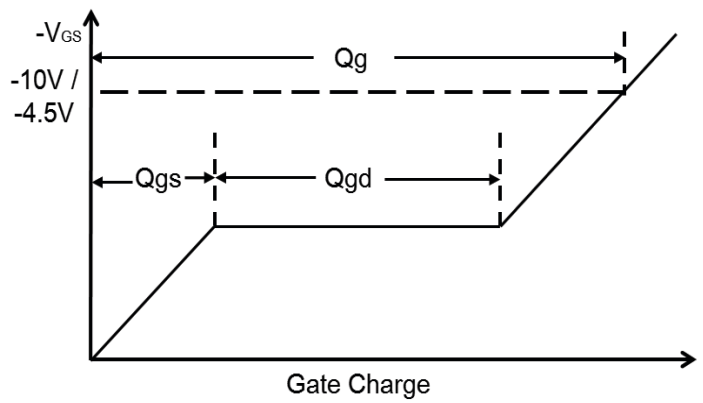
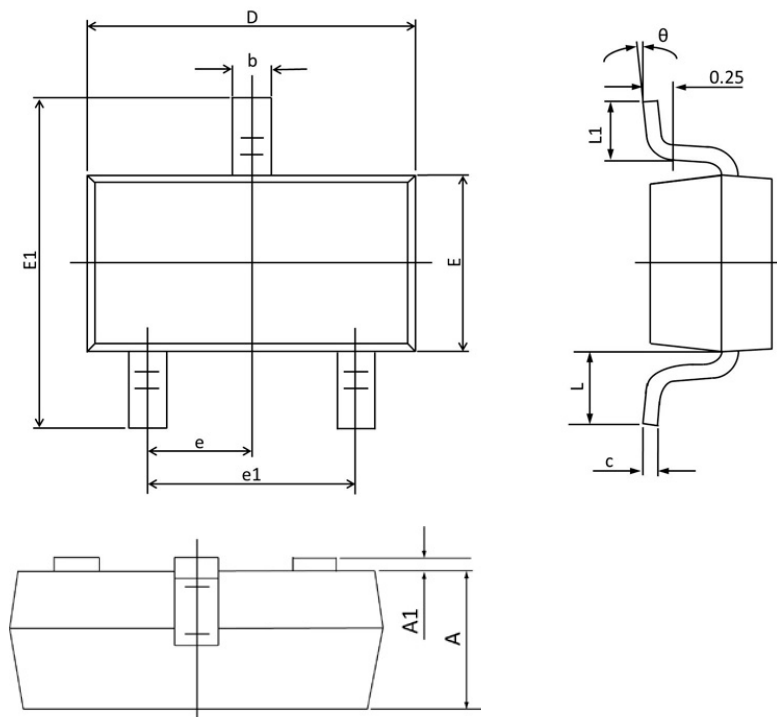

Fig.10 Gate Charge Waveform

Package Outline Dimensions

SOT-23



Symbol	Dimensions In Millimeters		Dimensions In Inches	
	Min	Max	Min	Max
A	0.900	1.000	0.035	0.039
A1	0.000	0.100	0.000	0.004
b	0.300	0.500	0.012	0.020
c	0.090	0.110	0.003	0.004
D	2.800	3.000	0.110	0.118
E	1.200	1.400	0.047	0.055
E1	2.250	2.550	0.089	0.100
e	0.950 TYP.		0.037 TYP.	
e1	1.800	2.000	0.071	0.079
L	0.550 REF.		0.022 REF.	
L1	0.300	0.500	0.012	0.020
θ	1°	7°	1°	7°