

10DAW4_1.5 Series

10W - Dual/Single Output - 4:1 Wide Input - Isolated & Regulated DC-DC Converter

DC-DC Converter 10 Watt

- ⊕ 4:1 wide input voltage range
- ⊕ Efficiency up to 88%
- ⊕ 1.5kVDC isolation
- ⊕ Short circuit protection (SCP)
- ⊕ Output over voltage protection
- ⊕ Operating Temperature range: -40°C ~ +85°C
- ⊕ Six-sided metal shield
- ⊕ Industry standard pinout
- ⊕ Low ripple & noise
- ⊕ Meet CISPR22/EN55022 CLASS A Meet EN60950
- ⊕ Inverse polarity protection for chassis mounting

The 10DAW4 series are isolated 10W DC-DC products with 4:1 input voltage. They feature efficiency up to 88%, 1500VDC isolation, operating temperature of -40°C~+85°C, output over-voltage protection, short-circuit protection and EMI meets CISPR22/EN55022 CLASS A.

Widely applied in battery power supplies, industrial control, electricity, instruments, communication fields. An extension package with chassis mounting also enables them with reverse voltage protection.



Common specifications	
Short circuit protection:	Continuous, automatic recovery
Cooling:	Free air convection
Operation temperature range (power derating above 71°C):	-40°C~+85°C
Storage temperature range:	-55°C ~+125°C
Lead temperature range:	300°C MAX, 1.5mm from case for 10 sec
No-load power consumption:	500mW TYP
Switching frequency (PWM mode):	50KHz TYP
Storage humidity range:	< 95%
Vibration:	10-55Hz,10G,30 Min. along X, Y and Z
Case material:	Aluminium alloy
MTBF (MIL-HDBK-217F@25°C):	>1,000,000 hours
Weight:	22g / 44g (chassis-mounting)

Output specifications						
Item	Test condition	Min	Typ	Max	Units	
Output voltage accuracy	Refer to recommended circuit		±1	±2	%	
Output voltage balance	Dual outputs, balanced loads		±0.5	±1.5	%	
Line regulation	Full load, Input voltage from low to high • Main side • Secondary side		±0.2	±0.5	%	
Load regulation	5% to 100% load		±0.5	±1	%	
Cross regulation	Dual output, main output 50% load, secondary output from 10% to 100% load			±5	%	
Temperature coefficient	100% load			±0.03	%/°C	
Ripple&Noise*	20MHz Bandwidth		40	80	mVp-p	
Transient recovery time	25% load step change		300	500	µs	
Transient response deviation	25% load step change		±3	±5	%	
Output over voltage protection	Input voltage range	110	120	140	%	

Isolation specifications						
Item	Test condition	Min	Typ	Max	Units	
Isolation voltage	Tested for 1 minute and 1mA max	1500			VDC	
Isolation resistance	Test at 500VDC	1000			MΩ	
Isolation capacitance	Input/Output, 100KHz/0.1V		1000		pF	

Model selection:
WCTV_xxyyN##
W= Watt; C= Case; T= Type; V= Voltage Variation;
xx= Vin; yy= Vout; N= Numbers of Output; ##= Isolation (kVDC)

Example:
10DAW4_2405S1.5
10=10Watt; D= DIP; A=series; W4= wide input (4:1) 9-36Vin; 5Vout;
S=single output; 1.5=1500VDC

* Ripple and noise tested by "parallel cable" method. See detailed operation instructions at DC-DC application notes.

Input specifications						
Item	Test condition	Min	Typ	Max	Units	
Input filter	PI					
Hot plug	Unavailable					
Input current (full load/no load)	• 24VDC input • 48VDC input		508/12 254/6	521/21 261/11	mA	
Reflected ripple current	• 24VDC input • 48VDC input		40 30		mA	
Input impulse voltage (1sec. max)	• 24VDC input • 48VDC input	-0.7 -0.7		50 100	VDC	
Starting voltage	• 24VDC input • 48VDC input			9 18	VDC	
Ctrl ⁽¹⁾	• Models ON • Models OFF • Input current (models OFF)				Ctrl pin floating or connect to TTL high level (3.5-12VDC) Ctrl pin connected to GND or low level (0-1.2VDC)	
			1	3	mA	

- Note:**
- Min. load shouldn't be less than 5%, otherwise ripple may be increased dramatically, If the product operates under min. load, it may not be guaranteed to meet all specifications listed. Operation under minimum load will not damage the converter.
 - Recommended Dual output models unbalanced load is ≤±5%, If the product operates >±5%, it may not be guaranteed to meet all specifications listed. Please contact our technical support for more details.
 - Max. Capacitive Load is tested at input voltage range and full load.
 - All specifications measured at Ta = 25°C, humidity <75%, nominal input voltage and rated output load unless otherwise specified.
 - In this datasheet, all test methods are based on our corporate standards.
 - All characteristics are for listed models, and non-standard models may perform differently. Please contact our technical support for more details.
 - Please contact our technical support for any specific requirement.

1. The CTRL pin voltage is referenced to GND.

10DAW4_1.5 Series

10W - Dual/Single Output - 4:1 Wide Input - Isolated & Regulated
DC-DC Converter

EMC specifications				
EMI	CE	CISPR22/EN55022 CLASS A (bare component) CLASS B (see EMC solution-recommended circuit ²⁾)		
EMI	RE	CISPR22/EN55022 CLASS A (bare component) CLASS B (see EMC solution-recommended circuit ²⁾)		
EMS	ESD	IEC/EN61000-4-2	Contact ±4KV	perf. Criteria B
EMS	RS	IEC/EN61000-4-3	10V/m	perf. Criteria A
EMS	EFT	IEC/EN61000-4-4	±2KV	perf. Criteria B (see EMC solution-recommended circuit ¹⁾)
EMS	Surge	IEC/EN61000-4-5	±2KV	perf. Criteria B (see EMC solution-recommended circuit ¹⁾)
EMS	CS	IEC/EN61000-4-6	3 Vr.m.s	perf. Criteria A
EMS	Voltage dips, short and interruptions immunity	IEC/EN61000-4-29	0%-70%	perf. Criteria B

Part Number ¹⁾	Input Voltage [VDC]			Output Voltage [VDC]	Output current [mA]		Capacitive load ³⁾ [µF, Max.]	Efficiency ⁴⁾ [%, Typ.]
	Nominal	Range	Max ²⁾		Max	Min		
10DAW4_2403S1.5	24	9-36	40	3.3	2400	120	2200	79
10DAW4_2405S1.5	24	9-36	40	5	2000	100	2200	82
10DAW4_2412S1.5	24	9-36	40	12	833	42	470	86
10DAW4_2415S1.5	24	9-36	40	15	667	33	330	87
10DAW4_2424S1.5	24	9-36	40	24	416	21	100	87
10DAW4_4803S1.5	48	18-72	80	3.3	2400	120	2200	79
10DAW4_4805S1.5	48	18-72	80	5	2000	100	2200	82
10DAW4_4812S1.5	48	18-72	80	12	833	42	470	86
10DAW4_4815S1.5	48	18-72	80	15	667	33	330	87
10DAW4_4824S1.5	48	18-72	80	24	416	21	100	87
10DAW4_2405D1.5	24	9-36	40	±5	±1000	±50	680	83
10DAW4_2412D1.5	24	9-36	40	±12	±416	±21	220	86
10DAW4_2415D1.5	24	9-36	40	±15	±333	±16	100	88
10DAW4_4805D1.5	48	18-72	80	±5	±1000	±50	680	83
10DAW4_4812D1.5	48	18-72	80	±12	±416	±21	220	86
10DAW4_4815D1.5	48	8-72	80	±15	±333	±16	100	88

1) Suffix „X“ means the model with CTRL pin, for example 10DAW4_2403S1.5/X

2) Absolute maximum rating without damage on the converter;

3) For the dual output modules, the capacitive loads of positive and negative outputs are the same.

4) The efficiency of products with chassis mounting is 2% lower than the DIP package ones due to the reverse voltage protection;

Typical characteristics

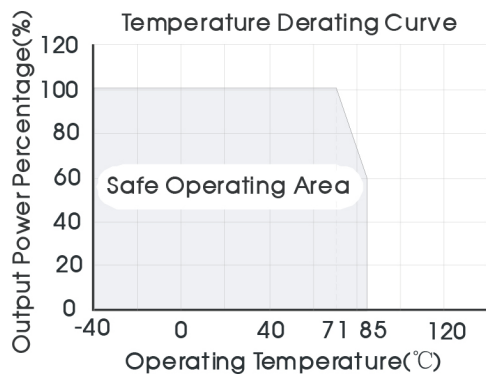

10DAW4_1.5 Series

10W - Dual/Single Output - 4:1 Wide Input - Isolated & Regulated DC-DC Converter

Efficiency

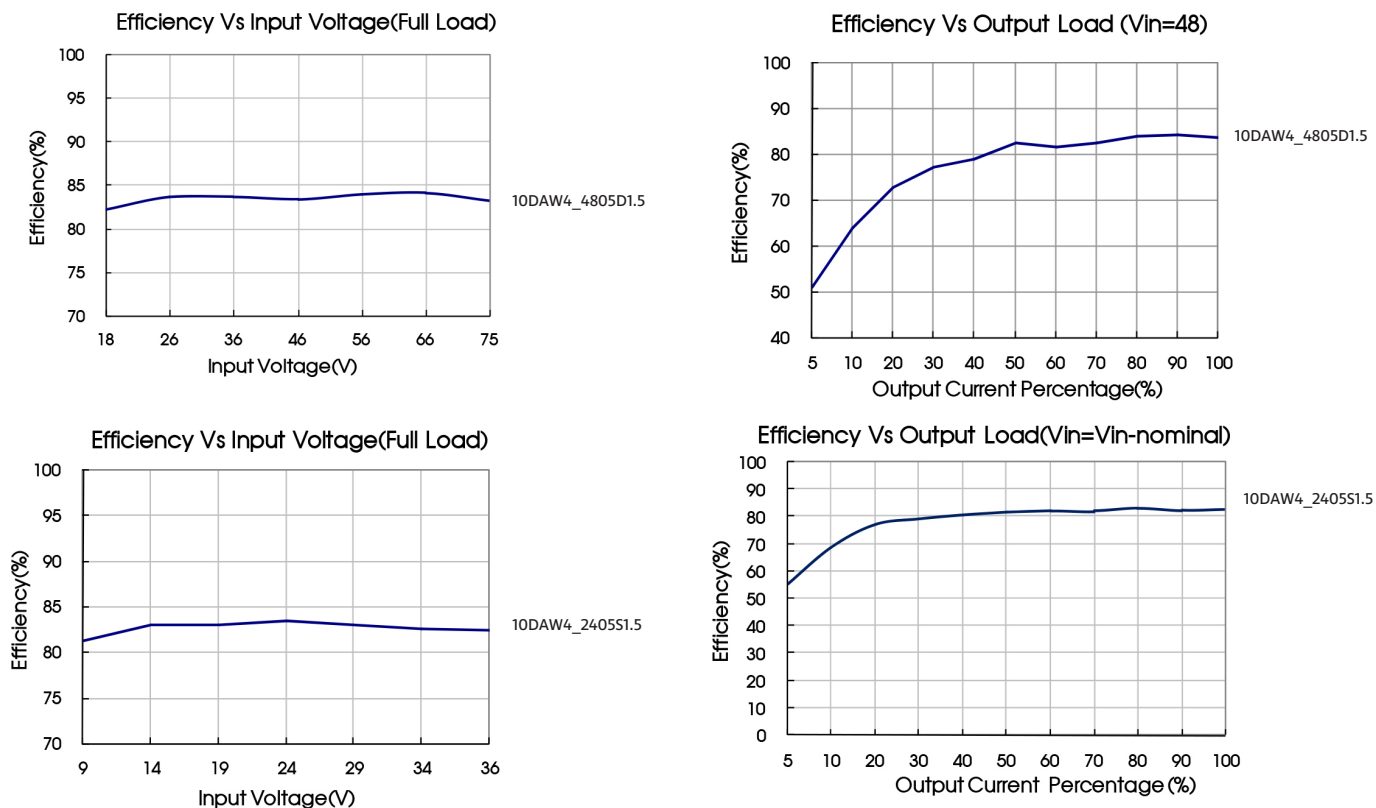

Recommended circuit

All the DC/DC converters of this series are tested according to the recommended circuit (see Fig. 1) before delivery. If a further decrease of the input and output ripple is required, properly increase the input & output of additional capacitors C_{in} and C_{out} or select capacitors of low equivalent impedance and ensure the capacitance should be lower than the max. capacitive load of the product.

C_{in}	C_{out}
10 μ F ~ 47 μ F	10 μ F

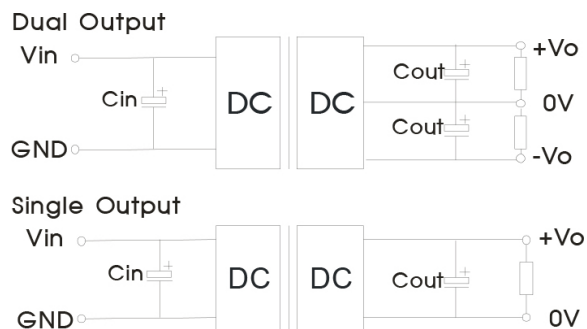
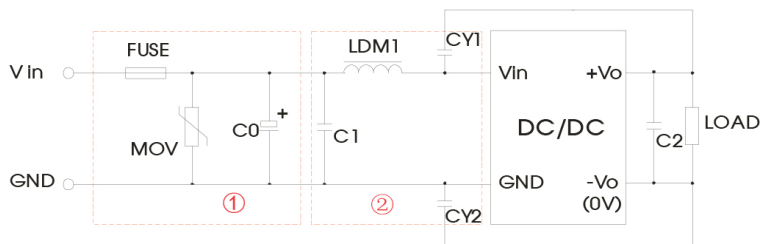

Figure 1

10DAW4_1.5 Series

10W - Dual/Single Output - 4:1 Wide Input - Isolated & Regulated DC-DC Converter

EMC solution-recommended circuit



Note:
Part ① is for EMS test, part ② is for EMI filtering
Choose according to requirements.

Parameter description:

Model	Vin: 24V	Vin: 48V
FUSE	Choose according to actual input current	
MOV	S14K35	S14K60
C0	330μF/50V	330μF/100V
C1	1μF/50V	1μF/100V
C2	Refer to the Cout in recommended circuit	
LDM1	4.7μH	
CY1	1nF/2KV	
CY2	1nF/2KV	

EMC recommended circuit PCB layout

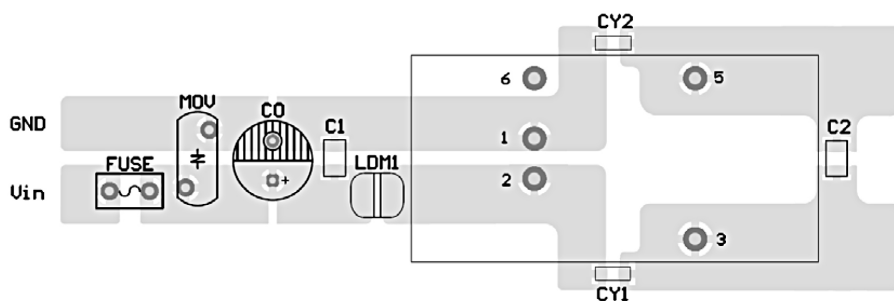

It is not allowed to connect modules output in parallel to enlarge the power.

Mechanical dimensions and footprint

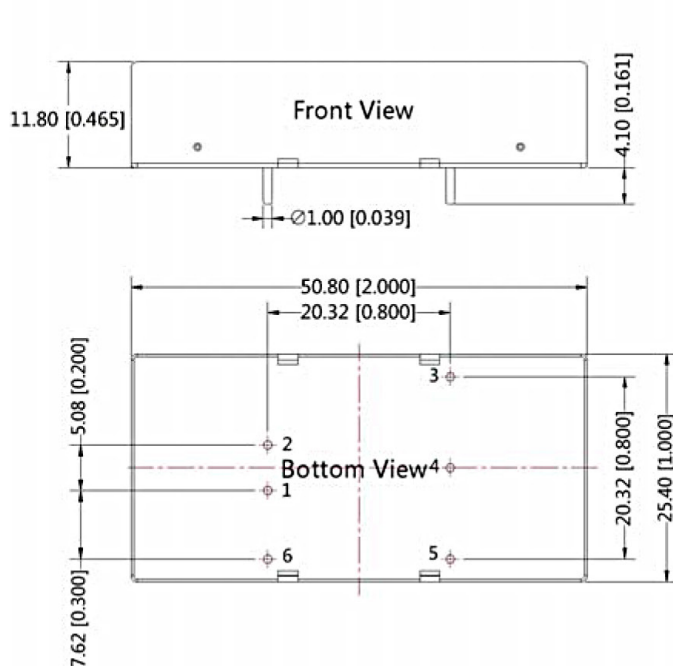

Note:
Unit: mm[inch]
Pin diameter tolerances: $\pm 0.10\text{mm}$ [$\pm 0.004\text{inch}$]
General tolerances: $\pm 0.50\text{mm}$ [$\pm 0.050\text{inch}$]

THIRD ANGLE PROJECTION

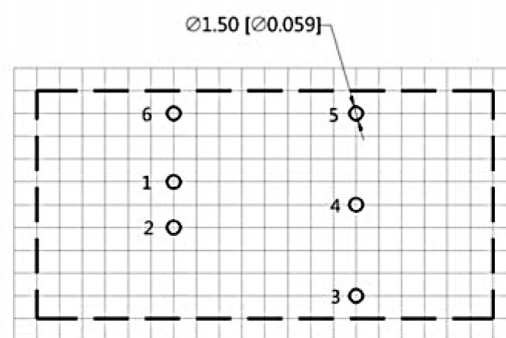

Note : Grid 2.54*2.54mm

Pin	Pin-Out	
	Single	Dual
1	GND	GND
2	Vin	Vin
3	+Vo	+Vo
4	No Pin	0V

10DAW4_1.5 Series

10W - Dual/Single Output - 4:1 Wide Input - Isolated & Regulated
DC-DC Converter

Chassis mounting

THIRD ANGLE PROJECTION 

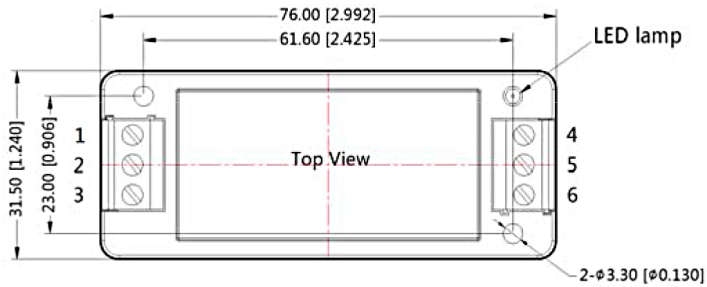

Pin-Out						
Pin	1	2	3	4	5	6
10DAW4_D1.5	Ctrl	GND	Vin	-Vo	0V	+Vo
10DAW4_S1.5	Ctrl	GND	Vin	0V	NC	+Vo

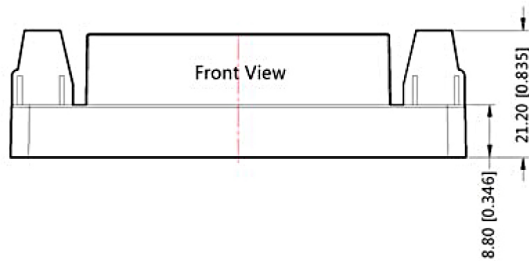

Note:
Unit:mm[inch]
Wire range:24~12 AWG
General tolerances:±0.50[±0.020]