

ECN/PCN No.: 4111

For Manufacturer			
Product Description: PLASTIC SMD MEMS OSCILLATOR	Abracon Part Number / Part Series: ASTMK06	<input type="checkbox"/> Documentation only <input type="checkbox"/> ECN <input checked="" type="checkbox"/> EOL	<input checked="" type="checkbox"/> Series <input type="checkbox"/> Part Number
Affected Revision: A	New Revision: EOL	Application:	<input type="checkbox"/> Safety <input checked="" type="checkbox"/> Non-Safety
Prior to Change: Active https://abracon.com/Oscillators/ASTMK06.pdf			
After Change: EOL			
Cause/Reason for Change: Discontinuation of manufacturing capability.			
Change Plan			
Effective Date: 2/7/2022	Additional Remarks: N/A		
Change Declaration: N/A			
Issued Date: 2/7/2022	Issued By: <i>Brooke Cushman Product Engineer</i>	Issued Department: Engineering	
Approval: <i>Thomas Culhane Engineering Director</i>	Approval: <i>Reuben Quintanilla Quality Director</i>	Approval: <i>Ying Huang Purchasing Director</i>	
For Abracon EOL only			
Last Time Buy (if applicable): 5/7/2022	Alternate Part Number / Part Series: none		
Additional Approval:	Additional Approval:	Additional Approval:	
Customer Approval (If Applicable)			
Qualification Status: <input type="checkbox"/> Approved <input type="checkbox"/> Not accepted <i>Note: It is considered approved if there is no feedback from the customer 1 month after ECN/PCN is released.</i>			
Customer Part Number:		Customer Project:	
Company Name:	Company Representative:	Representative Signature:	
Customer Remarks:			

Ultra-miniature, Low Power, 32.768kHz SMD MEMS Oscillator



2.0 x 1.2 x 0.6mm

ASTMK06



RoHS/RoHS II compliant

Moisture Sensitivity Level (MSL) – 1

FEATURES:

- Ultra-miniature size: 2.0 x 1.2 x 0.6mm
- Supply Voltage: 1.5V to 3.63V
- Ultra-Low Current Consumption: 1.0µA typ.(no load)
- Frequency Stabilities include:
 - ±75ppm over -10 to +70°C
 - ±100ppm over -40 to +85°C
- Internal power supply filtering eliminates external bypass capacitor for Vdd port.

APPLICATIONS:

- General Timekeeping
- Battery Management
- Portable devices
- RTC reference clock
- Bluetooth/WiFi modules

STANDARD SPECIFICATIONS:

Parameters	Min	Typ	Max	Unit	Notes
Output Frequency (F _{out})	32.768			kHz	
Initial Frequency Tolerance (F _{init}) ⁽¹⁾	-20		+20	ppm	T _A = +25°C, post reflow, V _{dd} :1.5-3.63V
Frequency Stability over Temperature (F _{stab}) ⁽²⁾	-75		+75	ppm	T _A = -10°C to +70°C, V _{dd} :1.5-3.63V
	-100		+100		T _A = -40°C to +85°C, V _{dd} :1.5-3.63V
Aging (@+25°C)	-1		+1	ppm	First year
Supply Voltage (V _{dd})	1.5		3.63	V	T _A = over temperature
Current Consumption (I _{dd})		1.0		µA	T _A = +25°C, V _{dd} :1.5-3.63V. No load.
			1.9		T _A = -10°C to +70°C, V _{dd} max: 3.63V. No load
			2.2		T _A = -40°C to +85°C, V _{dd} max: 3.63V. No load.
Power Supply Ramp (t _{ydd_Ramp})			100	ms	Over temperature, 0 to 90% V _{dd}
Start-up Time at Power-up (T _{start})		180	300	ms	T _A = +25°C±10°C
			450		T _A = -40°C to +70°C
			500		T _A = +85°C
Operating Temperature Range (T _{use})	-10		+70	°C	Option "M"
	-40		+85		Option "L"
LVC MOS Output (T _A = Over Temperature. Typical values are at T _A = +25°C)					
Output Rise/Fall Time (t _r /t _f)		100	200	ns	10-90%, 15pF load, V _{dd} :1.5-3.63V
Output Clock Duty Cycle	48		52	%	
Output Voltage	V _{OH}	90%*V _{dd}		V	V _{dd} :1.5-3.63V. I _{OH} = -10µA, 15pF
	V _{OL}		10%*V _{dd}		V _{dd} :1.5-3.63V. I _{OL} = 10µA, 15pF
Output Drive Level			50	pF	≥80% LVC MOS swing, V _{dd} :1.8V, 2.5V, 3.3V
Period Jitter (T _{jitt})		35		ns _{RMS}	Cycles – 10000, T _A = +25°C

Note:

1. Measured peak-to-peak. Tested with Agilent 53132A frequency counter. Due to the low operating frequency, the gate time must be ≥100ms to ensure an accurate frequency measurement.
2. Measured peak-to-peak. Inclusive of initial tolerance at +25°C, and variations over operating temperature, rated power supply voltage and load.

Ultra-miniature, Low Power, 32.768kHz SMD MEMS Oscillator



2.0 x 1.2 x 0.6mm

ASTMK06



RoHS/RoHS II compliant

Absolute Maximum Ratings

Attempted operation outside the absolute maximum ratings may cause permanent damage to the part. Actual performance of the IC is only guaranteed within the operational specifications, not at absolute maximum ratings.

Parameters	Test Condition	Value	Unit
Continuous Power Supply Voltage Range (V_{dd})		-0.5 to 3.63	V
Short Duration Max. Power Supply Voltage (V_{dd})	≤ 30 minutes	4.0	V
Short Duration Max. Operating Temperature Range	V_{dd} : 1.5-3.63V, ≤ 30 minutes	125	$^{\circ}\text{C}$
Human Body Model (HBM) ESD Protection	JESD22-A114	3000	V
Charge-Device Model (CDM) ESD Protection	JESD22-C101	750	V
Machine Model (MM) ESD Protection	JESD22-A115	300	V
Latch-up Tolerance	JESD78 Compliant		
Mechanical Shock Resistance	Mil 883, Method 2002	10000	g
Mechanical Vibration Resistance	Mil 883, Method 2007	70	g
2012 SMD Junction Temperature		150	$^{\circ}\text{C}$
Storage Temperature		-65 to +150	$^{\circ}\text{C}$

Block Diagram:

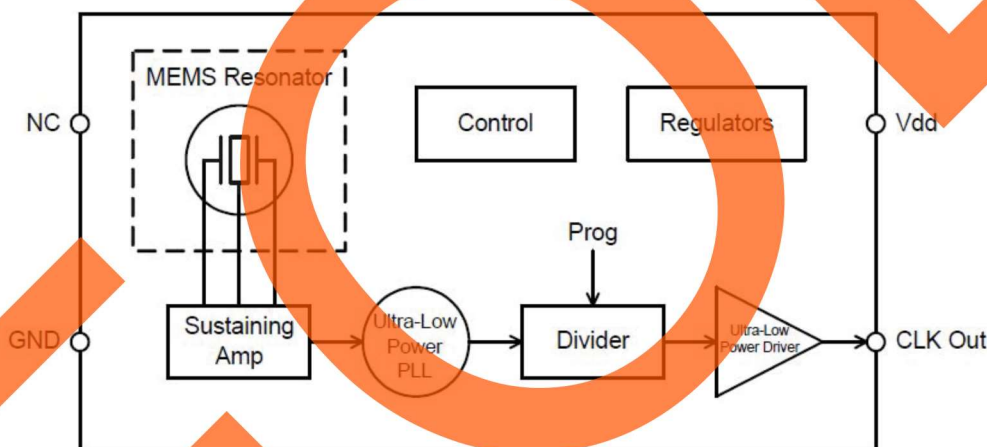

PART IDENTIFICATION:

ASTMK06 - 32.768 kHz - - -

Operating Temp.
M: $-10^{\circ}\text{C} \sim +70^{\circ}\text{C}$
L: $-40^{\circ}\text{C} \sim +85^{\circ}\text{C}$

Freq. Stability
P: $\pm 75\text{ppm}$ ($-10^{\circ}\text{C} \sim +70^{\circ}\text{C}$ only)
Q: $\pm 100\text{ppm}$ ($-40^{\circ}\text{C} \sim +85^{\circ}\text{C}$ only)

Packaging
Blank: Bulk
T3: Tape & Reel (3kpcs / reel)
T10: Tape & Reel (10kpcs / reel)

Ultra-miniature, Low Power, 32.768kHz SMD MEMS Oscillator



2.0 x 1.2 x 0.6mm

ASTMK06



RoHS/RoHS II compliant

TYPICAL PERFORMANCE DATA (TA=25°C, Vdd=1.8V, unless otherwise stated)

Initial Tolerance Histogram

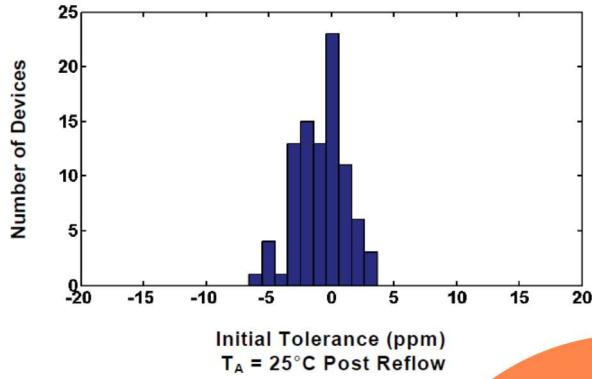

Frequency Stability vs. Operating Temperature Range

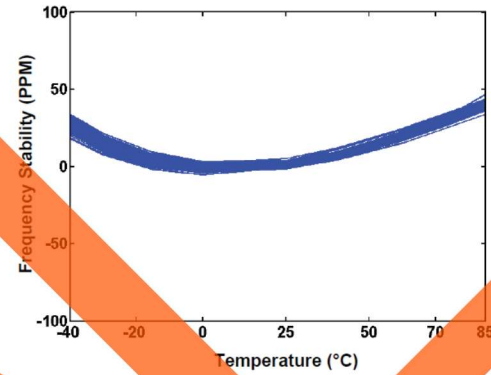

Supply Current vs Operating Temperature Range (No Load)

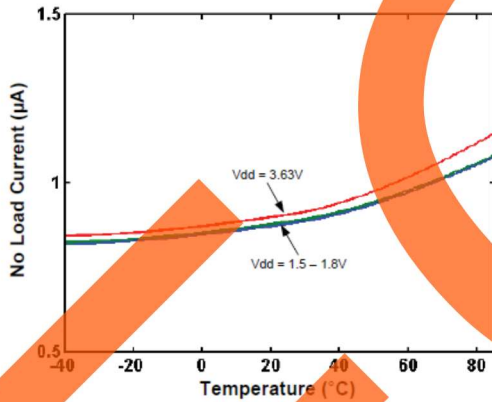

Start-up Time

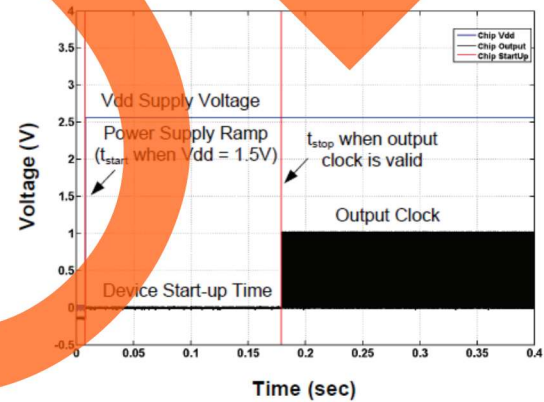

Power Supply Noise Rejection (±150mV Noise)

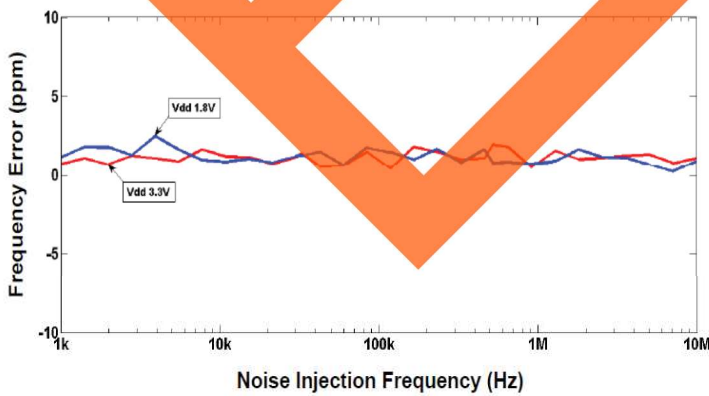

LVC MOS Output Waveform (V_{swing} = 1.8V)

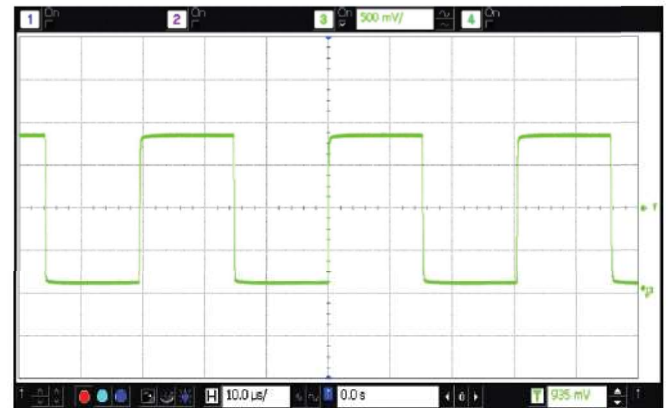

Ultra-miniature, Low Power, 32.768kHz SMD MEMS Oscillator

ASTMK06



RoHS/RoHS II compliant



2.0 x 1.2 x 0.6mm

OUTLINE DRAWING:

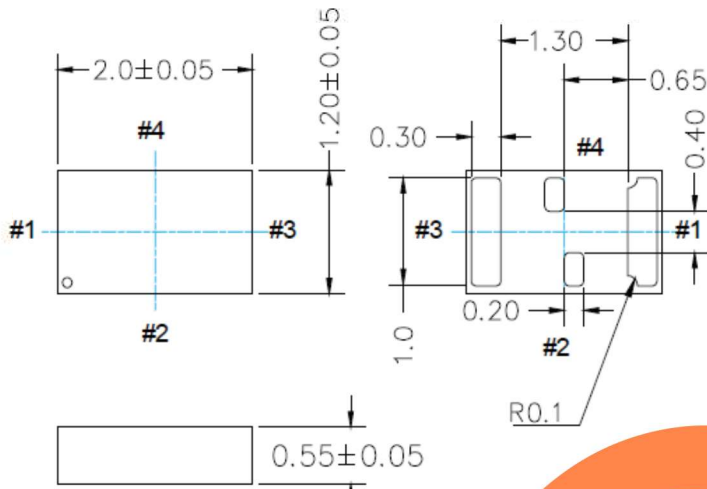

Recommended Land Pattern

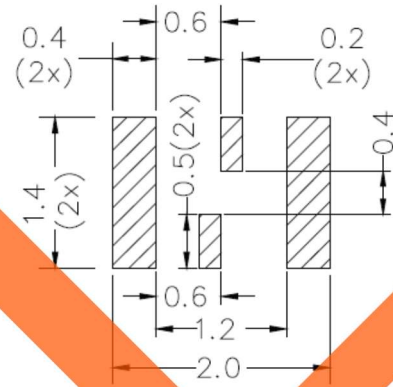

Pin	Name	I/O	Functionality
1	NC	No Connect	No connection. Will not respond to any input signal
2	GND	Power Supply Ground	Connect to ground. All GND pins must be connected to power supply ground.
3	CLK Out	OUT	Oscillator clock output.
4	V _{dd}	Power Supply	Connect to power supply $1.5V \leq V_{dd} \leq 3.63V$. Under normal operating conditions, V _{dd} doesn't require external bypass/decoupling capacitor(s). Internal power supply filtering will reject more than $\pm 150mV_{pp}$ with frequency components through 10MHz

Dimensions: mm

REFLOW PROFILE:

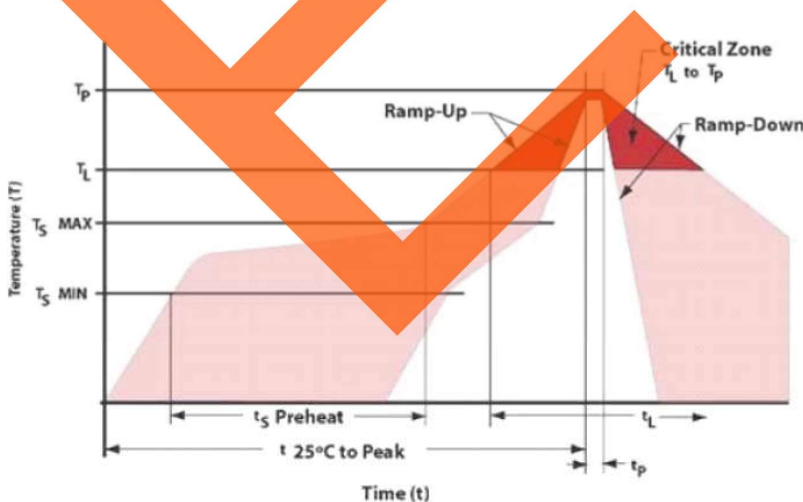

Item	Conditions
T _S MAX to T _L (Ramp-up Rate)	3°C/second max
Preheat	
Temperature Minimum (T _S MIN)	150°C
Temperature Typical (T _S TYP)	175°C
Temperature Maximum (T _S MAX)	200°C
Time (t _s)	60 – 180 seconds
Ramp-up Rate (T _L to T _p)	3°C/second max
Time Maintained Above	
Temperature (T _L)	217°C
Time (t _L)	60 – 150 seconds
Peak Temperature (T _p)	260°C max
Target Peak Temperature (T _p Target)	255°C
Time within 5°C of actual peak (t _p)	20 – 40 seconds
Max. Number of Reflow Cycles	3
Ramp-down Rate	6°C/second max
Time 25°C to Peak Temperature (t)	8 minutes max

Ultra-miniature, Low Power, 32.768kHz SMD MEMS Oscillator



2.0 x 1.2 x 0.6mm

ASTMK06

Pb RoHS/RoHS II compliant

TAPE & REEL:

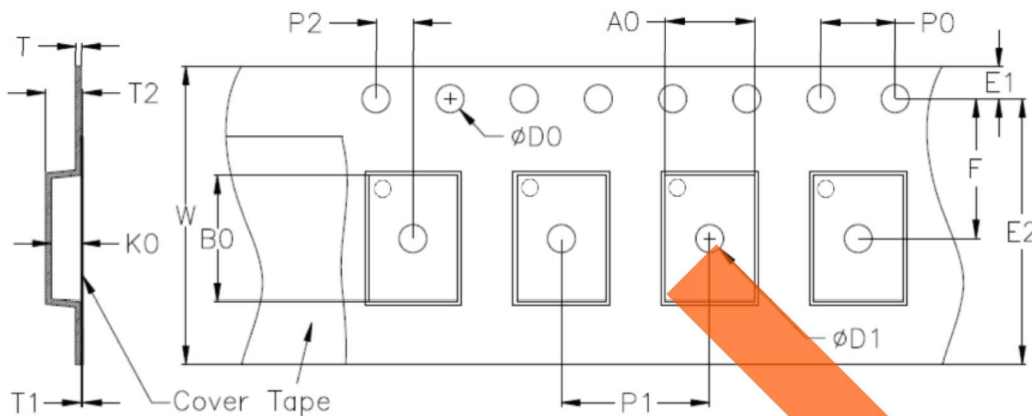

D0	D1 min.	E1	E2 min.	F	P0	P1	P2
1.55±0.05	1.0	1.75±0.1	6.05	3.5±0.05	4.0±0.1	4.0±0.1	2.0±0.05
T	T1 max.	T2 max.	W max.	A0	B0	K0	
0.25±0.05	NA	NA	8.3	1.6±0.05	2.25±0.10	0.65±0.05	

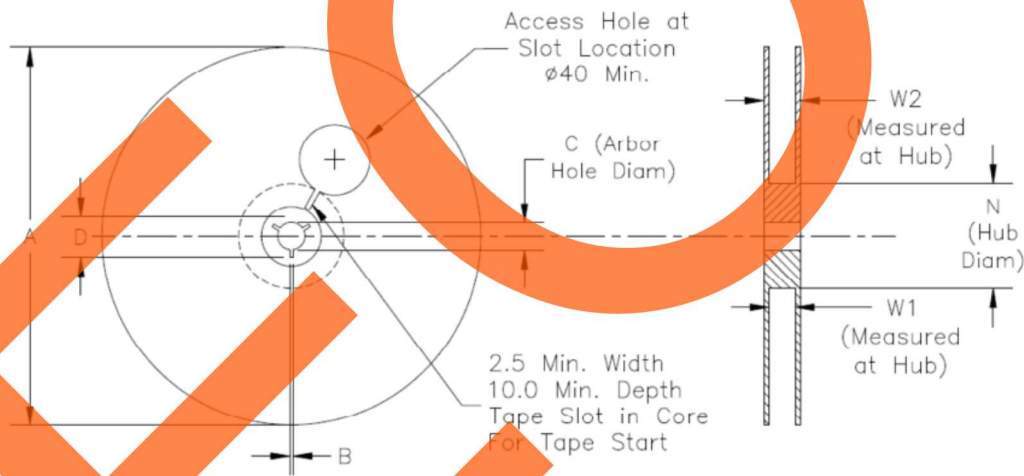

Option	A max.	B min.	C	D min.	N	W1	W2 max.
T3	180.5	1.5	13.0+0.6/-0.2	20.2	60±0.5	8.4+1.5/-0	14.4
T10	330	1.5	13.0±0.2	20.2	100±0.5	8.4+1.5/-0	14.4

T3= Tape and reel (3,000pcs/reel)
T10= Tape and reel (10,000pcs/reel)

Unit: mm

ATTENTION: Abracon LLC's products are COTS – Commercial-Off-The-Shelf products; suitable for Commercial, Industrial and, where designated, Automotive Applications. Abracon's products are not specifically designed for Military, Aviation, Aerospace, Life-dependent Medical applications or any application requiring high reliability where component failure could result in loss of life and/or property. For applications requiring high reliability and/or presenting an extreme operating environment, written consent and authorization from Abracon LLC is required. Please contact Abracon LLC for more information.



5101 Hidden Creek Ln Spicewood TX 78669
Phone: 512-371-6159 | Fax: 512-351-8858
For terms and conditions of sales, please visit:
www.abracon.com

REVISED: 05.27.2021

ABRACON IS
ISO9001-2015
CERTIFIED