

Revision Level			Revision Record	Changed	Date	Approved	Date
Drawing	State	Part					
01.2	Design Release		SEE ECN# 014403	FDS	4/20/18	EJH	4/20/18

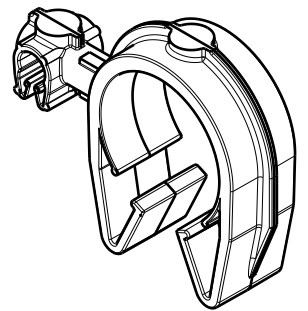

ISOMETRIC VIEW

CLIPS ROTATE 360 DEGREES

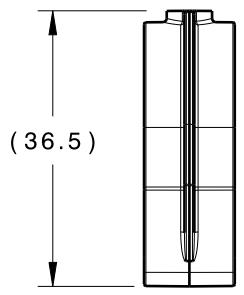
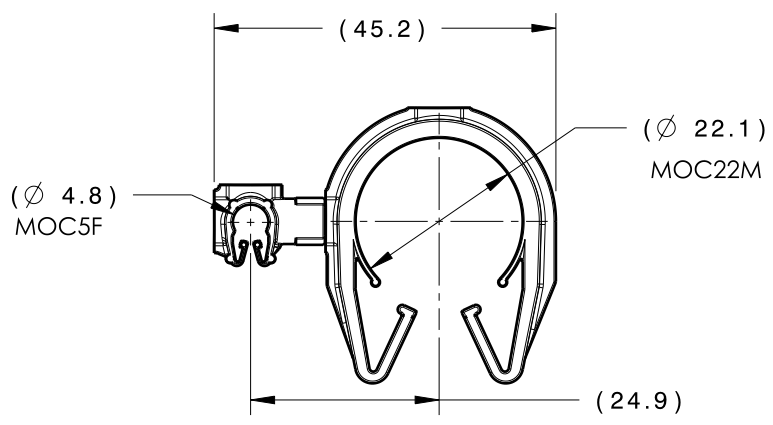
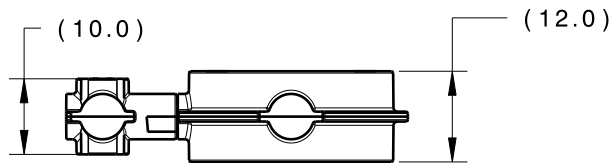
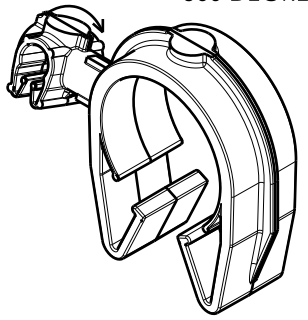

ISOMETRIC VIEW ROTATED

TYPE	MOC5F	MOC22M
HARNESS	4.5MM-5.3MM	20.0MM-24.0MM
HOSE	4.0MM-5.3MM	20.0MM-24.0MM
HARD PIPE/TUBE	4.8MM-5.5MM	22.0MM-25.0MM

*RECOMMENDED SIZES MAY DIFFER DEPENDING ON THE APPLICATION , PRODUCT REQUIREMENTS AND MATERIALS USED

**PATENT PENDING 29/582,271

GLOBAL PART DESCRIPTION 	MOC5F			MOC22M**		
	DRAWING	MATERIAL	COLOR	DRAWING	MATERIAL	COLOR
MOC5FMOC22M-PA66HIRHSUV-BK	16-0313-000-CSU	PA66HIRHSUV	BLACK	16-0323-000-CSU	PA66HIRHSUV	BLACK

Material SEE CHART COLOR: SEE CHART	Units millimeters	The copyright of this drawing is reserved by HellermannTyton. It is issued on condition that it is not reproduced, copied or disclosed to a third party, either wholly or in part, without the consent of HellermannTyton.	Drawn	TAT	2/20/17	Article/Type-No	MOC5FMOC22M	Scale	1:1
	Tolerance defined on each dimension		Approved	EJH	2/28/17	Title	 5MM MOC COUPLED TO A 22MM MOC	Project Number	16-0326
			HellermannTyton North America Email: corp@htamericas.com Web: www.hellermann.tyton.com			Drawing-No	PRODUCTION : Phase	Format	AH
						16-0326-174-CSU 		Sheet	1/1