

Antenna

YC0009AA Datasheet

Antenna Services

Version: 1.2

Date: 2021-06-25

Status: Released



Our aim is to provide customers with timely and comprehensive service. For any assistance, please contact our company headquarters:

Quectel Wireless Solutions Co., Ltd.

Building 5, Shanghai Business Park Phase III (Area B), No.1016 Tianlin Road, Minhang District, Shanghai 200233, China

Tel: +86 21 5108 6236

Email: info@quectel.com

Or our local office. For more information, please visit:

<http://www.quectel.com/support/sales.htm>.

For technical support, or to report documentation errors, please visit:

<http://www.quectel.com/support/technical.htm>

Or email to support@quectel.com.

General Notes

Quectel offers the information as a service to its customers. The information provided is based upon customers' requirements. Quectel makes every effort to ensure the quality of the information it makes available. Quectel does not make any warranty as to the information contained herein, and does not accept any liability for any injury, loss or damage of any kind incurred by use of or reliance upon the information. All information supplied herein is subject to change without prior notice.

Disclaimer

While Quectel has made efforts to ensure that the functions and features under development are free from errors, it is possible that these functions and features could contain errors, inaccuracies and omissions. Unless otherwise provided by valid agreement, Quectel makes no warranties of any kind, implied or express, with respect to the use of features and functions under development. To the maximum extent permitted by law, Quectel excludes all liability for any loss or damage suffered in connection with the use of the functions and features under development, regardless of whether such loss or damage may have been foreseeable.

Duty of Confidentiality

The Receiving Party shall keep confidential all documentation and information provided by Quectel, except when the specific permission has been granted by Quectel. The Receiving Party shall not access or use Quectel's documentation and information for any purpose except as expressly provided herein. Furthermore, the Receiving Party shall not disclose any of the Quectel's documentation and information to any third party without the prior written consent by Quectel. For any noncompliance to the above requirements, unauthorized use, or other illegal or malicious use of the documentation and information, Quectel will reserve the right to take legal action.

Copyright

The information contained here is proprietary technical information of Quectel. Transmitting, reproducing, disseminating and editing this document as well as using the content without permission are forbidden. Offenders will be held liable for payment of damages. All rights are reserved in the event of a patent grant or registration of a utility model or design.

Copyright © Quectel Wireless Solutions Co., Ltd. 2021. All rights reserved.

About the Document

Revision History

Version	Date	Author	Note
-	2020-09-20	Kenny YIN	Creation of the document
1.0	2020-09-20	Kenny YIN	First official release
1.1	2021-01-12	Kenny YIN	Updated the antenna image in Chapter 2.
1.2	2021-06-25	Aria CHU	Updated VSWR values in Chapter 3.

Contents

About the Document.....	3
Contents.....	4
1 Product Description.....	5
2 Product Features	5
3 Product Specifications	6
4 Overall Performance.....	7
4.1. Test Environment	7
4.2. Return Loss.....	8
4.3. Efficiency	8
4.4. Gain.....	8
4.5. Radiation Pattern	9
4.6. Reference PCB Design (Unit: mm).....	11
5 Product Size	12
6 Reliability Test.....	13
6.1. Vibration Resistance	13
6.2. Drop and Shock Tests	13
6.3. Resistance to Soldering Heat	13
6.4. Adhesive Strength of Termination.....	13
6.5. Bending Resistance Test	14
6.6. Moisture Proof.....	14
6.7. High Temperature Endurance	14
6.8. Low Temperature Endurance.....	14
6.9. Temperature Cycle Test	14
7 Reflow Soldering Standard Condition.....	15
8 Packaging and Dimensions	16
8.1. Plastic Tape	16
8.2. Reel (3000 pcs/reel).....	16

1 Product Description

The antenna is designed for superior performance, and can be widely used for wireless applications.

We provide comprehensive antenna design support such as simulation, testing and manufacturing for custom antenna solutions to meet your specific application needs.

2 Product Features

- Wi-Fi/Bluetooth
- High efficiency
- Excellent performance



3 Product Specifications

Passive Electrical Specifications

Frequency Range	2400–2500 MHz
Input Impedence	50 Ω
VSWR	≤ 2.0
Gain	≤ 4 dBi
Polarization Type	Linear

Mechanical Specifications

Antenna Size	3.2 mm \times 1.6 mm \times 0.5 mm
Casing	-
Radiator	Ceramic patch
Connector Type	SMD
Working Temperature	-40 $^{\circ}$ C to +85 $^{\circ}$ C
Radome Color	-

4 Overall Performance

4.1. Test Environment

- KEYSIGHT VNA Network Analyzer E5063A, 100 kHz – 8.5 GHz
- RayZone® 2800 Chamber 5G (FR1) SISO/MIMO, 400 MHz – 8.0 GHz



4.2. Return Loss

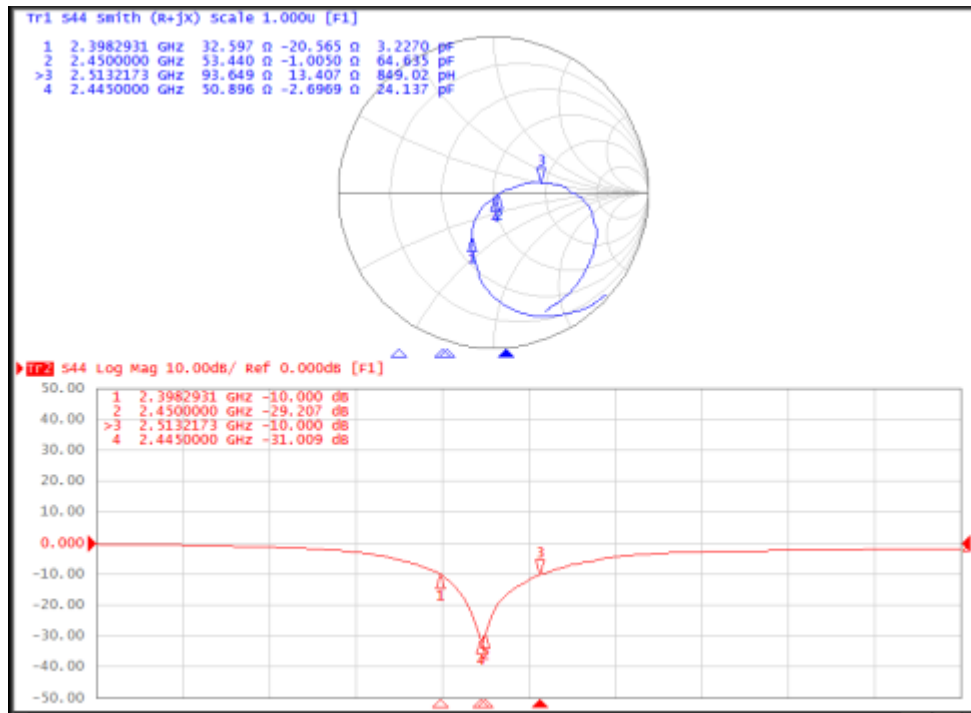

Frequency (MHz)	2390	2450	2513
Return Loss	-10	-29.2	-10

4.3. Efficiency

Frequency (MHz)	2400	2450	2500
Efficiency (%)	72.1	78.2	71.8

4.4. Gain

Frequency (MHz)	2400	2450	2500
Gain	1.76	4.08	2.53

4.5. Radiation Pattern

coordinates:

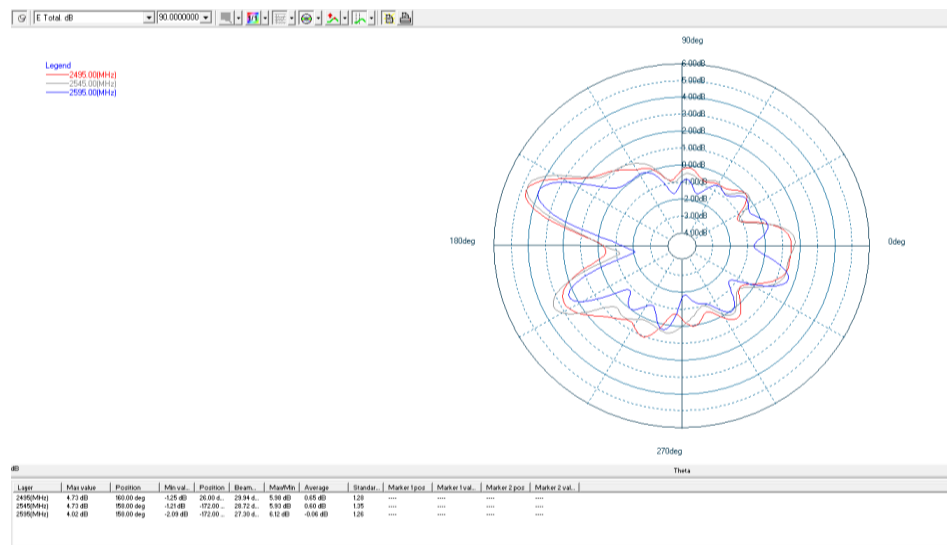
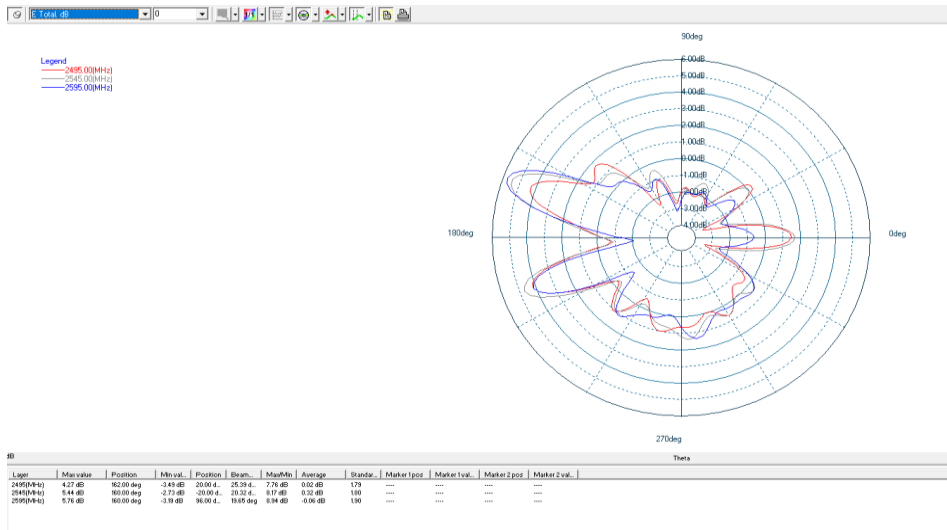
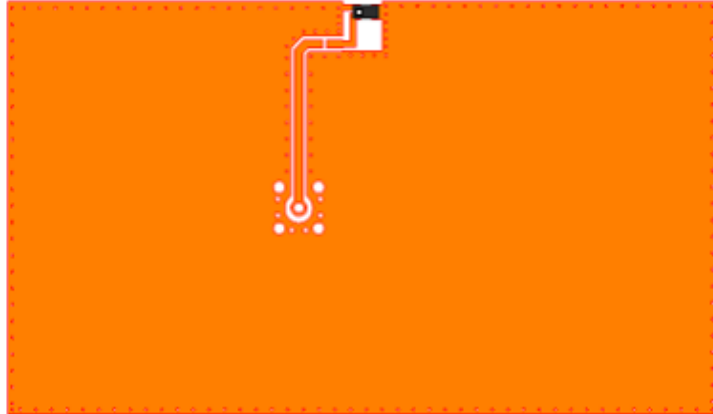
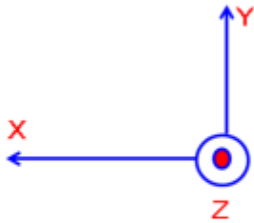

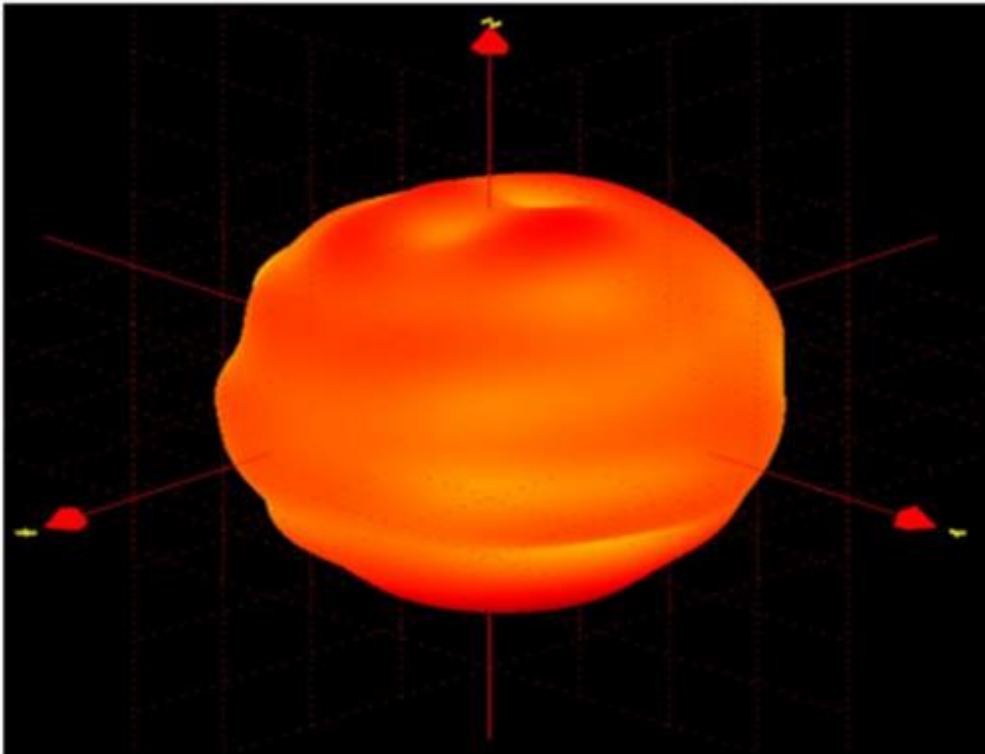
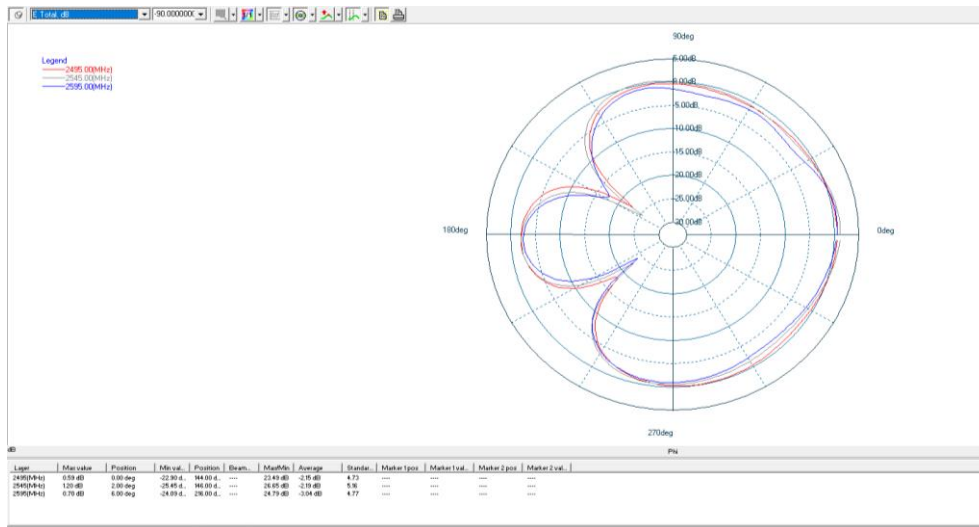

4.6. Reference PCB Design (Unit: mm)

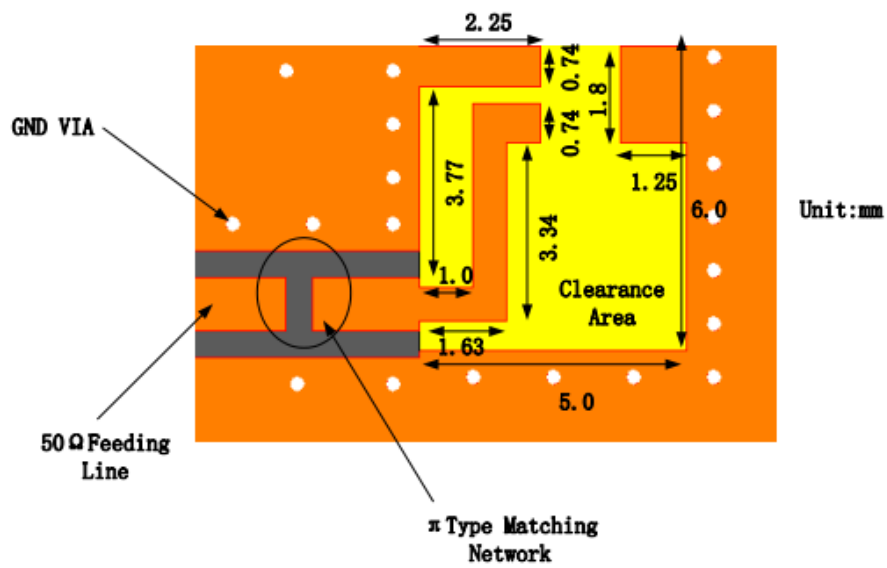
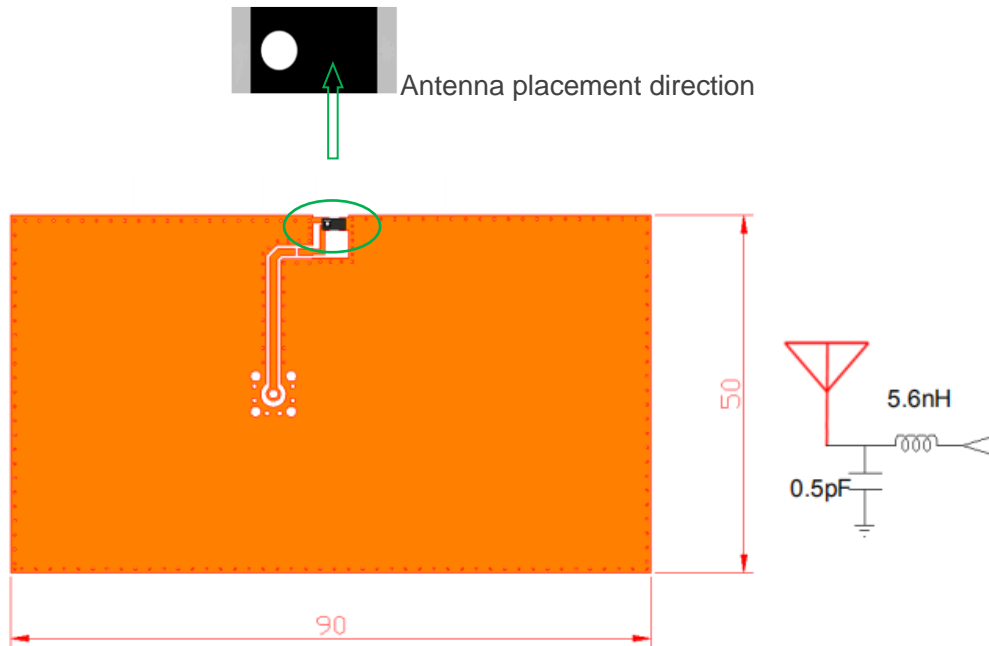

5 Product Size

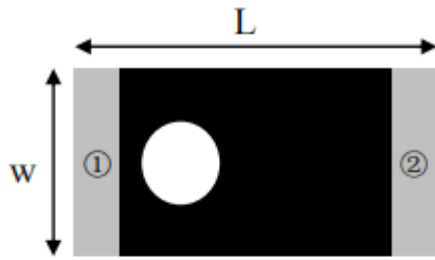

(Top View)

Number	Terminal Name
①	INPUT
②	NC



(Bottom View)



(Side View)

Symbols	L	W	T	A
Dimensions	3.2+/-0.2	1.6+/-0.2	0.5+/-0.1	0.4+/-0.1

6 Reliability Test

Temperature Range	25 ±5 °C
Relative Humidity Range	55–75 %
Operating Temperature Range	-40 °C to +85 °C
Storage Temperature Range	-40 °C to +85 °C

6.1. Vibration Resistance

The device should fulfil the electrical specification after being applied to the vibration of 10–55 Hz with amplitude of 1.5 mm for 2 hours in X, Y and Z directions respectively.

6.2. Drop and Shock Tests

The device should have no mechanical damage after dropping onto the hard wooden board from the height of 100 cm for 3 times at each facet of the 3 dimensions of the device.

6.3. Resistance to Soldering Heat

The device should have no damage after pre-heating at 120–150 °C for 120 seconds and immersion in Sn solder at 255 ±10 °C for 5 ±0.5 seconds, or electric iron at 300 ±10 °C for 3 ±0.5 seconds.

6.4. Adhesive Strength of Termination

The device have no remarkable damage or removal of the termination after horizontal force of 5 N (\leq 0603); 10 N ($>$ 0603) for 10 ±1 seconds.

6.5. Bending Resistance Test

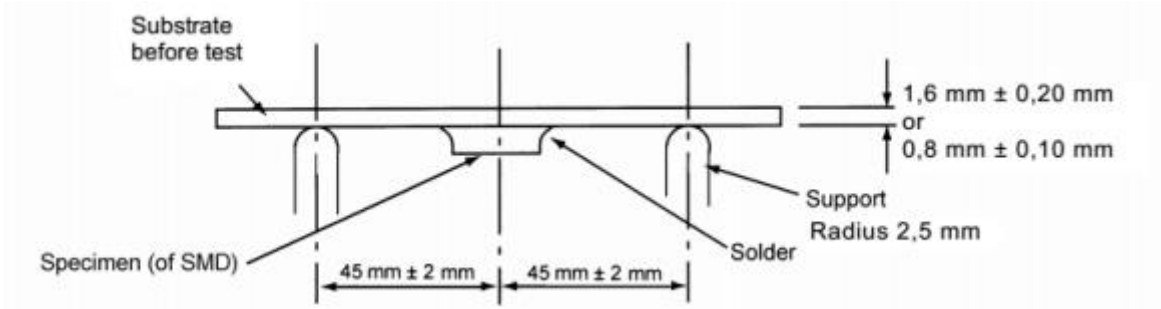

Weld the product to the central part of the PCB with the thickness 1.6 ± 0.2 mm or 0.8 ± 0.1 mm as the illustration shows, and keep exerting force arrow-ward on it at speed of 1 mm/s, and hold for 5 ± 1 seconds at the position of 1.5 mm bending distance, so far, any peeling-off of the product metal coating should not be detected.

6.6. Moisture Proof

The device should fulfil the electrical specifications after being exposed to the temperature 60 ± 2 °C and the relative humidity 90–95 % for 96 hours and experiencing 1–2 hours recovery time under normal condition.

6.7. High Temperature Endurance

The device should fulfil the electrical specifications after being exposed to temperature 85 ± 5 °C for 96 ± 2 hours and experiencing 1–2 hours recovery time under normal temperature.

6.8. Low Temperature Endurance

The device should fulfil the electrical specifications after being exposed to the temperature -40 °C ± 5 °C for 96 ± 2 hours and experiencing 2 hours recovery time under normal temperature.

6.9. Temperature Cycle Test

The device should fulfil the electrical specifications after being exposed to the low temperature -40 °C and high temperature $+85$ °C for 30 ± 2 minutes each by 5 cycles and experiencing 1 to 2 hours recovery time under normal temperature.

7 Reflow Soldering Standard Condition

