

KW CSLPM2.PC

OSLON® Square Flat

The most compact 3 x 3 mm high power LED with an electrically isolated thermal pad allows for superior heat dissipation designs. The flat package shape enhances color homogeneity due to reduced color over angle variation. Extremely low thermal resistance helps to maintain the efficiency remarkably high even when driven at higher currents.

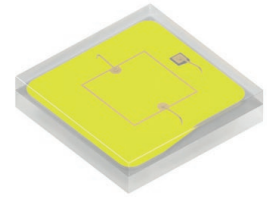

Applications

- Architecture
- Highbay Industrial
- Industrial Automation (Machine Controls, Light Barriers, Vision Controls)
- Lamp Retrofits
- Street, Tunnel and Outdoor
- Transportation, Plane, Ship

Features:

- Package: Ceramic package
- Chip technology: UX:3
- Color: Cx = 0.32, Cy = 0.33 acc. to CIE 1931 (• white)
- Corrosion Robustness Class: 3B
- Color temperature: 5000K - 6500K
- CRI: 70
- ESD: 8 kV acc. to ANSI/ESDA/JEDEC JS-001 (HBM, Class 3B)

Ordering Information

Type	Color temperature	Luminous Flux ¹⁾ I _F = 700 mA Φ _v	Ordering Code
KW CSLPM2.PC-7M7N-4H8I	5000 K	224 ... 400 lm	Q65112A7975
KW CSLPM2.PC-7M7N-4F8G	5700 K	224 ... 400 lm	Q65112A2577
KW CSLPM2.PC-7M7N-4C8E	6500 K	224 ... 400 lm	Q65112A2444

Maximum Ratings

Parameter	Symbol		Values
Operating Temperature	T_{op}	min.	-40 °C
		max.	125 °C
Storage Temperature	T_{stg}	min.	-40 °C
		max.	125 °C
Junction Temperature	T_j	max.	135 °C
Forward Current $T_s = 25\text{ °C}$	I_F	min.	200 mA
		max.	1800 mA
ESD withstand voltage acc. to ANSI/ESDA/JEDEC JS-001 (HBM, Class 3B)	V_{ESD}		8 kV
Reverse current ²⁾	I_R	max.	200 mA

Characteristics

$I_F = 700 \text{ mA}$; $T_s = 25 \text{ °C}$

Parameter	Symbol		Values
Chromaticity Coordinate ³⁾	C_x	typ.	0.32
	C_y	typ.	0.33
Forward Voltage ⁴⁾ $I_F = 700 \text{ mA}$	V_F	min.	2.70 V
		typ.	2.85 V
		max.	3.20 V
Reverse voltage (ESD device)	$V_{R\text{ESD}}$	min.	45 V
Reverse voltage ²⁾ $I_R = 20 \text{ mA}$	V_R	max.	1.2 V
Color Rendering Index	CRI	typ.	70
Real thermal resistance junction/solderpoint ⁵⁾	$R_{\text{thJS real}}$	typ.	3.0 K / W
		max.	3.9 K / W
Electrical thermal resistance junction/solderpoint ⁵⁾ with efficiency $\eta_e = 42 \%$	$R_{\text{thJS elec.}}$	typ.	1.7 K / W
		max.	2.3 K / W

Brightness Groups

Group	Luminous Flux ¹⁾ $I_F = 700 \text{ mA}$ min. Φ_V	Luminous Flux ¹⁾ $I_F = 700 \text{ mA}$ max. Φ_V	Luminous Intensity ⁶⁾ $I_F = 700 \text{ mA}$ typ. I_V
7M	224 lm	250 lm	78 cd
8M	250 lm	280 lm	88 cd
5N	280 lm	315 lm	98 cd
6N	315 lm	355 lm	111 cd
7N	355 lm	400 lm	125 cd

Chromaticity Coordinate Groups

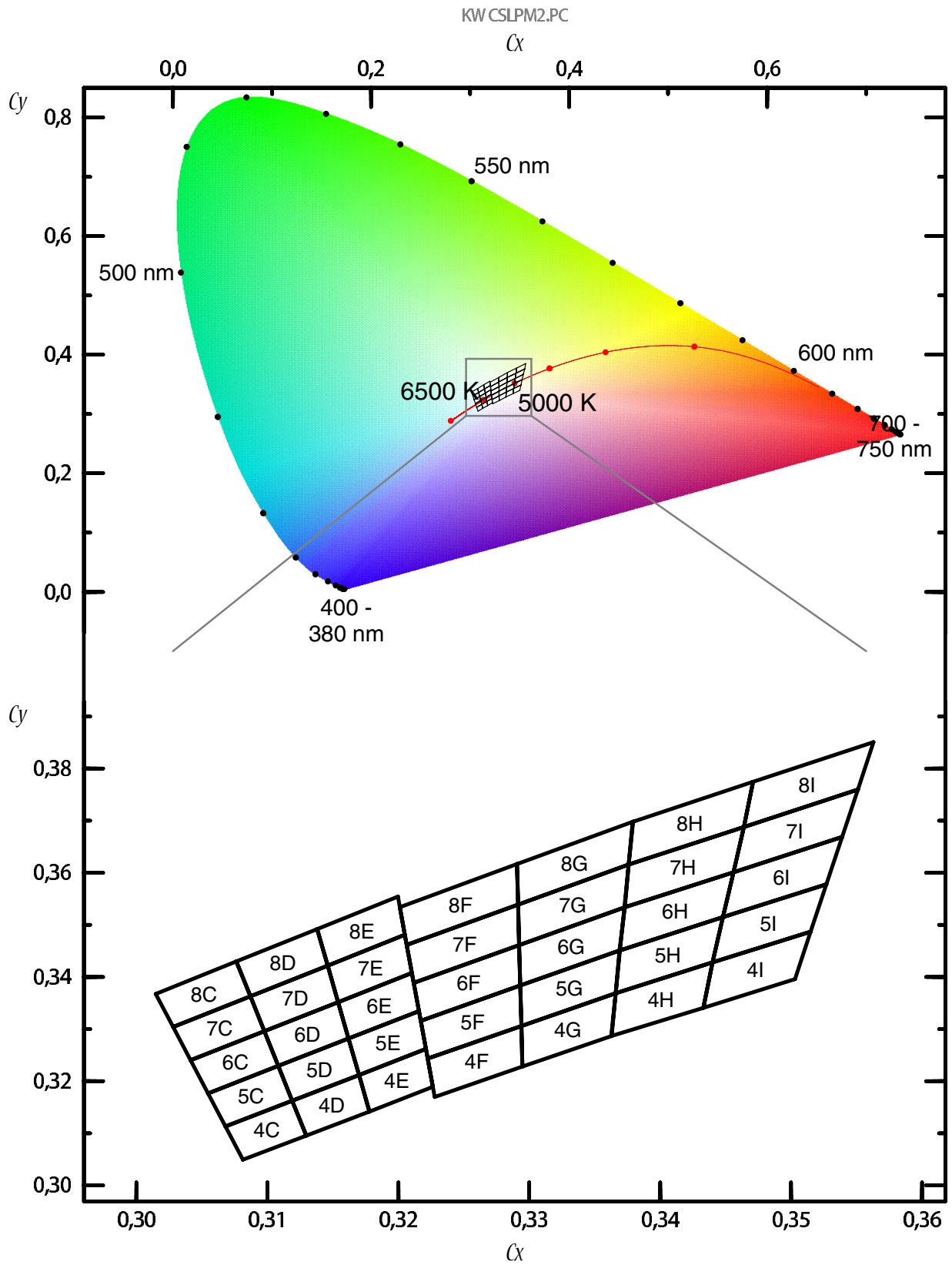

Chromaticity Coordinate Groups ³⁾

Group	Cx	Cy	CCT	Group	Cx	Cy	CCT	Group	Cx	Cy	CCT
4H	0.3363	0.3287	5000	8H	0.3376	0.3616	5000	7F	0.3212	0.3389	5700
	0.3366	0.3369	5000		0.3379	0.3698	5000		0.3206	0.3462	5700
	0.3441	0.3428	5000		0.3471	0.3775	5000		0.3292	0.3539	5700
	0.3433	0.3341	5000		0.3464	0.3688	5000		0.3292	0.3461	5700
4I	0.3433	0.3341	5000	8I	0.3464	0.3688	5000	7G	0.3292	0.3461	5700
	0.3441	0.3428	5000		0.3471	0.3775	5000		0.3292	0.3539	5700
	0.3515	0.3487	5000		0.3563	0.3851	5000		0.3376	0.3616	5700
	0.3503	0.3396	5000		0.3551	0.3760	5000		0.3373	0.3534	5700
5H	0.3366	0.3369	5000	4F	0.3228	0.3170	5700	8F	0.3206	0.3462	5700
	0.3369	0.3451	5000		0.3222	0.3243	5700		0.3201	0.3534	5700
	0.3448	0.3515	5000		0.3294	0.3306	5700		0.3291	0.3617	5700
	0.3441	0.3428	5000		0.3295	0.3228	5700		0.3292	0.3539	5700
5I	0.3441	0.3428	5000	4G	0.3295	0.3228	5700	8G	0.3292	0.3539	5700
	0.3448	0.3515	5000		0.3294	0.3306	5700		0.3291	0.3617	5700
	0.3527	0.3578	5000		0.3366	0.3369	5700		0.3379	0.3698	5700
	0.3515	0.3487	5000		0.3363	0.3287	5700		0.3376	0.3616	5700
6H	0.3369	0.3451	5000	5F	0.3222	0.3243	5700	4C	0.3081	0.3049	6500
	0.3373	0.3534	5000		0.3217	0.3316	5700		0.3068	0.3113	6500
	0.3456	0.3601	5000		0.3293	0.3384	5700		0.3119	0.3162	6500
	0.3448	0.3515	5000		0.3294	0.3306	5700		0.3130	0.3095	6500
6I	0.3448	0.3515	5000	5G	0.3294	0.3306	5700	4D	0.3130	0.3095	6500
	0.3456	0.3601	5000		0.3293	0.3384	5700		0.3119	0.3162	6500
	0.3539	0.3669	5000		0.3369	0.3451	5700		0.3170	0.3212	6500
	0.3527	0.3578	5000		0.3366	0.3369	5700		0.3178	0.3142	6500
7H	0.3373	0.3534	5000	6F	0.3217	0.3316	5700	4E	0.3178	0.3142	6500
	0.3376	0.3616	5000		0.3212	0.3389	5700		0.3170	0.3212	6500
	0.3464	0.3688	5000		0.3292	0.3461	5700		0.3221	0.3262	6500
	0.3456	0.3601	5000		0.3293	0.3384	5700		0.3226	0.3189	6500
7I	0.3456	0.3601	5000	6G	0.3293	0.3384	5700	5C	0.3068	0.3113	6500
	0.3464	0.3688	5000		0.3292	0.3461	5700		0.3055	0.3177	6500
	0.3551	0.3760	5000		0.3373	0.3534	5700		0.3108	0.3229	6500
	0.3539	0.3669	5000		0.3369	0.3451	5700		0.3119	0.3162	6500

Group	Cx	Cy	CCT	Group	Cx	Cy	CCT	Group	Cx	Cy	CCT
5D	0.3119	0.3162	6500	6E	0.3162	0.3282	6500	8C	0.3028	0.3304	6500
	0.3108	0.3229	6500		0.3154	0.3352	6500		0.3015	0.3368	6500
	0.3162	0.3282	6500		0.3210	0.3408	6500		0.3076	0.3430	6500
	0.3170	0.3212	6500		0.3216	0.3334	6500		0.3087	0.3363	6500
5E	0.3170	0.3212	6500	7C	0.3041	0.3240	6500	8D	0.3087	0.3363	6500
	0.3162	0.3282	6500		0.3028	0.3304	6500		0.3076	0.3430	6500
	0.3216	0.3334	6500		0.3087	0.3363	6500		0.3138	0.3492	6500
	0.3221	0.3262	6500		0.3098	0.3296	6500		0.3146	0.3422	6500
6C	0.3055	0.3177	6500	7D	0.3098	0.3296	6500	8E	0.3146	0.3422	6500
	0.3041	0.3240	6500		0.3087	0.3363	6500		0.3138	0.3492	6500
	0.3098	0.3296	6500		0.3146	0.3422	6500		0.3200	0.3554	6500
	0.3108	0.3229	6500		0.3154	0.3352	6500		0.3205	0.3481	6500
6D	0.3108	0.3229	6500	7E	0.3154	0.3352	6500				
	0.3098	0.3296	6500		0.3146	0.3422	6500				
	0.3154	0.3352	6500		0.3205	0.3481	6500				
	0.3162	0.3282	6500		0.3210	0.3408	6500				

Group Name on Label

Example: 5N-4C

Brightness

Color Chromaticity

5N

4C

Relative Spectral Emission ⁶⁾

$\Phi_{rel} = f(\lambda); I_F = 700 \text{ mA}; T_S = 25 \text{ }^\circ\text{C}$

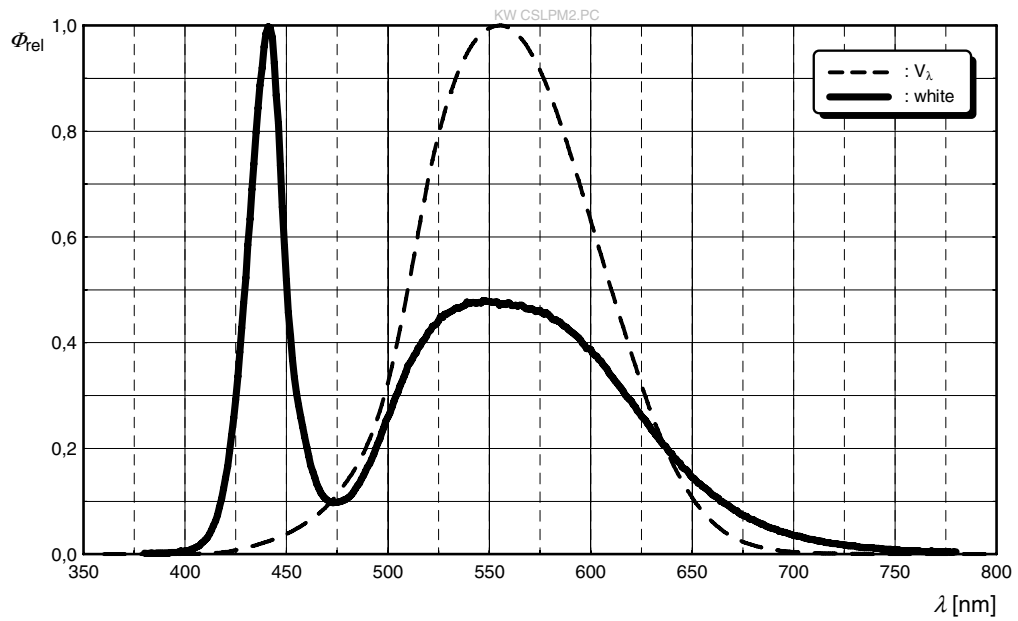

Radiation Characteristics ⁶⁾

$I_{rel} = f(\phi); T_S = 25 \text{ }^\circ\text{C}$

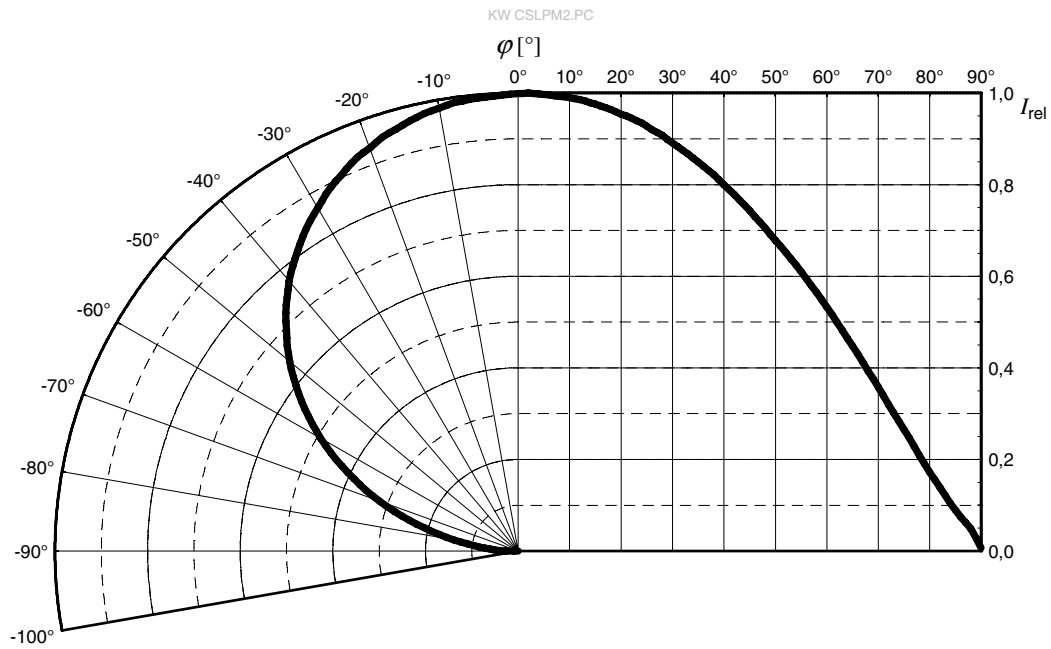

Forward current 6), 7)

$I_F = f(V_F); T_S = 25\text{ °C}$

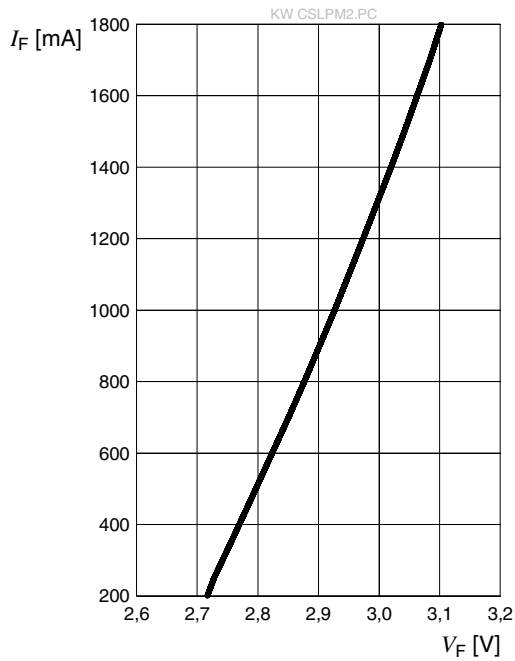

Relative Luminous Flux 6), 7)

$\Phi_V / \Phi_V(700\text{ mA}) = f(I_F); T_S = 25\text{ °C}$

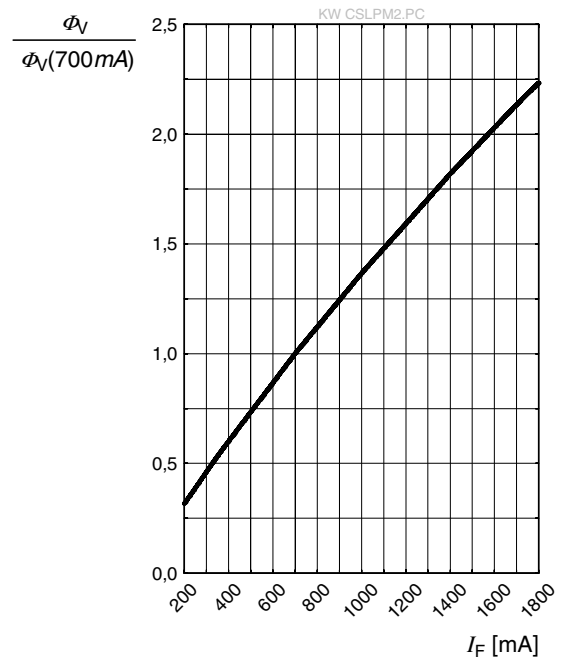

Chromaticity Coordinate Shift 6)

$\Delta Cx, \Delta Cy = f(I_F); T_S = 25\text{ °C}$

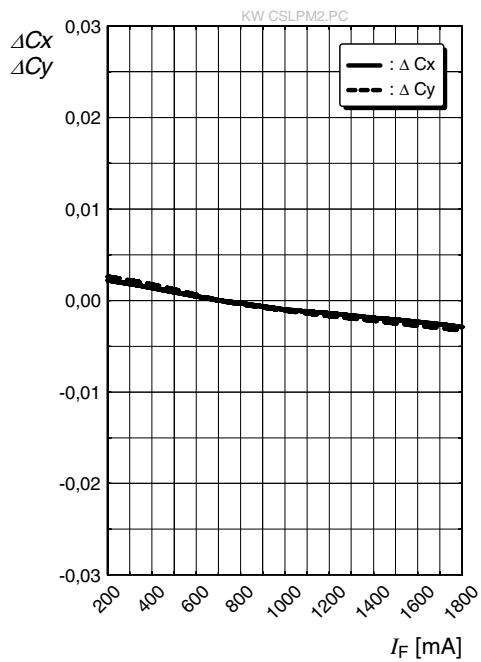

Forward Voltage ⁶⁾

$$\Delta V_F = V_F - V_F(25^\circ\text{C}) = f(T_j); I_F = 700\text{ mA}$$

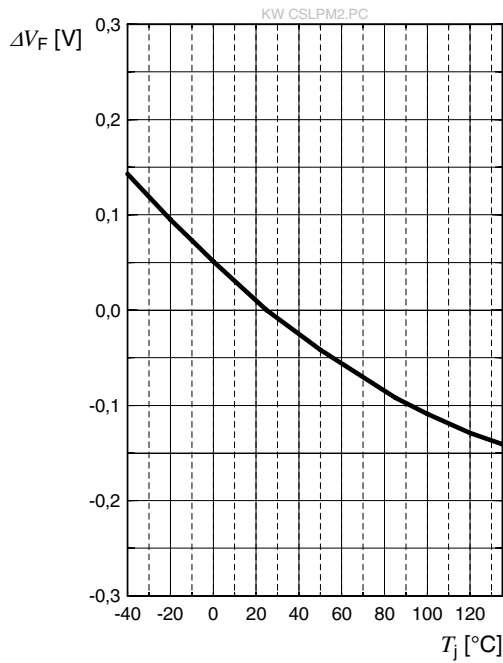

Relative Luminous Flux ⁶⁾

$$\Phi_V / \Phi_V(25^\circ\text{C}) = f(T_j); I_F = 700\text{ mA}$$

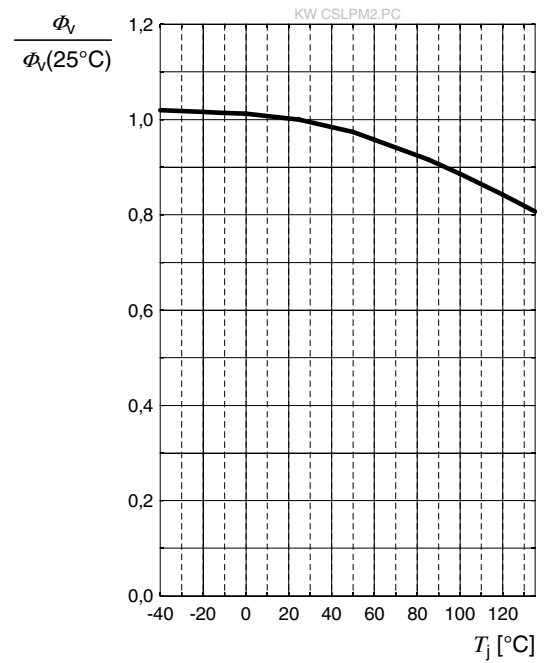

Chromaticity Coordinate Shift ⁶⁾

$$\Delta C_x, \Delta C_y = f(T_j); I_F = 700\text{ mA}$$

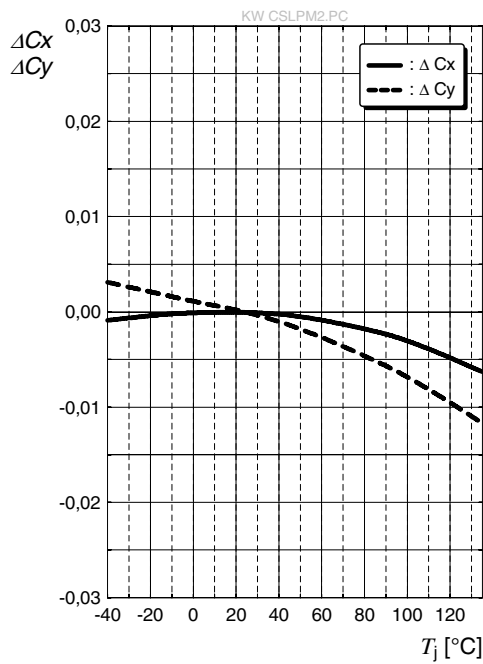

Max. Permissible Forward Current

$$I_F = f(T)$$

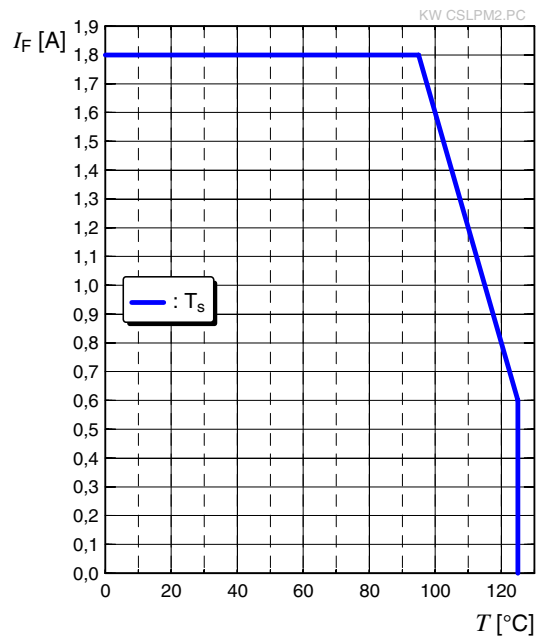

Dimensional Drawing ⁸⁾

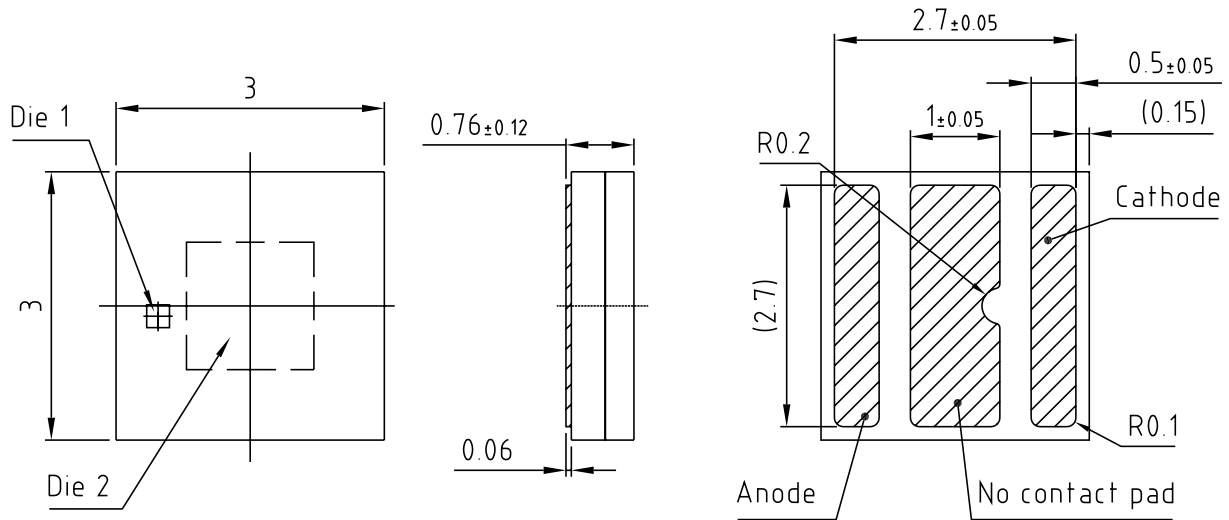

C67062-A0200-A1-02

Further Information:

Approximate Weight: 21.2 mg

Corrosion test: Class: 3B
 Test condition: 40°C / 90 % RH / 15 ppm H₂S / 14 days (stricter than IEC 60068-2-43)

ESD advice: The device is protected by ESD device which is connected in parallel to the Chip.

Electrical Internal Circuit

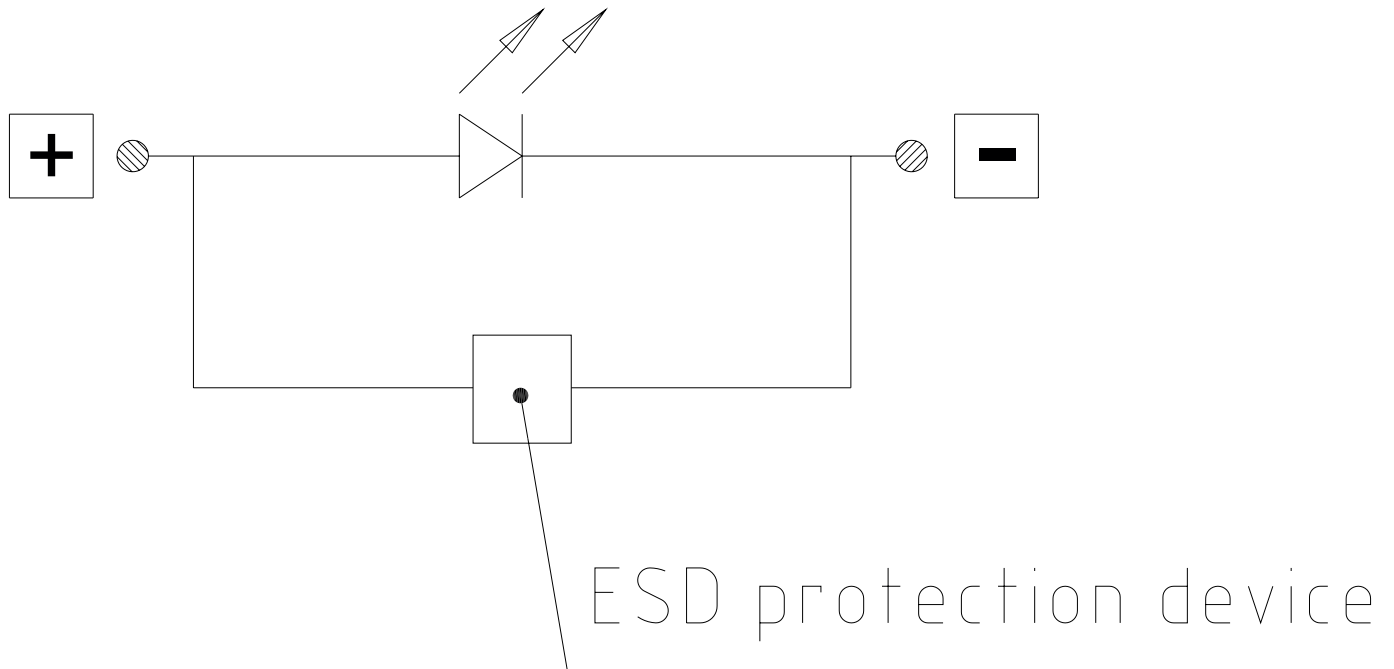

Recommended Solder Pad ⁸⁾

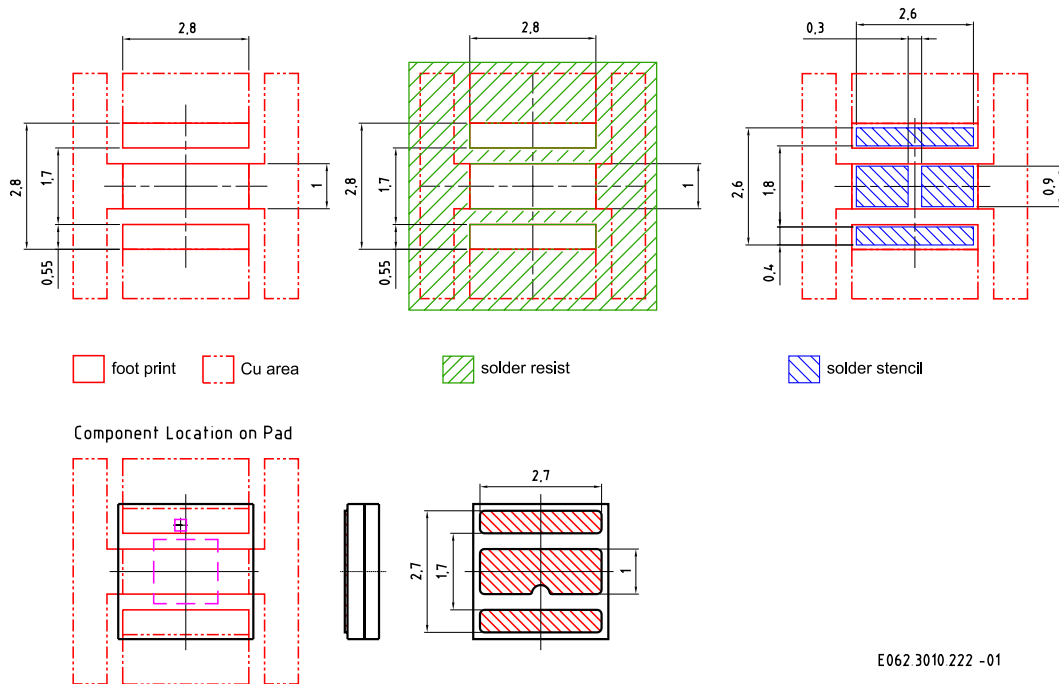

E062.3010.222 -01

For superior solder joint connectivity results we recommend soldering under standard nitrogen atmosphere. Package not suitable for ultra sonic cleaning. To ensure a high solder joint reliability and to minimize the risk of solder joint cracks, the customer is responsible to evaluate the combination of PCB board and solder paste material for his application.

Reflow Soldering Profile

Product complies to MSL Level 2 acc. to JEDEC J-STD-020E

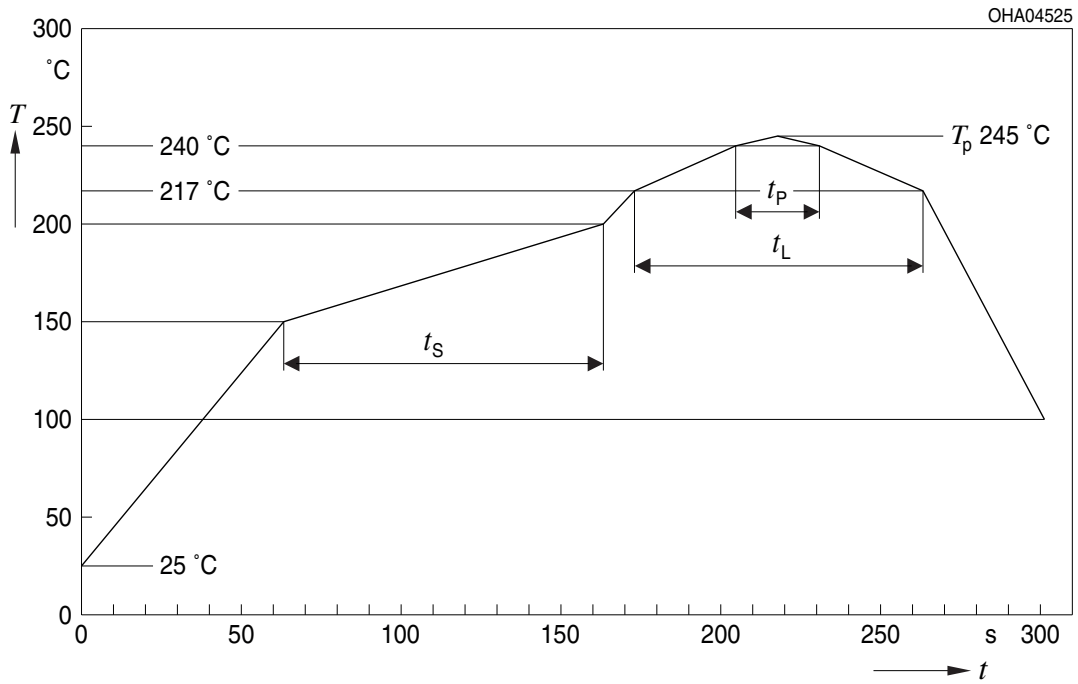

Profile Feature	Symbol	Pb-Free (SnAgCu) Assembly			Unit
		Minimum	Recommendation	Maximum	
Ramp-up rate to preheat ^{*)} 25 °C to 150 °C			2	3	K/s
Time t_s T_{Smin} to T_{Smax}	t_s	60	100	120	s
Ramp-up rate to peak ^{*)} T_{Smax} to T_p			2	3	K/s
Liquidus temperature	T_L		217		°C
Time above liquidus temperature	t_L		80	100	s
Peak temperature	T_p		245	260	°C
Time within 5 °C of the specified peak temperature $T_p - 5 \text{ K}$	t_p	10	20	30	s
Ramp-down rate* T_p to 100 °C			3	6	K/s
Time 25 °C to T_p				480	s

All temperatures refer to the center of the package, measured on the top of the component

* slope calculation DT/Dt : Dt max. 5 s; fulfillment for the whole T-range

Taping ⁸⁾

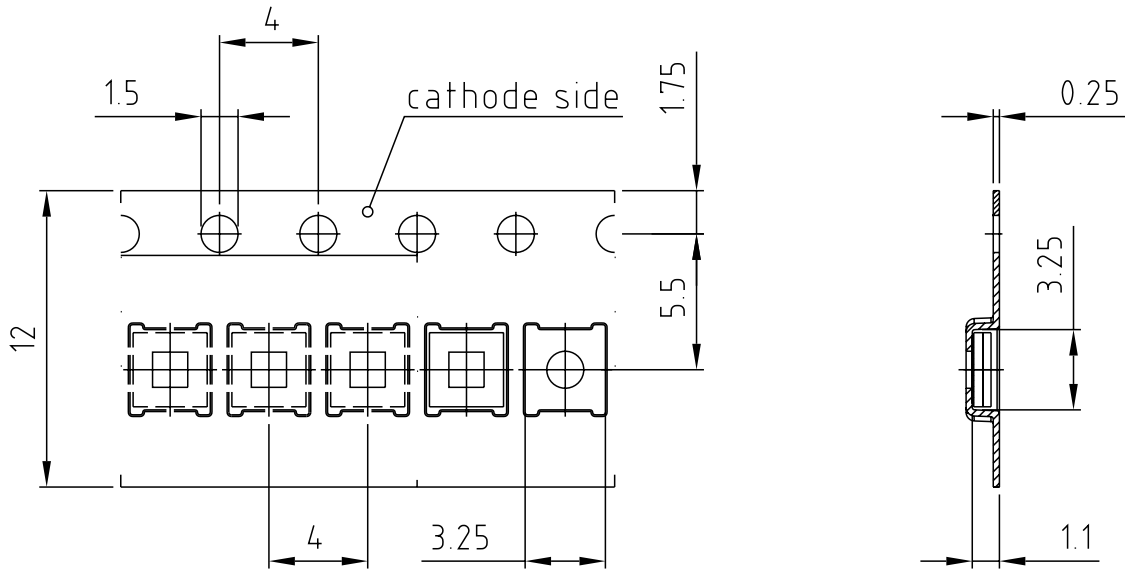

C67062-A0200-B8-02

Tape and Reel ⁹⁾

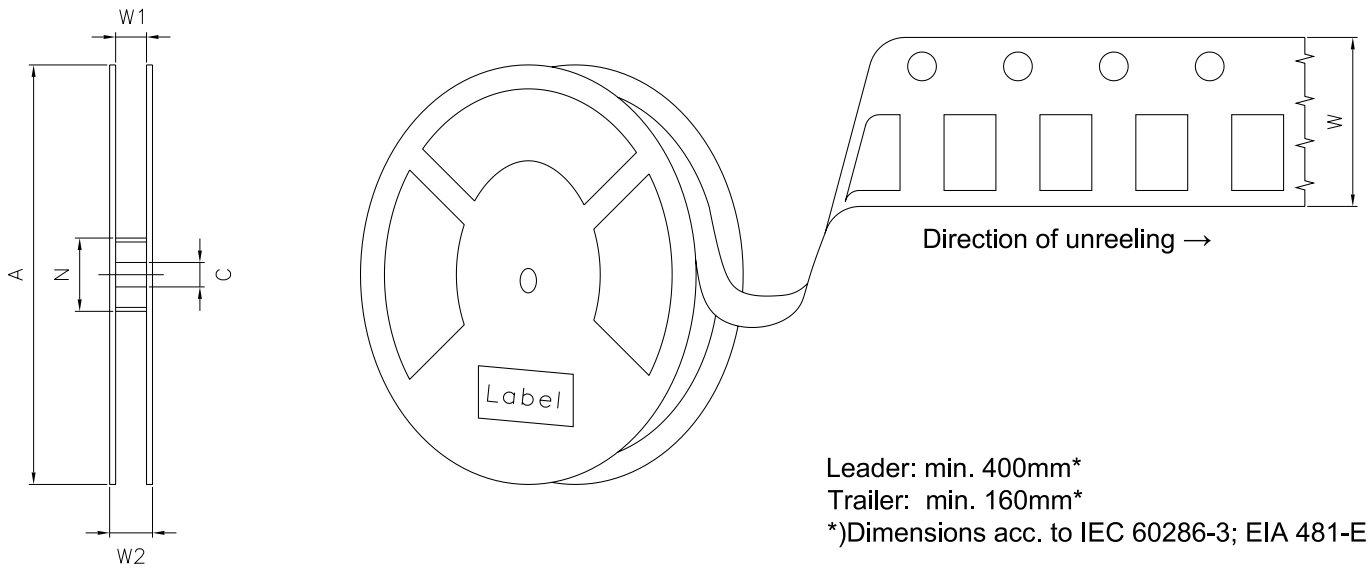

Reel Dimensions

A	W	N _{min}	W ₁	W _{2max}	Pieces per PU
180 mm	12 + 0.3 / - 0.1 mm	60 mm	12.4 + 2 mm	18.4 mm	600

Barcode-Product-Label (BPL)

OSRAM Opto Semiconductors LX XXXX BIN1: XX-XX-X-XXX-X

RoHS Compliant

(6P) BATCH NO: 1234567890 ML Temp ST
X XXX °C X

(1T) LOT NO: 1234567890 (9D) D/C: 1234

(X) PROD NO: 123456789(Q)QTY: 9999 (G) GROUP: XX-XX-X-X

Pack: RXX
DEMY XXX
X_X123_1234.1234 X



OHA04563

Dry Packing Process and Materials ⁸⁾

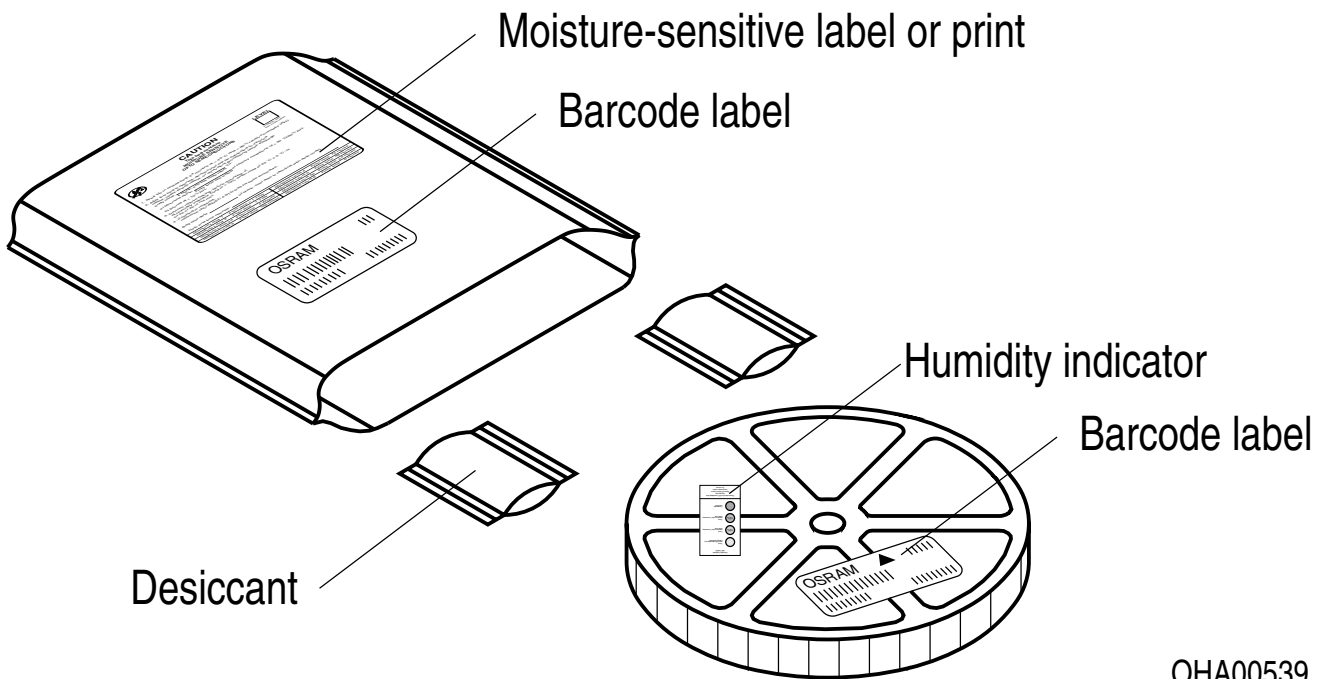

OHA00539

Moisture-sensitive product is packed in a dry bag containing desiccant and a humidity card according JEDEC-STD-033.

Notes

The evaluation of eye safety occurs according to the standard IEC 62471:2006 (photo biological safety of lamps and lamp systems). Within the risk grouping system of this IEC standard, the device specified in this data sheet falls into the class **moderate risk (exposure time 0.25 s)**. Under real circumstances (for exposure time, conditions of the eye pupils, observation distance), it is assumed that no endangerment to the eye exists from these devices. As a matter of principle, however, it should be mentioned that intense light sources have a high secondary exposure potential due to their blinding effect. When looking at bright light sources (e.g. headlights), temporary reduction in visual acuity and afterimages can occur, leading to irritation, annoyance, visual impairment, and even accidents, depending on the situation.

Subcomponents of this device contain, in addition to other substances, metal filled materials including silver. Metal filled materials can be affected by environments that contain traces of aggressive substances. Therefore, we recommend that customers minimize device exposure to aggressive substances during storage, production, and use. Devices that showed visible discoloration when tested using the described tests above did show no performance deviations within failure limits during the stated test duration. Respective failure limits are described in the IEC60810.

For further application related information please visit www.osram-os.com/appnotes

Disclaimer

Attention please!

The information describes the type of component and shall not be considered as assured characteristics. Terms of delivery and rights to change design reserved. Due to technical requirements components may contain dangerous substances.

For information on the types in question please contact our Sales Organization.

If printed or downloaded, please find the latest version on the OSRAM OS website.

Packing

Please use the recycling operators known to you. We can also help you – get in touch with your nearest sales office. By agreement we will take packing material back, if it is sorted. You must bear the costs of transport. For packing material that is returned to us unsorted or which we are not obliged to accept, we shall have to invoice you for any costs incurred.

Product and functional safety devices/applications or medical devices/applications

OSRAM OS components are not developed, constructed or tested for the application as safety relevant component or for the application in medical devices.

OSRAM OS products are not qualified at module and system level for such application.

In case buyer – or customer supplied by buyer – considers using OSRAM OS components in product safety devices/applications or medical devices/applications, buyer and/or customer has to inform the local sales partner of OSRAM OS immediately and OSRAM OS and buyer and /or customer will analyze and coordinate the customer-specific request between OSRAM OS and buyer and/or customer.

Glossary

- 1) **Brightness:** Brightness values are measured during a current pulse of typically 25 ms, with an internal reproducibility of $\pm 8\%$ and an expanded uncertainty of $\pm 11\%$ (acc. to GUM with a coverage factor of $k = 3$).
- 2) **Reverse Operation:** Reverse Operation of 10 hours is permissible in total. Continuous reverse operation is not allowed.
- 3) **Chromaticity coordinate groups:** Chromaticity coordinates are measured during a current pulse of typically 25 ms, with an internal reproducibility of ± 0.005 and an expanded uncertainty of ± 0.01 (acc. to GUM with a coverage factor of $k = 3$).
- 4) **Forward Voltage:** The forward voltage is measured during a current pulse of typically 8 ms, with an internal reproducibility of $\pm 0.05\text{ V}$ and an expanded uncertainty of $\pm 0.1\text{ V}$ (acc. to GUM with a coverage factor of $k = 3$).
- 5) **Thermal Resistance:** $R_{th\text{ max}}$ is based on statistic values (6σ).
- 6) **Typical Values:** Due to the special conditions of the manufacturing processes of semiconductor devices, the typical data or calculated correlations of technical parameters can only reflect statistical figures. These do not necessarily correspond to the actual parameters of each single product, which could differ from the typical data and calculated correlations or the typical characteristic line. If requested, e.g. because of technical improvements, these typ. data will be changed without any further notice.
- 7) **Characteristic curve:** In the range where the line of the graph is broken, you must expect higher differences between single devices within one packing unit.
- 8) **Tolerance of Measure:** Unless otherwise noted in drawing, tolerances are specified with ± 0.1 and dimensions are specified in mm.
- 9) **Tape and Reel:** All dimensions and tolerances are specified acc. IEC 60286-3 and specified in mm.

Revision History

Version	Date	Change
1.3	2019-02-07	Ordering Information Chromaticity Coordinate Groups
1.4	2020-03-23	Schematic Transportation Box Dimensions of Transportation Box

Published by OSRAM Opto Semiconductors GmbH EU RoHS and China RoHS compliant product
Leibnizstraße 4, D-93055 Regensburg
www.osram-os.com © All Rights Reserved.



此产品符合欧盟 RoHS 指令的要求；
按照中国的相关法规和标准，不含有毒有害物质或元素。