



120×120×25 mm

San Ace 120 9G type Model 9G1212B401 is not certified.

General Specifications

- Material Frame: Plastic (Flammability: UL 94V-0), Impeller: Plastic (Flammability: UL 94V-1)
- Expected life See the table below. (L10 life: 90% survival rate for continuous operation in free air at 60°C, rated voltage)
- Motor protection function Locked rotor burnout protection, Reverse polarity protection
For details, please refer to p. 547.
- Dielectric strength 50/60 Hz, 500 VAC, for 1 minute (between lead wire conductors and frame)
- Insulation resistance 10 MΩ or more with a 500 VDC megger (between lead wire conductors and frame)
- Sound pressure level (SPL) At 1 m away from the air inlet
- Storage temperature -30 to +70°C (Non-condensing)
- Lead wire ⊕Red ⊖Black or Blue (Sensor) Yellow
- Mass 240 g

Specifications

The models listed below **have ribs and pulse sensors**. For models without ribs, append "1" to the end of model numbers.

Model no.	Rated voltage [V]	Operating voltage range [V]	Rated current [A]	Rated input [W]	Rated speed [min ⁻¹]	Max. airflow [m ³ /min] [CFM]	Max. static pressure [Pa] [inchH ₂ O]	SPL [dB (A)]	Operating temperature [°C]	Expected life [h]
9G1212G401	12	10.2 to 13.8	0.9	10.8	4100	3.68 130	120 0.482	51	-20 to +70	40000/60°C
9G1212E401			0.58	6.96	3650	3.25 115	98 0.394	48		
9G1212A401			0.4	4.8	3150	2.83 100	77 0.309	44		
9G1212H401		6 to 13.8	0.31	3.72	2850	2.5 88	64 0.257	40		
9G1212F401		7 to 13.8	0.19	2.28	2250	1.98 70	42 0.169	35		
9G1212M401			0.14	1.68	1950	1.66 59	31 0.124	29		
9G1212B401		10.2 to 13.8	0.06	0.72	1000	0.88 31	9.6 0.039	18		
9G1224G401	24	20.4 to 27.6	0.47	11.28	4100	3.68 130	120 0.482	51		
9G1224E401			0.37	8.88	3650	3.25 115	98 0.394	48		
9G1224A401			0.21	5.04	3150	2.83 100	77 0.309	44		
9G1224H401		12 to 27.6	0.17	4.08	2850	2.5 88	64 0.257	40		
9G1224F401		20.4 to 27.6	0.1	2.4	2250	1.98 70	42 0.169	35		
9G1224M401			0.08	1.92	1950	1.66 59	31 0.124	29		
9G1248G401		48	40.8 to 55.2	0.23	11.04	4100	3.68 130	120 0.482		
9G1248E401	0.16			7.68	3650	3.25 115	98 0.394	48		
9G1248A401	0.13			6.24	3150	2.83 100	77 0.309	44		
9G1248H401	0.1			4.8	2850	2.5 88	64 0.257	40		
9G1248F401	0.06			2.88	2250	1.98 70	42 0.169	35		
9G1248M401	0.05			2.4	1950	1.66 59	31 0.124	29		

The following sensor and control options are available for selection.

Differs according to the model. Refer to the table on pp. 568 to 570. Without sensor Lock sensor PWM control

Airflow - Static Pressure Characteristics

9G1212G401 With pulse sensor

Operating voltage range



9G1212E401 With pulse sensor

Operating voltage range



9G1212A401 With pulse sensor

Operating voltage range

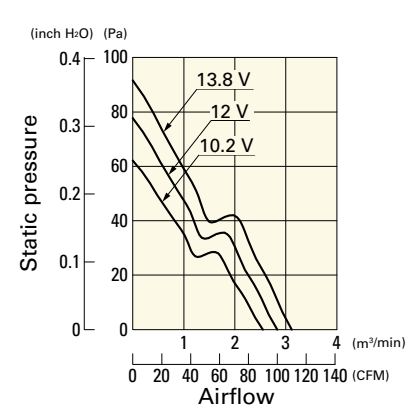

Airflow - Static Pressure Characteristics

9G1212H401 With pulse sensor

Operating voltage range



9G1212F401 With pulse sensor

Operating voltage range



9G1212M401 With pulse sensor

Operating voltage range



9G1212B401 With pulse sensor

Operating voltage range



9G1224G401 With pulse sensor

Operating voltage range



9G1224E401 With pulse sensor

Operating voltage range



9G1224A401 With pulse sensor

Operating voltage range



9G1224H401 With pulse sensor

Operating voltage range



9G1224F401 With pulse sensor

Operating voltage range



9G1224M401 With pulse sensor

Operating voltage range



9G1248G401 With pulse sensor

Operating voltage range



9G1248E401 With pulse sensor

Operating voltage range

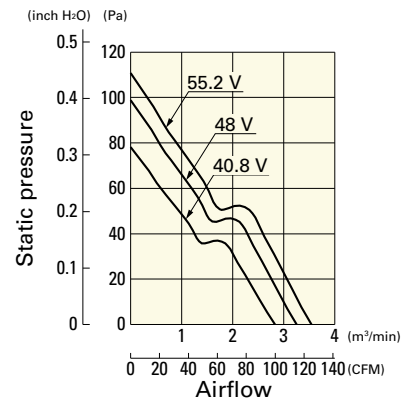

Airflow - Static Pressure Characteristics

9G1248A401 With pulse sensor

Operating voltage range

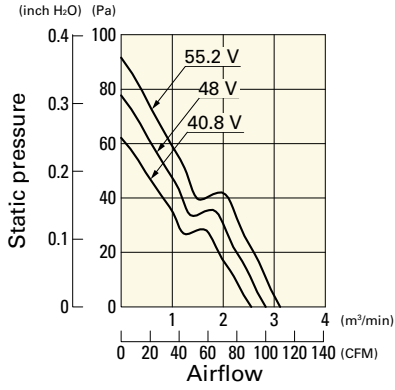

9G1248H401 With pulse sensor

Operating voltage range

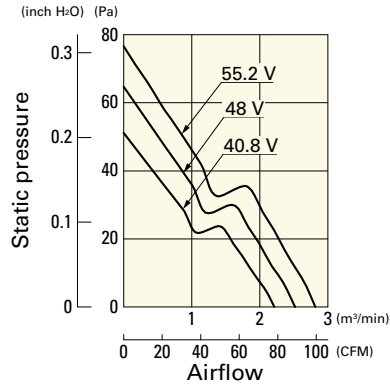

9G1248F401 With pulse sensor

Operating voltage range

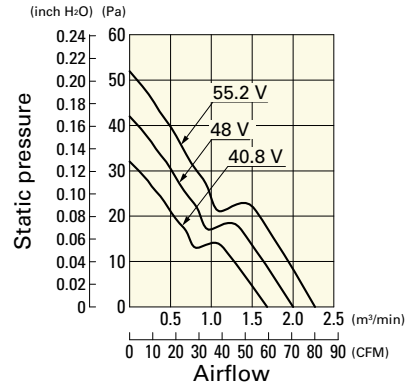

9G1248M401 With pulse sensor

Operating voltage range

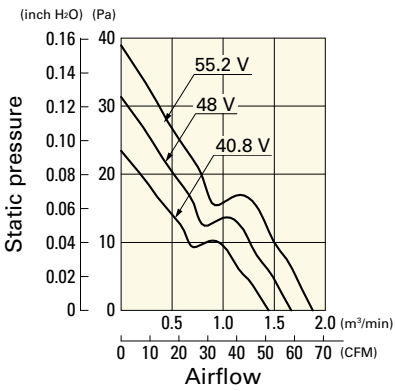

Dimensions (unit: mm) (With ribs)

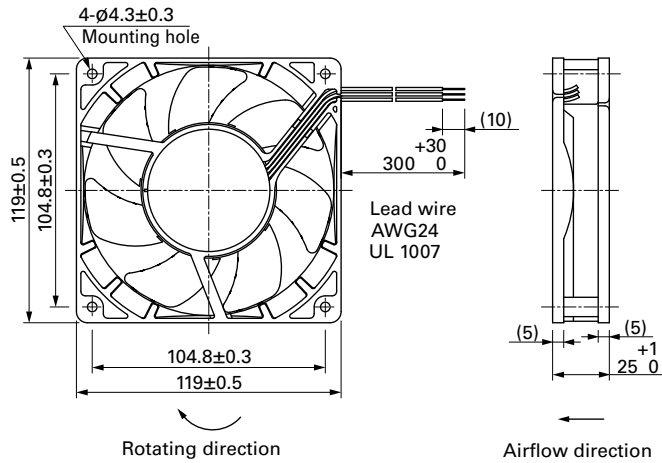

Reference Dimensions of Mounting Holes and Vent Opening (unit: mm)



Options

Finger guards

page: p. 533

Model no.: 109-019E, 109-019K, 109-019C, 109-019H

Resin finger guards

page: p. 539

Model no.: 109-1000G

Resin filter kits

page: p. 540

Model no.: 109-1000F13 (13PPI), 109-1000F20 (20PPI),
109-1000F30 (30PPI), 109-1000F40 (40PPI)