

NOTES:

1. Material : Stainless Steel
2. Finish : Glod Irridite
3. Ends : Closed and Ground
4. Total Coils : 10.000
5. Sugg. Max. Deflection : 0.490 (in)
6. Sugg. Max. Load : 2.300 (lbs)
7. All Drawing Dimensions are in Inches [mm]

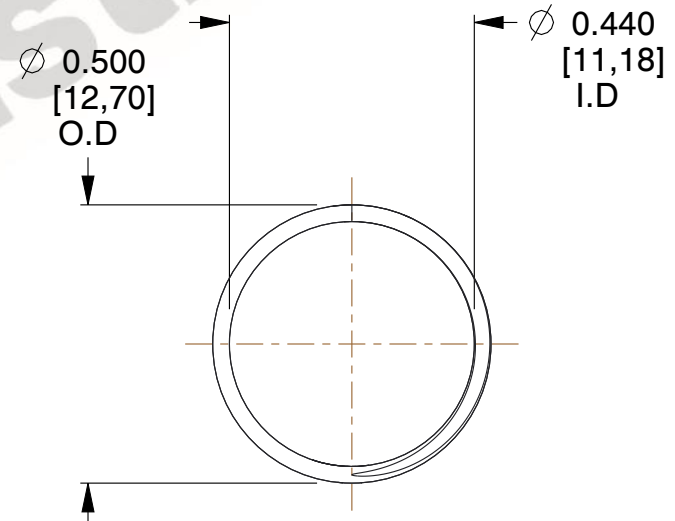
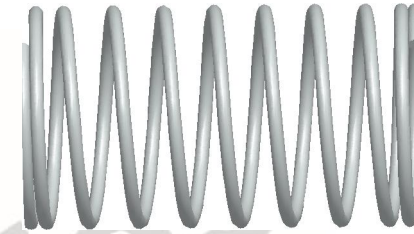

| COMPONENT | | SPRINGS | |
|---|--|---------|-----------|
| 11772 COMPRESSION SPRINGS | | UNIT | INCH [mm] |
| | | SHEET | 1 of 1 |
| | | | |